



STTH60L06C

TURBO 2 ULTRAFast HIGH VOLTAGE RECTIFIER

Table 1: Main Product Characteristics

$I_{F(AV)}$	Up to 2 x 40 A
V_{RRM}	600 V
T_j	175°C
V_F (typ)	1.0 V
t_{rr} (max)	65 ns

FEATURES AND BENEFITS

- Ultrafast switching
- Low reverse current
- Low thermal resistance
- Reduces switching & conduction losses

DESCRIPTION

The STTH60L06, which is using ST Turbo 2 600V technology, is specially suited for use in switching power supplies, and industrial applications, as rectification and discontinuous mode PFC boost diode.

Table 2: Order Codes

Part Number	Marking
STTH60L06CW	STTH60L06CW

Table 3: Absolute Ratings (limiting values, per diode)

Symbol	Parameter		Value	Unit
V_{RRM}	Repetitive peak reverse voltage		600	V
$I_{F(RMS)}$	RMS forward current		60	A
$I_{F(AV)}$	Average forward current $\delta = 0.5$	$T_c = 125^\circ\text{C}$ Per diode	30	A
		$T_c = 110^\circ\text{C}$ Per device	60	
		$T_c = 100^\circ\text{C}$ Per diode	40	
		$T_c = 80^\circ\text{C}$ Per device	80	
I_{FSM}	Surge non repetitive forward current	$t_p = 10\text{ms}$ sinusoidal	210	A
T_{stg}	Storage temperature range		-65 to + 175	°C
T_j	Maximum operating junction temperature		175	°C

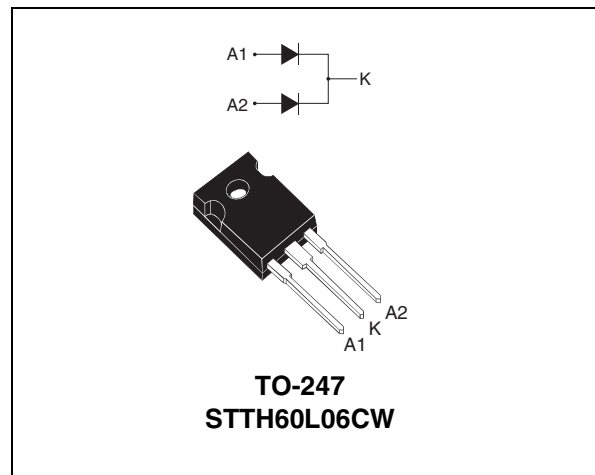

Table 4: Thermal Resistance

Symbol	Parameter		Value (max).	Unit
$R_{th(j-c)}$	Junction to case	Per diode	1.05	°C/W
		Total	0.68	
$R_{th(c)}$	Coupling		0.3	°C/W

When the diodes 1 and 2 are used simultaneously:
 $\Delta T_{j(\text{diode } 1)} = P(\text{diode } 1) \times R_{th(j-c)}(\text{Per diode}) + P(\text{diode } 2) \times R_{th(c)}$

Table 5: Static Electrical Characteristics (per diode)

Symbol	Parameter	Test conditions		Min.	Typ	Max.	Unit
I_R^*	Reverse leakage current	$T_j = 25^\circ\text{C}$	$V_R = V_{RRM}$			25	μA
		$T_j = 150^\circ\text{C}$			80	800	
V_F^{**}	Forward voltage drop	$T_j = 25^\circ\text{C}$	$I_F = 30\text{A}$			1.55	V
		$T_j = 150^\circ\text{C}$			1.0	1.25	
		$T_j = 25^\circ\text{C}$	$I_F = 60\text{A}$			1.78	
		$T_j = 150^\circ\text{C}$			1.24	1.55	

Pulse test: * $t_p = 5 \text{ ms}$, $\delta < 2\%$
 ** $t_p = 380 \mu\text{s}$, $\delta < 2\%$

To evaluate the conduction losses use the following equation: $P = 0.95 \times I_{F(AV)} + 0.010 I_F^2(\text{RMS})$

Table 6: Dynamic Characteristics (per diode)

Symbol	Parameter	Test conditions		Min.	Typ	Max.	Unit
t_{rr}	Reverse recovery time	$T_j = 25^\circ\text{C}$	$I_F = 0.5\text{A}$ $I_{rr} = 0.25\text{A}$ $I_R = 1\text{A}$			65	ns
			$I_F = 1\text{A}$ $di_F/dt = 50 \text{ A}/\mu\text{s}$ $V_R = 30\text{V}$		65	90	
I_{RM}	Reverse recovery current	$T_j = 125^\circ\text{C}$	$I_F = 30\text{A}$ $V_R = 400\text{V}$ $di_F/dt = 100 \text{ A}/\mu\text{s}$		11.5	16	A
t_{fr}	Forward recovery time	$T_j = 25^\circ\text{C}$	$I_F = 30\text{A}$ $di_F/dt = 100 \text{ A}/\mu\text{s}$ $V_{FR} = 1.1 \times V_{Fmax}$			500	ns
V_{FP}	Forward recovery voltage	$T_j = 25^\circ\text{C}$	$I_F = 30\text{A}$ $di_F/dt = 100 \text{ A}/\mu\text{s}$ $V_{FR} = 1.1 \times V_{Fmax}$		2.5		V

Figure 1: Conduction losses versus average forward current (per diode)

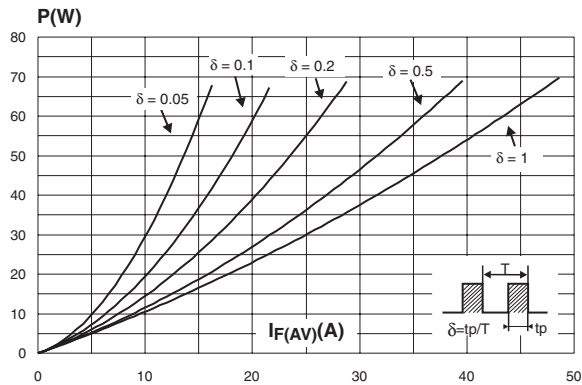

Figure 2: Forward voltage drop versus forward current (per diode)

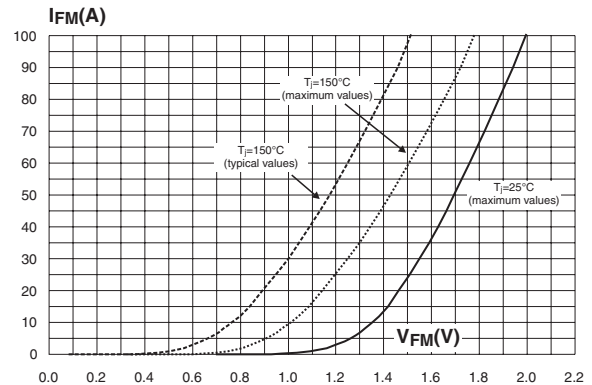

Figure 3: Relative variation of thermal impedance junction to case versus pulse duration

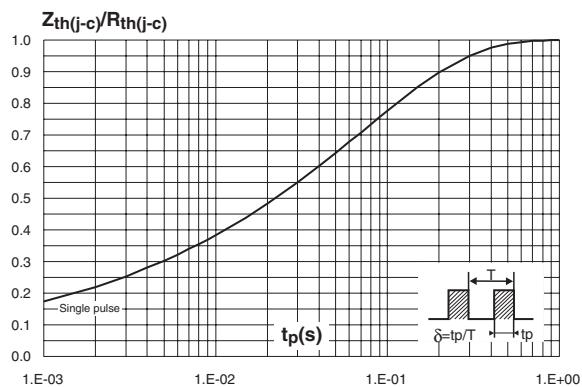

Figure 4: Peak reverse recovery current versus di/dt (typical values, per diode)

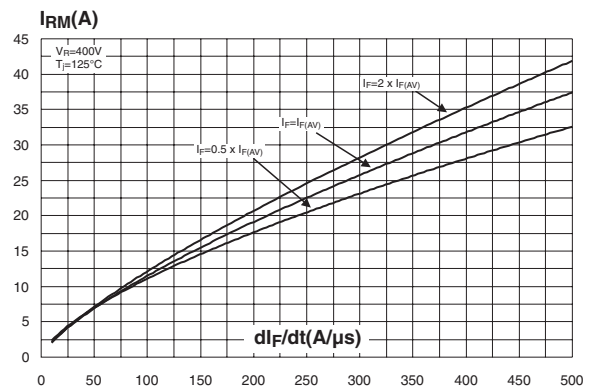

Figure 5: Reverse recovery time versus di/dt (typical values, per diode)

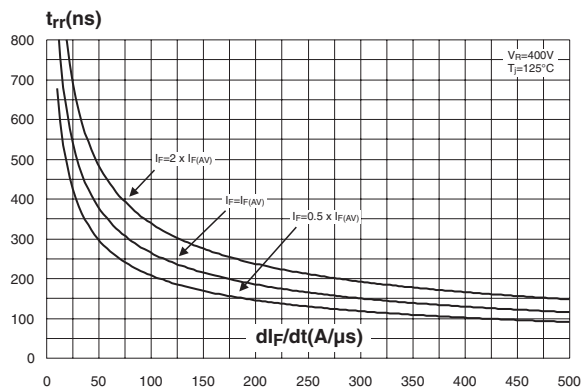

Figure 6: Reverse recovery charges versus di/dt (typical values, per diode)

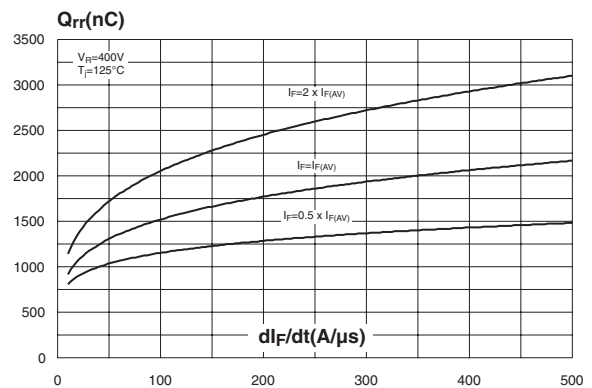

Figure 7: Reverse recovery softness factor versus di_F/dt (typical values, per diode)

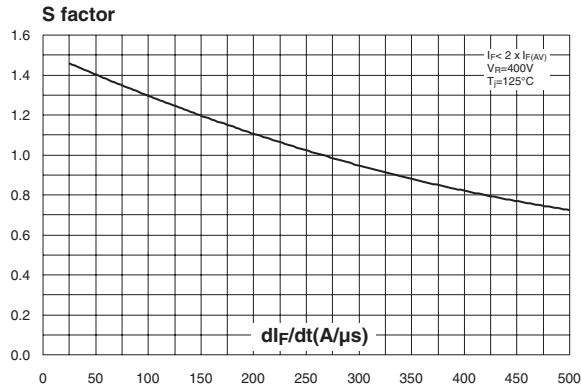

Figure 8: Relative variations of dynamic parameters versus junction temperature

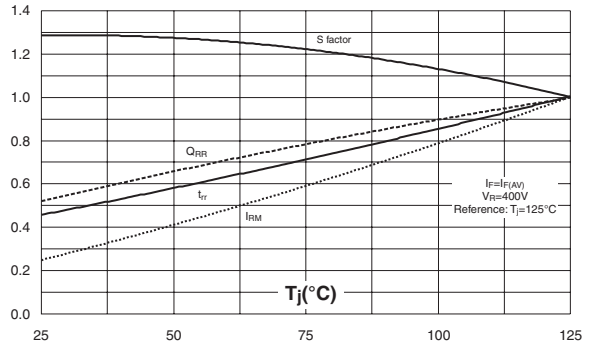

Figure 9: Transient peak forward voltage versus di_F/dt (typical values, per diode)

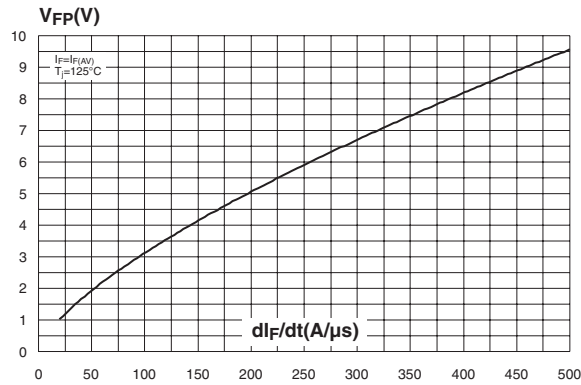

Figure 10: Forward recovery time versus di_F/dt (typical values, per diode)

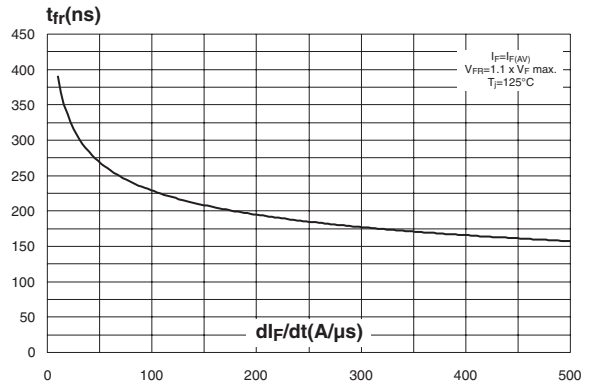

Figure 11: Junction capacitance versus reverse voltage applied (typical values, per diode)

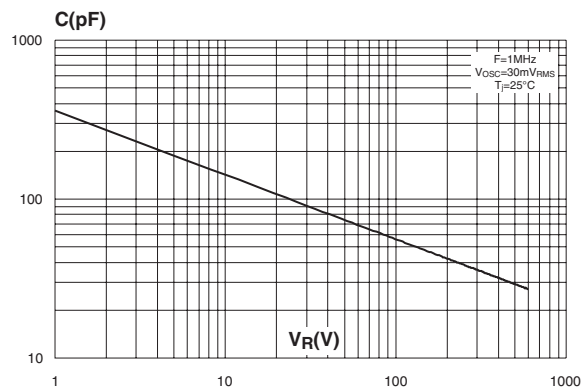

Figure 12: TO-247 Package Mechanical Data

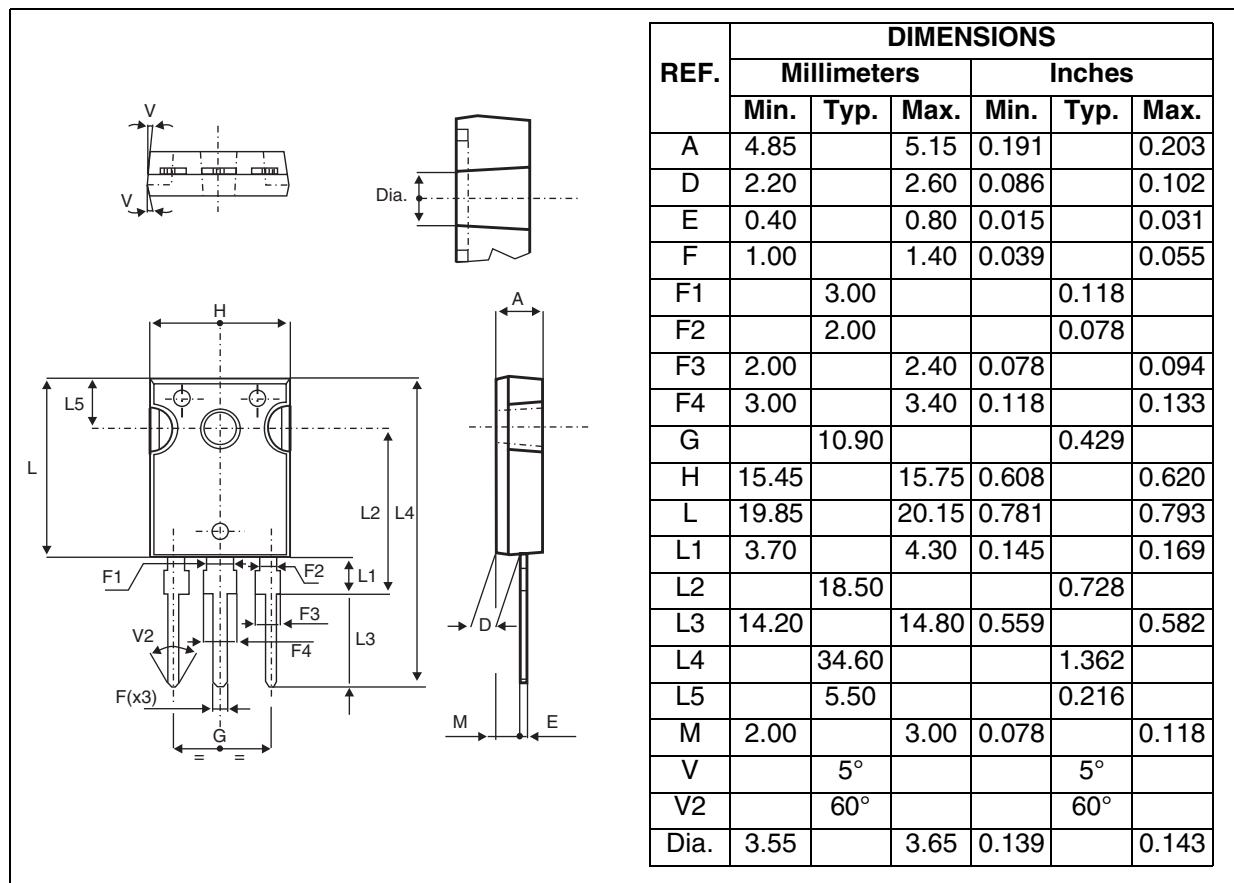

Table 7: Ordering Information

Ordering type	Marking	Package	Weight	Base qty	Delivery mode
STTH60L06CW	STTH60L06CW	TO-247	4.46 g	50	Tube

- Epoxy meets UL94, V0
- Cooling method: by conduction (C)
- Recommended torque value: 0.8 m.N.
- Maximum torque value: 1.0 m.N.

Table 8: Revision History

Date	Revision	Description of Changes
07-Sep-2004	1	First issue

Information furnished is believed to be accurate and reliable. However, STMicroelectronics assumes no responsibility for the consequences of use of such information nor for any infringement of patents or other rights of third parties which may result from its use. No license is granted by implication or otherwise under any patent or patent rights of STMicroelectronics. Specifications mentioned in this publication are subject to change without notice. This publication supersedes and replaces all information previously supplied. STMicroelectronics products are not authorized for use as critical components in life support devices or systems without express written approval of STMicroelectronics.

The ST logo is a registered trademark of STMicroelectronics.
All other names are the property of their respective owners

© 2004 STMicroelectronics - All rights reserved

STMicroelectronics group of companies

Australia - Belgium - Brazil - Canada - China - Czech Republic - Finland - France - Germany - Hong Kong - India - Israel - Italy - Japan - Malaysia - Malta - Morocco - Singapore - Spain - Sweden - Switzerland - United Kingdom - United States of America

www.st.com