

R47, Class X1, 440 VAC, 110°C (Automotive Grade)

Overview

The R47 is constructed of metallized polypropylene film encapsulated with self-extinguishing resin in a box of material meeting the requirements of UL 94 V-0.

Automotive Grade devices meet the demanding Automotive Electronics Council's AEC-Q200 qualification requirements.

Applications

For use as a electromagnetic interference (EMI) suppression filter in across-the-line applications requiring X1 safety classification. Intended for use in situations where exposure to a shock in the event of capacitor failure is not possible. X1 classified capacitors are for use only in a permanently connected apparatus with a connection to mains which cannot be loosened without the use of a tool.

Benefits

- Approvals: ENEC, UL, cUL
- Class X1 (IEC 60384-14)
- THB Grade IB
- Rated voltage: 440 VAC 50/60 Hz
- Capacitance range: 0.0047 – 2.2 μ F
- Lead spacing: 10.0 – 37.5 mm
- Capacitance tolerance: \pm 20%, \pm 10%
- Climatic category: 40/110/56, IEC 60068-1
- Tape and reel in accordance with IEC 60286-2
- RoHS Compliant and lead-free terminations
- Operating temperature range of -40°C to +110°C
- 100% screening factory test at 2,700 VDC/1,700 VAC
- Self-healing properties
- Automotive (AEC-Q200) grade

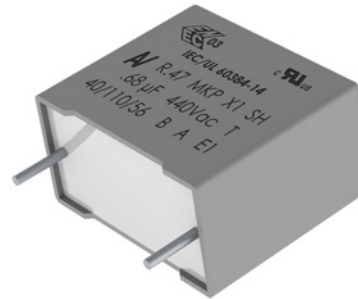

Part Number System

R47	4	I	2100	00	A1	M	V057
Series	Rated Voltage (VAC)	Lead Spacing (mm)	Capacitance Code (pF)	Packaging	Internal Use	Capacitance Tolerance	C-Spec
X1, Metallized Polypropylene	4 = 440	F = 10.0 I = 15.0 N = 22.5 R = 27.5 W = 37.5	The last three digits represent significant figures. The first digit specifies number of zeros to be added.	See Ordering Options Table	A1 A2 A3	K = \pm 10% M = \pm 20%	V057 = Standard (Grade IB and AEC-Q200)

Ordering Options Table

Lead Spacing Nominal (mm)	Type of Leads and Packaging	Lead Length (mm)	Lead and Packaging Code
10, 15, 22.5	Standard Lead and Packaging Options		
	Bulk (Bag) – Short Leads	4 +2/-0	00
	Ammo Pack	H ₀ = 18.5 ±0.5	DQ
	Other Lead and Packaging Options		
	Tape & Reel (Large Reel)	H ₀ = 18.5 ±0.5	CK
	Bulk (Bag) – Short Leads	3.5 +0.5/-0	JB
	Bulk (Bag) – Short Leads	4.0 +0.5/-0	JE
	Bulk (Bag) – Short Leads	3.2 +0.3/-0	JH
	Bulk (Bag) – Long Leads	18 ±1	JM
	Bulk (Bag) – Long Leads	30 +5/-0	40
Bulk (Bag) – Long Leads	25 +2/-1	50	
27.5	Standard Lead and Packaging Options		
	Bulk (Tray) – Short Leads	4 +2/-0	00
	Tape & Reel (Large Reel)	H ₀ = 18.5 ±0.5	CK ¹
	Other Lead and Packaging Options		
	Bulk (Tray) – Short Leads	3.5 +0.5/-0	JB
	Bulk (Tray) – Short Leads	4.0 +0.5/-0	JE
	Bulk (Tray) – Short Leads	3.2 +0.3/-0	JH
	Bulk (Tray) – Long Leads	18 ±1	JM
	Bulk (Tray) – Long Leads	30 +5/-0	40
	Bulk (Tray) – Long Leads	25 +2/-1	50
37.5	Standard Lead and Packaging Options		
	Bulk (Tray) – Short Leads	4 +2/-0	00
	Other Lead and Packaging Options		
	Bulk (Tray) – Short Leads	2.7 +0.5/-0	JA
	Bulk (Tray) – Short Leads	3.5 +0.5/-0	JB
	Bulk (Tray) – Short Leads	4.0 +0.5/-0	JE
	Bulk (Tray) – Short Leads	3.2 +0.3/-0	JH
	Bulk (Tray) – Long Leads	18 ±1	JM
	Bulk (Tray) – Long Leads	30 +5/-0	40
	Bulk (Tray) – Long Leads	25 +2/-1	50

¹ Not for all sizes, see "Packaging Quantities" table

Dimensions – Millimeters

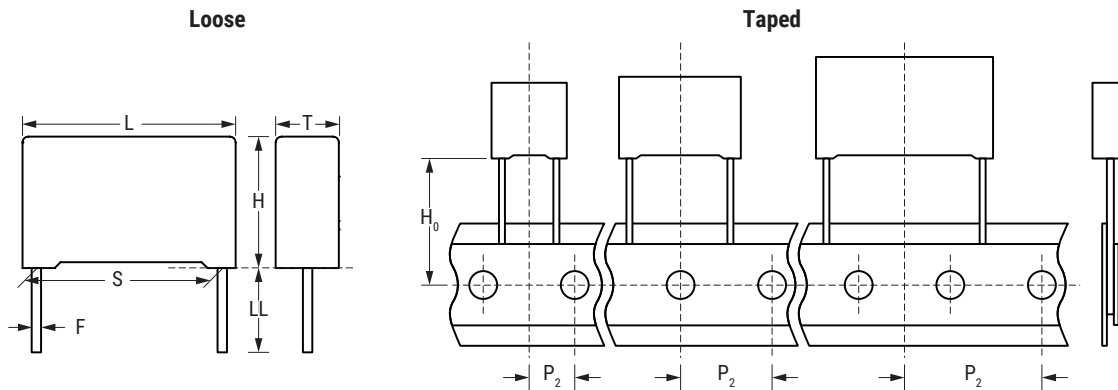

S		T		H		L		F	
Nominal	Tolerance	Nominal	Tolerance	Nominal	Tolerance	Nominal	Tolerance	Nominal	Tolerance
10.0	±0.4	4.0	+0.2/-0.5	9.0	+0.1/-0.5	13.0	+0.2/-0.5	0.6	±0.05
10.0	±0.4	5.0	+0.2/-0.5	11.0	+0.1/-0.5	13.0	+0.2/-0.5	0.6	±0.05
10.0	±0.4	6.0	+0.2/-0.5	12.0	+0.1/-0.5	13.0	+0.2/-0.5	0.6	±0.05
15.0	±0.4	5.0	+0.2/-0.5	11.0	+0.1/-0.5	18.0	+0.3/-0.5	0.6	±0.05
15.0	±0.4	6.0	+0.2/-0.5	12.0	+0.1/-0.5	18.0	+0.3/-0.5	0.6	±0.05
15.0	±0.4	6.0	+0.2/-0.5	17.5	+0.1/-0.5	18.0	+0.3/-0.5	0.6	±0.05
15.0	±0.4	7.5	+0.2/-0.5	13.5	+0.1/-0.5	18.0	+0.5/-0.5	0.6	±0.05
15.0	±0.4	7.5	+0.2/-0.5	18.5	+0.1/-0.5	18.0	+0.5/-0.5	0.8	±0.05
15.0	±0.4	8.5	+0.2/-0.5	14.5	+0.1/-0.5	18.0	+0.5/-0.5	0.6	±0.05
15.0	±0.4	9.0	+0.2/-0.5	12.5	+0.1/-0.5	18.0	+0.5/-0.5	0.6	±0.05
15.0	±0.4	10.0	+0.2/-0.5	16.0	+0.1/-0.5	18.0	+0.5/-0.5	0.8	±0.05
15.0	±0.4	11.0	+0.2/-0.5	19.0	+0.1/-0.5	18.0	+0.5/-0.5	0.8	±0.05
15.0	±0.4	13.0	+0.2/-0.5	12.0	+0.1/-0.5	18.0	+0.5/-0.5	0.8	±0.05
22.5	±0.4	6.0	+0.2/-0.5	15.0	+0.1/-0.5	26.5	+0.3/-0.5	0.8	±0.05
22.5	±0.4	6.5	+0.2/-0.5	13.5	+0.1/-0.5	26.5	+0.3/-0.5	0.8	±0.05
22.5	±0.4	7.0	+0.2/-0.5	16.0	+0.1/-0.5	26.5	+0.3/-0.5	0.8	±0.05
22.5	±0.4	8.5	+0.2/-0.5	17.0	+0.1/-0.5	26.5	+0.3/-0.5	0.8	±0.05
22.5	±0.4	10.0	+0.2/-0.5	18.5	+0.1/-0.5	26.5	+0.3/-0.5	0.8	±0.05
22.5	±0.4	11.0	+0.2/-0.5	20.0	+0.1/-0.5	26.5	+0.3/-0.5	0.8	±0.05
22.5	±0.4	13.0	+0.2/-0.5	22.0	+0.1/-0.5	26.5	+0.3/-0.5	0.8	±0.05
27.5	±0.4	9.0	+0.2/-0.7	17.0	+0.1/-0.7	32.0	+0.3/-0.7	0.8	±0.05
27.5	±0.4	11.0	+0.2/-0.7	20.0	+0.1/-0.7	32.0	+0.3/-0.7	0.8	±0.05
27.5	±0.4	13.0	+0.2/-0.7	22.0	+0.1/-0.7	32.0	+0.3/-0.7	0.8	±0.05
27.5	±0.4	14.0	+0.2/-0.7	28.0	+0.1/-0.7	32.0	+0.3/-0.7	0.8	±0.05
27.5	±0.4	18.0	+0.2/-0.7	33.0	+0.1/-0.7	32.0	+0.3/-0.7	0.8	±0.05
27.5	±0.4	22.0	+0.2/-0.7	37.0	+0.1/-0.7	32.0	+0.3/-0.7	0.8	±0.05
37.5	±0.4	11.0	+0.3/-0.7	22.0	+0.1/-0.7	41.5	+0.3/-0.7	1.0	±0.05
37.5	±0.4	13.0	+0.3/-0.7	24.0	+0.1/-0.7	41.5	+0.3/-0.7	1.0	±0.05
37.5	±0.4	16.0	+0.3/-0.7	28.5	+0.1/-0.7	41.5	+0.3/-0.7	1.0	±0.05
37.5	±0.4	19.0	+0.3/-0.7	32.0	+0.1/-0.7	41.5	+0.3/-0.7	1.0	±0.05
37.5	±0.4	20.0	+0.3/-0.7	40.0	+0.1/-0.7	41.5	+0.3/-0.7	1.0	±0.05

Note: See Ordering Options Table for lead length (LL/H₀) options.

Performance Characteristics

Dielectric	Polypropylene film		
Plates	Metal layer deposited by evaporation under vacuum		
Winding	Non-inductive type		
Leads	Tinned wire		
Protection	Plastic case, thermosetting resin filled. Box material is solvent resistant and flame retardant according to UL94.		
Related documents	IEC 60384-14, EN 60384-14		
Rated Voltage (V_R)	440 VAC (50/60 Hz)		
Recommended DC Voltage	1,000 VDC		
Capacitance Range	0.0047 – 2.2 μ F		
Capacitance Values	E6/E12 series (IEC 60063)		
Capacitance Tolerance	\pm 10%, \pm 20%		
Temperature Range	-40° to +110°C		
Climatic Category	40/110/56 IEC 60068-1		
Storage Conditions	Storage time: \leq 24 months from the date marked on the label package		
	Average relative humidity per year \leq 70%		
	RH \leq 85% for 30 days randomly distributed throughout the year		
	Dew is absent		
	Temperature: -40 to 80°C (see "Maximum Humidity in Storage Conditions" graph below)		
Approvals	ENEC, UL, cUL		
Dissipation Factor ($\tan\delta$) at 1 kHz	Maximum Values at +25°C \pm 5°C		
	Pitch = 10 mm	Pitch \geq 15 mm	
	0.8%	0.3% (Typical: 0.2%)	
Test Voltage Between Terminals	The 100% screening factory test is carried out at 2,700 VDC/1,700 VAC. The voltage level is selected to meet the requirements in applicable equipment standards. All electrical characteristics are checked after the test. It is not permitted to repeat this test as there is a risk to damage the capacitor. KEMET is not liable in such case for any failures.		
Insulation Resistance	Measured at +25°C \pm 5°C, according to IEC 60384-2		
	Minimum Values Between Terminals		
	Voltage Charge	Voltage Charge Time	C \leq 0.33 μ F
100 VDC	1 minute	\geq 1 \cdot 10 ⁵ M Ω	\geq 30,000 M Ω \cdot μ F

Performance Characteristics cont.

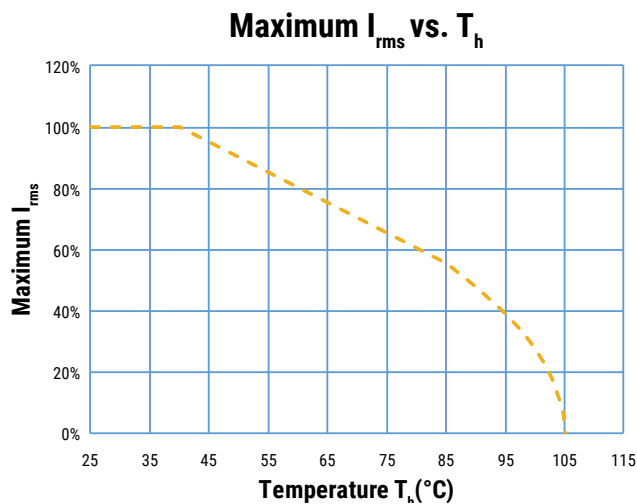
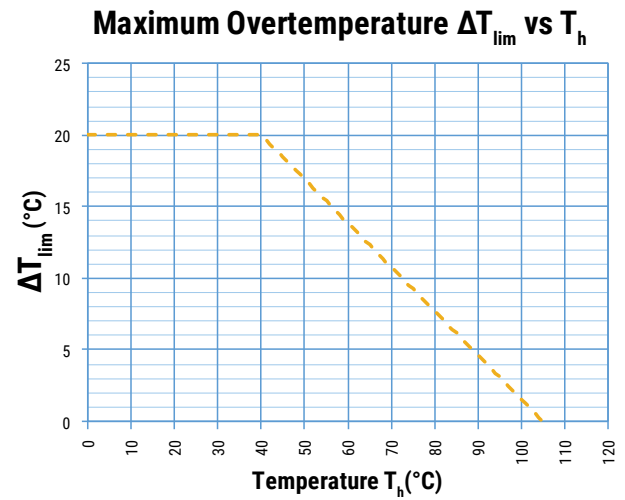
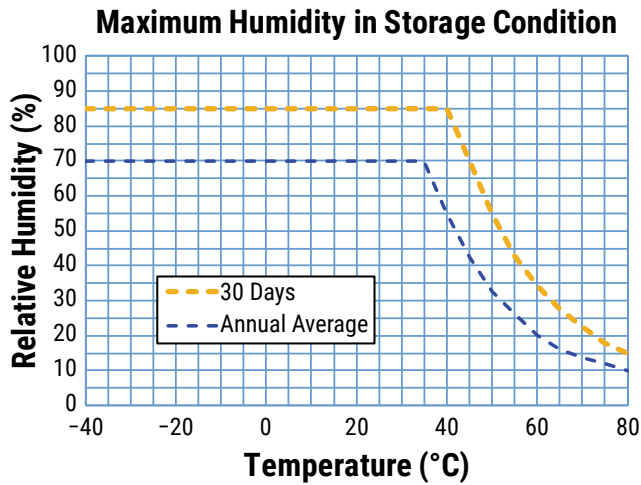

Qualification

Automotive grade products meet or exceed the requirements outlined by the Automotive Electronics Council. Details regarding test methods and conditions are referenced in document AEC-Q200, Stress Test Qualification for Passive Components. For additional information regarding the Automotive Electronics Council and AEC-Q200, please visit their website at www.aecouncil.com.

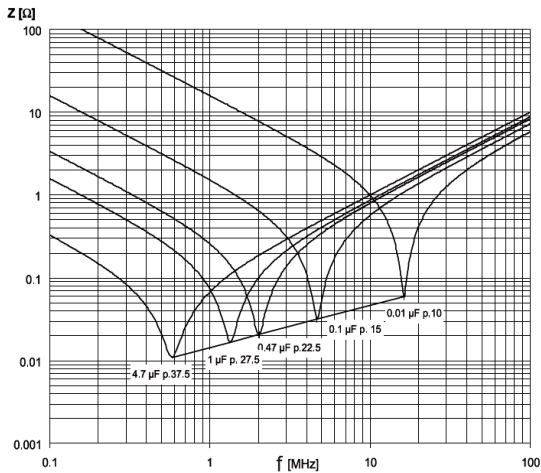

Impedance Graph



Environmental Test Data

Test	IEC Publication	Procedure
Endurance	EN/IEC 60384-14	1.25 x V _R VAC 50 Hz, once every hour increase to 1,000 VAC for 0.1 second, 1,000 hours at upper rated temperature
Vibration	IEC 60068-2-6 Test Fc	3 directions at 2 hours each 10 - 55 Hz at 0.75 mm or 98 m/s ²
Bump	IEC 60068-2-29 Test Eb	1,000 bumps at 390 m/s ²
Change of Temperature	IEC 60068-2-14 Test Na	Upper and lower rated temperature 5 cycles
Active Flammability	IEC 60384-14	V _R +20 surge pulses at 4 kV (pulse every 5 seconds)
Passive Flammability	IEC 60384-14	IEC 60384-1, IEC 60695-11-5 Needle flame test
Damp Heat Steady State	IEC 60068-2-78 Test Cab	+40°C and 93% RH, 56 days
Biased Humidity	MIL-STD-202 Method 103	1,000 hours 40°C/93%RH. Rated Voltage. Measurement at 24 ±2 hours after test conclusion.
THB Test		85°C, 85% RH and 440 VAC, 168 hours Capacitance change ($\Delta C/C$): $\leq 10\%$ Dissipation factor change ($\Delta \tan\delta$): $\leq 150 * 10^{-4}$ (at 1 kHz for Cap > 1 μ F) Dissipation factor change ($\Delta \tan\delta$): $\leq 240 * 10^{-4}$ (at 10 kHz for Cap ≤ 1 μ F) IR $\geq 50\%$ of initial limit or minimum 200 M Ω

Approvals

Certification Body	Mark	Specification	File Number
IMQ S.p.A.		EN/IEC 60384-14	CA08.00101
UL		UL 60384-14 and CAN/CSA E60384-14 (440 VAC)	E97797

Environmental Compliance

All KEMET EMI capacitors are RoHS Compliant.



Table 1 – Ratings & Part Number Reference

Capacitance Value (µF)	Dimensions in mm			Lead Spacing (S)	dV/dt (V/µs)	KEMET Part Number	Customer Part Number
	T	H	L				
0.0047	4.0	9.0	13.0	10.0	750	474F1470(1)A1(2) V057	R474F1470(1)A1(2) V057
0.0068	5.0	11.0	13.0	10.0	750	474F1680(1)A1(2) V057	R474F1680(1)A1(2) V057
0.0082	6.0	12.0	13.0	10.0	750	474F1820(1)A1(2) V057	R474F1820(1)A1(2) V057
0.010	6.0	12.0	13.0	10.0	750	474F2100(1)A1(2) V057	R474F2100(1)A1(2) V057
0.010	5.0	11.0	18.0	15.0	600	474I2100(1)A1(2) V057	R474I2100(1)A1(2) V057
0.012	5.0	11.0	18.0	15.0	600	474I2120(1)A1(2) V057	R474I2120(1)A1(2) V057
0.015	5.0	11.0	18.0	15.0	600	474I2150(1)A1(2) V057	R474I2150(1)A1(2) V057
0.018	5.0	11.0	18.0	15.0	600	474I2180(1)A1(2) V057	R474I2180(1)A1(2) V057
0.022	6.0	12.0	18.0	15.0	600	474I2220(1)A1(2) V057	R474I2220(1)A1(2) V057
0.027	6.0	12.0	18.0	15.0	600	474I2270(1)A1(2) V057	R474I2270(1)A1(2) V057
0.033	6.0	12.0	18.0	15.0	600	474I2330(1)A1(2) V057	R474I2330(1)A1(2) V057
0.039	7.5	13.5	18.0	15.0	600	474I2390(1)A1(2) V057	R474I2390(1)A1(2) V057
0.047	7.5	13.5	18.0	15.0	600	474I2470(1)A1(2) V057	R474I2470(1)A1(2) V057
0.047	6.0	17.5	18.0	15.0	600	474I2470(1)A2(2) V057	R474I2470(1)A2(2) V057
0.047	9.0	12.5	18.0	15.0	600	474I2470(1)A3(2) V057	R474I2470(1)A3(2) V057
0.056	8.5	14.5	18.0	15.0	600	474I2560(1)A1(2) V057	R474I2560(1)A1(2) V057
0.068	10.0	16.0	18.0	15.0	600	474I2680(1)A1(2) V057	R474I2680(1)A1(2) V057
0.068	7.5	18.5	18.0	15.0	600	474I2680(1)A2(2) V057	R474I2680(1)A2(2) V057
0.068	13.0	12.0	18.0	15.0	600	474I2680(1)A3(2) V057	R474I2680(1)A3(2) V057
0.082	10.0	16.0	18.0	15.0	600	474I2820(1)A1(2) V057	R474I2820(1)A1(2) V057
0.10	11.0	19.0	18.0	15.0	600	474I3100(1)A1(2) V057	R474I3100(1)A1(2) V057
0.047	6.0	15.0	26.5	22.5	300	474N2470(1)A1(2) V057	R474N2470(1)A1(2) V057
0.068	6.0	15.0	26.5	22.5	300	474N2680(1)A1(2) V057	R474N2680(1)A1(2) V057
0.10	7.0	16.0	26.5	22.5	300	474N3100(1)A1(2) V057	R474N3100(1)A1(2) V057
0.12	8.5	17.0	26.5	22.5	300	474N3120(1)A1(2) V057	R474N3120(1)A1(2) V057
0.15	10.0	18.5	26.5	22.5	300	474N3150(1)A1(2) V057	R474N3150(1)A1(2) V057
0.18	10.0	18.5	26.5	22.5	300	474N3180(1)A1(2) V057	R474N3180(1)A1(2) V057
0.22	11.0	20.0	26.5	22.5	300	474N3220(1)A1(2) V057	R474N3220(1)A1(2) V057
0.27	13.0	22.0	26.5	22.5	300	474N3270(1)A1(2) V057	R474N3270(1)A1(2) V057
0.33	13.0	22.0	26.5	22.5	300	474N3330(1)A1(2) V057	R474N3330(1)A1(2) V057
0.15	9.0	17.0	32.0	27.5	225	474R3150(1)A1(2) V057	R474R3150(1)A1(2) V057
0.18	9.0	17.0	32.0	27.5	225	474R3180(1)A1(2) V057	R474R3180(1)A1(2) V057
0.22	9.0	17.0	32.0	27.5	225	474R3220(1)A1(2) V057	R474R3220(1)A1(2) V057
0.27	9.0	17.0	32.0	27.5	225	474R3270(1)A2(2) V057	R474R3270(1)A2(2) V057
0.33	11.0	20.0	32.0	27.5	225	474R3330(1)A2(2) V057	R474R3330(1)A2(2) V057
0.39	11.0	20.0	32.0	27.5	225	474R3390(1)A1(2) V057	R474R3390(1)A1(2) V057
0.47	13.0	22.0	32.0	27.5	225	474R3470(1)A1(2) V057	R474R3470(1)A1(2) V057
0.56	13.0	22.0	32.0	27.5	225	474R3560(1)A1(2) V057	R474R3560(1)A1(2) V057
0.68	14.0	28.0	32.0	27.5	225	474R3680(1)A1(2) V057	R474R3680(1)A1(2) V057
0.82	18.0	33.0	32.0	27.5	225	474R3820(1)A1(2) V057	R474R3820(1)A1(2) V057
1.0	18.0	33.0	32.0	27.5	225	474R4100(1)A1(2) V057	R474R4100(1)A1(2) V057
1.2	18.0	33.0	32.0	27.5	225	474R4120(1)A1(2) V057	R474R4120(1)A1(2) V057
1.5	22.0	37.0	32.0	27.5	225	474R4150(1)A1(2) V057	R474R4150(1)A1(2) V057
0.47	11.0	22.0	41.5	37.5	150	474W3470(1)A1(2) V057	R474W3470(1)A1(2) V057
0.56	11.0	22.0	41.5	37.5	150	474W3560(1)A1(2) V057	R474W3560(1)A1(2) V057
0.68	13.0	24.0	41.5	37.5	150	474W3680(1)A1(2) V057	R474W3680(1)A1(2) V057
0.82	16.0	28.5	41.5	37.5	150	474W3820(1)A1(2) V057	R474W3820(1)A1(2) V057
1.0	16.0	28.5	41.5	37.5	150	474W4100(1)A1(2) V057	R474W4100(1)A1(2) V057
1.2	19.0	32.0	41.5	37.5	150	474W4120(1)A1(2) V057	R474W4120(1)A1(2) V057
1.5	19.0	32.0	41.5	37.5	150	474W4150(1)A1(2) V057	R474W4150(1)A1(2) V057
1.8	20.0	40.0	41.5	37.5	150	474W4180(1)A1(2) V057	R474W4180(1)A1(2) V057
2.2	20.0	40.0	41.5	37.5	150	474W4220(1)A1(2) V057	R474W4220(1)A1(2) V057
Capacitance Value (µF)	T (mm)	H (mm)	L (mm)	Lead Spacing (S)	dV/dt (V/µs)	KEMET Part Number	Customer Part Number

(1) Insert lead and packaging code. See Ordering Options Table for available options.

(2) M = ±20%, K = ±10%

Soldering Process

The implementation of the RoHS directive has resulted in the selection of SnAgCu (SAC) alloys or SnCu alloys as primary solder. This has increased the liquidus temperature from that of 183°C for SnPb eutectic alloy to 217 – 221°C for the new alloys. As a result, the heat stress to the components, even in wave soldering, has increased considerably due to higher pre-heat and wave temperatures. Polypropylene capacitors are especially sensitive to heat (the melting point of polypropylene is 160 – 170°C). Wave soldering can be destructive, especially for mechanically small polypropylene capacitors (with lead spacing of 5 mm to 15 mm), and great care has to be taken during soldering. The recommended solder profiles from KEMET should be used. Please consult KEMET with any questions. In general, the wave soldering curve from IEC Publication 61760-1 Edition 2 serves as a solid guideline for successful soldering. Please see Figure 1.

Reflow soldering is not recommended for through-hole film capacitors. Exposing capacitors to a soldering profile in excess of the above the recommended limits may result to degradation or permanent damage to the capacitors.

Do not place the polypropylene capacitor through an adhesive curing oven to cure resin for surface mount components. Insert through-hole parts after the curing of surface mount parts. Consult KEMET to discuss the actual temperature profile in the oven, if through-hole components must pass through the adhesive curing process. A maximum two soldering cycles is recommended. Please allow time for the capacitor surface temperature to return to a normal temperature before the second soldering cycle.

Manual Soldering Recommendations

The following is the recommendation for manual soldering with a soldering iron.

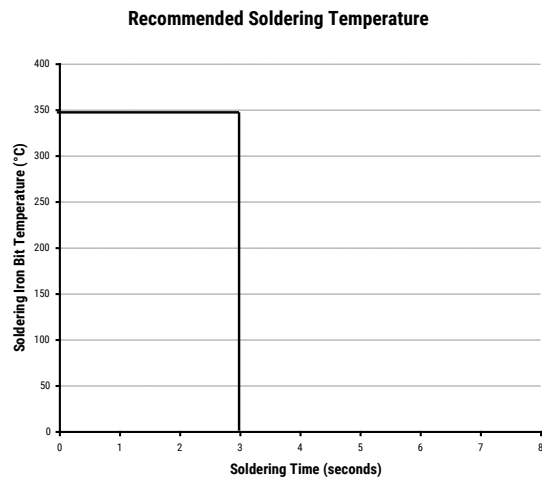

The soldering iron tip temperature should be set at 350°C (+10°C maximum) with the soldering duration not to exceed more than 3 seconds.

Wave Soldering Recommendations

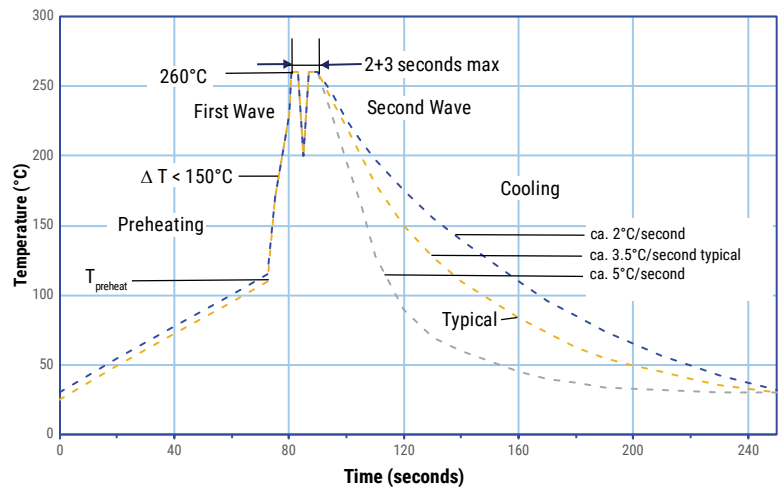

Soldering Process cont.

Wave Soldering Recommendations cont.

1. The table indicates the maximum set-up temperature of the soldering process
Figure 1

Dielectric Film Material	Maximum Preheat Temperature		Maximum Peak Soldering Temperature	
	Capacitor Pitch ≤ 15 mm	Capacitor Pitch > 15 mm	Capacitor Pitch ≤ 15 mm	Capacitor Pitch > 15 mm
Polyester	130°C	130°C	270°C	270°C
Polypropylene	110°C	130°C	260°C	270°C
Paper	130°C	140°C	270°C	270°C
Polyphenylene Sulphide	150°C	160°C	270°C	270°C

2. The maximum temperature measured inside the capacitor:

Set the temperature so that inside the element the maximum temperature is below the limit:

Dielectric Film Material	Maximum temperature measured inside the element
Polyester	160°C
Polypropylene	110°C
Paper	160°C
Polyphenylene sulphide	160°C

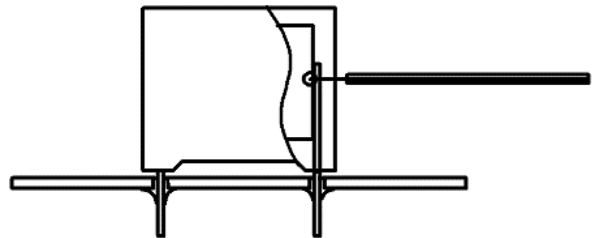

Temperature monitored inside the capacitor.

Selective Soldering Recommendations

Selective dip soldering is a variation of reflow soldering. In this method, the printed circuit board with through-hole components to be soldered is preheated and transported over the solder bath as in normal flow soldering without touching the solder. When the board is over the bath, it is stopped and pre-designed solder pots are lifted from the bath with molten solder only at the places of the selected components, and pressed against the lower surface of the board to solder the components.

The temperature profile for selective soldering is similar to the double wave flow soldering outlined in this document, **however, instead of two baths, there is only one bath with a time from 3 to 10 seconds.** In selective soldering, the risk of overheating is greater than in double wave flow soldering, and great care must be taken so that the parts are not overheated.

Mounting

Resistance to Vibration and Mechanical Shock

AEC-Q200 Mechanical Stress Tests:

Mechanical Shock	MIL-STD-202 Method 213	Test condition C Peak value 100 g, duration 6 ms, half-sine-wave (see MIL-HDBK for details)
Vibration	MIL-STD-202 Method 204	5 g for 20 minutes, 12 cycles each of 3 orientations Use 8"X5" PCB, 0.031" thick. 7 secure points on one 8" side and 2 secure points at corners of opposite sides. Parts mounted within 2" from any secure point. Test from 10 – 2,000 Hz.

The capacitors are designed for PCB mounting. The stand-off pipes must be in good contact with the printed circuit board. The capacitors with pitch ≤ 22.5 mm can be mechanically fixed by the leads, for pitch > 22.5 mm, the capacitor body has to be properly fixed (e.g. clamped or glued).

Construction

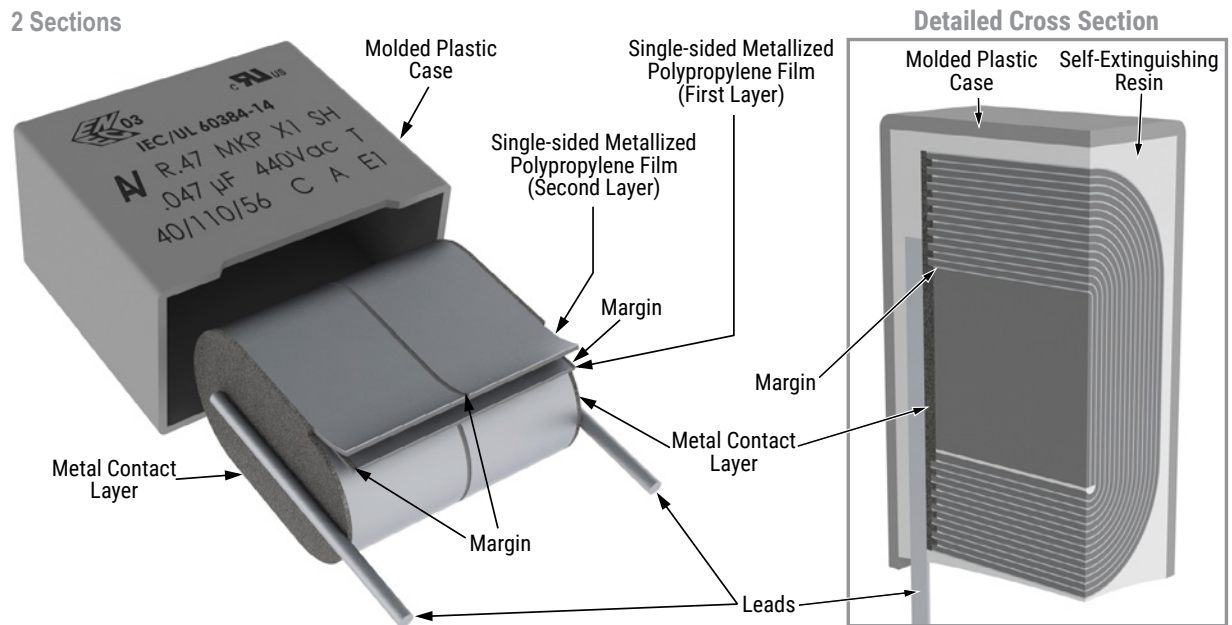

Winding Scheme

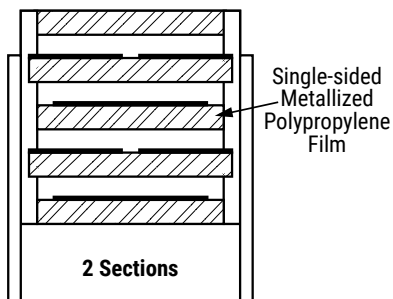

Marking

Lead Spacing 10 mm

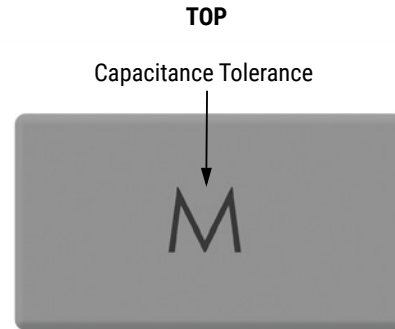
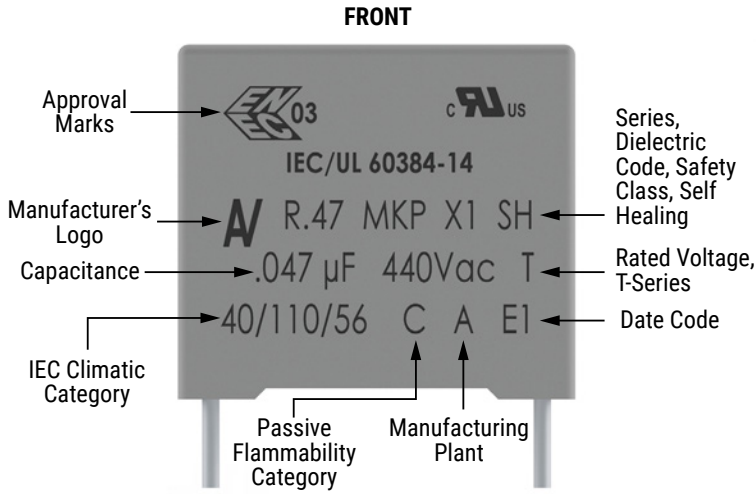

NOTE: Hot imprinting with or without color or ink jet or laser marking

Lead Spacing 15 mm, 22.5 mm (small case sizes)

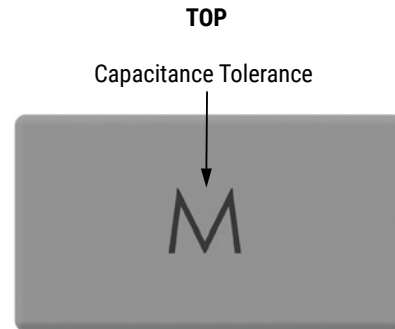
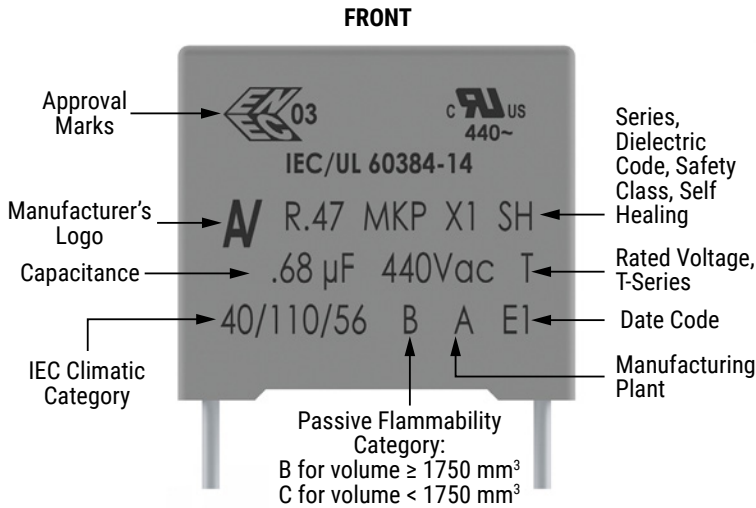

NOTE: Hot imprinting with or without color or ink jet or laser marking

* Differences caused by technology (clichee, laser or ink jet) and production line

Marking cont.

Lead Spacing 22.5 and 27.5 mm (alternatives*) and 37.5 mm

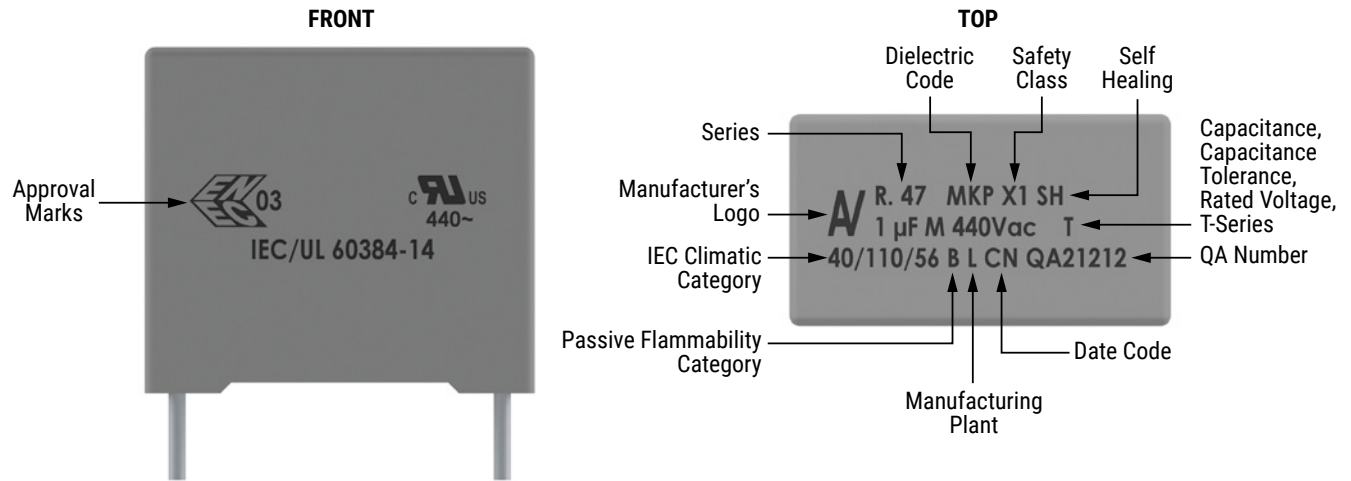

* Differences caused by technology (clichee, laser or ink jet) and production line

Manufacturing Date Code (IEC 60062)			
Year	Code	Month	Code
2010	A	January	1
2011	B	February	2
2012	C	March	3
2013	D	April	4
2014	E	May	5
2015	F	June	6
2016	H	July	7
2017	J	August	8
2018	K	September	9
2019	L	October	0
2020	M	November	N
2021	N	December	D
2022	P		
2023	R		
2024	S		
2025	T		
2026	U		
2027	V		
2028	W		
2029	X		
2030	A		

Packaging Quantities

Lead Spacing (mm)	Thickness (mm)	Height (mm)	Length (mm)	Bulk Short Leads	Bulk Long Leads	Standard Reel ø 355 mm	Large Reel ø 500 mm	Ammo Taped
10	4.0	9.0	13.0	2,000	1,800	750	1,500	1,000
	5.0	11.0	13.0	1,300	1,500	600	1,250	800
	6.0	12.0	13.0	1,000	1,200	500	1,000	680
15	5.0	11.0	18.0	2,000	1,000	600	1,250	800
	6.0	12.0	18.0	1,750	900	500	1,000	680
	6.0	17.5	18.0	1,000	700	500	1,000	680
	7.5	13.5	18.0	1,000	700	350	800	500
	7.5	18.5	18.0	900	500	-	800	500
	8.5	14.5	18.0	1,000	500	300	700	440
	9.0	12.5	18.0	1,000	520	270	650	410
	10.0	16.0	18.0	750	500	300	600	380
	11.0	19.0	18.0	450	350	-	500	340
13.0	12.0	18.0	750	490	200	480	280	
22.5	6.0	15.0	26.5	805	500	-	700	464
	6.5	13.5	26.5	800	-	-	-	-
	7.0	16.0	26.5	700	500	-	550	380
	8.5	17.0	26.5	468	300	-	450	280
	10.0	18.5	26.5	396	300	-	350	235
	11.0	20.0	26.5	360	250	-	350	217
	13.0	22.0	26.5	300	200	-	300	-
27.5	9.0	17.0	32.0	816	408	-	450	-
	11.0	20.0	32.0	560	336	-	350	-
	13.0	22.0	32.0	480	288	-	300	-
	14.0	28.0	32.0	352	176	-	-	-
	18.0	33.0	32.0	256	128	-	-	-
	22.0	37.0	32.0	168	112	-	-	-
	22.0	37.0	32.0	168	112	-	-	-
37.5	11.0	22.0	41.5	420	252	-	-	-
	13.0	24.0	41.5	360	216	-	-	-
	16.0	28.5	41.5	216	108	-	-	-
	19.0	32.0	41.5	192	96	-	-	-
	20.0	40.0	41.5	126	84	-	-	-

Lead Taping & Packaging (IEC 60286-2)

Figure 1
Lead Spacing 10 mm

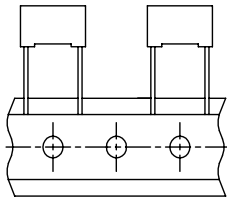

Figure 2
Lead Spacing 15 mm

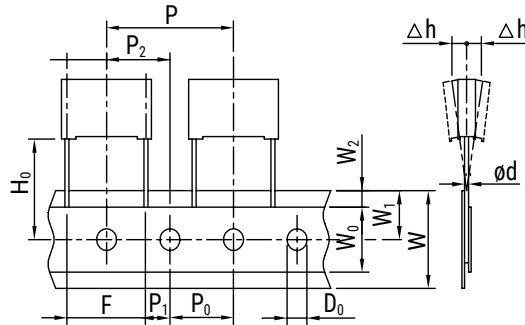
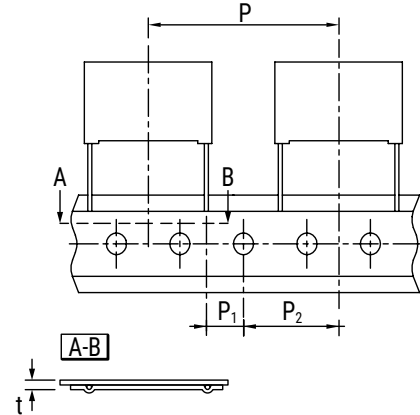

Figure 3
Lead Spacing 22.5 – 27.5 mm



Taping Specification

Description	Symbol	Dimensions (mm)					Tol.
		Lead Space					
		10 Fig. 1	15 Fig. 2	22.5 Fig. 3	27.5 Fig. 3		
Lead wire diameter	d	0.6	0.6-0.8	0.8	0.8	±0.05	
Taping lead space	P	25.4	25.4	38.1	38.1	±1	
Feed hole lead space *	P ₀	12.7	12.7	12.7	12.7	±0.2 **	
Centering of the lead wire	P ₁	7.7	5.2	7.8	5.3	±0.7	
Centering of the body	P ₂	12.7	12.7	19.05	19.05	±1.3	
Lead spacing (pitch) ***	F	10	15	22.5	27.5	+0.6/-0.1	
Component alignment	Δh	0	0	0	0	±2	
Height of component from tape center	H ₀ ****	18.5	18.5	18.5	18.5	±0.5	
Carrier tape width	W	18	18	18	18	+1/-0.5	
Hold down tape width	W ₀	9	10	10	10	Minimum	
Hole position	W ₁	9	9	9	9	±0.5	
Hold down tape position	W ₂	3	3	3	3	Maximum	
Feed hole diameter	D ₀	4	4	4	4	±0.2	
Total tape thickness	t	0.7	0.7	0.7	0.7	±0.2	

* 15 mm also available

** Maximum of 1 mm on 20 lead spaces

*** Pitches 15 mm and 10 mm taped to 7.5 mm (crimped leads) available upon request

**** H₀ = 16.5 mm is available upon request

Lead Taping & Packaging (IEC 60286-2) cont.

Ammo Specifications

Dimensions (mm)		
H	W	T
360	340	59

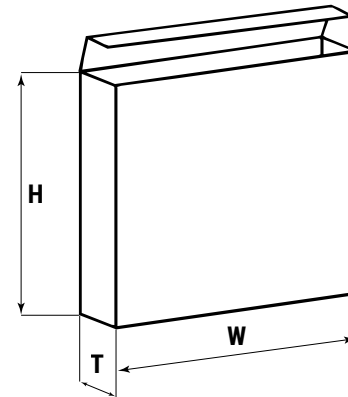

Reel Specifications

Reel Size	Dimensions (mm)		
	D	H	W
Standard	355	30	55 Maximum
Large	500	25	

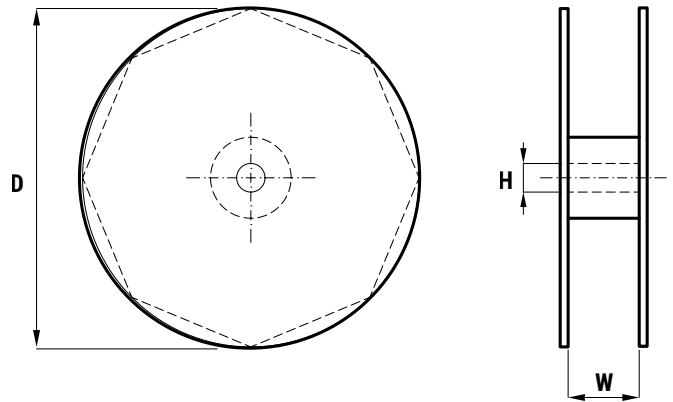

KEMET Electronics Corporation Sales Offices

For a complete list of our global sales offices, please visit www.kemet.com/sales.

Disclaimer

All product specifications, statements, information and data (collectively, the "Information") in this datasheet are subject to change. The customer is responsible for checking and verifying the extent to which the Information contained in this publication is applicable to an order at the time the order is placed. All Information given herein is believed to be accurate and reliable, but it is presented without guarantee, warranty, or responsibility of any kind, expressed or implied.

Statements of suitability for certain applications are based on KEMET Electronics Corporation's ("KEMET") knowledge of typical operating conditions for such applications, but are not intended to constitute – and KEMET specifically disclaims – any warranty concerning suitability for a specific customer application or use. The Information is intended for use only by customers who have the requisite experience and capability to determine the correct products for their application. Any technical advice inferred from this Information or otherwise provided by KEMET with reference to the use of KEMET's products is given gratis, and KEMET assumes no obligation or liability for the advice given or results obtained.

Although KEMET designs and manufactures its products to the most stringent quality and safety standards, given the current state of the art, isolated component failures may still occur. Accordingly, customer applications which require a high degree of reliability or safety should employ suitable designs or other safeguards (such as installation of protective circuitry or redundancies) in order to ensure that the failure of an electrical component does not result in a risk of personal injury or property damage.

Although all product-related warnings, cautions and notes must be observed, the customer should not assume that all safety measures are indicated or that other measures may not be required.

KEMET is a registered trademark of KEMET Electronics Corporation.