

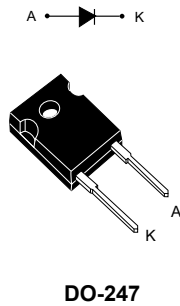

Automotive 800 V, 60 A bridge rectifier diode



Features

- AEC-Q101 qualified 
- Ultra low conduction losses
- Ultra-low reverse losses
- High junction temperature capability (+175 °C)
- V_{RRM} guaranteed from -40 to +175 °C
- PPAP capable
- ECOPACK2 compliant

Applications

- On board charger (OBC)
- Charging stations
- Bridge function

Description

The high quality design of this diode has produced a device with consistently reproducible characteristics and intrinsic ruggedness. These characteristics make it ideal for heavy duty applications that demand long term reliability like automotive applications.

Thanks to its ultra-low conduction losses, the STBR6008-Y is especially suitable for use as input bridge diode in battery chargers and charging stations.

Product status link

[STBR6008-Y](#)

Product summary

Symbol	Value
$I_{F(AV)}$	60 A
V_{RRM}	800 V
T_j	-40 to +175 °C
V_F (typ.)	1.00 V

1 Characteristics

Table 1. Absolute ratings (limiting values at 25 °C, unless otherwise specified)

Symbol	Parameter		Value	Unit
V_{RRM}	Repetitive peak reverse voltage	$T_j = -40\text{ °C to }+175\text{ °C}$	800	V
V_{RSM}	Non-repetitive surge reverse voltage	$t_p = 10\text{ ms square}$	900	V
$I_{F(RMS)}$	Forward rms current		90	A
$I_{F(AV)}$	Average forward current	$T_C = 160\text{ °C}, \delta = 0.5\text{ square wave}$	60	A
I_{FSM}	Surge non repetitive forward current	$t_p = 10\text{ ms sinusoidal}$	500	A
T_{stg}	Storage temperature range		-65 to +175	°C
T_j	Operating junction temperature		-40 to +175	°C

Table 2. Thermal parameters

Symbol	Parameter	Typ. value	Unit
$R_{th(j-c)}$	Junction to case	0.20	°C/W

For more information, please refer to the following application note :

- AN5088 : Rectifiers thermal management, handling and mounting recommendations

Table 3. Static electrical characteristics

Symbol	Parameter	Test conditions		Min.	Typ.	Max.	Unit
I_R	Reverse leakage current	$T_j = 25\text{ °C}$	$V_R = V_{RRM}$	-		5	μA
		$T_j = 150\text{ °C}$		-	25	250	
V_F	Forward voltage drop	$T_j = 25\text{ °C}$	$I_F = 60\text{ A}$	-	1.00	1.10	V
		$T_j = 150\text{ °C}$		-	0.88	0.97	

1. Pulse test: $t_p = 5\text{ ms}, \delta < 2\%$

2. Pulse test: $t_p = 380\text{ }\mu\text{s}, \delta < 2\%$

To evaluate the conduction losses, use the following equation:

$$P = 0.75 \times I_{F(AV)} + 0.0036 \times I_{F(RMS)}^2$$

For more information, please refer to the following application notes related to the power losses:

- AN604: Calculation of conduction losses in a power rectifier
- AN4021: Calculation of reverse losses in a power diode

1.1 Characteristics (curves)

Figure 1. Average forward power dissipation versus average forward current

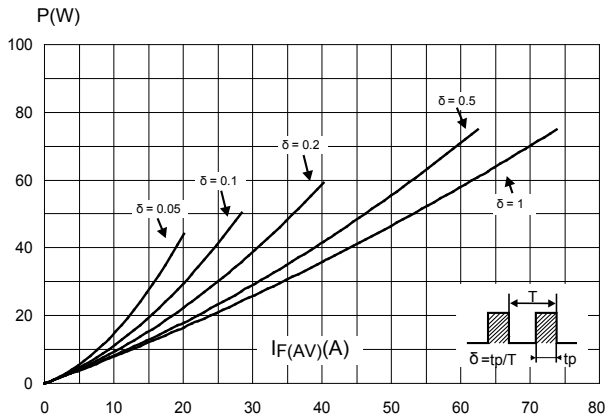

Figure 2. Forward voltage drop versus forward current (typical values)

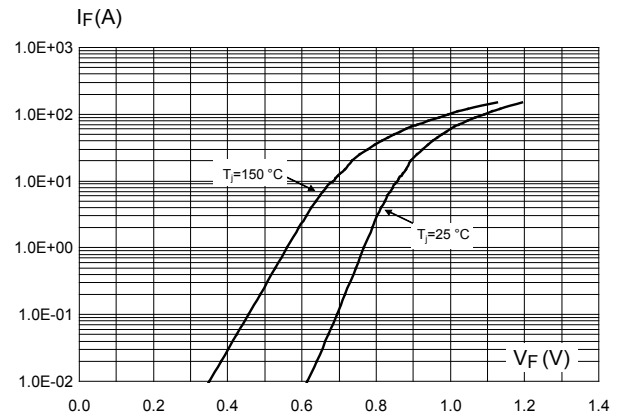

Figure 3. Forward voltage drop versus forward current (maximum values)

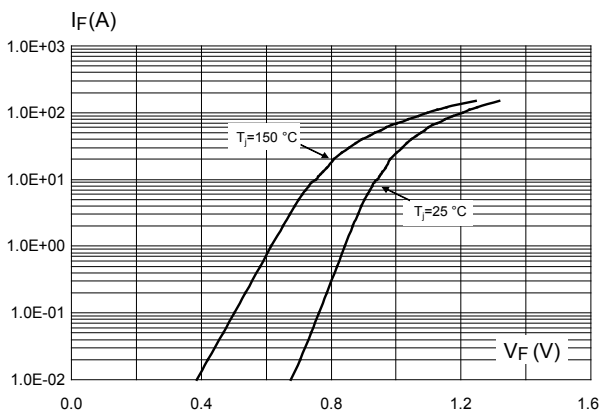

Figure 4. Relative variation of thermal impedance junction to case versus pulse duration

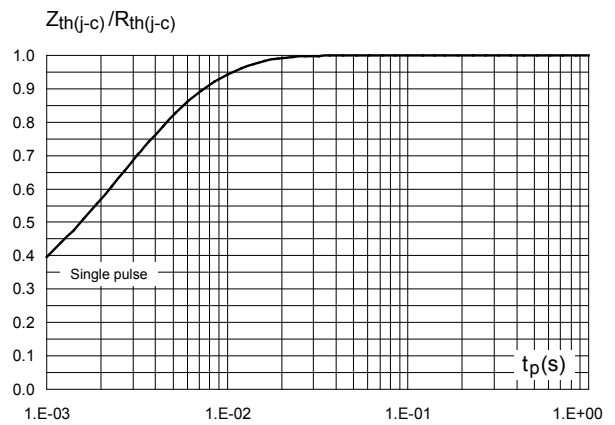

Figure 5. Junction capacitance versus reverse voltage applied (typical values)

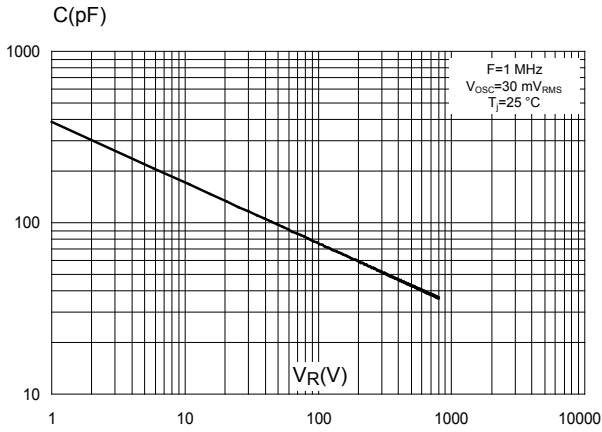

Figure 6. Relative variation of non-repetitive peak surge forward current versus pulse duration (sinusoidal waveform)

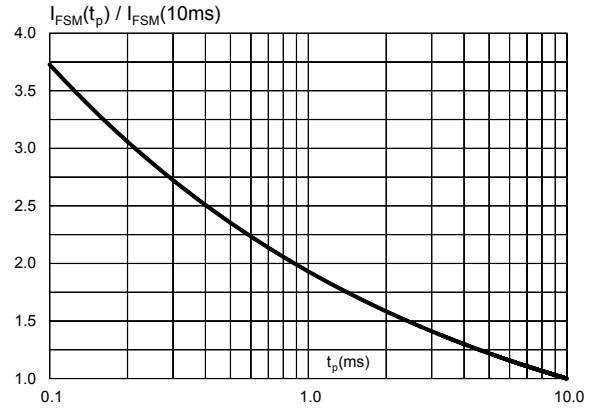

Figure 7. Relative variation of non-repetitive peak surge forward current versus initial junction temperature (sinusoidal waveform)

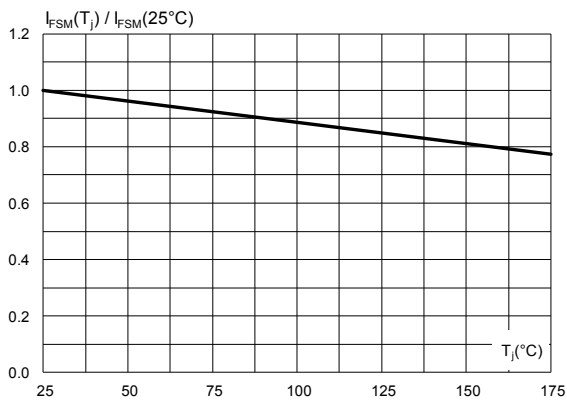
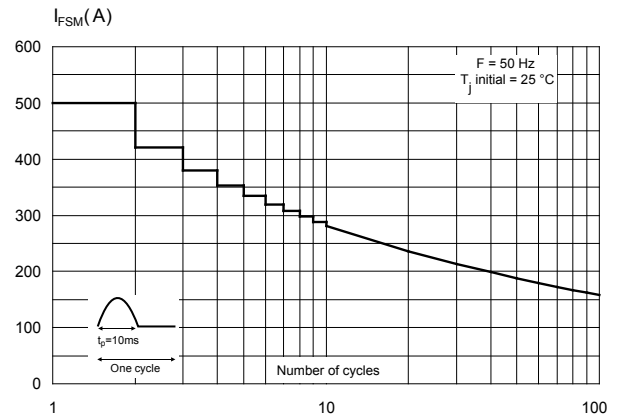

Figure 8. Non repetitive surge peak forward current versus number of cycles



2 Package information

In order to meet environmental requirements, ST offers these devices in different grades of **ECOPACK** packages, depending on their level of environmental compliance. ECOPACK specifications, grade definitions and product status are available at: www.st.com. ECOPACK is an ST trademark.

2.1 DO-247 package information

- Epoxy meets UL94, V0
- Cooling method: by conduction (C)
- Recommended torque value: 0.8 N·m (DO-247)
- Maximum torque value: 1.0 N·m (DO-247)

Figure 9. DO-247 package outline

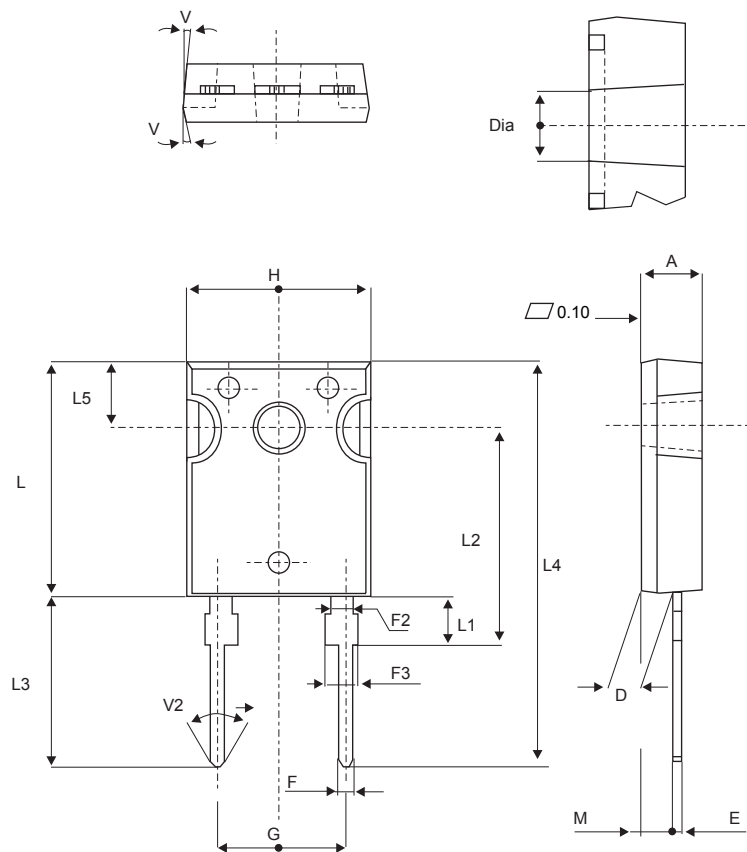

Table 4. DO-247 package mechanical data

Ref.	Dimensions			
	Millimeters		Inches	
	Min.	Max.	Min.	Max.
A	4.85	5.15	0.191	0.203
D	2.20	2.60	0.086	0.102
E	0.40	0.80	0.015	0.031
F	1.00	1.40	0.039	0.055
F2	2.00 typ.		0.078 typ.	
F3	2.00	2.40	0.078	0.094
G	10.90 typ.		0.429 typ.	
H	15.45	15.75	0.608	0.620
L	19.85	20.15	0.781	0.793
L1	3.70	4.30	0.145	0.169
L2	18.50 typ.		0.728 typ.	
L3	14.20	14.80	0.559	0.582
L4	34.60 typ.		1.362 typ.	
L5	5.50 typ.		0.216 typ.	
M	2.00	3.00	0.078	0.118
V	5°		5°	
V2	60°		60°	
Dia.	3.55	3.65	0.139	0.143

3 Ordering information

Table 5. Ordering information

Order code	Marking	Package	Weight	Base qty.	Delivery mode
STBR6008WY	STBR6008WY	DO-247	4.4 g	30	Tube

Revision history

Table 6. Document revision history

Date	Revision	Changes
10-Jun-2019	1	First issue.

IMPORTANT NOTICE – PLEASE READ CAREFULLY

STMicroelectronics NV and its subsidiaries (“ST”) reserve the right to make changes, corrections, enhancements, modifications, and improvements to ST products and/or to this document at any time without notice. Purchasers should obtain the latest relevant information on ST products before placing orders. ST products are sold pursuant to ST’s terms and conditions of sale in place at the time of order acknowledgement.

Purchasers are solely responsible for the choice, selection, and use of ST products and ST assumes no liability for application assistance or the design of Purchasers’ products.

No license, express or implied, to any intellectual property right is granted by ST herein.

Resale of ST products with provisions different from the information set forth herein shall void any warranty granted by ST for such product.

ST and the ST logo are trademarks of ST. For additional information about ST trademarks, please refer to www.st.com/trademarks. All other product or service names are the property of their respective owners.

Information in this document supersedes and replaces information previously supplied in any prior versions of this document.

© 2019 STMicroelectronics – All rights reserved