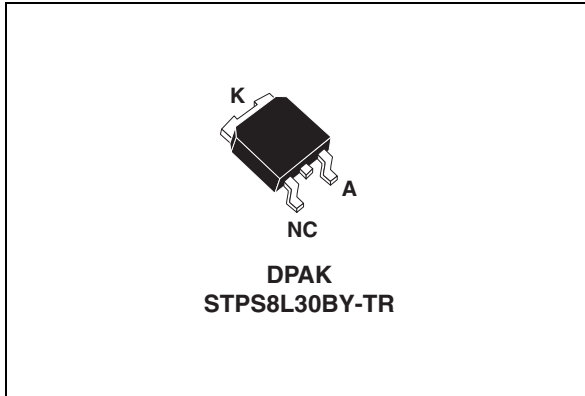

Automotive low drop power Schottky rectifier

Datasheet – production data

Table 1. Device summary

Symbol	Value
$I_{F(AV)}$	8 A
V_{RRM}	30 V
T_j	150 °C
$V_F (MAX)$	0.40 V

Features

- Low cost device with low drop forward voltage for less power dissipation and reduced heatsink.
- Optimized conduction/reverse losses trade-off which leads to the highest yield in the application.
- High power surface mount miniature package.
- AEC-Q101 qualified.

Description

Single Schottky rectifier is suited to switched mode power supplies and high frequency DC to DC converters.

Packaged in DPAK, this device is especially intended for use as a rectifier at the SMPS or DC/DC units polarity protection in automotive applications.

1 Characteristics

Table 2. Absolute ratings (limiting values)

Symbol	Parameter		Value	Unit
V_{RRM}	Repetitive peak reverse voltage		30	V
$I_{F(RMS)}$	Forward rms current		7	A
$I_{F(AV)}$	Average forward current, $\delta = 0.5$	$T_c = 135\text{ }^\circ\text{C}$	8	A
I_{FSM}	Surge non repetitive forward current	$t_p = 10\text{ ms}$ sinusoidal	75	A
I_{RRM}	Peak repetitive reverse current	$t_p = 2\text{ }\mu\text{s}$, $F = 1\text{ kHz}$ square	1	A
I_{RSM}	Non repetitive peak reverse current	$t_p = 100\text{ }\mu\text{s}$ square	2	A
T_{stg}	Storage temperature range		-65 to +150	$^\circ\text{C}$
T_j	Operating junction temperature ⁽¹⁾		-40 to +150	$^\circ\text{C}$
dV/dt	Critical rate of rise of reverse voltage		10000	V/ μs

1. $\frac{dP_{tot}}{dT_j} < \frac{1}{R_{th(j-a)}}$ condition to avoid thermal runaway for a diode on its own heatsink

Table 3. Thermal parameters

Symbol	Parameter	Value	Unit
$R_{th(j-c)}$	Junction to case	2.5	$^\circ\text{C/W}$

Table 4. Static electrical characteristics (per diode)

Symbol	Parameter	Test conditions		Min.	Typ	Max.	Unit
$I_R^{(1)}$	Reverse leakage current	$T_j = 25\text{ }^\circ\text{C}$	$V_R = V_{RRM}$	-	-	1	mA
		$T_j = 100\text{ }^\circ\text{C}$		-	15	40	
$V_F^{(2)}$	Forward voltage drop	$T_j = 25\text{ }^\circ\text{C}$	$I_F = 8\text{ A}$	-	-	0.49	V
		$T_j = 125\text{ }^\circ\text{C}$		-	0.35	0.40	
		$T_j = 25\text{ }^\circ\text{C}$	$I_F = 16\text{ A}$	-	-	0.63	
		$T_j = 125\text{ }^\circ\text{C}$		-	0.448	0.57	

1. Pulse test: $t_p = 5\text{ ms}$, $\delta < 2\%$
2. Pulse test: $t_p = 380\text{ }\mu\text{s}$, $\delta < 2\%$

To evaluate the conduction losses use the following equation:

$$P = 0.23 \times I_{F(AV)} + 0.021 \times I_{F(RMS)}^2$$

Figure 1. Average forward power dissipation vs. average forward current

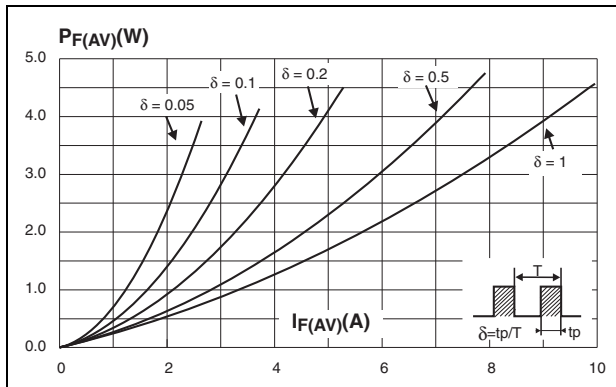

Figure 2. Average forward current versus ambient temperature ($\delta = 0.5$)

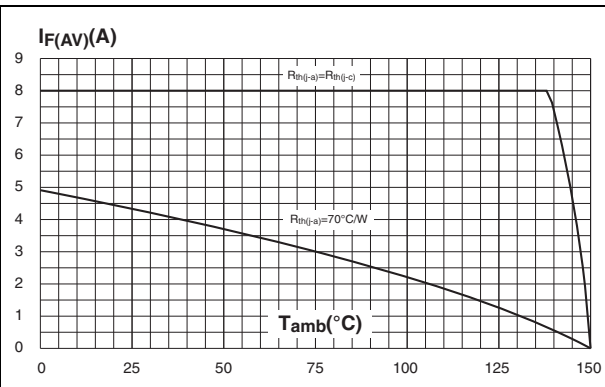

Figure 3. Non repetitive surge peak forward current versus overload duration (maximum values)

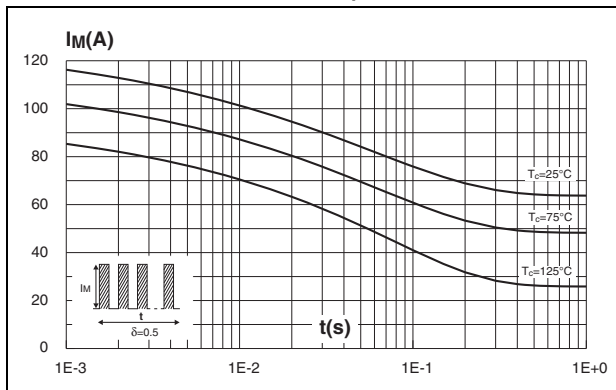

Figure 4. Relative variation of thermal impedance junction to ambient versus pulse duration

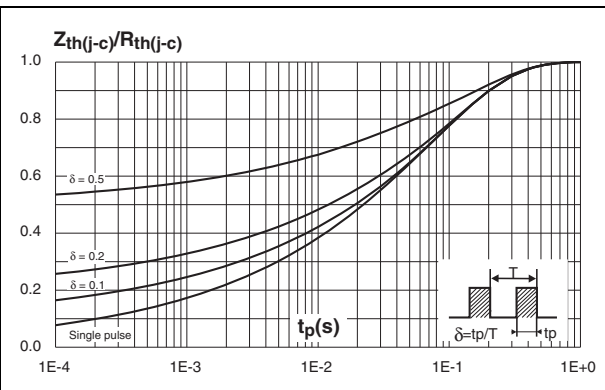

Figure 5. Reverse leakage current vs. reverse voltage applied (typical values)

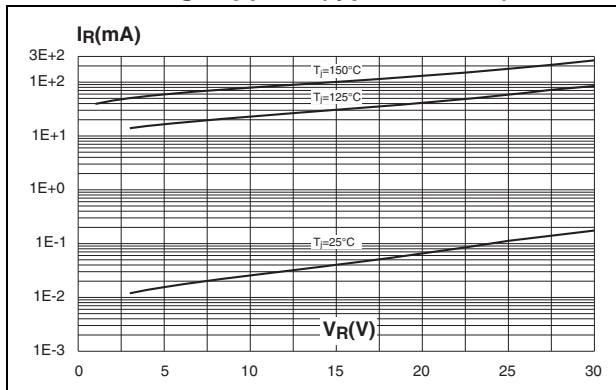

Figure 6. Junction capacitance vs. reverse voltage applied (typical values)

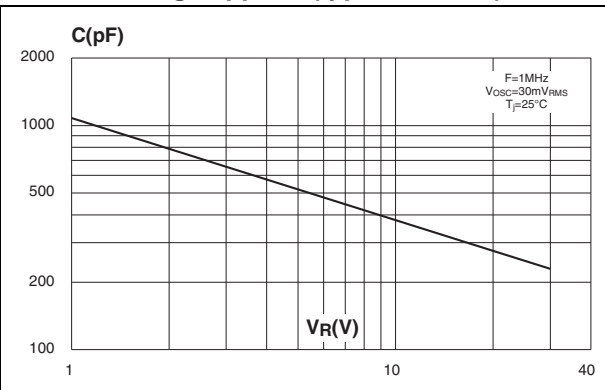

Figure 7. Forward voltage drop vs. forward current

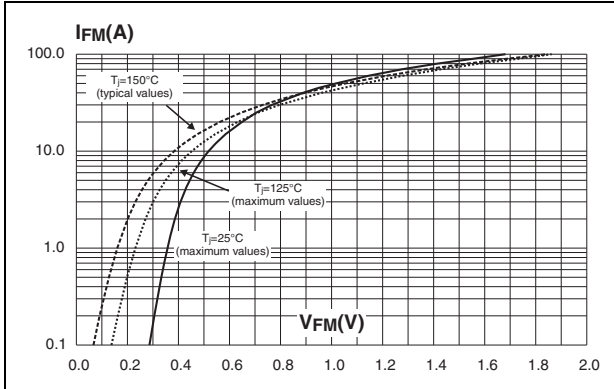
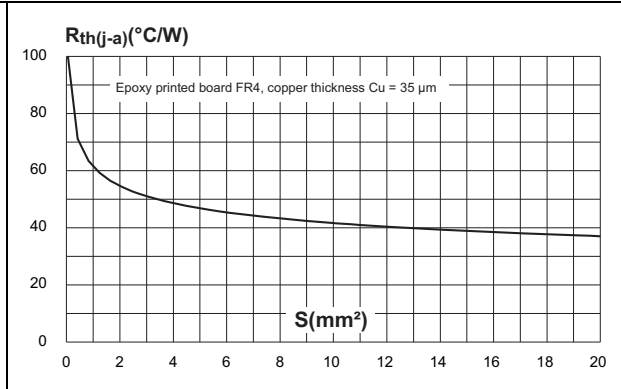

Figure 8. Thermal resistance junction to ambient versus copper surface under tab



2 Package information

- Epoxy meets UL94,V0
- Lead-free packages

In order to meet environmental requirements, ST offers these devices in different grades of ECOPACK[®] packages, depending on their level of environmental compliance. ECOPACK[®] specifications, grade definitions and product status are available at: www.st.com. ECOPACK[®] is an ST trademark.

Figure 9. DPAK dimension definitions

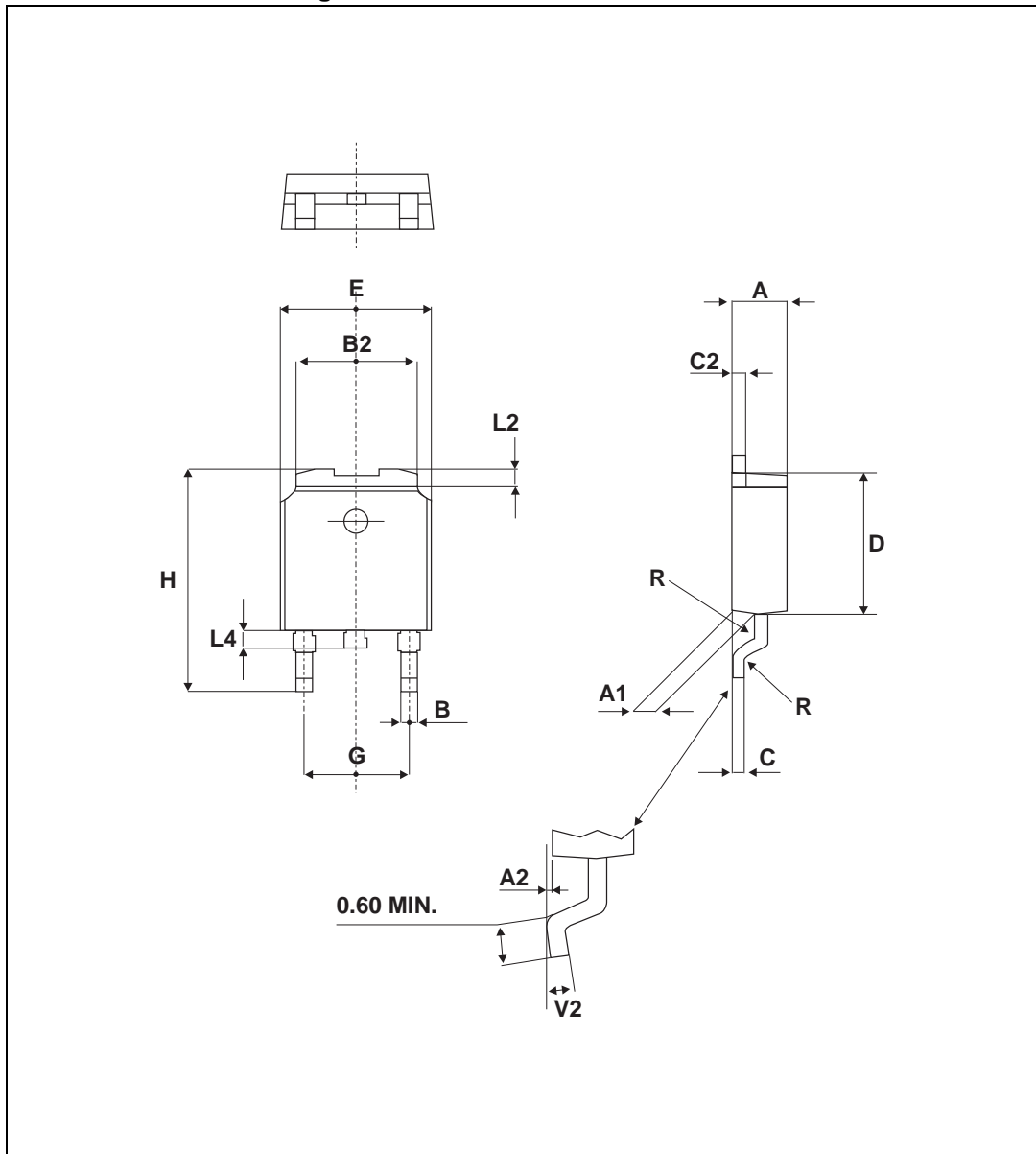
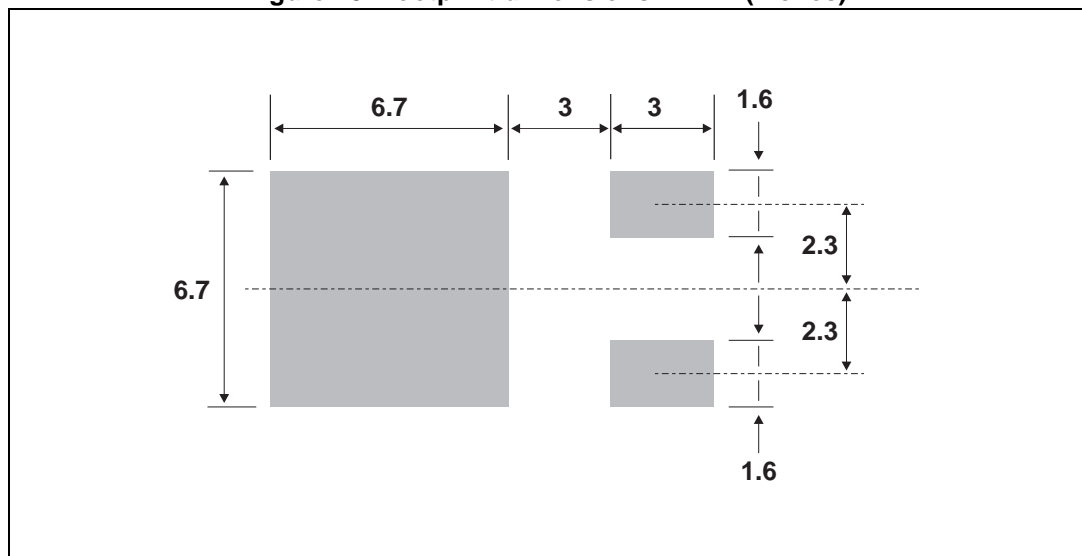

Table 5. DPAK dimension values

Ref.	Dimensions					
	Millimeters			Inches		
	Min.	Typ.	Max.	Min.	Typ.	Max.
A	2.20		2.40	0.086		0.094
A1	0.90		1.10	0.035		0.043
A2	0.03		0.23	0.001		0.009
B	0.64		0.90	0.025		0.035
B2	5.20		5.40	0.204		0.212
C	0.45		0.60	0.017		0.023
C2	0.48		0.60	0.018		0.023
D	6.00		6.20	0.236		0.244
E	6.40		6.60	0.251		0.259
G	4.40		4.60	0.173		0.181
H	9.35		10.10	0.368		0.397
L2		0.80 typ.			0.031 typ.	
L4	0.60		1.00	0.023		0.039
V2	0°		8°	0°		8°

Figure 10. Footprint dimensions in mm (inches)



3 Ordering information

Table 6. Ordering information

Order code	Marking	Package	Weight	Base qty	Delivery mode
STPS8L30BY-TR	LS30Y	DPAK	0.3 g	2500	Tape and reel

4 Revision history

Table 7. Revision history

Date	Revision	Changes
11-Jul-2013	1	First issue

Please Read Carefully:

Information in this document is provided solely in connection with ST products. STMicroelectronics NV and its subsidiaries ("ST") reserve the right to make changes, corrections, modifications or improvements, to this document, and the products and services described herein at any time, without notice.

All ST products are sold pursuant to ST's terms and conditions of sale.

Purchasers are solely responsible for the choice, selection and use of the ST products and services described herein, and ST assumes no liability whatsoever relating to the choice, selection or use of the ST products and services described herein.

No license, express or implied, by estoppel or otherwise, to any intellectual property rights is granted under this document. If any part of this document refers to any third party products or services it shall not be deemed a license grant by ST for the use of such third party products or services, or any intellectual property contained therein or considered as a warranty covering the use in any manner whatsoever of such third party products or services or any intellectual property contained therein.

UNLESS OTHERWISE SET FORTH IN ST'S TERMS AND CONDITIONS OF SALE ST DISCLAIMS ANY EXPRESS OR IMPLIED WARRANTY WITH RESPECT TO THE USE AND/OR SALE OF ST PRODUCTS INCLUDING WITHOUT LIMITATION IMPLIED WARRANTIES OF MERCHANTABILITY, FITNESS FOR A PARTICULAR PURPOSE (AND THEIR EQUIVALENTS UNDER THE LAWS OF ANY JURISDICTION), OR INFRINGEMENT OF ANY PATENT, COPYRIGHT OR OTHER INTELLECTUAL PROPERTY RIGHT.

ST PRODUCTS ARE NOT AUTHORIZED FOR USE IN WEAPONS. NOR ARE ST PRODUCTS DESIGNED OR AUTHORIZED FOR USE IN: (A) SAFETY CRITICAL APPLICATIONS SUCH AS LIFE SUPPORTING, ACTIVE IMPLANTED DEVICES OR SYSTEMS WITH PRODUCT FUNCTIONAL SAFETY REQUIREMENTS; (B) AERONAUTIC APPLICATIONS; (C) AUTOMOTIVE APPLICATIONS OR ENVIRONMENTS, AND/OR (D) AEROSPACE APPLICATIONS OR ENVIRONMENTS. WHERE ST PRODUCTS ARE NOT DESIGNED FOR SUCH USE, THE PURCHASER SHALL USE PRODUCTS AT PURCHASER'S SOLE RISK, EVEN IF ST HAS BEEN INFORMED IN WRITING OF SUCH USAGE, UNLESS A PRODUCT IS EXPRESSLY DESIGNATED BY ST AS BEING INTENDED FOR "AUTOMOTIVE, AUTOMOTIVE SAFETY OR MEDICAL" INDUSTRY DOMAINS ACCORDING TO ST PRODUCT DESIGN SPECIFICATIONS. PRODUCTS FORMALLY ESCC, QML OR JAN QUALIFIED ARE DEEMED SUITABLE FOR USE IN AEROSPACE BY THE CORRESPONDING GOVERNMENTAL AGENCY.

Resale of ST products with provisions different from the statements and/or technical features set forth in this document shall immediately void any warranty granted by ST for the ST product or service described herein and shall not create or extend in any manner whatsoever, any liability of ST.

ST and the ST logo are trademarks or registered trademarks of ST in various countries.

Information in this document supersedes and replaces all information previously supplied.

The ST logo is a registered trademark of STMicroelectronics. All other names are the property of their respective owners.

© 2013 STMicroelectronics - All rights reserved

STMicroelectronics group of companies

Australia - Belgium - Brazil - Canada - China - Czech Republic - Finland - France - Germany - Hong Kong - India - Israel - Italy - Japan - Malaysia - Malta - Morocco - Philippines - Singapore - Spain - Sweden - Switzerland - United Kingdom - United States of America

www.st.com