

High frequency secondary rectifier

Datasheet - production data

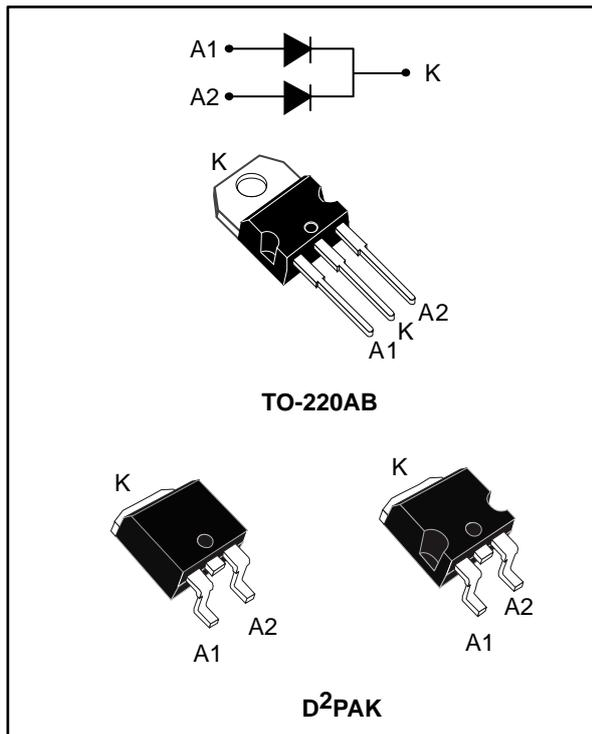

Description

Dual center tap fast recovery epitaxial diodes suited for switch mode power supply and high frequency DC to DC converters.

Packaged either in TO-220AB and D²PAK, this device is particularly intended for secondary rectification inside SMPS with high space and power density.

Table 1: Device summary

| Symbol | Value |
|-----------------|----------------|
| $I_{F(AV)}$ | 2 x 10 A |
| V_{RRM} | 300 V |
| T_j | -40 to +175 °C |
| V_F (typ.) | 0.8 V |
| t_{rr} (typ.) | 26 ns |

Features

- Ultrafast, soft and noise-free recovery
- Low forward voltage drop meaning very small conduction losses
- ECOPACK[®]2 compliant component for D²PAK on demand

1 Characteristics

Table 2: Absolute ratings (limiting values, per diode, at 25 °C, unless otherwise specified)

| Symbol | Parameter | | | Value | Unit |
|---------------------|---|-----------------------------------|------------|-------------|------|
| V _{RRM} | Repetitive peak reverse voltage | | | 300 | V |
| I _{F(RMS)} | Forward rms current | | | 30 | A |
| I _{F(AV)} | Average forward current δ = 0.5, square wave | T _C = 155 °C | Per diode | 10 | A |
| | | T _C = 150 °C | Per device | 20 | |
| I _{FSM} | Surge non repetitive forward current | t _p = 10 ms sinusoidal | | 150 | A |
| T _{stg} | Storage temperature range | | | -65 to +175 | °C |
| T _j | Maximum operating junction temperature range | | | -40 to +175 | °C |

Table 3: Thermal parameters

| Symbol | Parameter | | Max. value | Unit |
|----------------------|------------------|-----------|------------|------|
| R _{th(j-c)} | Junction to case | Per diode | 1.5 | °C/W |
| | | Total | 1.0 | |
| R _{th(c)} | Coupling | | 0.5 | °C/W |

When the diodes 1 and 2 are used simultaneously:

$$\Delta T_j (\text{diode1}) = P (\text{diode1}) \times R_{th(j-c)} (\text{per diode}) + P (\text{diode2}) \times R_{th(c)}$$

Table 4: Static electrical characteristics (per diode)

| Symbol | Parameter | Test conditions | | Min. | Typ. | Max. | Unit |
|-------------------------------|-------------------------|-------------------------|-----------------------------------|------|------|------|------|
| I _R ⁽¹⁾ | Reverse leakage current | T _j = 25 °C | V _R = V _{RRM} | - | | 10 | μA |
| | | T _j = 125 °C | | - | 10 | 100 | |
| V _F ⁽²⁾ | Forward voltage drop | T _j = 25 °C | I _F = 10 A | - | 0.95 | 1.2 | V |
| | | T _j = 125 °C | | - | 0.8 | 0.95 | |

Notes:

(1)Pulse test: t_p = 5 ms, δ < 2%

(2)Pulse test: t_p = 380 μs, δ < 2%

To evaluate the conduction losses, use the following equation:

$$P = 0.8 \times I_{F(AV)} + 0.015 \times I_{F(RMS)}^2$$



Table 5: Dynamic electrical characteristics (per diode)

| Symbol | Parameter | Test conditions | | Min. | Typ. | Max. | Unit |
|---------------------|--------------------------|-------------------------|---|------|------|------|------|
| t _{rr} | Reverse recovery time | T _j = 25 °C | I _F = 1 A, V _R = 30 V, dI _F /dt = - 100 A/μs | - | 26 | 35 | ns |
| | | | I _F = 10 A, V _R = 200 V, dI _F /dt = - 200 A/μs | - | 55 | 72 | |
| I _{RM} | Reverse recovery current | T _j = 125 °C | I _F = 10 A, V _R = 200 V, dI _F /dt = - 200 A/μs | - | 9 | 12 | A |
| S _{factor} | Softness factor | | | - | 0.3 | | |
| Q _{RR} | Reverse recovery charges | | | - | 250 | 375 | nC |
| t _{fr} | Forward recovery time | T _j = 25 °C | I _F = 10 A, V _{FR} = 1.05 V, dI _F /dt = 100 A/μs | - | | 200 | ns |
| V _{FP} | Forward recovery voltage | | | - | 2.5 | 3.5 | V |

1.1 Characteristics (curves)

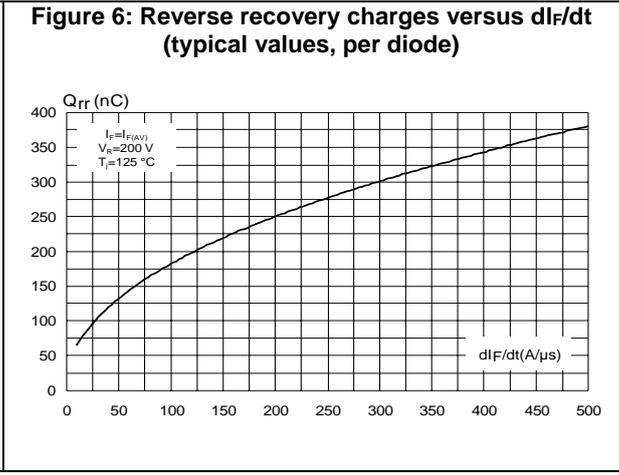
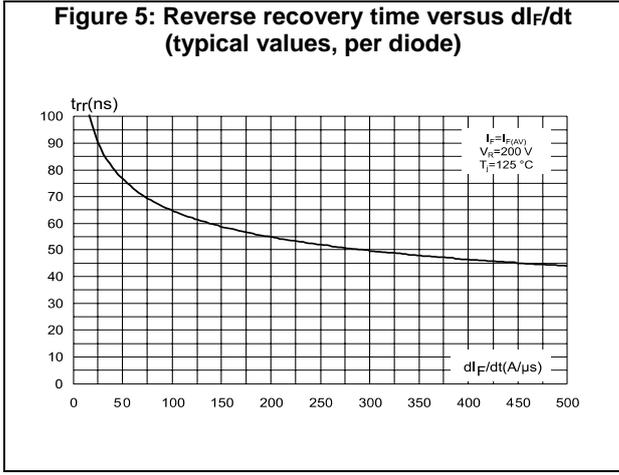
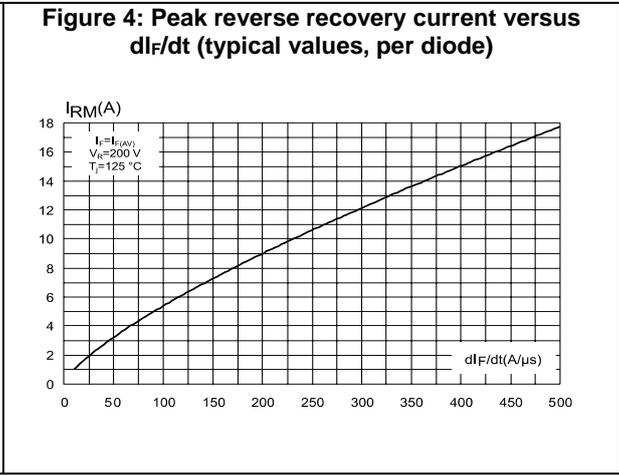
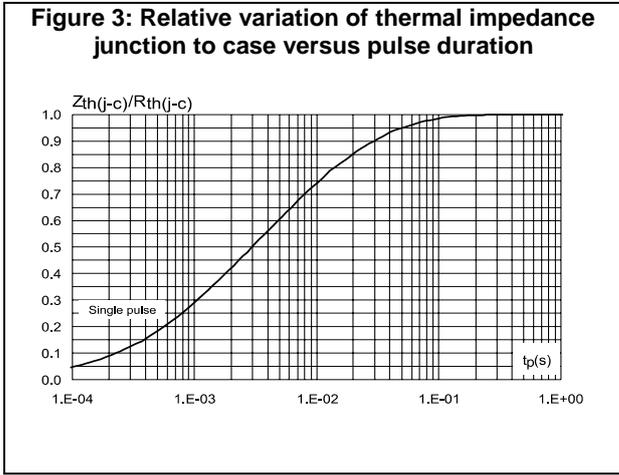
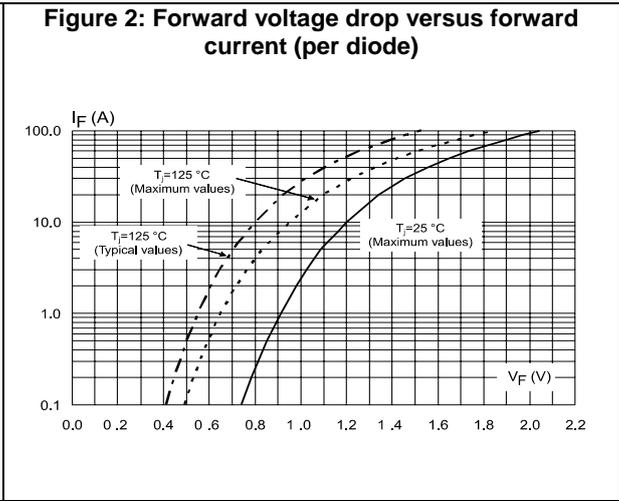
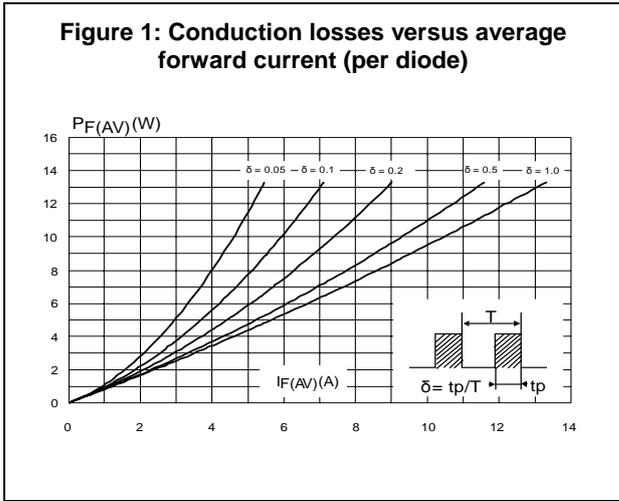

Figure 7: Reverse recovery softness factor versus di_F/dt (typical values, per diode)

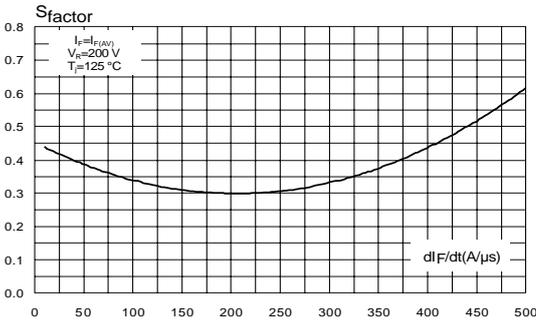

Figure 8: Relative variation of dynamic parameters versus junction temperature

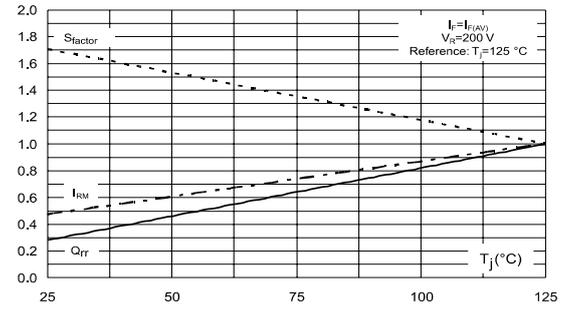

Figure 9: Transient peak forward voltage versus di_F/dt (typical values, per diode)

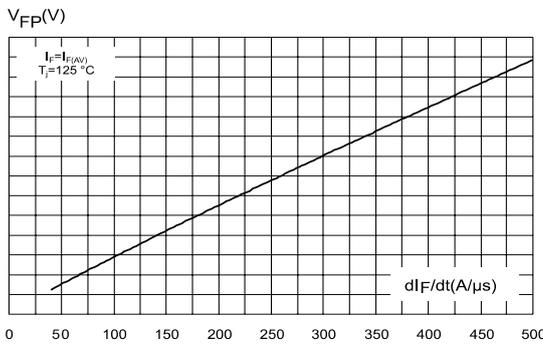

Figure 10: Forward recovery time versus di_F/dt (typical values, per diode)

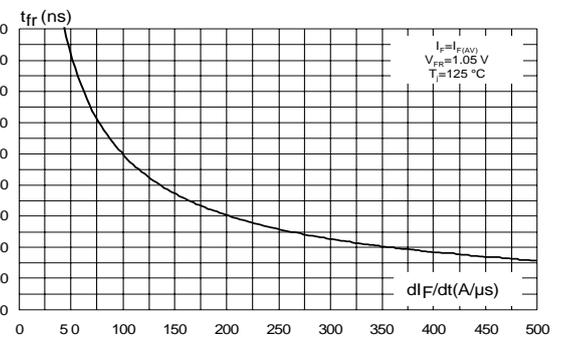

Figure 11: Junction capacitance versus reverse voltage applied (typical values, per diode)

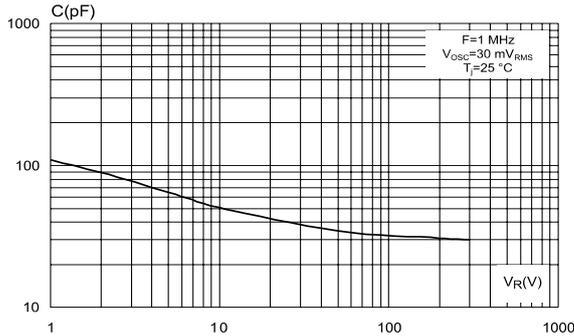
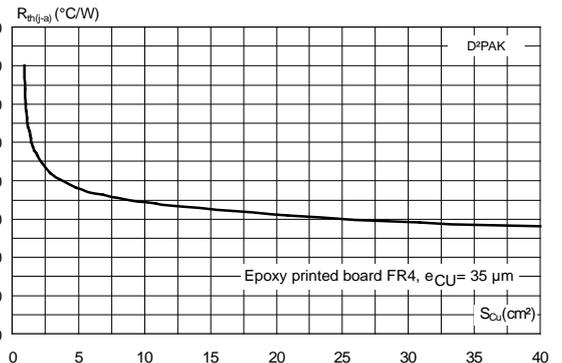

Figure 12: Thermal resistance, junction to ambient, versus copper surface under tab



2 Package information

In order to meet environmental requirements, ST offers these devices in different grades of ECOPACK® packages, depending on their level of environmental compliance. ECOPACK® specifications, grade definitions and product status are available at: www.st.com. ECOPACK® is an ST trademark.

- Cooling method: by conduction (C)
- Epoxy meets UL 94, V0
- Recommended torque value: 0.55 N·m (for TO-220AB)
- Maximum torque value: 0.7 N·m (for TO-220AB)

2.1 D²PAK package information

Figure 13: D²PAK package outline

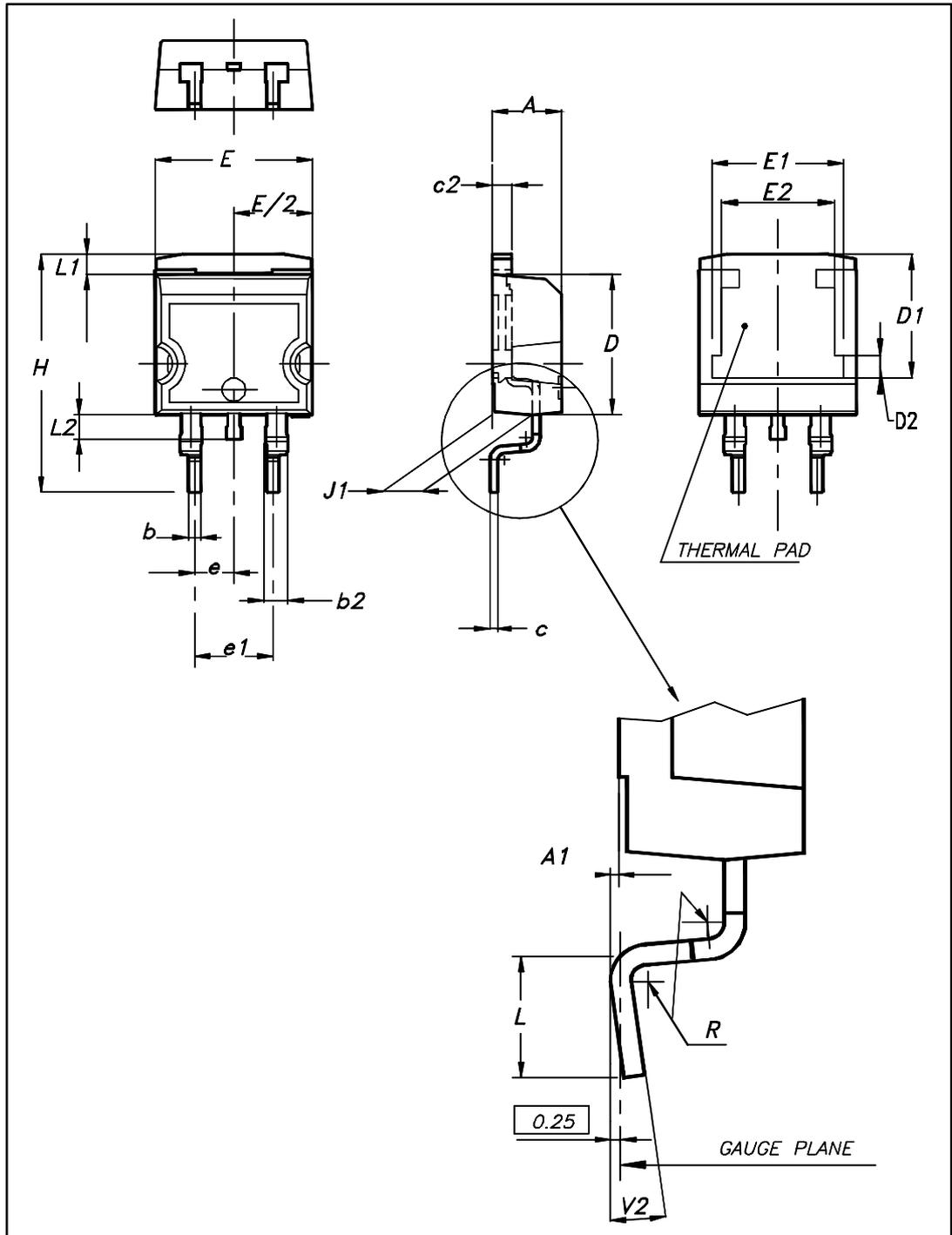

This package drawing may slightly differ from the physical package. However, all the specified dimensions are guaranteed.

Table 6: D²PAK package mechanical data

| Ref. | Dimensions | | | |
|------|-------------|-------|--------|-------|
| | Millimeters | | Inches | |
| | Min. | Max. | Min. | Max. |
| A | 4.36 | 4.60 | 0.172 | 0.181 |
| A1 | 0.00 | 0.25 | 0.000 | 0.010 |
| b | 0.70 | 0.93 | 0.028 | 0.037 |
| b2 | 1.14 | 1.70 | 0.045 | 0.067 |
| c | 0.38 | 0.69 | 0.015 | 0.027 |
| c2 | 1.19 | 1.36 | 0.047 | 0.053 |
| D | 8.60 | 9.35 | 0.339 | 0.368 |
| D1 | 6.90 | 8.00 | 0.272 | 0.311 |
| D2 | 1.10 | 1.50 | 0.043 | 0.060 |
| E | 10.00 | 10.55 | 0.394 | 0.415 |
| E1 | 8.10 | 8.90 | 0.319 | 0.346 |
| E2 | 6.85 | 7.25 | 0.266 | 0.282 |
| e | 2.54 typ. | | 0.100 | |
| e1 | 4.88 | 5.28 | 0.190 | 0.205 |
| H | 15.00 | 15.85 | 0.591 | 0.624 |
| J1 | 2.49 | 2.90 | 0.097 | 0.112 |
| L | 1.90 | 2.79 | 0.075 | 0.110 |
| L1 | 1.27 | 1.65 | 0.049 | 0.065 |
| L2 | 1.30 | 1.78 | 0.050 | 0.070 |
| R | 0.4 typ. | | 0.015 | |
| V2 | 0° | 8° | 0° | 8° |

Figure 14: D²PAK recommended footprint (dimensions in mm)

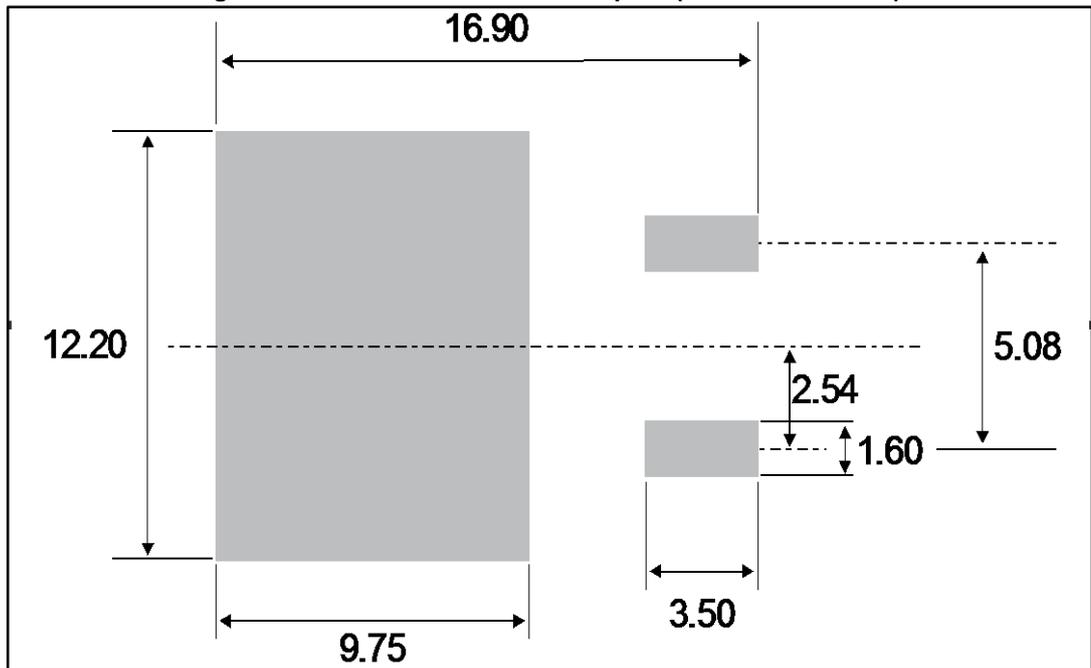

2.2 TO-220AB package information

Figure 15: TO-220AB package outline

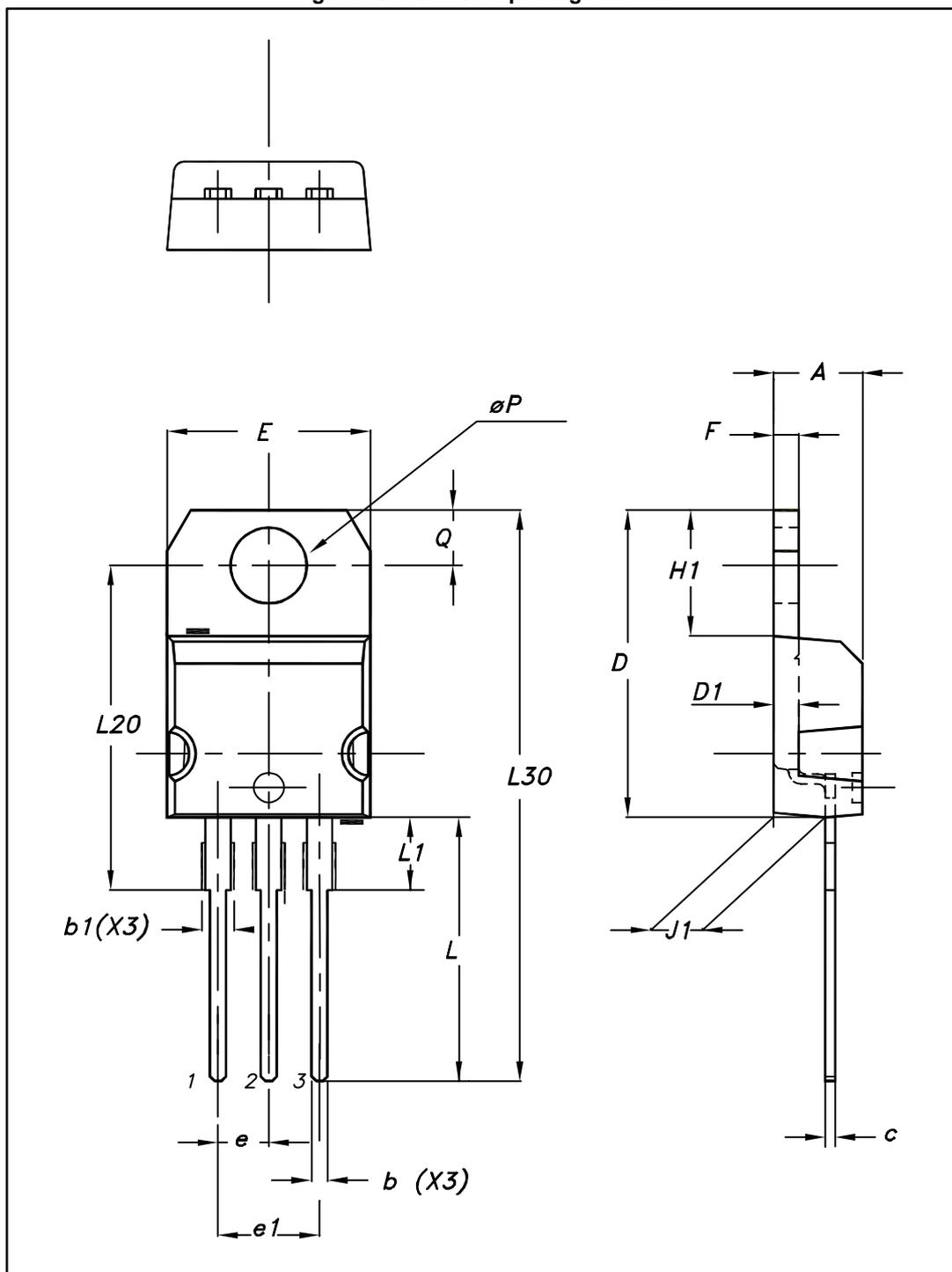

Table 7: TO-220AB package mechanical data

| Ref. | Dimensions | | | |
|------|-------------|-------|------------|-------|
| | Millimeters | | Inches | |
| | Min. | Max. | Min. | Max. |
| A | 4.40 | 4.60 | 0.173 | 0.181 |
| b | 0.61 | 0.88 | 0.240 | 0.035 |
| b1 | 1.14 | 1.70 | 0.045 | 0.067 |
| c | 0.48 | 0.70 | 0.019 | 0.028 |
| D | 15.25 | 15.75 | 0.600 | 0.620 |
| D1 | 1.27 typ. | | 0.050 typ. | |
| E | 10.00 | 10.40 | 0.394 | 0.409 |
| e | 2.40 | 2.70 | 0.094 | 0.106 |
| e1 | 4.95 | 5.15 | 0.195 | 0.203 |
| F | 1.23 | 1.32 | 0.048 | 0.052 |
| H1 | 6.20 | 6.60 | 0.244 | 0.260 |
| J1 | 2.40 | 2.72 | 0.094 | 0.107 |
| L | 13.00 | 14.00 | 0.512 | 0.551 |
| L1 | 3.50 | 3.93 | 0.138 | 0.155 |
| L20 | 16.40 typ. | | 0.646 typ. | |
| L30 | 28.90 typ. | | 1.138 typ. | |
| θP | 3.75 | 3.85 | 0.148 | 0.152 |
| Q | 2.65 | 2.95 | 0.104 | 0.116 |

3 Ordering information

Table 8: Ordering information

| Order code | Marking | Package | Weight | Base qty. | Delivery mode |
|----------------|-------------|--------------------|--------|-----------|---------------|
| STTH20L03CT | STTH20L03CT | TO-220AB | 1.9 g | 50 | Tube |
| STTH20L03CG-TR | STTH20L03CG | D ² PAK | 1.38 g | 1000 | Tape and reel |

4 Revision history

Table 9: Document revision history

| Date | Revision | Changes |
|-------------|----------|---|
| 22-Jun-2012 | 1 | Initial release. |
| 07-Oct-2016 | 2 | Updated cover page and Table 8: "Ordering information" . Updated Section 2.1: "D²PAK package information" . |

IMPORTANT NOTICE – PLEASE READ CAREFULLY

STMicroelectronics NV and its subsidiaries ("ST") reserve the right to make changes, corrections, enhancements, modifications, and improvements to ST products and/or to this document at any time without notice. Purchasers should obtain the latest relevant information on ST products before placing orders. ST products are sold pursuant to ST's terms and conditions of sale in place at the time of order acknowledgement.

Purchasers are solely responsible for the choice, selection, and use of ST products and ST assumes no liability for application assistance or the design of Purchasers' products.

No license, express or implied, to any intellectual property right is granted by ST herein.

Resale of ST products with provisions different from the information set forth herein shall void any warranty granted by ST for such product.

ST and the ST logo are trademarks of ST. All other product or service names are the property of their respective owners.

Information in this document supersedes and replaces information previously supplied in any prior versions of this document.

© 2016 STMicroelectronics – All rights reserved