

# ON Semiconductor

## Is Now

# onsemi™

To learn more about onsemi™, please visit our website at  
[www.onsemi.com](http://www.onsemi.com)

**onsemi** and **onsemi** and other names, marks, and brands are registered and/or common law trademarks of Semiconductor Components Industries, LLC dba "**onsemi**" or its affiliates and/or subsidiaries in the United States and/or other countries. **onsemi** owns the rights to a number of patents, trademarks, copyrights, trade secrets, and other intellectual property. A listing of **onsemi** product/patent coverage may be accessed at [www.onsemi.com/site/pdf/Patent-Marking.pdf](http://www.onsemi.com/site/pdf/Patent-Marking.pdf). **onsemi** reserves the right to make changes at any time to any products or information herein, without notice. The information herein is provided "as-is" and **onsemi** makes no warranty, representation or guarantee regarding the accuracy of the information, product features, availability, functionality, or suitability of its products for any particular purpose, nor does **onsemi** assume any liability arising out of the application or use of any product or circuit, and specifically disclaims any and all liability, including without limitation special, consequential or incidental damages. Buyer is responsible for its products and applications using **onsemi** products, including compliance with all laws, regulations and safety requirements or standards, regardless of any support or applications information provided by **onsemi**. "Typical" parameters which may be provided in **onsemi** data sheets and/or specifications can and do vary in different applications and actual performance may vary over time. All operating parameters, including "Typicals" must be validated for each customer application by customer's technical experts. **onsemi** does not convey any license under any of its intellectual property rights nor the rights of others. **onsemi** products are not designed, intended, or authorized for use as a critical component in life support systems or any FDA Class 3 medical devices or medical devices with a same or similar classification in a foreign jurisdiction or any devices intended for implantation in the human body. Should Buyer purchase or use **onsemi** products for any such unintended or unauthorized application, Buyer shall indemnify and hold **onsemi** and its officers, employees, subsidiaries, affiliates, and distributors harmless against all claims, costs, damages, and expenses, and reasonable attorney fees arising out of, directly or indirectly, any claim of personal injury or death associated with such unintended or unauthorized use, even if such claim alleges that **onsemi** was negligent regarding the design or manufacture of the part. **onsemi** is an Equal Opportunity/Affirmative Action Employer. This literature is subject to all applicable copyright laws and is not for resale in any manner. Other names and brands may be claimed as the property of others.

# MJE700G, MJE702G, MJE703G (PNP), MJE800G, MJE802G, MJE803G (NPN)



ON Semiconductor®

<http://onsemi.com>

## Plastic Darlington Complementary Silicon Power Transistors

These devices are designed for general-purpose amplifier and low-speed switching applications.

### Features

- High DC Current Gain –  $h_{FE} = 2000$  (Typ) @  $I_C = 2.0$  Adc
- Monolithic Construction with Built-in Base-Emitter Resistors to Limit Leakage – Multiplication
- Choice of Packages – MJE700 and MJE800 Series
- These Devices are Pb-Free and are RoHS Compliant\*

### MAXIMUM RATINGS

Rating	Symbol	Value	Unit
Collector-Emitter Voltage MJE700G, MJE800G MJE702G, MJE703G, MJE802G, MJE803G	$V_{CEO}$	60 80	Vdc
Collector-Base Voltage MJE700G, MJE800G MJE702G, MJE703G, MJE802G, MJE803G	$V_{CB}$	60 80	Vdc
Emitter-Base Voltage	$V_{EB}$	5.0	Vdc
Collector Current	$I_C$	4.0	Adc
Base Current	$I_B$	0.1	Adc
Total Power Dissipation @ $T_C = 25^\circ\text{C}$ Derate above $25^\circ\text{C}$	$P_D$	40 0.32	W mW/°C
Operating and Storage Junction Temperature Range	$T_J, T_{stg}$	-55 to +150	°C

Stresses exceeding those listed in the Maximum Ratings table may damage the device. If any of these limits are exceeded, device functionality should not be assumed, damage may occur and reliability may be affected.

### THERMAL CHARACTERISTICS

Characteristic	Symbol	Max	Unit
Thermal Resistance, Junction-to-Case	$R_{\theta JC}$	3.12	°C/W
Thermal Resistance, Junction-to-Ambient	$R_{\theta JA}$	83.3	°C/W

\*For additional information on our Pb-Free strategy and soldering details, please download the ON Semiconductor Soldering and Mounting Techniques Reference Manual, SOLDERRM/D.

## 4.0 AMPERE DARLINGTON POWER TRANSISTORS COMPLEMENTARY SILICON 40 WATT

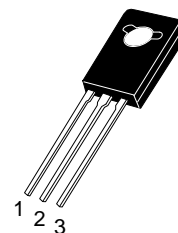
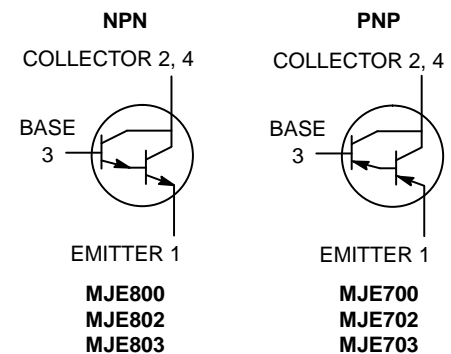

TO-225  
CASE 77-09  
STYLE 1

### MARKING DIAGRAM

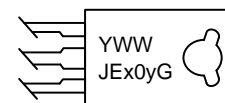

Y = Year  
WW = Work Week  
JEx0y = Device Code  
x = 7 or 8  
y = 0, 2, or 3  
G = Pb-Free Package

### ORDERING INFORMATION

See detailed ordering and shipping information in the package dimensions section on page 5 of this data sheet.

# MJE700G, MJE702G, MJE703G (PNP), MJE800G, MJE802G, MJE803G (NPN)

## ELECTRICAL CHARACTERISTICS (T<sub>C</sub> = 25°C unless otherwise noted)

Characteristic	Symbol	Min	Max	Unit
<b>OFF CHARACTERISTICS</b>				
Collector–Emitter Breakdown Voltage (Note 1) (I <sub>C</sub> = 50 mAdc, I <sub>B</sub> = 0) MJE700G, MJE800G MJE702G, MJE703G, MJE802G, MJE803G	V <sub>(BR)CEO</sub>	60 80	– –	Vdc
Collector Cutoff Current (V <sub>CE</sub> = 60 Vdc, I <sub>B</sub> = 0) MJE700G, MJE800G (V <sub>CE</sub> = 80 Vdc, I <sub>B</sub> = 0) MJE702G, MJE703G, MJE802G, MJE803G	I <sub>CEO</sub>	– –	100 100	μAdc
Collector Cutoff Current (V <sub>CB</sub> = Rated BV <sub>CEO</sub> , I <sub>E</sub> = 0) (V <sub>CB</sub> = Rated BV <sub>CEO</sub> , I <sub>E</sub> = 0, T <sub>C</sub> = 100°C)	I <sub>CBO</sub>	– –	100 500	μAdc
Emitter Cutoff Current (V <sub>BE</sub> = 5.0 Vdc, I <sub>C</sub> = 0)	I <sub>EBO</sub>	–	2.0	mAdc

## ON CHARACTERISTICS

DC Current Gain (Note 1) (I <sub>C</sub> = 1.5 Adc, V <sub>CE</sub> = 3.0 Vdc) MJE700G, MJE702G, MJE800G, MJE802G (I <sub>C</sub> = 2.0 Adc, V <sub>CE</sub> = 3.0 Vdc) MJE703G, MJE803G (I <sub>C</sub> = 4.0 Adc, V <sub>CE</sub> = 3.0 Vdc) All devices	h <sub>FE</sub>	750 750 100	– – –	–
Collector–Emitter Saturation Voltage (Note 1) (I <sub>C</sub> = 1.5 Adc, I <sub>B</sub> = 30 mAdc) MJE700G, MJE702G, MJE800G, MJE802G (I <sub>C</sub> = 2.0 Adc, I <sub>B</sub> = 40 mAdc) MJE703G, MJE803G (I <sub>C</sub> = 4.0 Adc, I <sub>B</sub> = 40 mAdc) All devices	V <sub>CE(sat)</sub>	– – –	2.5 2.8 3.0	Vdc
Base–Emitter On Voltage (Note 1) (I <sub>C</sub> = 1.5 Adc, V <sub>CE</sub> = 3.0 Vdc) MJE700G, MJE702G, MJE800G, MJE802G (I <sub>C</sub> = 2.0 Adc, V <sub>CE</sub> = 3.0 Vdc) MJE703G, MJE803G (I <sub>C</sub> = 4.0 Adc, V <sub>CE</sub> = 3.0 Vdc) All devices	V <sub>BE(on)</sub>	– – –	2.5 2.5 3.0	Vdc

## DYNAMIC CHARACTERISTICS

Small–Signal Current Gain (I <sub>C</sub> = 1.5 Adc, V <sub>CE</sub> = 3.0 Vdc, f = 1.0 MHz)	h <sub>fe</sub>	1.0	–	–
---	-----------------	-----	---	---

Product parametric performance is indicated in the Electrical Characteristics for the listed test conditions, unless otherwise noted. Product performance may not be indicated by the Electrical Characteristics if operated under different conditions.

1. Pulse Test: Pulse Width ≤ 300 μs, Duty Cycle ≤ 2.0%.

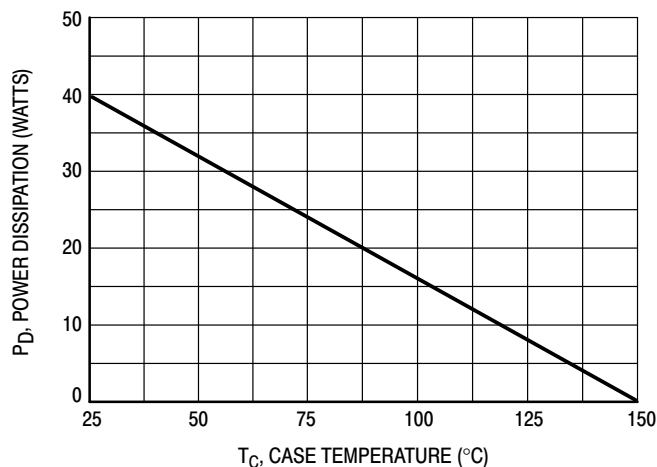

Figure 1. Power Derating

# MJE700G, MJE702G, MJE703G (PNP), MJE800G, MJE802G, MJE803G (NPN)

$R_B$  &  $R_C$  VARIED TO OBTAIN DESIRED CURRENT LEVELS  
 $D_1$ , MUST BE FAST RECOVERY TYPE, e.g.:  
 1N5825 USED ABOVE  $I_B \approx 100$  mA  
 MSD6100 USED BELOW  $I_B \approx 100$  mA

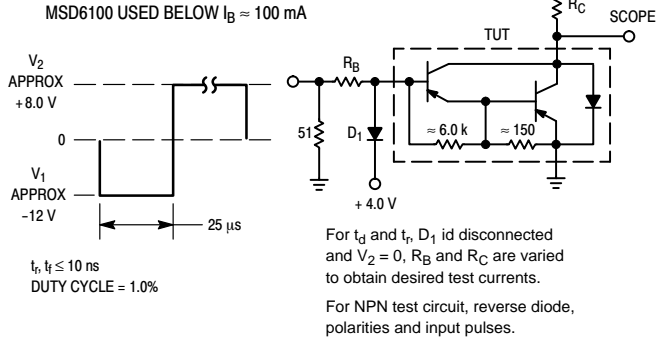

Figure 2. Switching Times Test Circuit

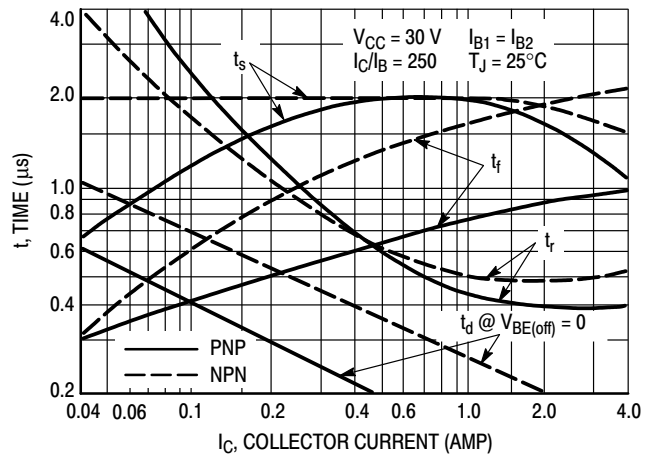

Figure 3. Switching Times

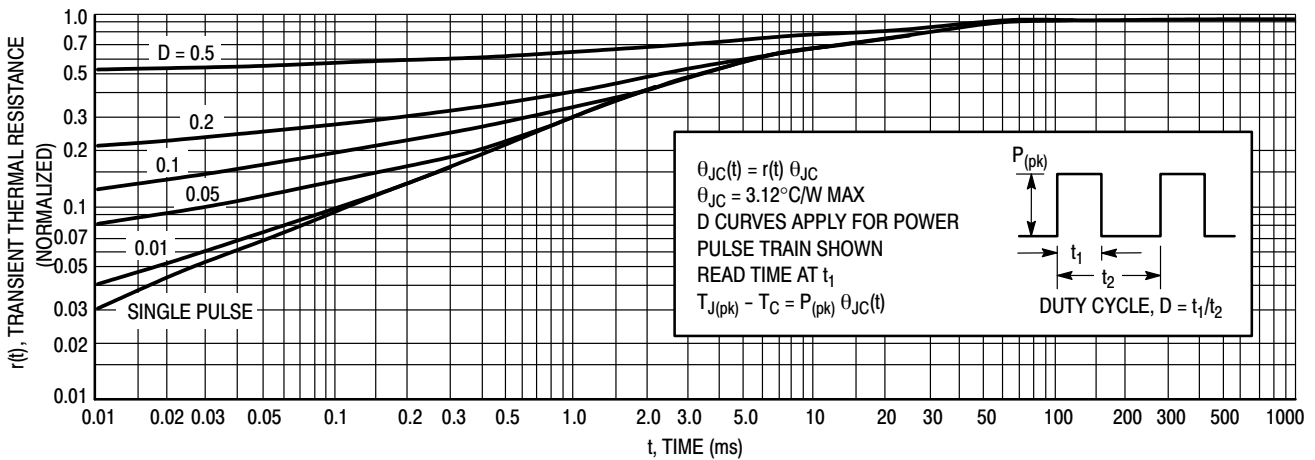

Figure 4. Thermal Response (MJE700, 800 Series)

## ACTIVE-REGION SAFE-OPERATING AREA

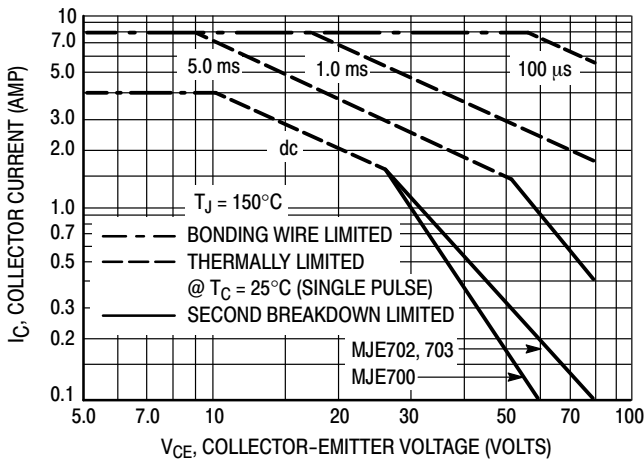

Figure 5. MJE700 Series

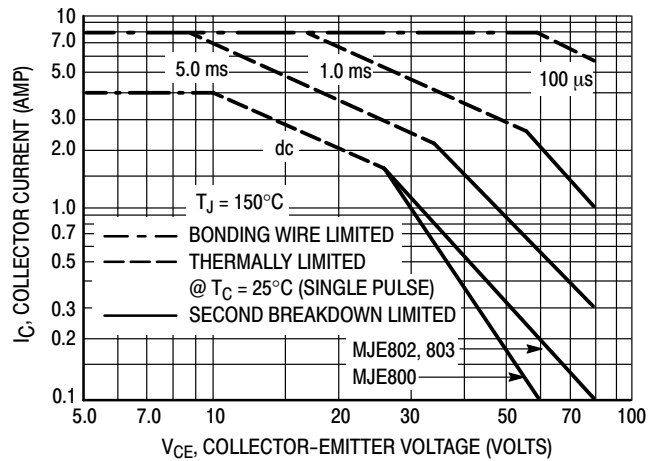

Figure 6. MJE800 Series

There are two limitations on the power handling ability of a transistor: average junction temperature and second breakdown. Safe operating area curves indicate  $I_C - V_{CE}$  limits of the transistor that must be observed for reliable operation; i.e., the transistor must not be subjected to greater dissipation than the curves indicate.

The data of Figures 5 and 6 are based on  $T_{J(pk)} = 150^\circ\text{C}$ ;  $T_C$  is variable depending on conditions. Second breakdown pulse limits are valid for duty cycles to 10% provided  $T_{J(pk)} < 150^\circ\text{C}$ .  $T_{J(pk)}$  may be calculated from the data in Figure 4. At high case temperatures, thermal limitations will reduce the power that can be handled to values less than the limitations imposed by second breakdown.

MJE700G, MJE702G, MJE703G (PNP), MJE800G, MJE802G, MJE803G (NPN)

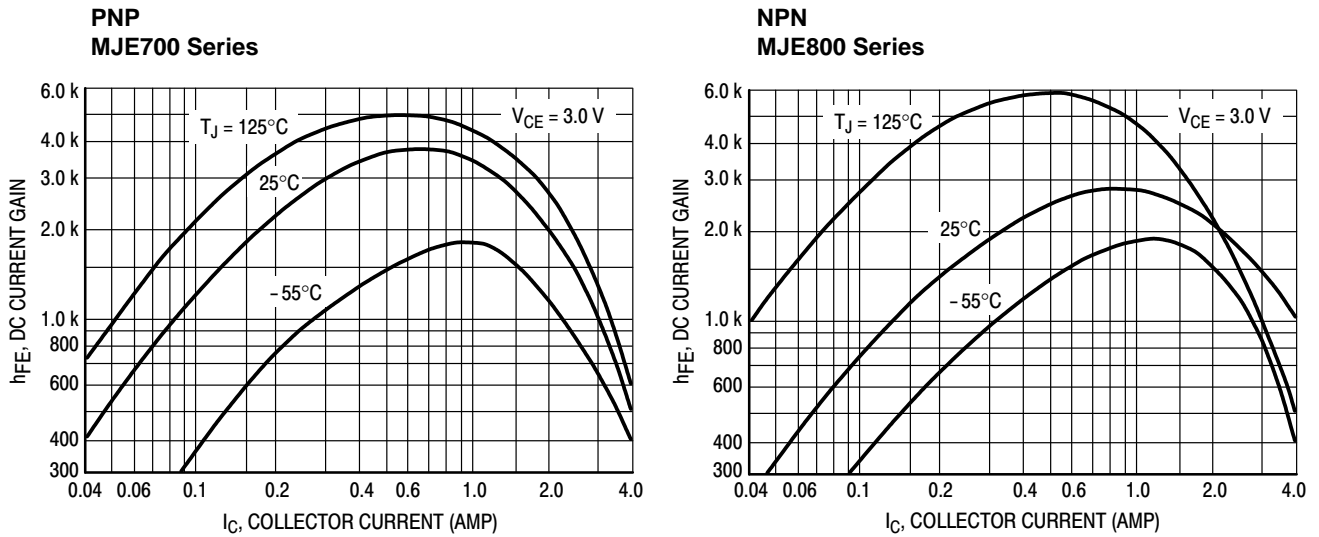

Figure 7. DC Current Gain

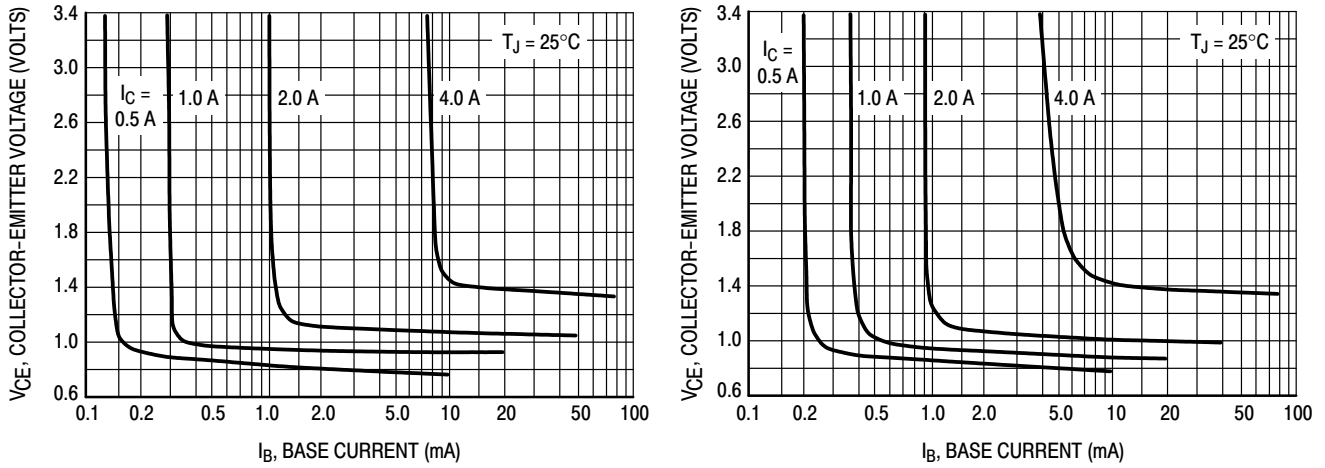

Figure 8. Collector Saturation Region

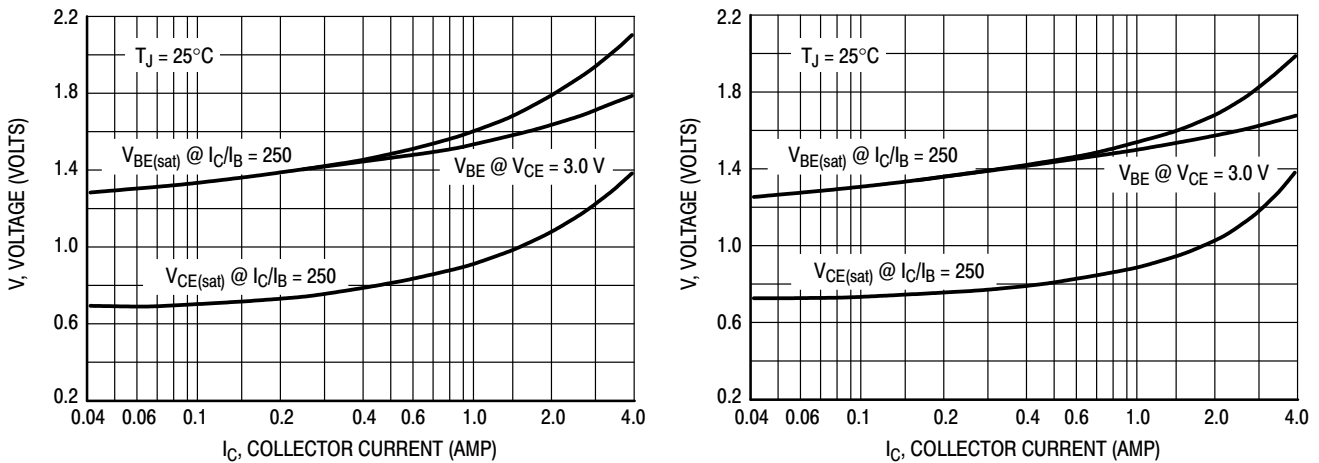

Figure 9. "On" Voltages

# MJE700G, MJE702G, MJE703G (PNP), MJE800G, MJE802G, MJE803G (NPN)

## ORDERING INFORMATION

Device	Package	Shipping
MJE700G	TO-225 (Pb-Free)	50 Units / Bulk
MJE702G	TO-225 (Pb-Free)	50 Units / Bulk
MJE703G	TO-225 (Pb-Free)	50 Units / Bulk
MJE800G	TO-225 (Pb-Free)	50 Units / Bulk
MJE802G	TO-225 (Pb-Free)	50 Units / Bulk
MJE803G	TO-225 (Pb-Free)	50 Units / Bulk

# MECHANICAL CASE OUTLINE

## PACKAGE DIMENSIONS

ON Semiconductor®

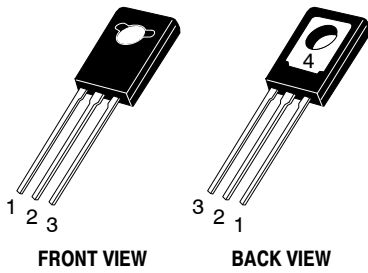

TO-225  
CASE 77-09  
ISSUE AD

DATE 25 MAR 2015

SCALE 1:1

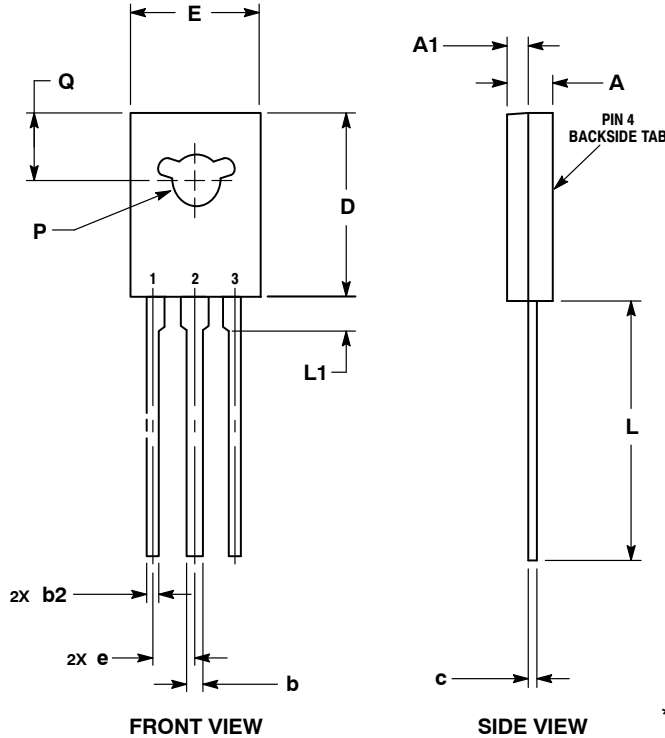

NOTES:

1. DIMENSIONING AND TOLERANCING PER ASME Y14.5M, 1994.
2. CONTROLLING DIMENSION: MILLIMETERS.
3. NUMBER AND SHAPE OF LUGS OPTIONAL.

DIM	MILLIMETERS	
	MIN	MAX
A	2.40	3.00
A1	1.00	1.50
b	0.60	0.90
b2	0.51	0.88
c	0.39	0.63
D	10.60	11.10
E	7.40	7.80
e	2.04	2.54
L	14.50	16.63
L1	1.27	2.54
P	2.90	3.30
Q	3.80	4.20

GENERIC MARKING DIAGRAM\*

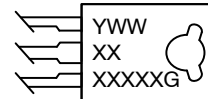

- Y = Year
- WW = Work Week
- XXXXX = Device Code
- G = Pb-Free Package

\*This information is generic. Please refer to device data sheet for actual part marking. Pb-Free indicator, "G" or microdot "µ", may or may not be present.

- |   |   |   |   |   |
|---|---|---|---|---|
| <p>STYLE 1:<br/>PIN 1. EMITTER<br/>2., 4. COLLECTOR<br/>3. BASE</p> | <p>STYLE 2:<br/>PIN 1. CATHODE<br/>2., 4. ANODE<br/>3. GATE</p> | <p>STYLE 3:<br/>PIN 1. BASE<br/>2., 4. COLLECTOR<br/>3. EMITTER</p> | <p>STYLE 4:<br/>PIN 1. ANODE 1<br/>2., 4. ANODE 2<br/>3. GATE</p> | <p>STYLE 5:<br/>PIN 1. MT 1<br/>2., 4. MT 2<br/>3. GATE</p>     |
| <p>STYLE 6:<br/>PIN 1. CATHODE<br/>2., 4. GATE<br/>3. ANODE</p>     | <p>STYLE 7:<br/>PIN 1. MT 1<br/>2., 4. GATE<br/>3. MT 2</p>     | <p>STYLE 8:<br/>PIN 1. SOURCE<br/>2., 4. GATE<br/>3. DRAIN</p>      | <p>STYLE 9:<br/>PIN 1. GATE<br/>2., 4. DRAIN<br/>3. SOURCE</p>    | <p>STYLE 10:<br/>PIN 1. SOURCE<br/>2., 4. DRAIN<br/>3. GATE</p> |

DOCUMENT NUMBER:	98ASB42049B	Electronic versions are uncontrolled except when accessed directly from the Document Repository. Printed versions are uncontrolled except when stamped "CONTROLLED COPY" in red.
DESCRIPTION:	TO-225	PAGE 1 OF 1

ON Semiconductor and are trademarks of Semiconductor Components Industries, LLC dba ON Semiconductor or its subsidiaries in the United States and/or other countries. ON Semiconductor reserves the right to make changes without further notice to any products herein. ON Semiconductor makes no warranty, representation or guarantee regarding the suitability of its products for any particular purpose, nor does ON Semiconductor assume any liability arising out of the application or use of any product or circuit, and specifically disclaims any and all liability, including without limitation special, consequential or incidental damages. ON Semiconductor does not convey any license under its patent rights nor the rights of others.

ON Semiconductor and  are trademarks of Semiconductor Components Industries, LLC dba ON Semiconductor or its subsidiaries in the United States and/or other countries. ON Semiconductor owns the rights to a number of patents, trademarks, copyrights, trade secrets, and other intellectual property. A listing of ON Semiconductor's product/patent coverage may be accessed at [www.onsemi.com/site/pdf/Patent-Marking.pdf](http://www.onsemi.com/site/pdf/Patent-Marking.pdf). ON Semiconductor reserves the right to make changes without further notice to any products herein. ON Semiconductor makes no warranty, representation or guarantee regarding the suitability of its products for any particular purpose, nor does ON Semiconductor assume any liability arising out of the application or use of any product or circuit, and specifically disclaims any and all liability, including without limitation special, consequential or incidental damages. Buyer is responsible for its products and applications using ON Semiconductor products, including compliance with all laws, regulations and safety requirements or standards, regardless of any support or applications information provided by ON Semiconductor. "Typical" parameters which may be provided in ON Semiconductor data sheets and/or specifications can and do vary in different applications and actual performance may vary over time. All operating parameters, including "Typicals" must be validated for each customer application by customer's technical experts. ON Semiconductor does not convey any license under its patent rights nor the rights of others. ON Semiconductor products are not designed, intended, or authorized for use as a critical component in life support systems or any FDA Class 3 medical devices or medical devices with a same or similar classification in a foreign jurisdiction or any devices intended for implantation in the human body. Should Buyer purchase or use ON Semiconductor products for any such unintended or unauthorized application, Buyer shall indemnify and hold ON Semiconductor and its officers, employees, subsidiaries, affiliates, and distributors harmless against all claims, costs, damages, and expenses, and reasonable attorney fees arising out of, directly or indirectly, any claim of personal injury or death associated with such unintended or unauthorized use, even if such claim alleges that ON Semiconductor was negligent regarding the design or manufacture of the part. ON Semiconductor is an Equal Opportunity/Affirmative Action Employer. This literature is subject to all applicable copyright laws and is not for resale in any manner.

## PUBLICATION ORDERING INFORMATION

### LITERATURE FULFILLMENT:

Email Requests to: [orderlit@onsemi.com](mailto:orderlit@onsemi.com)

ON Semiconductor Website: [www.onsemi.com](http://www.onsemi.com)

### TECHNICAL SUPPORT

North American Technical Support:  
Voice Mail: 1 800-282-9855 Toll Free USA/Canada  
Phone: 011 421 33 790 2910

Europe, Middle East and Africa Technical Support:

Phone: 00421 33 790 2910

For additional information, please contact your local Sales Representative

