

100 V power Schottky rectifier

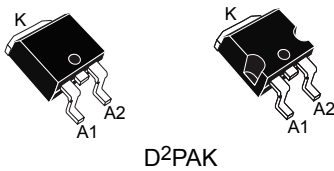
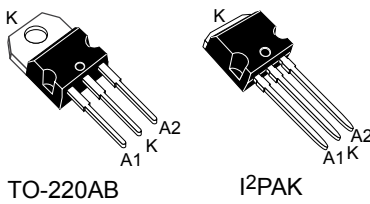
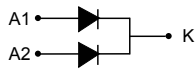

Features

- Negligible switching losses
- Low leakage current
- Good trade-off between leakage current and forward voltage drop
- Low thermal resistance
- Avalanche specification
- ECOPACK[®]2 compliant

Applications

- Switching diode
- SMPS
- DC/DC converter
- LED lighting
- Desktop power supply

Description

This dual center tab Schottky rectifier is suited for switch mode power supply and high frequency DC to DC converters.

Packaged in D²PAK, I²PAK and TO-220AB, the **STPS41H100C** is optimized for use in high frequency inverters.

Product status link	
STPS41H100C	
Product summary	
Symbol	Value
$I_{F(AV)}$	2 x 20 A
V_{RRM}	100 V
T_j	175 °C
V_F (typ.)	0.62 V

1 Characteristics

Table 1. Absolute ratings (limiting values, per diode, at 25 °C, unless otherwise specified)

Symbol	Parameter		Value	Unit	
V _{RRM}	Repetitive peak reverse voltage		100	V	
I _{F(RMS)}	Forward rms current		30	A	
I _{F(AV)}	Average forward current, $\delta = 0.5$ square wave	T _c = 150 °C	Per diode	20	A
			Per device	40	
I _{FSM}	Surge non repetitive forward current	t _p = 10 ms sinusoidal	220	A	
P _{ARM}	Repetitive peak avalanche power	t _p = 10 μ s, T _j = 125 °C	1300	W	
T _{stg}	Storage temperature range		-65 to +175	°C	
T _j	Maximum operating junction temperature range ⁽¹⁾		175	°C	

1. $(dP_{tot}/dT_j) < (1/R_{th(j-a)})$ condition to avoid thermal runaway for a diode on its own heatsink.

Table 2. Thermal resistance parameters

Symbol	Parameter		Max. value	Unit
R _{th(j-c)}	Junction to case	Per diode	1.5	°C/W
		Total	0.8	
R _{th(c)}	Coupling		0.1	

When the diodes 1 and 2 are used simultaneously :

$$\Delta T_j(\text{diode 1}) = P(\text{diode1}) \times R_{th(j-c)}(\text{per diode}) + P(\text{diode 2}) \times R_{th(c)}$$

For more information, please refer to the following application note:

- AN5088 : Rectifiers thermal management, handling and mounting recommendations

Table 3. Static electrical characteristics (per diode)

Symbol	Parameter	Test conditions		Min.	Typ.	Max.	Unit
I _R ⁽¹⁾	Reverse leakage current	T _j = 25 °C	V _R = V _{RRM}	-		10	μ A
		T _j = 125 °C		-	3	10	mA
V _F ⁽²⁾	Forward voltage drop	T _j = 25 °C	I _F = 20 A	-		0.80	V
		T _j = 125 °C		-	0.62	0.67	
		T _j = 25 °C	I _F = 40 A	-		0.90	
		T _j = 125 °C		-	0.70	0.76	

1. Pulse test: t_p = 5 ms, $\delta < 2\%$

2. Pulse test: t_p = 380 μ s, $\delta < 2\%$

To evaluate the conduction losses, use the following equation: $P = 0.58 \times I_{F(AV)} + 0.0045 \times I_{F(RMS)}^2$

For more information, please refer to the following application notes related to the power losses :

- AN604: Calculation of conduction losses in a power rectifier
- AN4021: Calculation of reverse losses on a power diode

1.1 Characteristics (curves)

Figure 1. Average forward power dissipation versus average forward current (per diode)

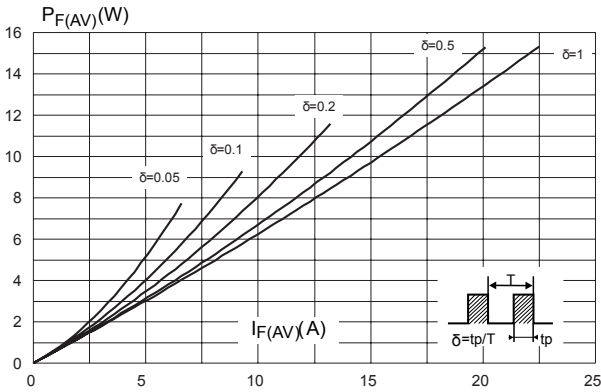

Figure 2. Average forward current versus ambient temperature ($\delta = 0.5$, per diode)

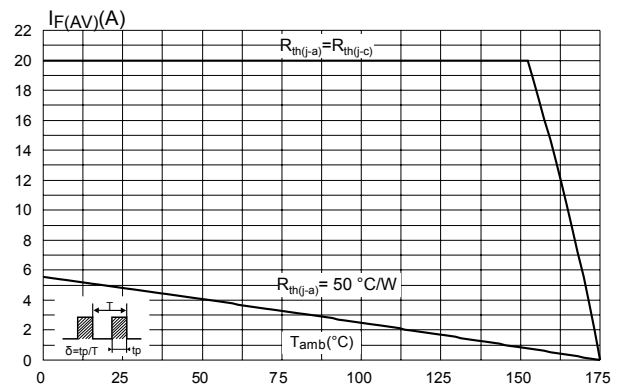

Figure 3. Normalized avalanche power derating versus pulse duration ($T_j = 125$ °C)

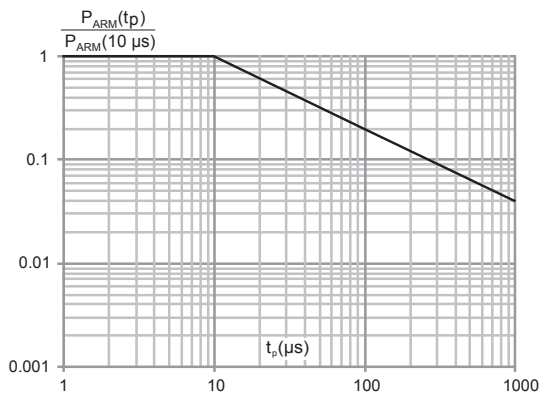

Figure 4. Relative variation of thermal impedance junction to case versus pulse duration

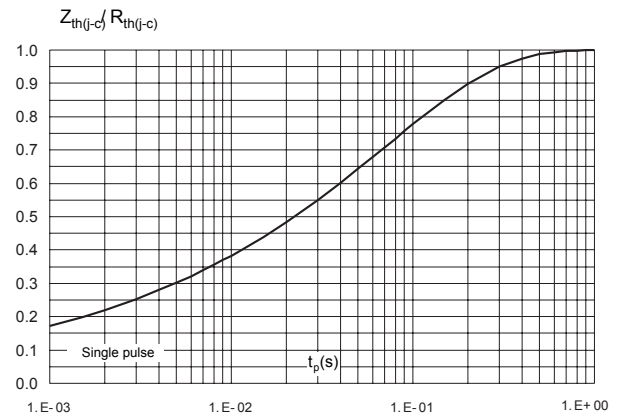

Figure 5. Reverse leakage current versus reverse voltage applied (typical values, per diode)

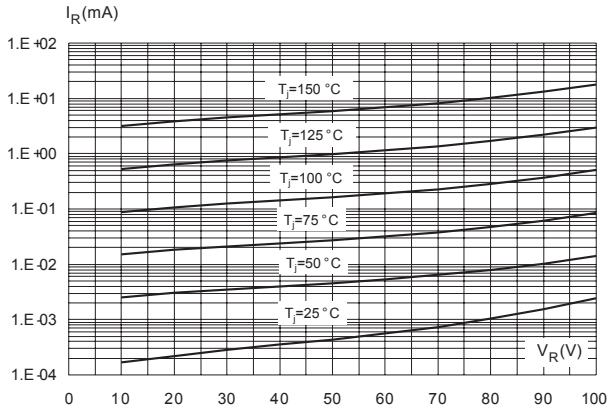

Figure 6. Junction capacitance versus reverse voltage applied (typical values, per diode)

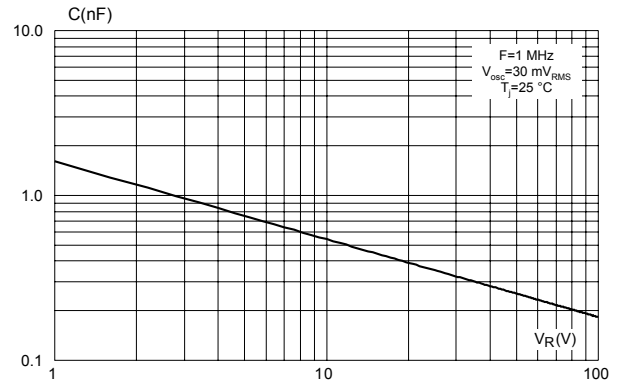

Figure 7. Forward voltage drop versus forward current (per diode)

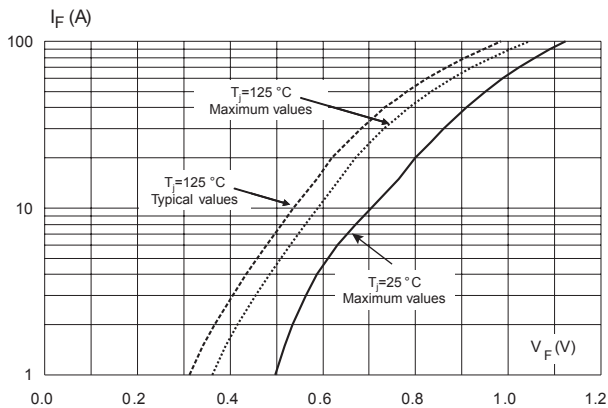

Figure 8. Thermal resistance junction to ambient versus copper surface under tab

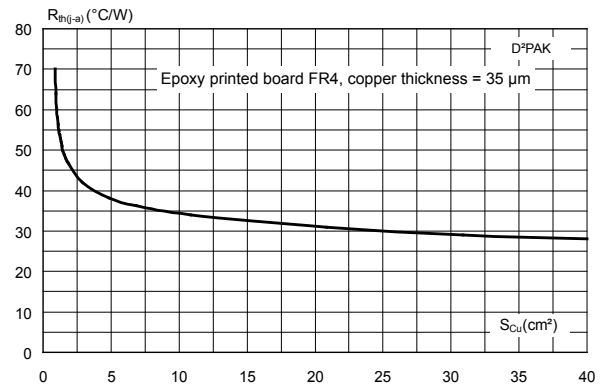

Table 4. TO-220AB package mechanical data

Ref.	Dimensions			
	Millimeters		Inches (for reference only)	
	Min.	Max.	Min.	Max.
A	4.40	4.60	0.173	0.181
b	0.61	0.88	0.240	0.035
b1	1.14	1.55	0.045	0.061
c	0.48	0.70	0.019	0.028
D	15.25	15.75	0.600	0.620
D1	1.27 typ.		0.050 typ.	
E	10.00	10.40	0.394	0.409
e	2.40	2.70	0.094	0.106
e1	4.95	5.15	0.195	0.203
F	1.23	1.32	0.048	0.052
H1	6.20	6.60	0.244	0.260
J1	2.40	2.72	0.094	0.107
L	13.00	14.00	0.512	0.551
L1	3.50	3.93	0.138	0.155
L20	16.40 typ.		0.646 typ.	
L30	28.90 typ.		1.138 typ.	
θP	3.75	3.85	0.148	0.152
Q	2.65	2.95	0.104	0.116

2.2 I²PAK package information

- Epoxy meets UL 94, V0
- Cooling method: by conduction (C)

Figure 10. I²PAK package outline

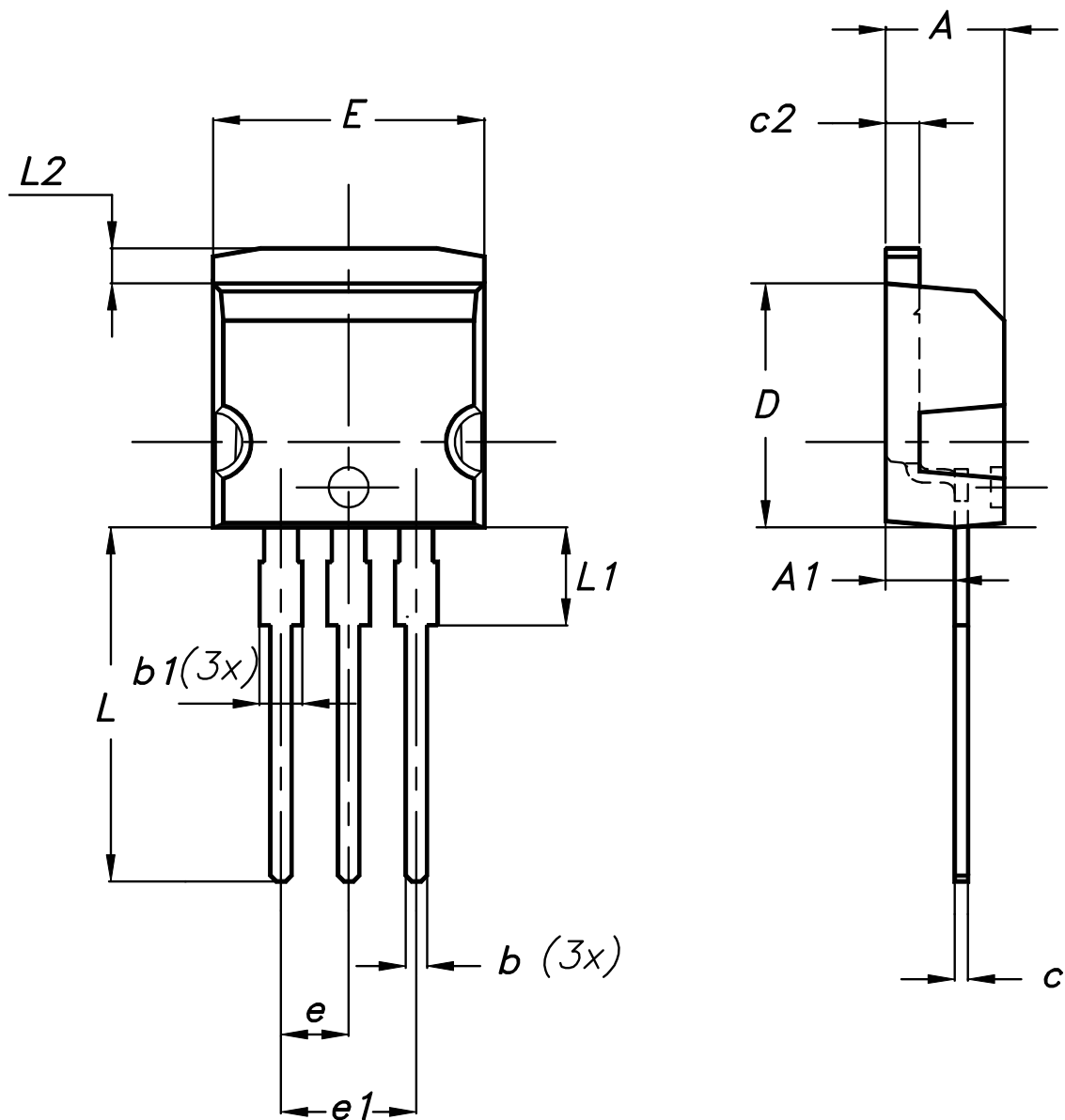

Table 5. I²PAK package mechanical data

Ref.	Dimensions			
	Millimeters		Inches (for reference only)	
	Min.	Max.	Min.	Max.
A	4.40	4.60	0.173	0.181
A1	2.40	2.72	0.094	0.107
b	0.61	0.88	0.024	0.035
b1	1.14	1.70	0.044	0.067
c	0.49	0.70	0.019	0.028
c2	1.23	1.32	0.048	0.052
D	8.95	9.35	0.352	0.368
e	2.40	2.70	0.094	0.106
e1	4.95	5.15	0.195	0.203
E	10.00	10.40	0.394	0.409
L	13.00	14.00	0.512	0.551
L1	3.50	3.93	0.138	0.155
L2	1.27	1.40	0.050	0.055

2.3 D²PAK package information

- Epoxy meets UL94, V0
- Cooling method: by conduction (C)

Figure 11. D²PAK package outline

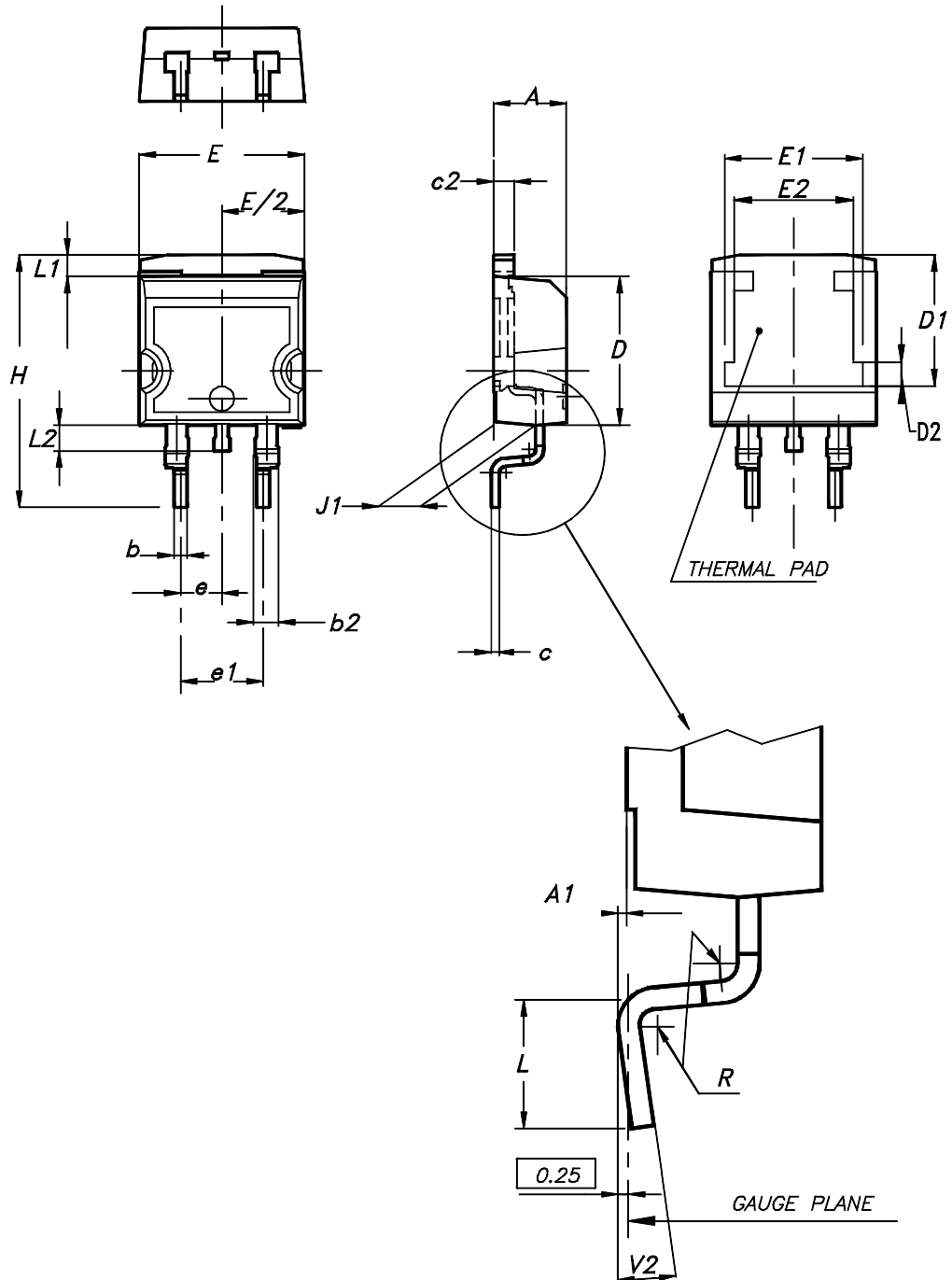

Note: This package drawing may slightly differ from the physical package. However, all the specified dimensions are guaranteed.

Table 6. D²PAK package mechanical data

Ref.	Dimensions			
	Millimeters		Inches (for reference only)	
	Min.	Max.	Min.	Max.
A	4.36	4.60	0.172	0.181
A1	0.00	0.25	0.000	0.010
b	0.70	0.93	0.028	0.037
b2	1.14	1.70	0.045	0.067
c	0.38	0.69	0.015	0.027
c2	1.19	1.36	0.047	0.053
D	8.60	9.35	0.339	0.368
D1	6.90	8.00	0.272	0.311
D2	1.10	1.50	0.043	0.060
E	10.00	10.55	0.394	0.415
E1	8.10	8.90	0.319	0.346
E2	6.85	7.25	0.266	0.282
e	2.54 typ.		0.100	
e1	4.88	5.28	0.190	0.205
H	15.00	15.85	0.591	0.624
J1	2.49	2.90	0.097	0.112
L	1.90	2.79	0.075	0.110
L1	1.27	1.65	0.049	0.065
L2	1.30	1.78	0.050	0.070
R	0.4 typ.		0.015	
V2	0°	8°	0°	8°

Figure 12. D²PAK recommended footprint (dimensions in mm)

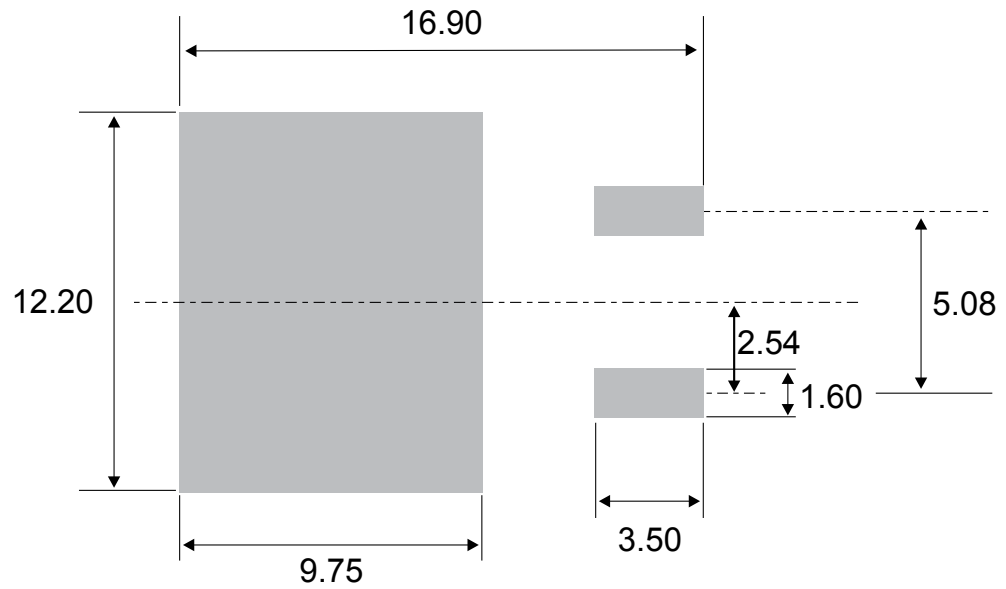

3 Ordering information

Table 7. Ordering information

Order code	Marking	Package	Weight	Base qty.	Delivery mode
STPS41H100CT	STPS41H100CT	TO-220AB	1.95 g	50	Tube
STPS41H100CG	STPS41H100CG	D ² PAK	1.38 g	50	Tube
STPS41H100CG-TR	STPS41H100CG	D ² PAK	1.38 g	10000	Tape and reel
STPS41H100CR	STPS41H100CR	I ² PAK	1.50 g	30	Tube

Revision history

Table 8. Document revision history

Date	Version	Changes
Jul-2003	3A	Previous release.
15-Jul-2011	4	Updated Table 5.
11-Apr-2012	5	Removed order codes STPS41H100CR-H and STPS41H100CT-H. Replaced paragraph under Table 5.
27-Jun-2018	6	Updated Table 1. Absolute ratings (limiting values, per diode, at 25 °C, unless otherwise specified). Updated Section 1.1 Characteristics (curves).

IMPORTANT NOTICE – PLEASE READ CAREFULLY

STMicroelectronics NV and its subsidiaries (“ST”) reserve the right to make changes, corrections, enhancements, modifications, and improvements to ST products and/or to this document at any time without notice. Purchasers should obtain the latest relevant information on ST products before placing orders. ST products are sold pursuant to ST’s terms and conditions of sale in place at the time of order acknowledgement.

Purchasers are solely responsible for the choice, selection, and use of ST products and ST assumes no liability for application assistance or the design of Purchasers’ products.

No license, express or implied, to any intellectual property right is granted by ST herein.

Resale of ST products with provisions different from the information set forth herein shall void any warranty granted by ST for such product.

ST and the ST logo are trademarks of ST. All other product or service names are the property of their respective owners.

Information in this document supersedes and replaces information previously supplied in any prior versions of this document.

© 2018 STMicroelectronics – All rights reserved