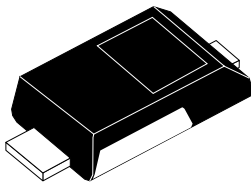

High voltage power Schottky rectifier

STmite Flat

Features

- Negligible switching losses
- High junction temperature capability
- Low leakage current
- Good trade-off between leakage current and forward voltage drop
- Avalanche capability specified

Description

The **STPS1H100MF** is a Schottky rectifier designed for high frequency miniature switch mode power supplies such as adaptors and on-board DC/DC convertors. This device is housed in STmite flat package.

It is ideal for lighting and telecom power applications.

Product status link	
STPS1H100MF	
Product summary	
Symbol	Value
$I_{F(AV)}$	1 A
V_{RRM}	100 V
T_j (max.)	175 °C
V_F (max.)	0.62 V

1 Characteristics

Table 1. Absolute ratings (limiting values at 25 °C, unless otherwise specified)

Symbol	Parameter		Value	Unit
V _{RRM}	Repetitive peak reverse voltage		100	V
I _{F(RMS)}	Forward rms current		2	A
I _{F(AV)}	Average forward current	T _c = 160 °C, δ = 0.5	1	A
I _{FSM}	Surge non repetitive forward current	t _p = 10 ms sinusoidal	50	A
P _{ARM}	Repetitive peak avalanche power	t _p = 10 μs, T _j = 125 °C	108	W
T _{stg}	Storage temperature range		-65 to +175	°C
T _j	Operating junction temperature range ⁽¹⁾		175	°C

1. $(dP_{tot}/dT_j) < (1/R_{th(j-a)})$ condition to avoid thermal runaway for a diode on its own heatsink.

Table 2. Thermal parameters

Symbol	Parameter	Max. value	Unit
R _{th(j-c)}	Junction to case	20	°C/W

Table 3. Static electrical characteristics

Symbol	Parameter	Test conditions		Min.	Typ.	Max.	Unit
I _R ⁽¹⁾	Reverse leakage current	T _j = 25 °C	V _R = V _{RRM}	-		4	μA
		T _j = 125 °C		-	0.2	0.5	mA
V _F ⁽²⁾	Forward voltage drop	T _j = 25 °C	I _F = 1 A	-		0.77	V
		T _j = 125 °C		-	0.58	0.62	
		T _j = 25 °C	I _F = 2 A	-		0.86	
		T _j = 125 °C		-	0.65	0.7	

1. Pulse test: t_p = 5 ms, δ < 2%

2. Pulse test: t_p = 380 μs, δ < 2%

To evaluate the conduction losses, use the following equation:

$$P = 0.54 \times I_{F(AV)} + 0.08 \times I_{F(RMS)}^2$$

1.1 Characteristics (curves)

Figure 1. Average forward power dissipation versus average forward current

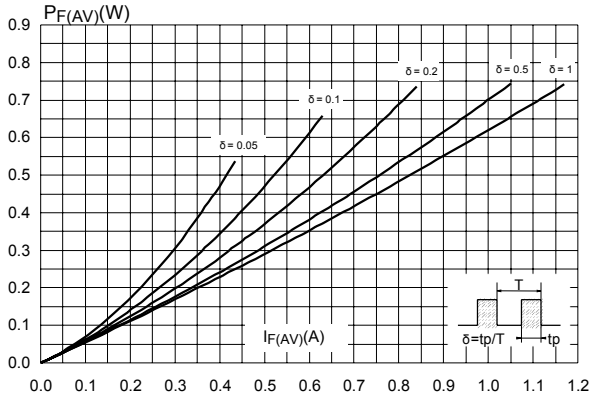

Figure 2. Average forward current versus ambient temperature ($\delta = 0.5$)

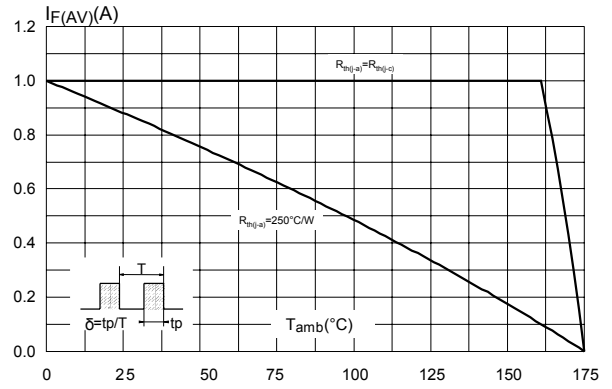

Figure 3. Normalized avalanche power derating versus junction temperature ($T_j = 125^\circ\text{C}$)

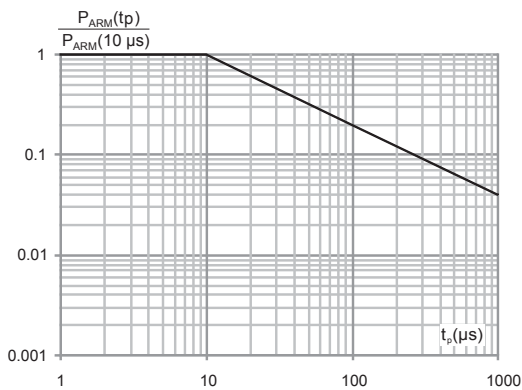

Figure 4. Forward voltage drop versus forward current

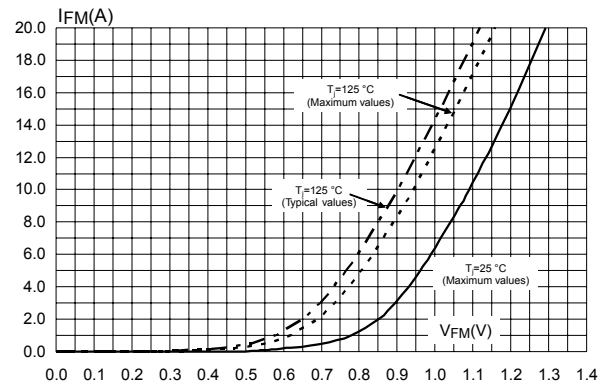

Figure 5. Relative variation of thermal impedance, junction to ambient, versus pulse duration (epoxy printed circuit board, copper thickness = 35 μm , recommended pad layout)

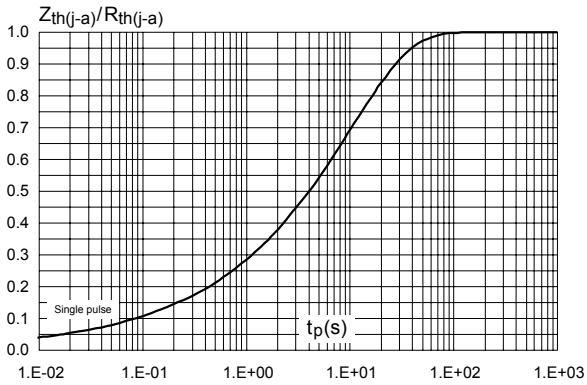

Figure 6. Thermal resistance, junction to ambient, versus copper surface under tab (epoxy printed board FR4, copper thickness = 35 μm)

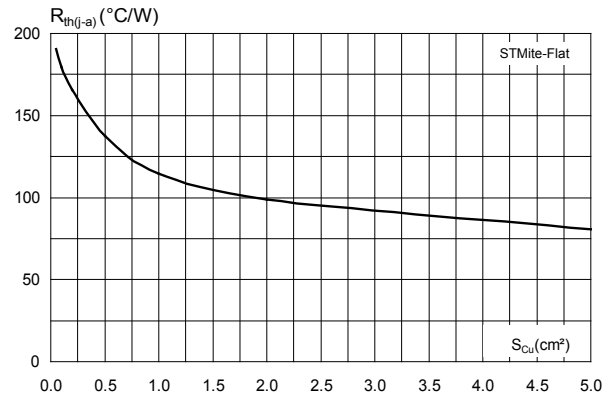

Figure 7. Reverse leakage current versus voltage applied (typical values)

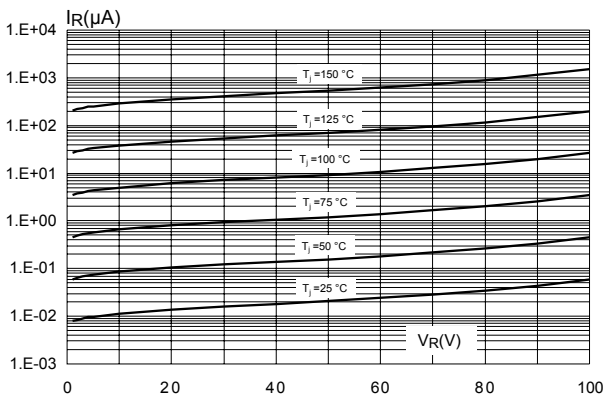
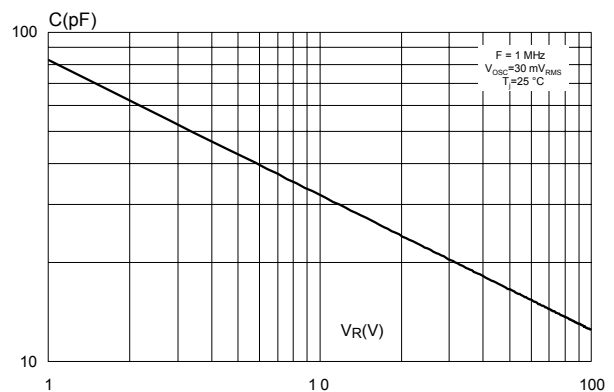

Figure 8. Junction capacitance versus reverse voltage applied (typical values)



2 Package information

In order to meet environmental requirements, ST offers these devices in different grades of ECOPACK® packages, depending on their level of environmental compliance. ECOPACK® specifications, grade definitions and product status are available at: www.st.com. ECOPACK® is an ST trademark.

2.1 STmite Flat package information

- Epoxy meets UL 94,V0

Figure 9. STmite Flat package outline

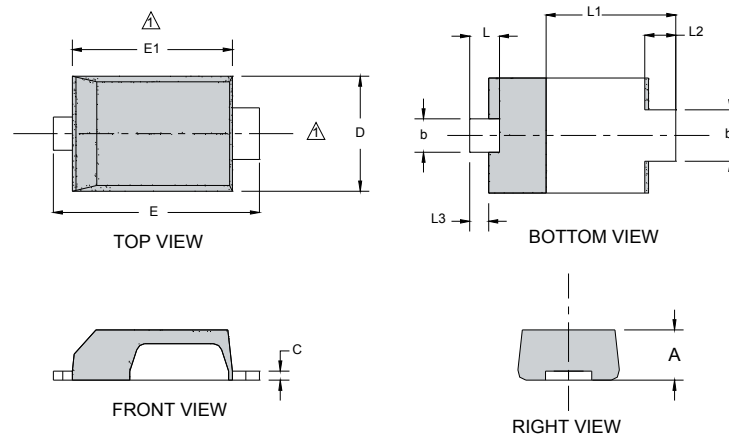
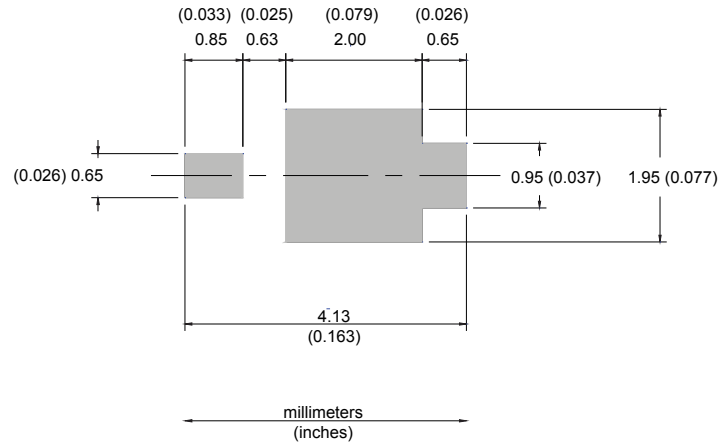

Table 4. STmite Flat package mechanical data

Ref.	Dimensions					
	Millimeters			Inches		
	Min.	Typ.	Max.	Min.	Typ.	Max.
A	0.80	0.85	0.95	0.031	0.033	0.037
b	0.40	0.55	0.65	0.016	0.022	0.026
b2	0.70	0.85	1.00	0.027	0.033	0.039
c	0.10	0.15	0.25	0.004	0.006	0.009
D	1.75	1.90	2.05	0.069	0.075	0.081
E	3.60	3.80	3.90	0.142	0.150	0.154
E1	2.80	2.95	3.10	0.110	0.116	0.122
L	0.50	0.55	0.80	0.020	0.022	0.031
L1	2.10	2.40	2.60	0.083	0.094	0.102
L2	0.45	0.60	0.75	0.018	0.024	0.030
L3	0.20	0.35	0.50	0.008	0.014	0.020

Figure 10. STmite Flat Recommended footprint



3 Ordering information

Table 5. Ordering information

Order code	Marking	Package	Weight	Base qty.	Delivery mode
STPS1H100MF	M11	STmite flat	16 mg	12000	Tape and reel

Revision history

Table 6. Document revision history

Date	Version	Changes
15-May-2008	1	First issue.
10-Apr-2018	2	<p>Removed figure 4 and figure 5.</p> <p>Updated Section • Description, Table 1. Absolute ratings (limiting values at 25 °C, unless otherwise specified) and Figure 3. Normalized avalanche power derating versus junction temperature (T_j = 125 °C).</p> <p>Minor text changes to improve readability.</p>

IMPORTANT NOTICE – PLEASE READ CAREFULLY

STMicroelectronics NV and its subsidiaries (“ST”) reserve the right to make changes, corrections, enhancements, modifications, and improvements to ST products and/or to this document at any time without notice. Purchasers should obtain the latest relevant information on ST products before placing orders. ST products are sold pursuant to ST’s terms and conditions of sale in place at the time of order acknowledgement.

Purchasers are solely responsible for the choice, selection, and use of ST products and ST assumes no liability for application assistance or the design of Purchasers’ products.

No license, express or implied, to any intellectual property right is granted by ST herein.

Resale of ST products with provisions different from the information set forth herein shall void any warranty granted by ST for such product.

ST and the ST logo are trademarks of ST. All other product or service names are the property of their respective owners.

Information in this document supersedes and replaces information previously supplied in any prior versions of this document.

© 2018 STMicroelectronics – All rights reserved