

Automotive-grade silicon carbide Power MOSFET 1200 V, 45 mΩ typ., 55 A in an H²PAK-7 package

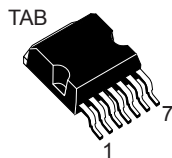

H²PAK-7

N-chG1DS2PS34567DTAB

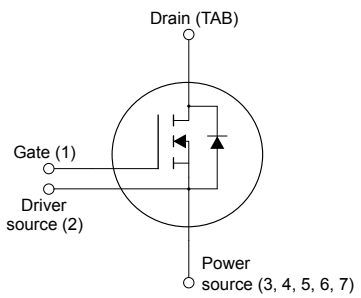

Features

Order code	V _{DS}	R _{DS(on)} max.	I _D
SCTH60N120G2-7AG	1200 V	58 mΩ	55 A

- AEC-Q101 qualified 
- Very fast and robust intrinsic body diode
- Extremely low gate charge and input capacitance
- Source sensing pin for increased efficiency

Applications

- Main inverter (electric traction)
- DC/DC converter for EV/HEV
- On board charger (OBC)

Description

This silicon carbide Power MOSFET device has been developed using ST's advanced and innovative 2nd generation SiC MOSFET technology. The device features remarkably low on-resistance per unit area and very good switching performance. The variation of switching loss is almost independent of junction temperature.

Product status link

[SCTH60N120G2-7AG](#)

Product summary

Order code	SCTH60N120G2-7AG
Marking	60N120AG
Package	H ² PAK-7
Packing	Tape and reel

1 Electrical ratings

Table 1. Absolute maximum ratings

Symbol	Parameter	Value	Unit
V_{DS}	Drain-source voltage	1200	V
V_{GS}	Gate-source voltage	-10 to 22	V
	Gate-source voltage (recommended operational values)	-5 to 18	
I_D	Drain current (continuous) at $T_C = 25\text{ °C}$	55	A
	Drain current (continuous) at $T_C = 100\text{ °C}$	39	
$I_{DM}^{(1)}$	Drain current (pulsed)	156	A
P_{TOT}	Total power dissipation at $T_C = 25\text{ °C}$	385	W
T_{stg}	Storage temperature range	-55 to 175	°C
T_J	Operating junction temperature range		°C

1. Pulse width is limited by safe operating area.

Table 2. Thermal data

Symbol	Parameter	Value	Unit
R_{thJC}	Thermal resistance, junction-to-case	0.39	°C/W
R_{thJA}	Thermal resistance, junction-to-ambient	50	°C/W

2 Electrical characteristics

$T_C = 25\text{ °C}$ unless otherwise specified.

Table 3. On/off states

Symbol	Parameter	Test conditions	Min.	Typ.	Max.	Unit
$V_{(BR)DSS}$	Drain-source breakdown voltage	$V_{GS} = 0\text{ V}, I_D = 1\text{ mA}$	1200			V
I_{DSS}	Zero gate voltage drain current	$V_{GS} = 0\text{ V}, V_{DS} = 1200\text{ V}$			10	μA
I_{GSS}	Gate-body leakage current	$V_{DS} = 0\text{ V}, V_{GS} = -10\text{ to }22\text{ V}$			± 100	nA
$V_{GS(th)}$	Gate threshold voltage	$V_{DS} = V_{GS}, I_D = 1\text{ mA}$	1.9	3.2	5.0	V
$R_{DS(on)}$	Static drain-source on-resistance	$V_{GS} = 18\text{ V}, I_D = 20\text{ A}$		45	58	m Ω
		$V_{GS} = 18\text{ V}, I_D = 20\text{ A}, T_J = 175\text{ °C}$		97		

Table 4. Dynamic

Symbol	Parameter	Test conditions	Min.	Typ.	Max.	Unit
C_{iSS}	Input capacitance	$V_{DS} = 800\text{ V}, f = 1\text{ MHz}, V_{GS} = 0\text{ V}$	-	2086	-	pF
C_{oSS}	Output capacitance		-	90	-	pF
C_{rSS}	Reverse transfer capacitance		-	18	-	pF
Q_g	Total gate charge	$V_{DD} = 800\text{ V}, V_{GS} = -5\text{ to }18\text{ V}, I_D = 30\text{ A}$	-	101	-	nC
Q_{gs}	Gate-source charge		-	36	-	nC
Q_{gd}	Gate-drain charge		-	23	-	nC
R_g	Gate input resistance	$f = 1\text{ MHz}, I_D = 0\text{ A}$	-	1	-	Ω

Table 5. Switching energy (inductive load)

Symbol	Parameter	Test conditions	Min.	Typ.	Max.	Unit
E_{on}	Turn-on switching energy	$V_{DD} = 800\text{ V}, I_D = 30\text{ A},$	-	490	-	μJ
E_{off}	Turn-off switching energy	$R_G = 4.7\text{ }\Omega, V_{GS} = -5\text{ V to }18\text{ V}$	-	97	-	μJ

Table 6. Switching times

Symbol	Parameter	Test conditions	Min.	Typ.	Max.	Unit
$t_{d(on)}$	Turn-on delay time	$V_{DD} = 800\text{ V}, I_D = 30\text{ A},$ $R_G = 2.2\text{ }\Omega, V_{GS} = -5\text{ to }18\text{ V}$	-	12	-	ns
t_r	Rise time		-	12	-	ns
$t_{d(off)}$	Turn-off delay time		-	24	-	ns
t_f	Fall time		-	10	-	ns

Table 7. Reverse SiC diode characteristics

Symbol	Parameter	Test conditions	Min.	Typ.	Max.	Unit
V_{SD}	Diode forward voltage	$I_{SD} = 30\text{ A}$, $V_{GS} = 0\text{ V}$	-	3.5	-	V
t_{rr}	Reverse recovery time	$I_{SD} = 30\text{ A}$, $di/dt = 2000\text{ A}/\mu\text{s}$, $V_{DD} = 800\text{ V}$	-	57	-	ns
Q_{rr}	Reverse recovery charge		-	238	-	nC
I_{RRM}	Reverse recovery current		-	17	-	A

2.1 Electrical characteristics (curves)

Figure 1. Safe operating area

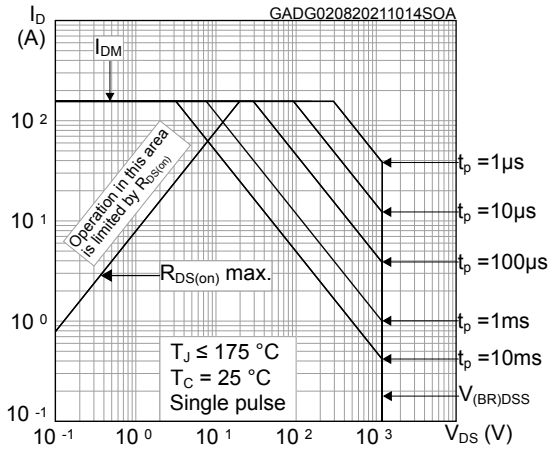

Figure 2. Maximum transient thermal impedance

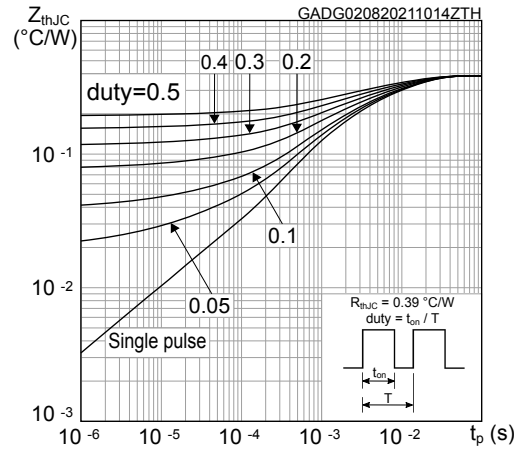

Figure 3. Typical output characteristics ($T_J = 25\text{ }^{\circ}C$)

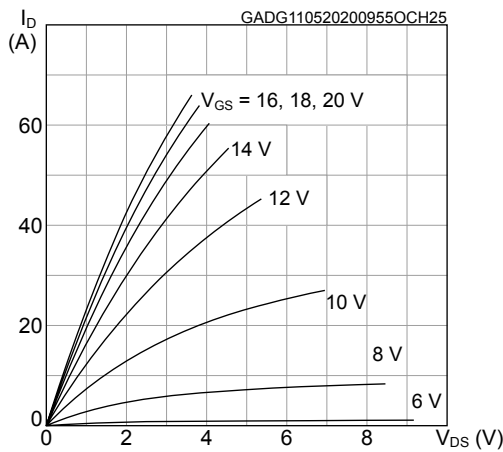

Figure 4. Typical output characteristics ($T_J = 175\text{ }^{\circ}C$)

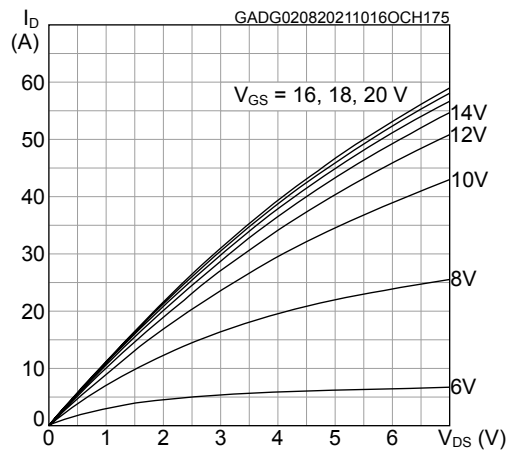

Figure 5. Typical transfer characteristics

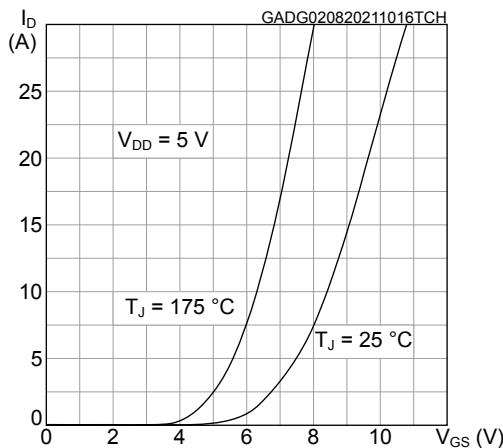

Figure 6. Total power dissipation

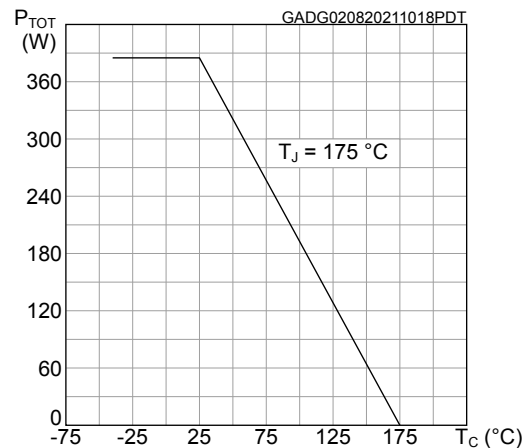

Figure 7. Typical gate charge characteristics

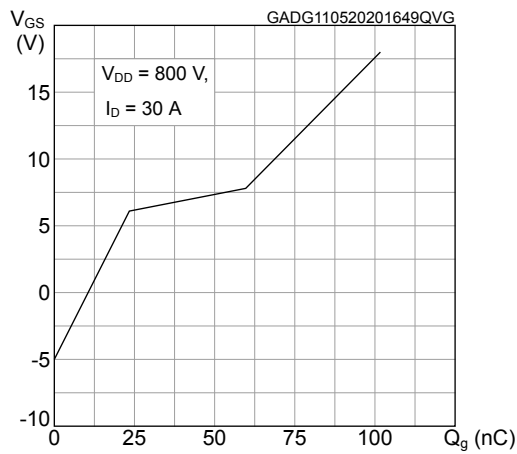

Figure 8. Typical capacitance characteristics

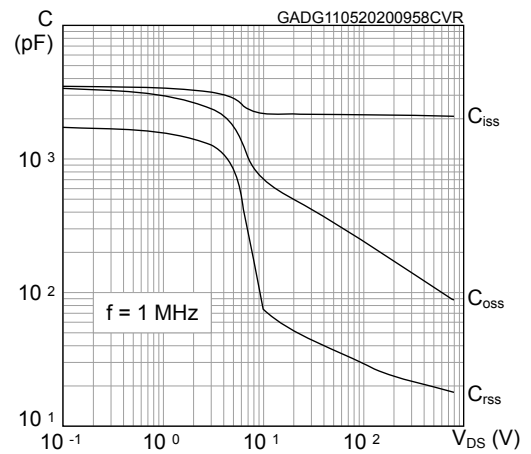

Figure 9. Typical switching energy vs drain current

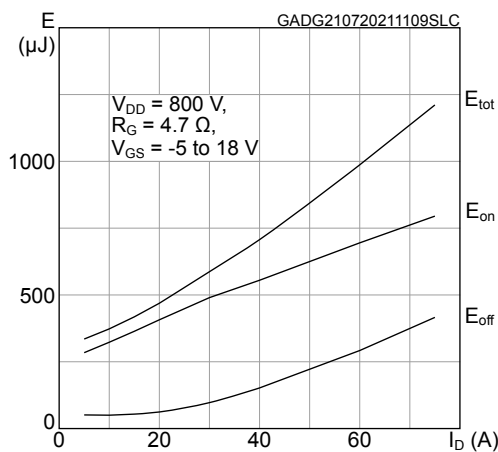

Figure 10. Typical switching energy vs temperature

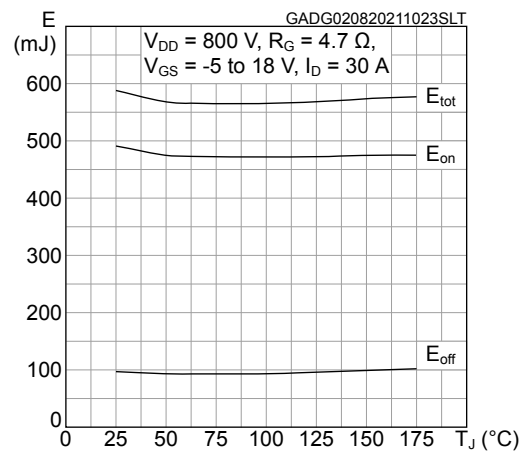

Figure 11. Typical switching energy vs gate resistance

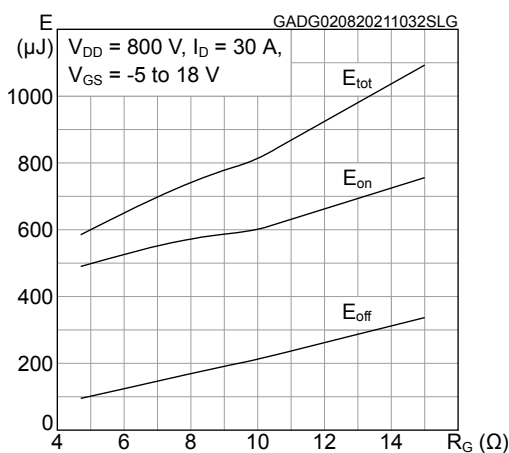

Figure 12. Normalized breakdown voltage vs temperature

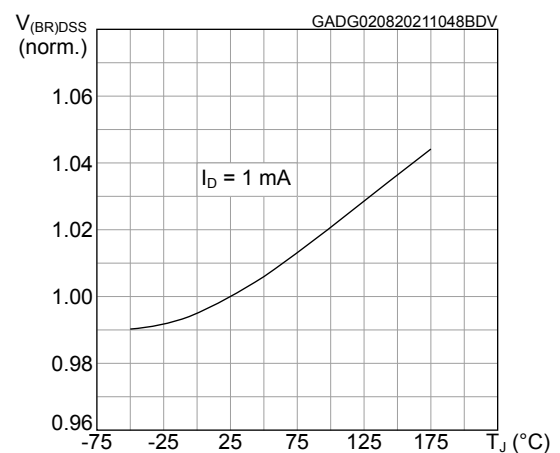

Figure 13. Normalized gate threshold vs temperature

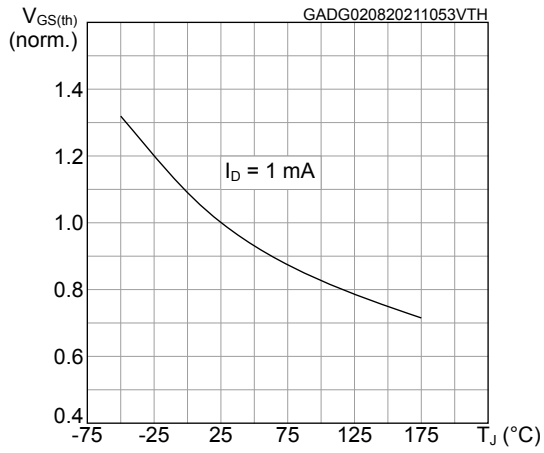

Figure 14. Normalized on-resistance vs temperature

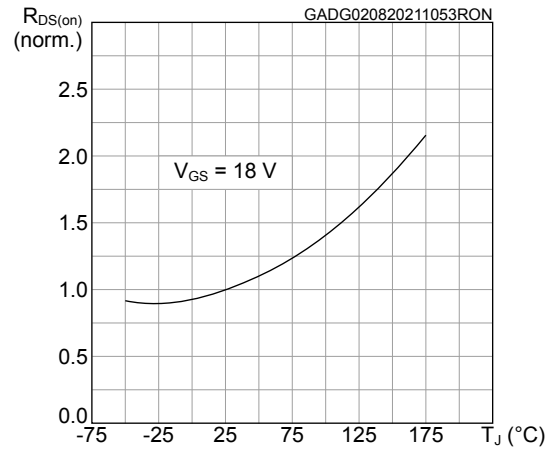
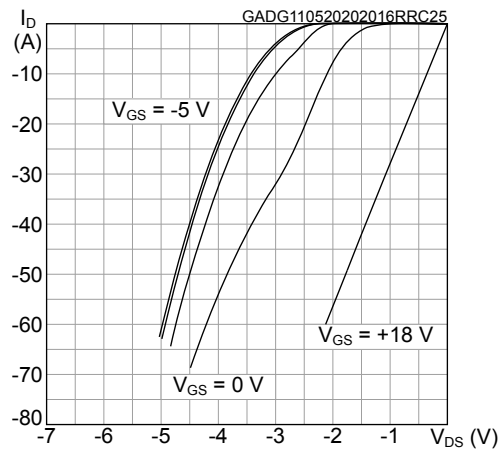

Figure 15. Typical reverse conduction characteristics ($T_J = 25^\circ\text{C}$)



3 Package information

In order to meet environmental requirements, ST offers these devices in different grades of **ECOPACK** packages, depending on their level of environmental compliance. ECOPACK specifications, grade definitions and product status are available at: www.st.com. ECOPACK is an ST trademark.

3.1 H²PAK-7 package information

Figure 16. H²PAK-7 package outline

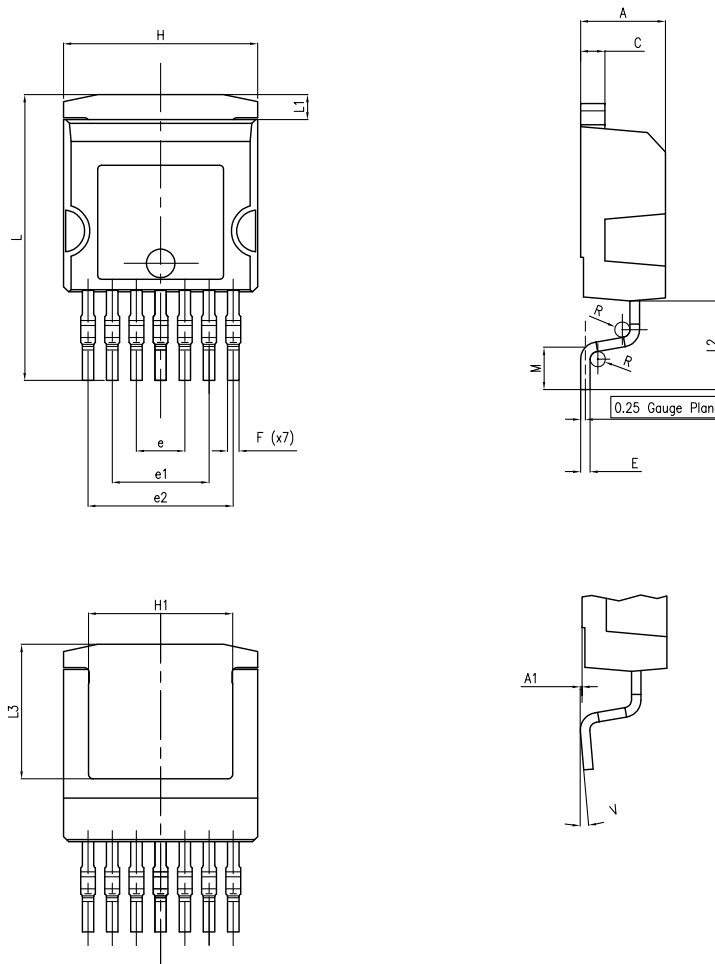
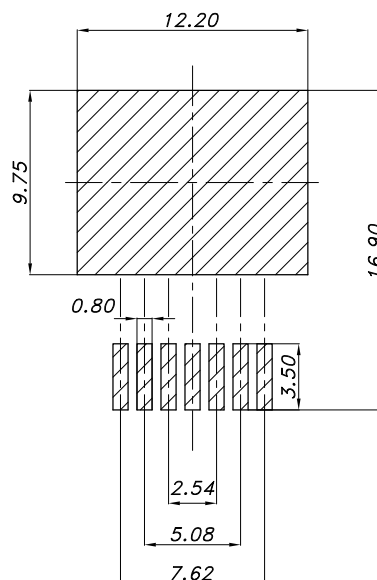

Table 8. H²PAK-7 package mechanical data

Dim.	mm	
	Min.	Max.
A	4.30	4.80
A1	0.03	0.20
C	1.17	1.37
e	2.34	2.74
e1	4.88	5.28
e2	7.42	7.82
E	0.45	0.60
F	0.50	0.70
H	10.00	10.40
H1	7.40	7.60
L	14.75	15.25
L1	1.27	1.40
L2	4.35	4.95
L3	6.85	7.25
M	1.90	2.50
R	0.20	0.60
V	0°	8°

Figure 17. H²PAK-7 recommended footprint



footprint_DM00249216_4

Note: Dimensions are in mm.

3.2 Packing information

Figure 18. Tape outline

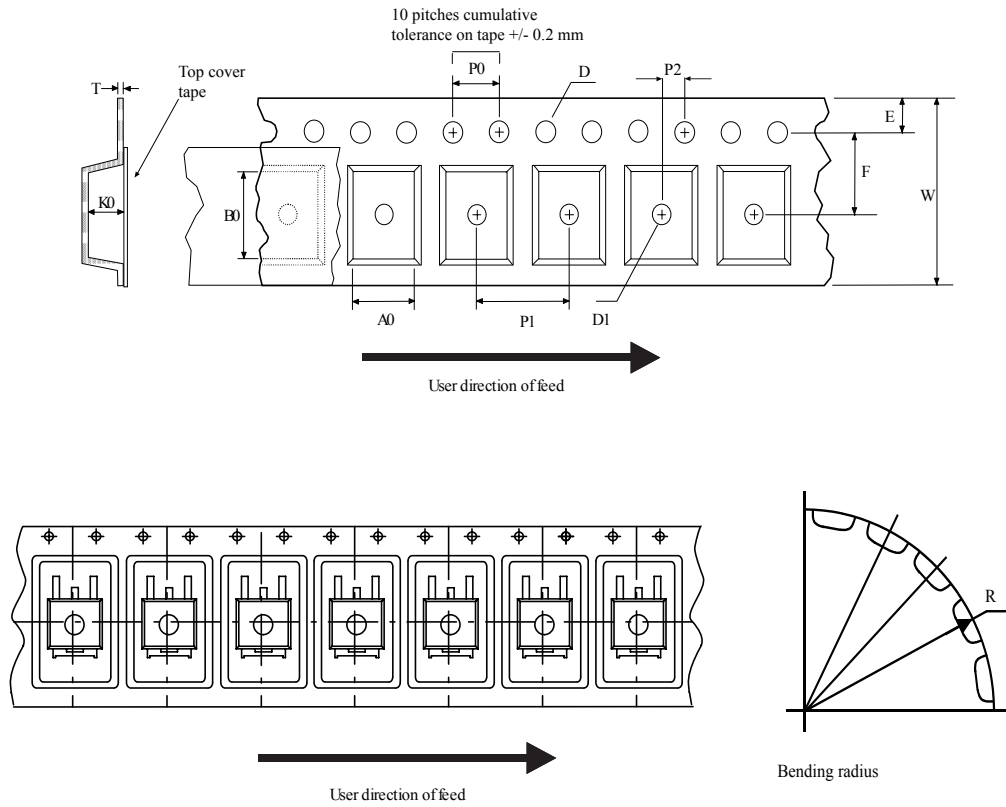

AM08852v2

Figure 19. Reel outline

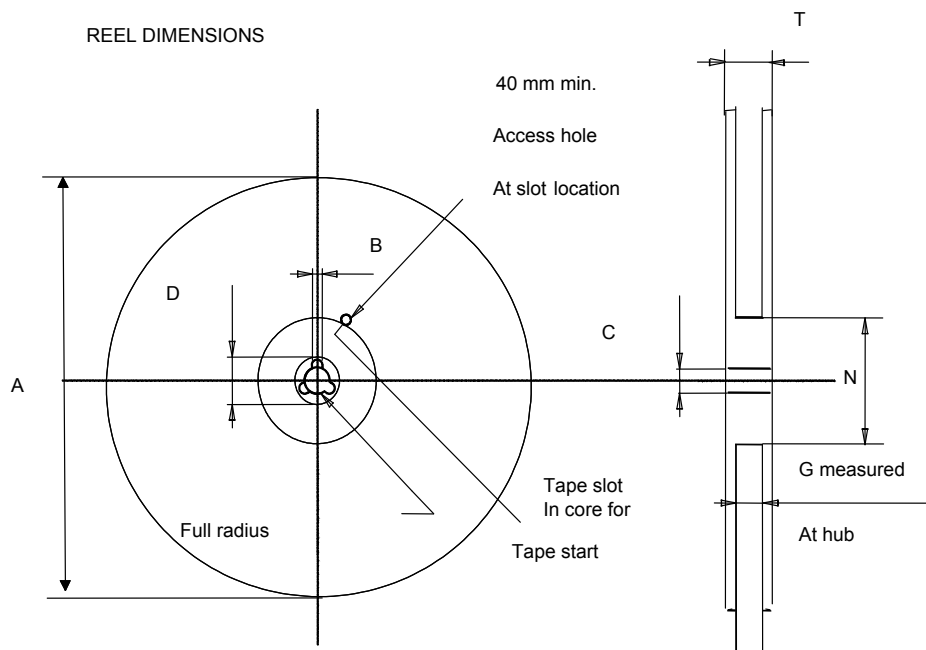

Table 9. Tape and reel mechanical data

Tape			Reel		
Dim.	mm		Dim.	mm	
	Min.	Max.		Min.	Max.
A0	10.5	10.7	A		330
B0	15.7	15.9	B	1.5	
D	1.5	1.6	C	12.8	13.2
D1	1.59	1.61	D	20.2	
E	1.65	1.85	G	24.4	26.4
F	11.4	11.6	N	100	
K0	4.8	5.0	T		30.4
P0	3.9	4.1			
P1	11.9	12.1	Base quantity		1000
P2	1.9	2.1	Bulk quantity		1000
R	50				
T	0.25	0.35			
W	23.7	24.3			

Revision history

Table 10. Document revision history

Date	Revision	Changes
02-Aug-2021	1	First release.

Contents

1	Electrical ratings	2
2	Electrical characteristics	3
2.1	Electrical characteristics (curves)	5
3	Package information	8
3.1	H ² PAK-7 package information	8
3.2	Packing information	10
	Revision history	12

IMPORTANT NOTICE – PLEASE READ CAREFULLY

STMicroelectronics NV and its subsidiaries (“ST”) reserve the right to make changes, corrections, enhancements, modifications, and improvements to ST products and/or to this document at any time without notice. Purchasers should obtain the latest relevant information on ST products before placing orders. ST products are sold pursuant to ST’s terms and conditions of sale in place at the time of order acknowledgement.

Purchasers are solely responsible for the choice, selection, and use of ST products and ST assumes no liability for application assistance or the design of Purchasers’ products.

No license, express or implied, to any intellectual property right is granted by ST herein.

Resale of ST products with provisions different from the information set forth herein shall void any warranty granted by ST for such product.

ST and the ST logo are trademarks of ST. For additional information about ST trademarks, please refer to www.st.com/trademarks. All other product or service names are the property of their respective owners.

Information in this document supersedes and replaces information previously supplied in any prior versions of this document.

© 2021 STMicroelectronics – All rights reserved