

# N-channel 60 V, 6.8 mΩ typ., 40 A STripFET™ F7 Power MOSFET in a DPAK package

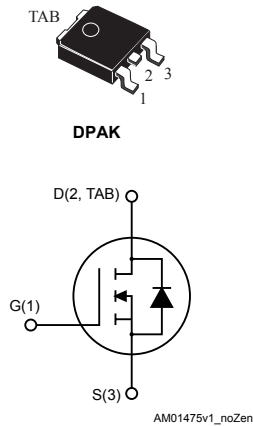

## Features

Order code	V <sub>DS</sub>	R <sub>DS(on)</sub> max.	I <sub>D</sub>
STD80N6F7	60 V	8.0 mΩ	40 A

- Among the lowest R<sub>DS(on)</sub> on the market
- Excellent FoM (figure of merit)
- Low C<sub>rss</sub>/C<sub>iss</sub> ratio for EMI immunity
- High avalanche ruggedness

## Applications

- Switching applications

## Description

This N-channel Power MOSFET utilizes STripFET™ F7 technology with an enhanced trench gate structure that results in very low on-state resistance, while also reducing internal capacitance and gate charge for faster and more efficient switching.

Product status	
STD80N6F7	
Product summary	
Order code	STD80N6F7
Marking	80N6F7
Package	DPAK
Packing	Tape and reel

# 1 Electrical ratings

**Table 1. Absolute maximum ratings**

Symbol	Parameter	Value	Unit
$V_{DS}$	Drain-source voltage	60	V
$V_{GS}$	Gate-source voltage	$\pm 20$	V
$I_D^{(1)}$	Drain current (continuous) at $T_C = 25\text{ }^\circ\text{C}$	40	A
$I_D^{(1)}$	Drain current (continuous) at $T_C = 100\text{ }^\circ\text{C}$	40	A
$I_{DM}^{(2)(1)}$	Drain current (pulsed)	160	A
$P_{TOT}$	Total dissipation at $T_C = 25\text{ }^\circ\text{C}$	100	W
$E_{AS}^{(3)}$	Single pulse avalanche energy	60	mJ
$dv/dt^{(4)}$	Peak diode recovery	4.3	V/ns
$T_j$	Operating junction temperature range	-55 to 175	$^\circ\text{C}$
$T_{stg}$	Storage temperature range		

1. This value is limited by package
2. Pulse width limited by safe operating area
3. Starting  $T_j = 25\text{ }^\circ\text{C}$ ,  $I_{AS} = 20\text{ A}$ ,  $V_{DD} = 40\text{ V}$ .
4.  $I_{SD} = 20\text{ A}$ ,  $di/dt = 700\text{ A}/\mu\text{s}$ ,  $V_{DD} = 48\text{ V}$ .

**Table 2. Thermal data**

Symbol	Parameter	Value	Unit
$R_{thj-pcb}^{(1)}$	Thermal resistance junction-pcb	50	$^\circ\text{C}/\text{W}$
$R_{thj-case}$	Thermal resistance junction-case	1.5	$^\circ\text{C}/\text{W}$

1. When mounted on FR-4 board of 1 inch<sup>2</sup>, 2oz Cu,  $t < 10\text{ s}$

## 2 Electrical characteristics

$T_C = 25\text{ }^\circ\text{C}$  unless otherwise specified

**Table 3. On/off-state**

Symbol	Parameter	Test conditions	Min.	Typ.	Max.	Unit
$V_{(BR)DSS}$	Drain-source breakdown voltage	$V_{GS} = 0\text{ V}, I_D = 1\text{ mA}$	60			V
$I_{DSS}$	Zero gate voltage drain current	$V_{GS} = 0\text{ V}, V_{DS} = 60\text{ V}$			1	$\mu\text{A}$
$I_{GSS}$	Gate-body leakage current	$V_{GS} = 20\text{ V}, V_{DS} = 0\text{ V}$			100	nA
$V_{GS(th)}$	Gate threshold voltage	$V_{DD} = V_{GS}, I_D = 250\text{ }\mu\text{A}$	2		4	V
$R_{DS(on)}$	Static drain-source on-resistance	$V_{GS} = 10\text{ V}, I_D = 20\text{ A}$		6.8	8.0	m $\Omega$

**Table 4. Dynamic**

Symbol	Parameter	Test conditions	Min.	Typ.	Max.	Unit
$C_{iss}$	Input capacitance	$V_{DS} = 30\text{ V}, f = 1\text{ MHz}, V_{GS} = 0\text{ V}$	-	1600	-	pF
$C_{oss}$	Output capacitance		-	800	-	pF
$C_{rss}$	Reverse transfer capacitance		-	50	-	pF
$Q_g$	Total gate charge	$V_{DD} = 30\text{ V}, I_D = 20\text{ A},$	-	25	-	nC
$Q_{gs}$	Gate-source charge	$V_{GS} = 0\text{ to }10\text{ V}$	-	7.2	-	nC
$Q_{gd}$	Gate-drain charge	(see Figure 13. Test circuit for gate charge behavior)	-	8	-	nC

**Table 5. Switching times**

Symbol	Parameter	Test conditions	Min.	Typ.	Max.	Unit
$t_{d(on)}$	Turn-on delay time	$V_{DD} = 30\text{ V}, I_D = 20\text{ A}, R_G = 4.7\text{ }\Omega, V_{GS} = 10\text{ V}$ (see Figure 12. Test circuit for resistive load switching times and Figure 17. Switching time waveform)	-	15	-	ns
$t_r$	Rise time		-	17.6	-	ns
$t_{d(off)}$	Turn-off delay time		-	24.4	-	ns
$t_f$	Fall time		-	7.8	-	ns

**Table 6. Source-drain diode**

Symbol	Parameter	Test conditions	Min.	Typ.	Max.	Unit
$V_{SD}^{(1)}$	Forward on voltage	$I_{SD} = 40\text{ A}, V_{DD} = 0\text{ V}$	-		1.2	V
$t_{rr}$	Reverse recovery time	$I_D = 40\text{ A}, di/dt = 100\text{ A}/\mu\text{s}, V_{DD} = 48\text{ V}$	-	39.6		ns
$Q_{rr}$	Reverse recovery charge	(see Figure 14. Test circuit for inductive load switching and diode recovery times)	-	36		nC
$I_{RRM}$	Reverse recovery current		-	1.8		A

1. Pulsed: pulse duration = 300  $\mu\text{s}$ , duty cycle 1.5%

## 2.1 Electrical characteristics (curves)

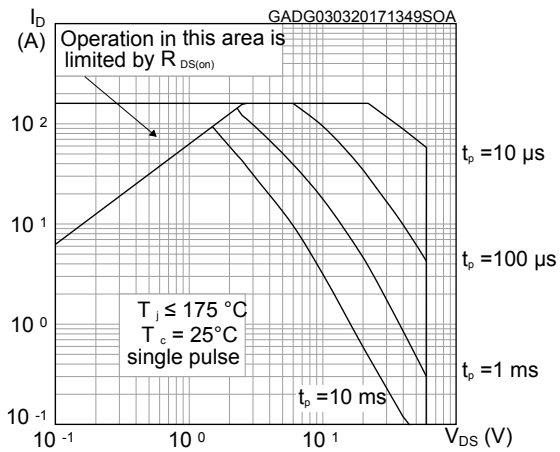
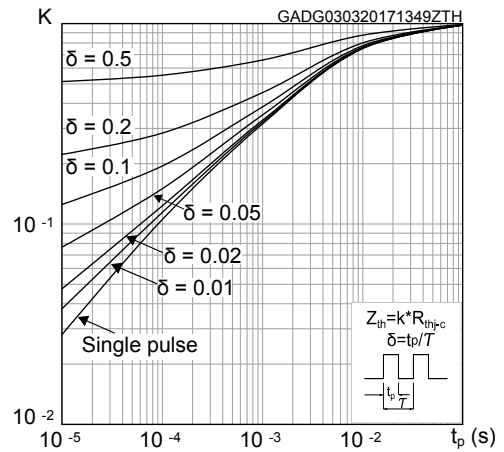
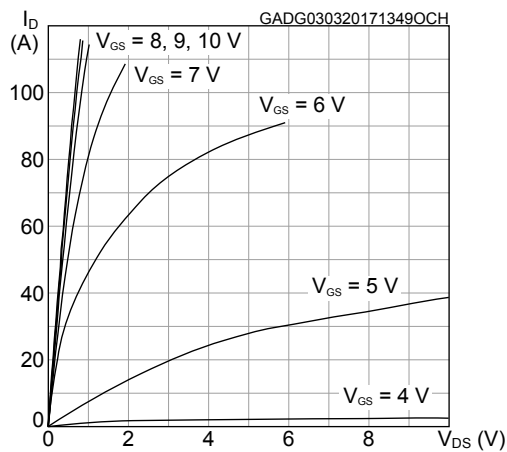
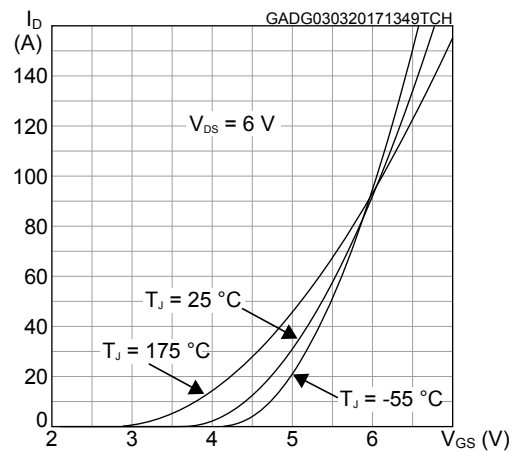
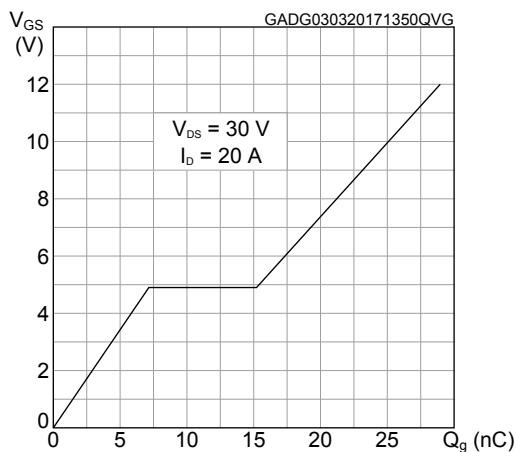
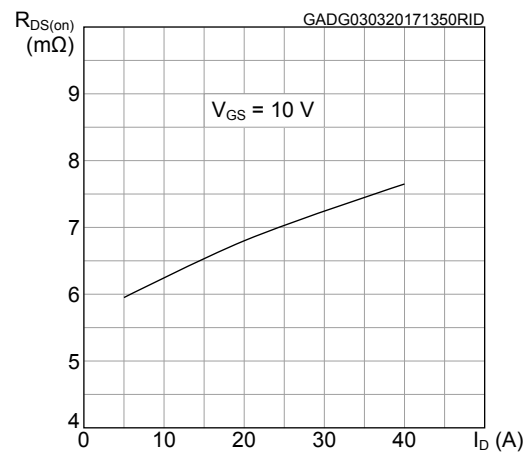
**Figure 1. Safe operating area**

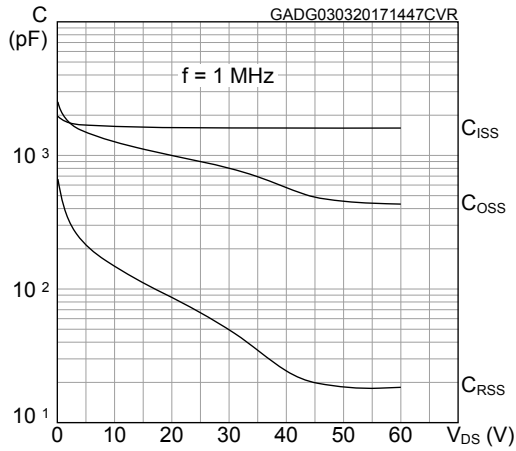
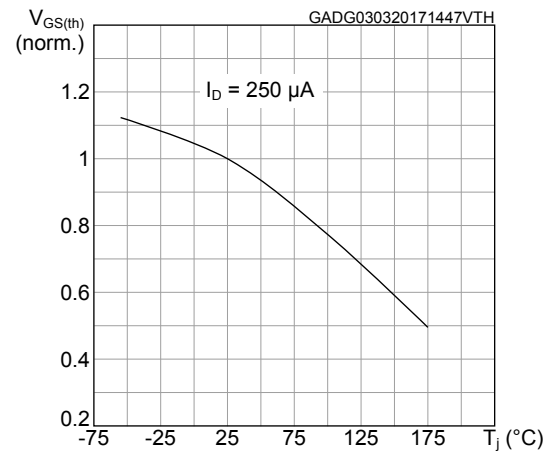
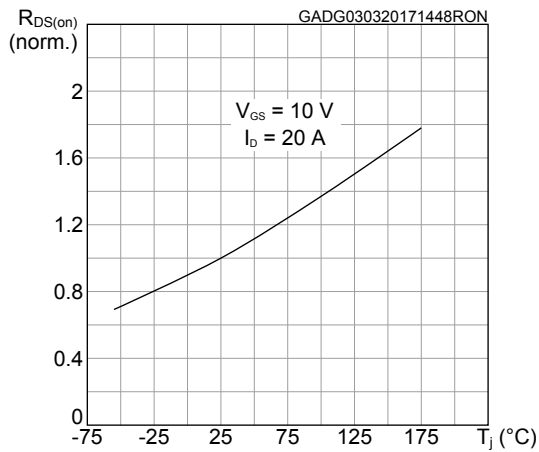
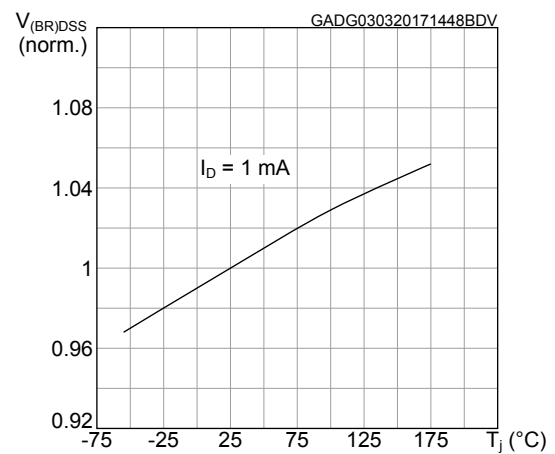
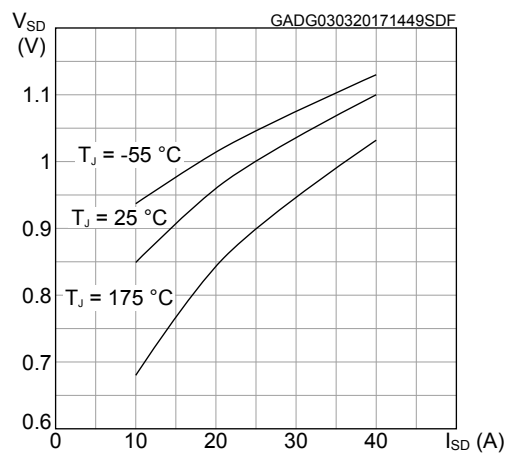
**Figure 2. Normalized thermal impedance**

**Figure 3. Output characteristics**

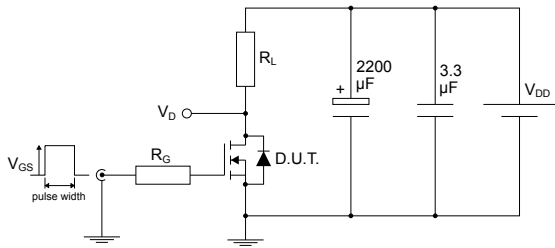
**Figure 4. Transfer characteristics**

**Figure 5. Gate charge vs gate-source voltage**

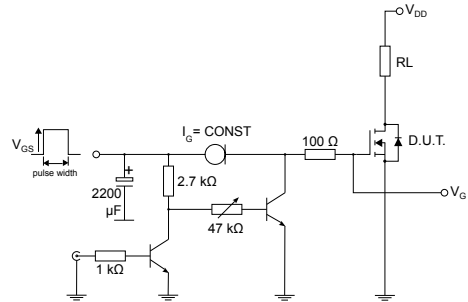
**Figure 6. Static drain-source on-resistance**

**Figure 7. Capacitance variations**

**Figure 8. Normalized  $V_{GS(th)}$  vs temperature**

**Figure 9. Normalized on-resistance vs temperature**

**Figure 10. Normalized  $V_{(BR)DSS}$  vs temperature**

**Figure 11. Source-drain diode forward characteristics**

### 3 Test circuits

**Figure 12. Test circuit for resistive load switching times**

AM01468v1

**Figure 13. Test circuit for gate charge behavior**

AM01469v10

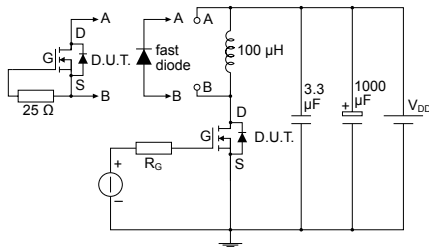
**Figure 14. Test circuit for inductive load switching and diode recovery times**

AM01470v1

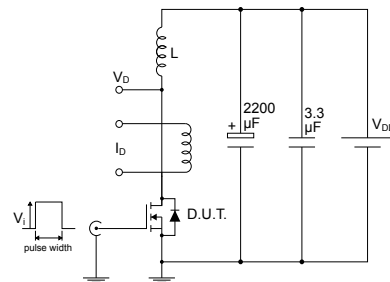
**Figure 15. Unclamped inductive load test circuit**

AM01471v1

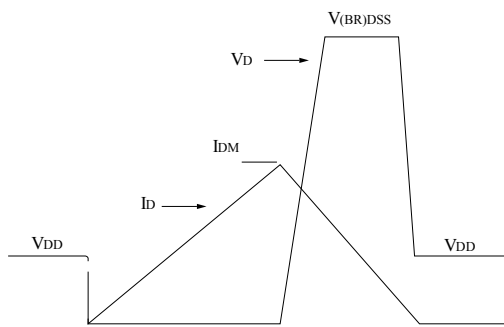
**Figure 16. Unclamped inductive waveform**

AM01472v1

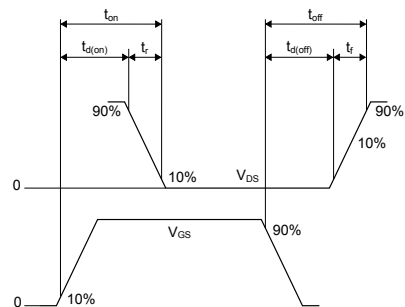
**Figure 17. Switching time waveform**

AM01473v1

## 4 Package information

---

In order to meet environmental requirements, ST offers these devices in different grades of ECOPACK® packages, depending on their level of environmental compliance. ECOPACK® specifications, grade definitions and product status are available at: [www.st.com](http://www.st.com). ECOPACK® is an ST trademark.

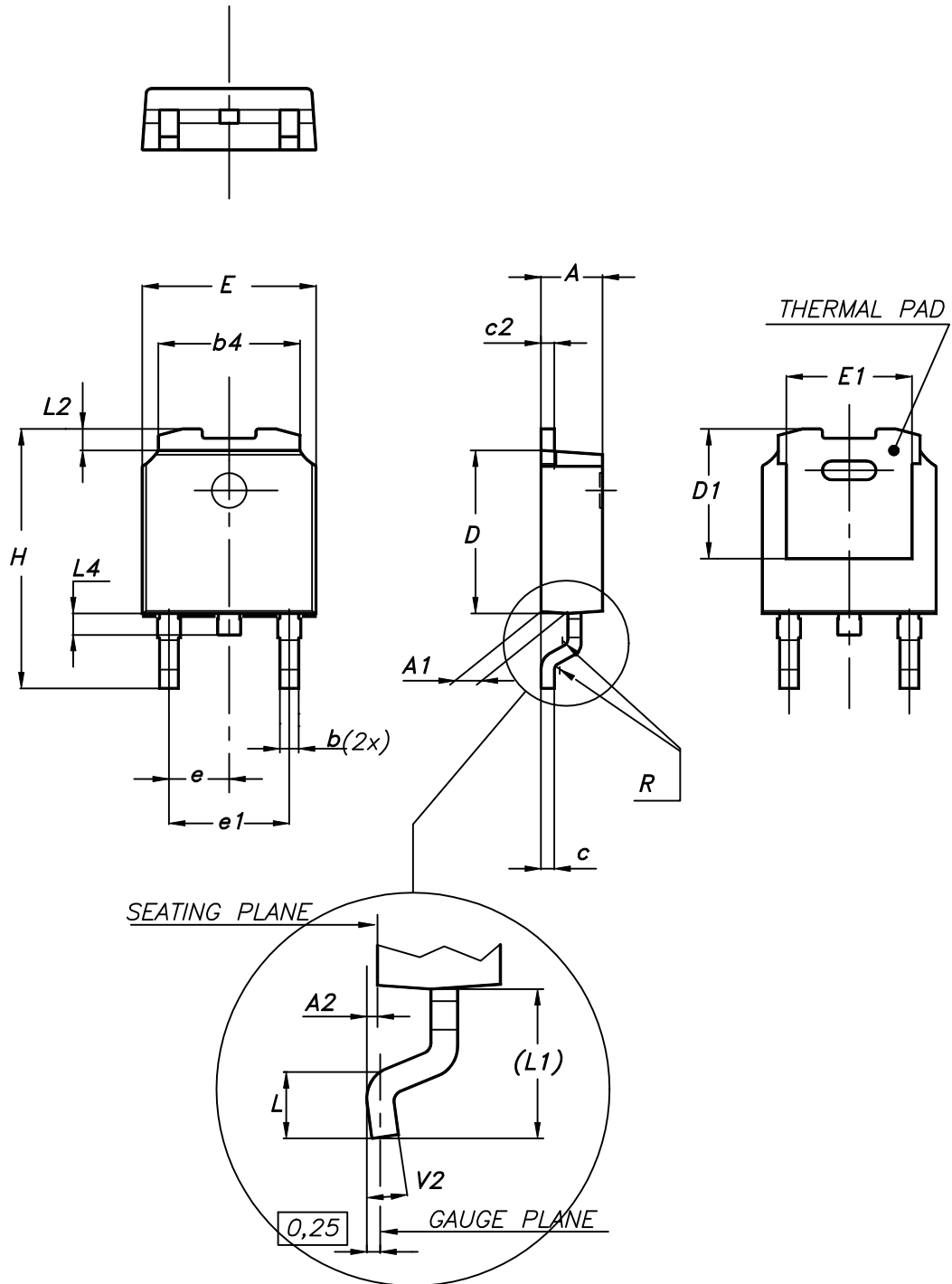
**4.1 DPAK (TO-252) type A2 package information**
**Figure 18. DPAK (TO-252) type A2 package outline**

0068772\_type-A2\_rev24

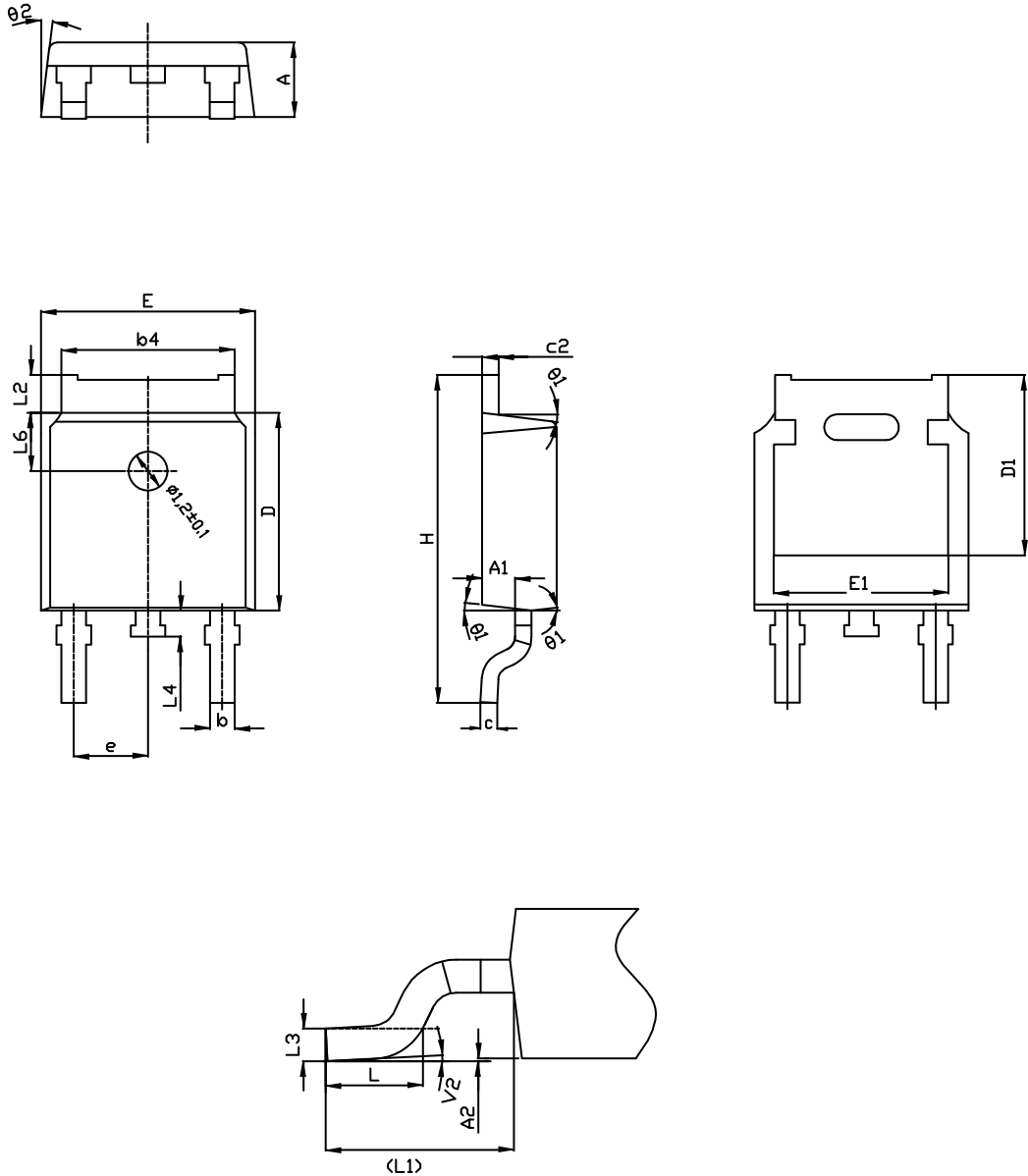

**Table 7. DPAK (TO-252) type A2 mechanical data**

Dim.	mm		
	Min.	Typ.	Max.
A	2.20		2.40
A1	0.90		1.10
A2	0.03		0.23
b	0.64		0.90
b4	5.20		5.40
c	0.45		0.60
c2	0.48		0.60
D	6.00		6.20
D1	4.95	5.10	5.25
E	6.40		6.60
E1	5.10	5.20	5.30
e	2.16	2.28	2.40
e1	4.40		4.60
H	9.35		10.10
L	1.00		1.50
L1	2.60	2.80	3.00
L2	0.65	0.80	0.95
L4	0.60		1.00
R		0.20	
V2	0°		8°

## 4.2 DPAK (TO-252) type C2 package information

Figure 19. DPAK (TO-252) type C2 package outline



0068772\_C2\_24

Table 8. DPAK (TO-252) type C2 mechanical data

Dim.	mm		
	Min.	Typ.	Max.
A	2.20	2.30	2.38
A1	0.90	1.01	1.10
A2	0.00		0.10
b	0.72		0.85
b4	5.13	5.33	5.46

Dim.	mm		
	Min.	Typ.	Max.
c	0.47		0.60
c2	0.47		0.60
D	6.00	6.10	6.20
D1	5.10		5.60
E	6.50	6.60	6.70
E1	5.20		5.50
e	2.186	2.286	2.386
H	9.80	10.10	10.40
L	1.40	1.50	1.70
L1	2.90 REF		
L2	0.90		1.25
L3	0.51 BSC		
L4	0.60	0.80	1.00
L6	1.80 BSC		
θ1	5°	7°	9°
θ2	5°	7°	9°
V2	0°		8°

### 4.3 DPAK (TO-252) footprint information

Figure 20. DPAK (TO-252) recommended footprint (dimensions are in mm)

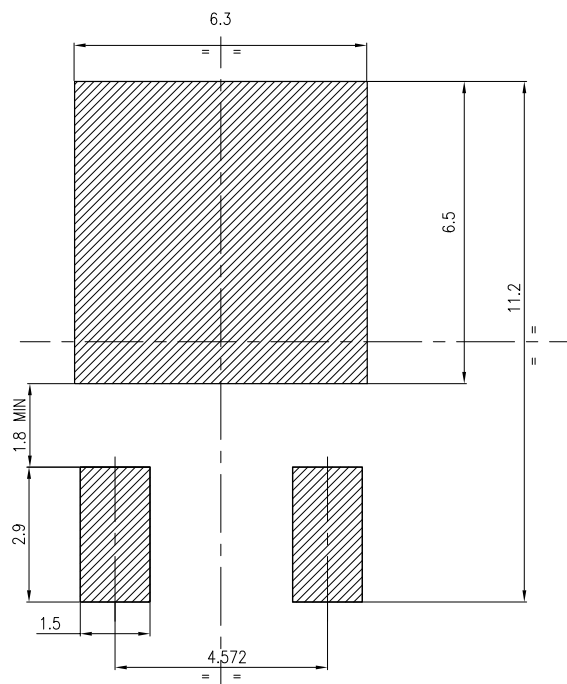

FP\_0068772\_24

## Revision history

**Table 9. Document revision history**

Date	Revision	Changes
03-Nov-2016	1	First release
03-Mar-2017	2	Updated <i>Table 2: "Absolute maximum ratings"</i> and <i>Table 5: "Dynamic"</i> . Added Section 2.1: " <i>Electrical characteristics (curves)</i> ". Minor text changes.
02-May-2017	3	Updated <i>Table 2: "Absolute maximum ratings"</i> .
01-Feb-2018	4	Added DPAK (TO-252) type C package information. Removed maturity status indication from cover page.
12-Feb-2018	5	Modified <a href="#">Section 4 Package information</a> . Minor text changes.

## Contents

<b>1</b>	<b>Electrical ratings</b> .....	<b>2</b>
<b>2</b>	<b>Electrical characteristics</b> .....	<b>3</b>
<b>2.1</b>	Electrical characteristics (curves).....	<b>4</b>
<b>3</b>	<b>Test circuits</b> .....	<b>6</b>
<b>4</b>	<b>Package information</b> .....	<b>7</b>
<b>4.1</b>	DPAK (TO-252) type A2 package information .....	<b>7</b>
<b>4.2</b>	DPAK (TO-252) type C2 package information .....	<b>9</b>
<b>4.3</b>	DPAK (TO-252) footprint information.....	<b>11</b>
	<b>Revision history</b> .....	<b>12</b>
	<b>Contents</b> .....	<b>13</b>
	<b>Disclaimer</b> .....	<b>14</b>

**IMPORTANT NOTICE – PLEASE READ CAREFULLY**

STMicroelectronics NV and its subsidiaries (“ST”) reserve the right to make changes, corrections, enhancements, modifications, and improvements to ST products and/or to this document at any time without notice. Purchasers should obtain the latest relevant information on ST products before placing orders. ST products are sold pursuant to ST’s terms and conditions of sale in place at the time of order acknowledgement.

Purchasers are solely responsible for the choice, selection, and use of ST products and ST assumes no liability for application assistance or the design of Purchasers’ products.

No license, express or implied, to any intellectual property right is granted by ST herein.

Resale of ST products with provisions different from the information set forth herein shall void any warranty granted by ST for such product.

ST and the ST logo are trademarks of ST. All other product or service names are the property of their respective owners.

Information in this document supersedes and replaces information previously supplied in any prior versions of this document.

© 2018 STMicroelectronics – All rights reserved