

ON Semiconductor

Is Now

onsemi™

To learn more about onsemi™, please visit our website at
www.onsemi.com

onsemi and **onsemi** and other names, marks, and brands are registered and/or common law trademarks of Semiconductor Components Industries, LLC dba "**onsemi**" or its affiliates and/or subsidiaries in the United States and/or other countries. **onsemi** owns the rights to a number of patents, trademarks, copyrights, trade secrets, and other intellectual property. A listing of **onsemi** product/patent coverage may be accessed at www.onsemi.com/site/pdf/Patent-Marking.pdf. **onsemi** reserves the right to make changes at any time to any products or information herein, without notice. The information herein is provided "as-is" and **onsemi** makes no warranty, representation or guarantee regarding the accuracy of the information, product features, availability, functionality, or suitability of its products for any particular purpose, nor does **onsemi** assume any liability arising out of the application or use of any product or circuit, and specifically disclaims any and all liability, including without limitation special, consequential or incidental damages. Buyer is responsible for its products and applications using **onsemi** products, including compliance with all laws, regulations and safety requirements or standards, regardless of any support or applications information provided by **onsemi**. "Typical" parameters which may be provided in **onsemi** data sheets and/or specifications can and do vary in different applications and actual performance may vary over time. All operating parameters, including "Typicals" must be validated for each customer application by customer's technical experts. **onsemi** does not convey any license under any of its intellectual property rights nor the rights of others. **onsemi** products are not designed, intended, or authorized for use as a critical component in life support systems or any FDA Class 3 medical devices or medical devices with a same or similar classification in a foreign jurisdiction or any devices intended for implantation in the human body. Should Buyer purchase or use **onsemi** products for any such unintended or unauthorized application, Buyer shall indemnify and hold **onsemi** and its officers, employees, subsidiaries, affiliates, and distributors harmless against all claims, costs, damages, and expenses, and reasonable attorney fees arising out of, directly or indirectly, any claim of personal injury or death associated with such unintended or unauthorized use, even if such claim alleges that **onsemi** was negligent regarding the design or manufacture of the part. **onsemi** is an Equal Opportunity/Affirmative Action Employer. This literature is subject to all applicable copyright laws and is not for resale in any manner. Other names and brands may be claimed as the property of others.

MCH3333A

MOSFET – Power, Single P-Channel -30 V, 215 mΩ, -2.0 A

This Power MOSFET is produced using ON Semiconductor's trench technology, which is specifically designed to minimize gate charge and low on resistance. This device is suitable for applications with low gate charge driving or low on resistance requirements.

Features

- Low On-Resistance
- 1.8V drive
- ESD Diode-Protected Gate
- Pb-Free, Halogen Free and RoHS compliance

Typical Applications

- Load Switch

SPECIFICATIONS

ABSOLUTE MAXIMUM RATING at $T_a = 25^\circ\text{C}$ (Note 1)

Parameter	Symbol	Value	Unit
Drain to Source Voltage	V_{DSS}	-30	V
Gate to Source Voltage	V_{GSS}	± 10	V
Drain Current (DC)	I_D	-2.0	A
Drain Current (Pulse) $PW \leq 10\mu\text{s}$, duty cycle $\leq 1\%$	I_{DP}	-8.0	A
Power Dissipation When mounted on ceramic substrate (1000mm ² × 0.8mm)	P_D	0.9	W
Junction Temperature	T_j	150	°C
Storage Temperature	T_{stg}	-55 to +150	°C

Note 1 : Stresses exceeding those listed in the Maximum Ratings table may damage the device. If any of these limits are exceeded, device functionality should not be assumed, damage may occur and reliability may be affected.

THERMAL RESISTANCE RATINGS

Parameter	Symbol	Value	Unit
Junction to Ambient When mounted on ceramic substrate (1000mm ² × 0.8mm)	$R_{\theta JA}$	138.8	°C/W



ON Semiconductor[®]

www.onsemi.com

V_{DSS}	$R_{DS(on)}$ Max	I_D Max
-30V	215mΩ@ -4V	-2A
	280mΩ@ -2.5V	
	430mΩ@ -1.8V	

ELECTRICAL CONNECTION P-Channel

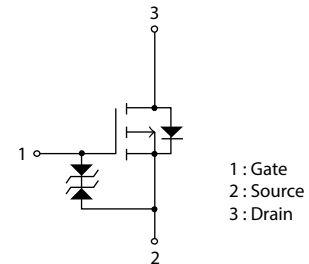

PACKING TYPE : TL

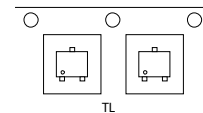

MARKING

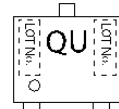

ORDERING INFORMATION

See detailed ordering and shipping information on page 5 of this data sheet.

ELECTRICAL CHARACTERISTICS at Ta = 25°C (Note 2)

Parameter	Symbol	Conditions	Value			Unit
			min	typ	max	
Drain to Source Breakdown Voltage	V(BR)DSS	ID=-1mA, VGS=0V	-30			V
Zero-Gate Voltage Drain Current	IDSS	VDS=-30V, VGS=0V			-1	μA
Gate to Source Leakage Current	IGSS	VGS=±8V, VDS=0V			±10	μA
Gate Threshold Voltage	VGS(th)	VDS=-10V, ID=-1mA	-0.4		-1.3	V
Forward Transconductance	gFS	VDS=-10V, ID=-1.0A		2.5		S
Static Drain to Source On-State Resistance	RDS(on)1	ID=-1.0A, VGS=-4V		165	215	mΩ
	RDS(on)2	ID=-0.5A, VGS=-2.5V		200	280	mΩ
	RDS(on)3	ID=-0.2A, VGS=-1.8V		270	430	mΩ
Input Capacitance	Ciss	VDS=-10V, f=1MHz		240		pF
Output Capacitance	Coss			39		pF
Reverse Transfer Capacitance	Crss			31		pF
Turn-ON Delay Time	t _{d(on)}		See specified Test Circuit		5.7	
Rise Time	t _r			9.7		ns
Turn-OFF Delay Time	t _{d(off)}			27		ns
Fall Time	t _f			16		ns
Total Gate Charge	Qg	VDS=-15V, VGS=-4V, ID=-2.0A			2.8	
Gate to Source Charge	Qgs			0.3		nC
Gate to Drain "Miller" Charge	Qgd			0.95		nC
Forward Diode Voltage	VSD	IS=-2.0A, VGS=0V		-0.87	-1.5	V

Note 2 : Product parametric performance is indicated in the Electrical Characteristics for the listed test conditions, unless otherwise noted. Product performance may not be indicated by the Electrical Characteristics if operated under different conditions.

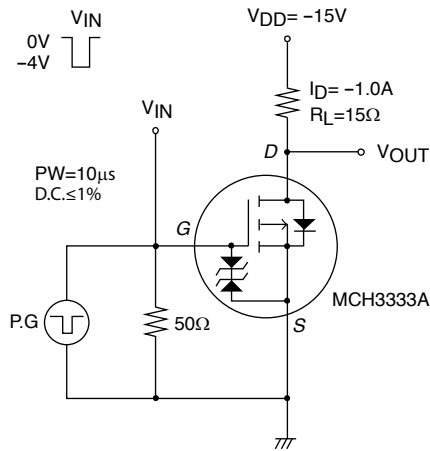
Switching Time Test Circuit

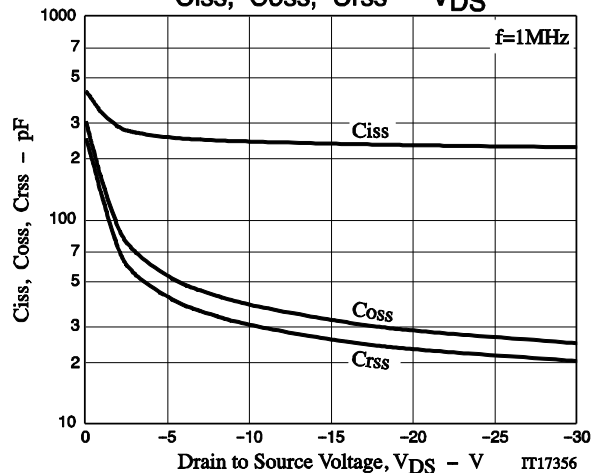
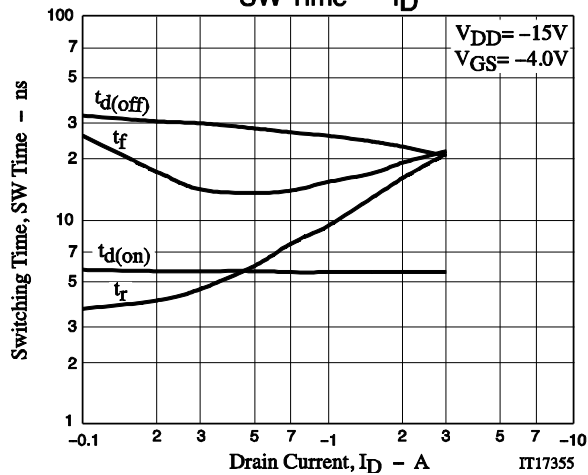
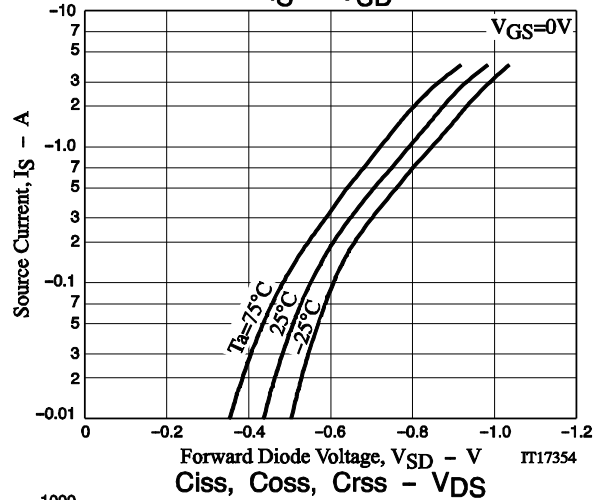
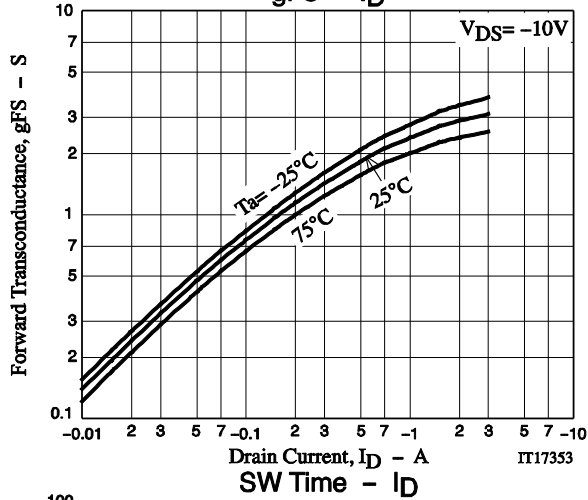
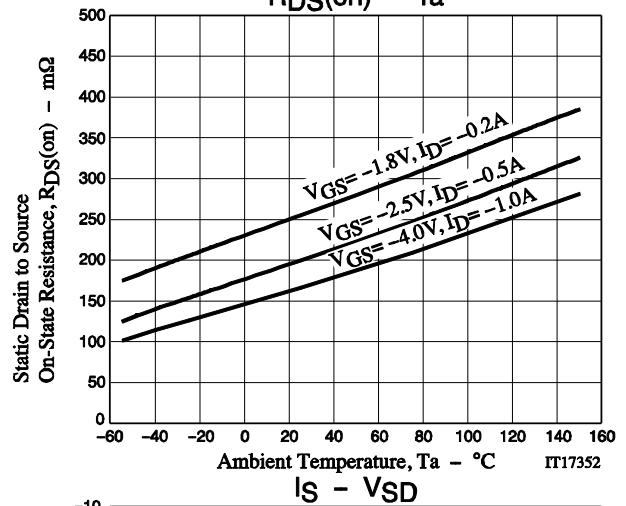
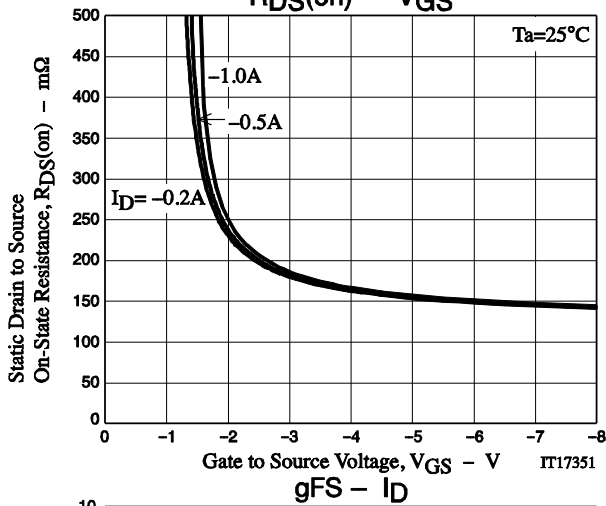
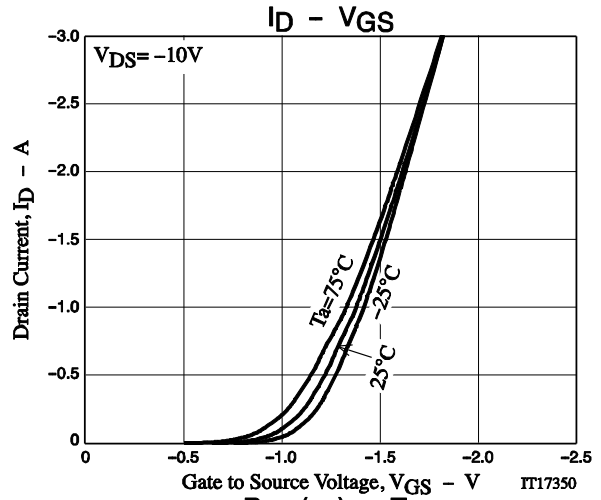
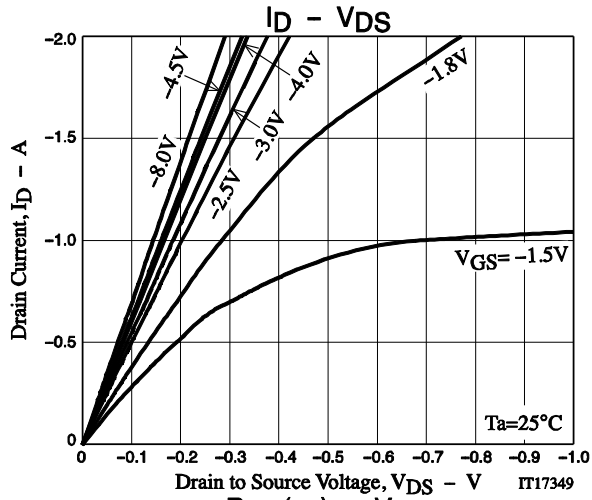

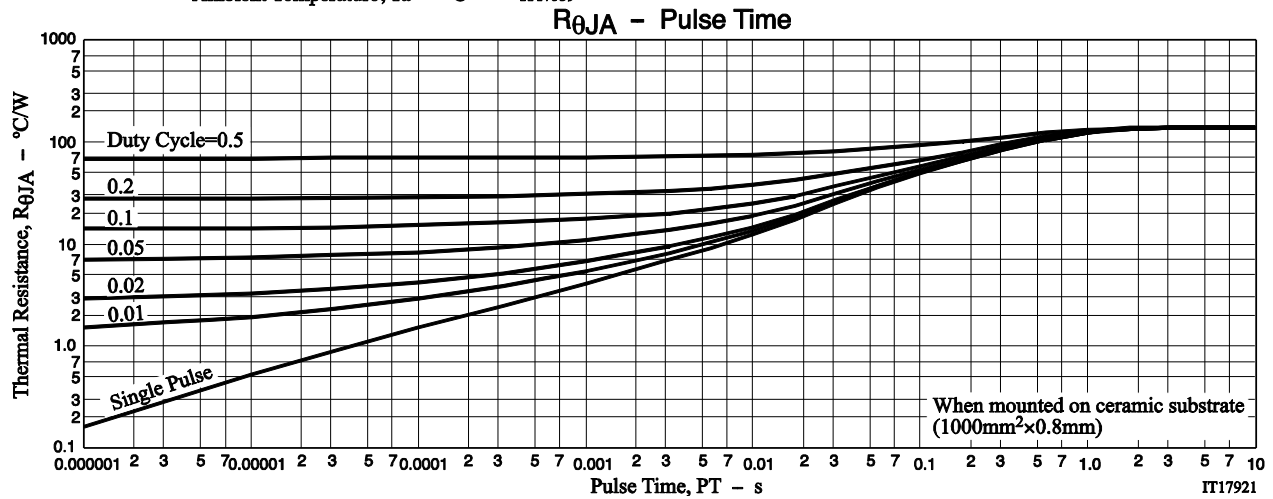
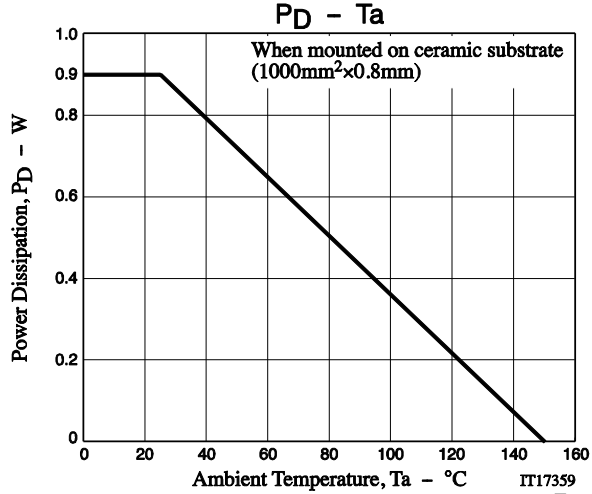
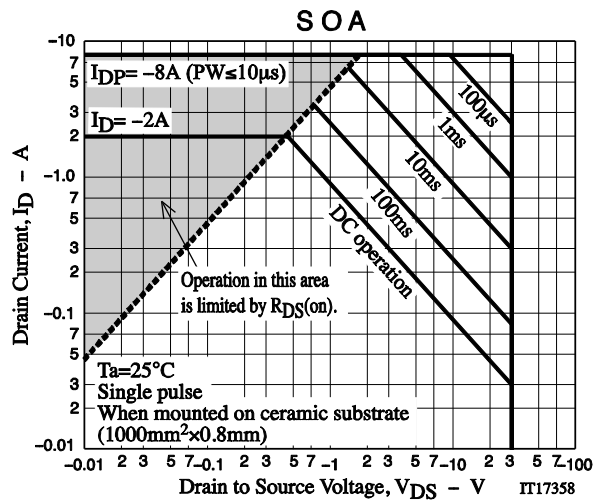
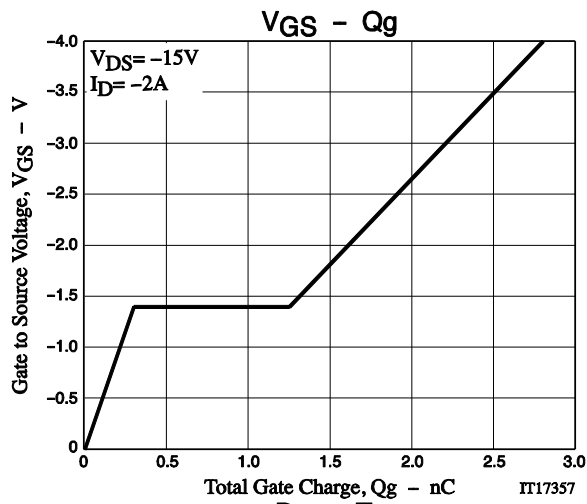

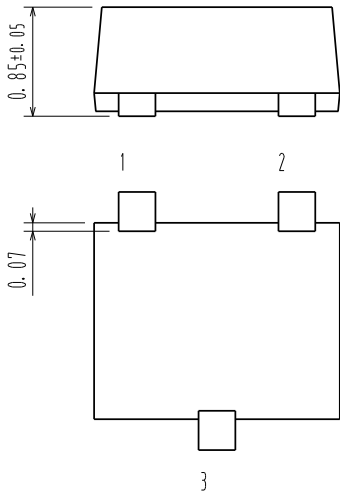
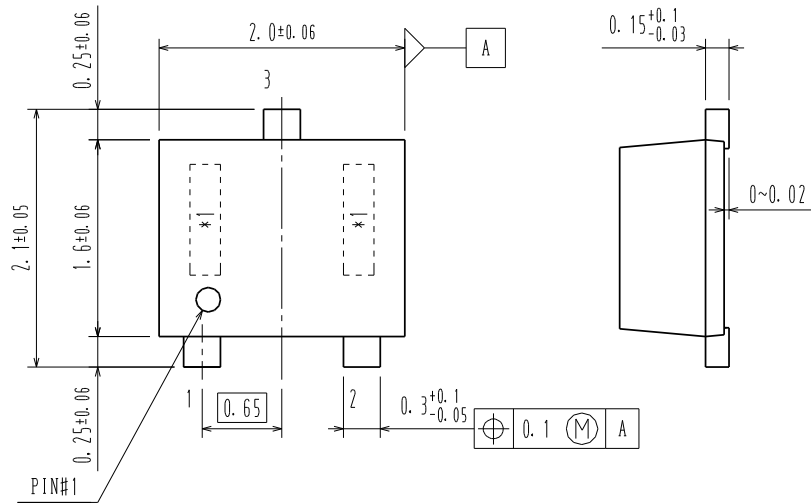

*1: Lot indication

- 1 : Gate
- 2 : Source
- 3 : Drain

Recommended Soldering Footprint

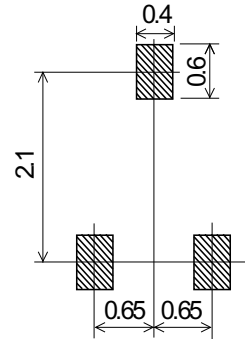

ORDERING INFORMATION

Device	Marking	Package	Shipping (Qty / Packing)
MCH3333A-TL-H	QU	SC-70FL / MCPH3 (Pb-Free / Halogen Free)	3,000 / Tape & Reel
MCH3333A-TL-W			

† For information on tape and reel specifications, including part orientation and tape sizes, please refer to our Tape and Reel Packaging Specifications Brochure, BRD8011/D. http://www.onsemi.com/pub_link/Collateral/BRD8011-D.PDF

Note on usage : Since the MCH3333A is a MOSFET product, please avoid using this device in the vicinity of highly charged objects.

ON Semiconductor and the ON logo are registered trademarks of Semiconductor Components Industries, LLC (SCILLC) or its subsidiaries in the United States and/or other countries. SCILLC owns the rights to a number of patents, trademarks, copyrights, trade secrets, and other intellectual property. A listing of SCILLC's product/patent coverage may be accessed at www.onsemi.com/site/pdf/Patent-Marking.pdf. SCILLC reserves the right to make changes without further notice to any products herein. SCILLC makes no warranty, representation or guarantee regarding the suitability of its products for any particular purpose, nor does SCILLC assume any liability arising out of the application or use of any product or circuit, and specifically disclaims any and all liability, including without limitation special, consequential or incidental damages. "Typical" parameters which may be provided in SCILLC data sheets and/or specifications can and do vary in different applications and actual performance may vary over time. All operating parameters, including "Typicals" must be validated for each customer application by customer's technical experts. SCILLC does not convey any license under its patent rights nor the rights of others. SCILLC products are not designed, intended, or authorized for use as components in systems intended for surgical implant into the body, or other applications intended to support or sustain life, or for any other application in which the failure of the SCILLC product could create a situation where personal injury or death may occur. Should Buyer purchase or use SCILLC products for any such unintended or unauthorized application, Buyer shall indemnify and hold SCILLC and its officers, employees, subsidiaries, affiliates, and distributors harmless against all claims, costs, damages, and expenses, and reasonable attorney fees arising out of, directly or indirectly, any claim of personal injury or death associated with such unintended or unauthorized use, even if such claim alleges that SCILLC was negligent regarding the design or manufacture of the part. SCILLC is an Equal Opportunity/Affirmative Action Employer. This literature is subject to all applicable copyright laws and is not for resale in any manner.