

## Silicon carbide Power MOSFET 650 V, 18 mΩ typ., 40 A in a PowerFLAT 8x8 HV package

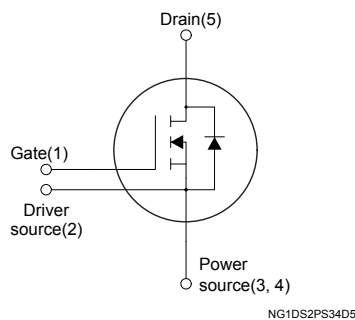
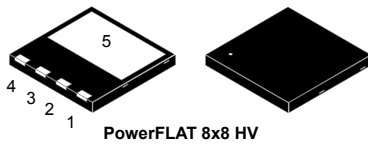

### Features

Order code	V <sub>DS</sub>	R <sub>DS(on)</sub> max.	I <sub>D</sub>
SCTL90N65G2V	650 V	24 mΩ	40 A

- Very fast and robust intrinsic body diode
- Low capacitances
- Source sensing pin for increased efficiency

### Applications

- Switching mode power supply
- DC-DC converters
- Industrial motor control

### Description

This silicon carbide Power MOSFET device has been developed using ST's advanced and innovative 2<sup>nd</sup> generation SiC MOSFET technology. The device features remarkably low on-resistance per unit area and very good switching performance. The variation of switching loss is almost independent of junction temperature.



#### Product status link

[SCTL90N65G2V](#)

#### Product summary

<b>Order code</b>	SCTL90N65G2V
<b>Marking</b>	90N65G2V
<b>Package</b>	PowerFLAT 8x8 HV
<b>Packing</b>	Tape and reel

# 1 Electrical ratings

**Table 1. Absolute maximum ratings**

Symbol	Parameter	Value	Unit
$V_{DS}$	Drain-source voltage	650	V
$V_{GS}$	Gate-source voltage	-10 to 22	V
	Gate-source voltage (recommended operating values)	-5 to 18	
$I_D^{(1)}$	Drain current (continuous) at $T_C = 25\text{ °C}$	40	A
	Drain current (continuous) at $T_C = 100\text{ °C}$	40	
$I_{DM}^{(2)}$	Drain current (pulsed)	160	A
$P_{TOT}$	Total power dissipation at $T_C = 25\text{ °C}$	935	W
$T_{stg}$	Storage temperature range	-55 to 175	°C
$T_J$	Operating junction temperature range		°C

1. Value limited by package.
2. Pulse width is limited by safe operating area.

**Table 2. Thermal data**

Symbol	Parameter	Value	Unit
$R_{thJC}$	Thermal resistance, junction-to-case	0.16	°C/W
$R_{thJB}^{(1)}$	Thermal resistance, junction-to-board	45	°C/W

1. When mounted on an 1-inch<sup>2</sup> FR-4, 2 Oz copper board.

## 2 Electrical characteristics

( $T_C = 25\text{ °C}$  unless otherwise specified).

**Table 3. On/off states**

Symbol	Parameter	Test conditions	Min.	Typ.	Max.	Unit
$V_{(BR)DSS}$	Drain-source breakdown voltage	$V_{GS} = 0\text{ V}$ , $I_D = 1\text{ mA}$	650			V
$I_{DSS}$	Zero gate voltage drain current	$V_{DS} = 650\text{ V}$ , $V_{GS} = 0\text{ V}$			10	$\mu\text{A}$
$I_{GSS}$	Gate-body leakage current	$V_{DS} = 0\text{ V}$ , $V_{GS} = -10\text{ to }22\text{ V}$			$\pm 100$	nA
$V_{GS(th)}$	Gate threshold voltage	$V_{DS} = V_{GS}$ , $I_D = 1\text{ mA}$	1.8	3.2	5.0	V
$R_{DS(on)}$	Static drain-source on-resistance	$V_{GS} = 18\text{ V}$ , $I_D = 40\text{ A}$		18	24	m $\Omega$
		$V_{GS} = 18\text{ V}$ , $I_D = 40\text{ A}$ , $T_J = 175\text{ °C}$		27		

**Table 4. Dynamic, based on HiP247 package option**

Symbol	Parameter	Test conditions	Min.	Typ.	Max.	Unit
$C_{iss}$	Input capacitance	$V_{DS} = 400\text{ V}$ , $f = 1\text{ MHz}$ , $V_{GS} = 0\text{ V}$	-	3380	-	pF
$C_{oss}$	Output capacitance		-	294	-	pF
$C_{rss}$	Reverse transfer capacitance		-	49	-	pF
$R_g$	Gate input resistance	$f = 1\text{ MHz}$ , $I_D = 0\text{ A}$	-	1	-	$\Omega$
$Q_g$	Total gate charge	$V_{DD} = 400\text{ V}$ , $I_D = 50\text{ A}$ , $V_{GS} = -5\text{ V to }18\text{ V}$	-	157	-	nC
$Q_{gs}$	Gate-source charge		-	43	-	nC
$Q_{gd}$	Gate-drain charge		-	42	-	nC

**Table 5. Switching energy (inductive load), based on HiP247 package option**

Symbol	Parameter	Test conditions	Min.	Typ.	Max.	Unit
$E_{on}$	Turn-on switching energy	$V_{GS} = -5\text{ to }18\text{ V}$ , $V_{DD} = 400\text{ V}$ , $I_D = 50\text{ A}$ , $R_G = 2.2\text{ }\Omega$	-	130	-	$\mu\text{J}$
$E_{off}$	Turn-off switching energy		-	210	-	$\mu\text{J}$
$E_{on}$	Turn-on switching energy	$V_{GS} = -5\text{ to }18\text{ V}$ , $V_{DD} = 400\text{ V}$ , $I_D = 50\text{ A}$ , $R_G = 2.2\text{ }\Omega$ , $T_C = 150\text{ °C}$	-	135	-	$\mu\text{J}$
$E_{off}$	Turn-off switching energy		-	200	-	$\mu\text{J}$

**Table 6. Switching times, based on HiP247 package option**

Symbol	Parameter	Test conditions	Min.	Typ.	Max.	Unit
$t_{d(on)}$	Turn-on delay time	$V_{DD} = 400\text{ V}$ , $I_D = 50\text{ A}$ , $R_G = 2.2\text{ }\Omega$ , $V_{GS} = -5\text{ V to }18\text{ V}$	-	26	-	ns
$t_f$	Fall time		-	16	-	ns
$t_{d(off)}$	Turn-off delay time		-	58	-	ns
$t_r$	Rise time		-	38	-	ns

**Table 7. Reverse SiC diode characteristics, based on HiP247 package option**

Symbol	Parameter	Test conditions	Min.	Typ.	Max.	Unit
$V_{SD}$	Forward on voltage	$I_F = 30\text{ A}$ , $V_{GS} = 0\text{ V}$	-	2.5	-	V
$t_{rr}$	Reverse recovery time	$I_F = 50\text{ A}$ , $di/dt = 4000\text{ A}/\mu\text{s}$ , $V_{DD} = 400\text{ V}$	-	17	-	ns
$Q_{rr}$	Reverse recovery charge		-	308	-	nC
$I_{RRM}$	Reverse recovery current		-	30	-	A

## 2.1 Electrical characteristics (curves)

**Figure 1. Safe operating area**

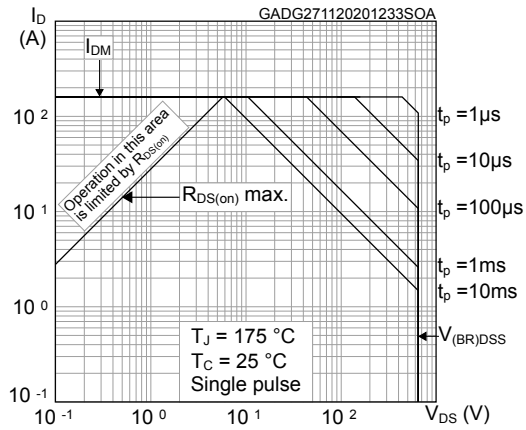

**Figure 2. Maximum transient thermal impedance**

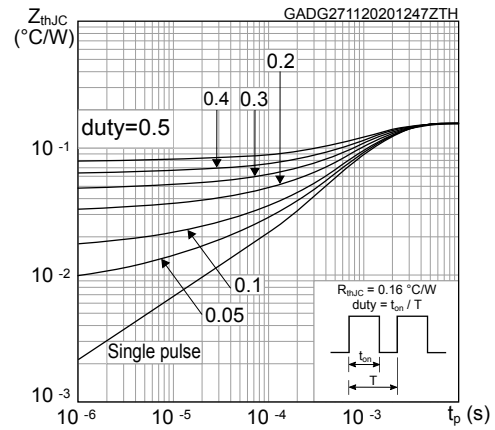

**Figure 3. Typical output characteristics (T<sub>J</sub> = -50 °C)**

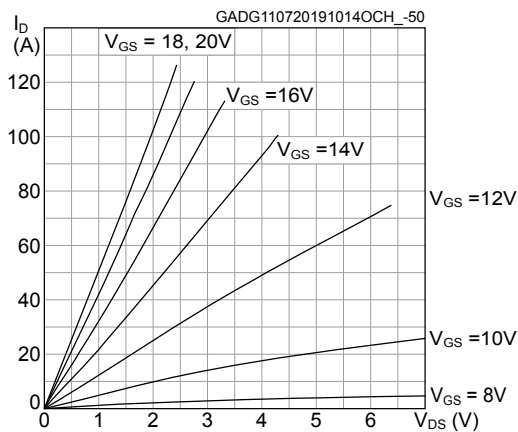

**Figure 4. Typical output characteristics (T<sub>J</sub> = 25 °C)**

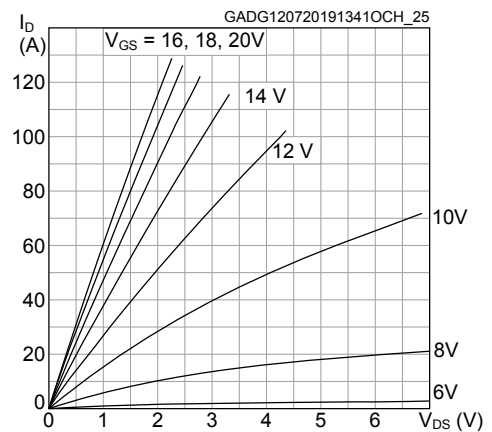

**Figure 5. Typical output characteristics (T<sub>J</sub> = 175 °C)**

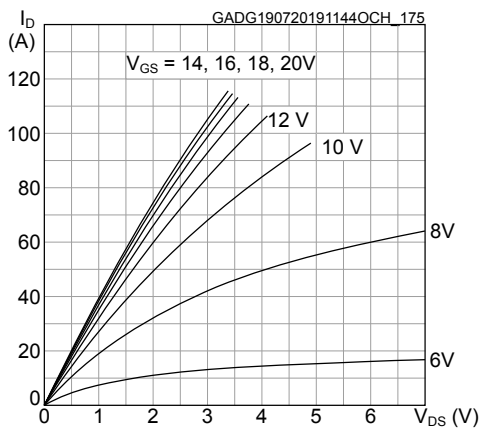

**Figure 6. Typical transfer characteristics**

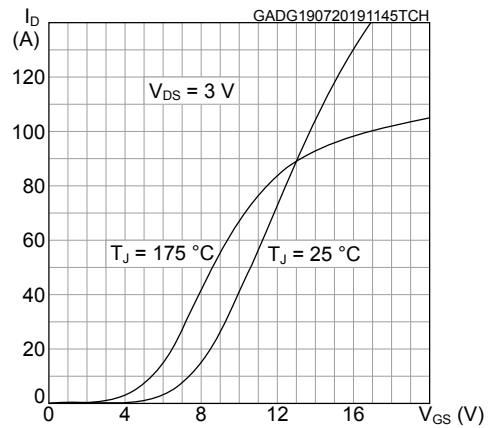

**Figure 7. Typical capacitance characteristics, based on HiP247 package option**

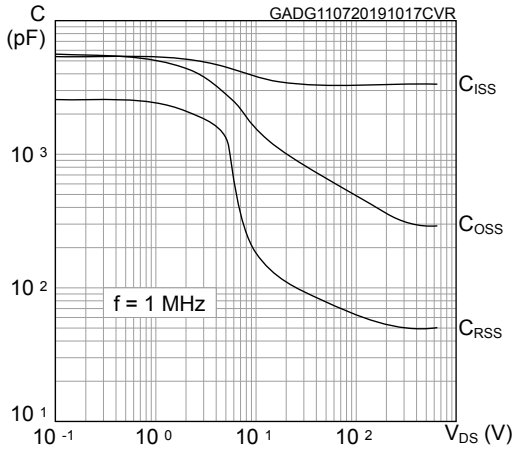

**Figure 8. Typical gate charge characteristics, based on HiP247 package option**

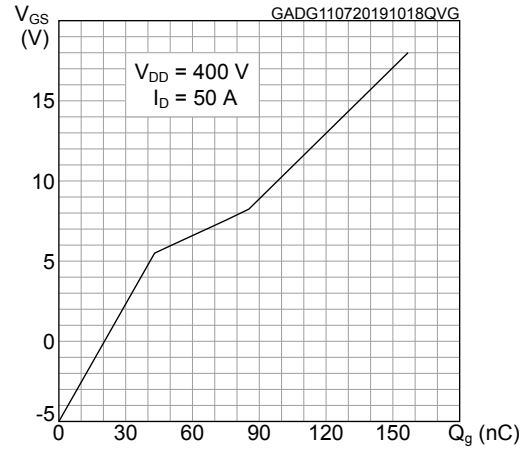

**Figure 9. Total power dissipation**

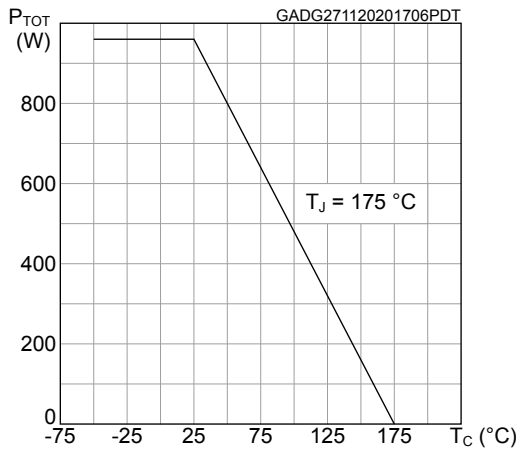

**Figure 10. Normalized on-resistance vs temperature**

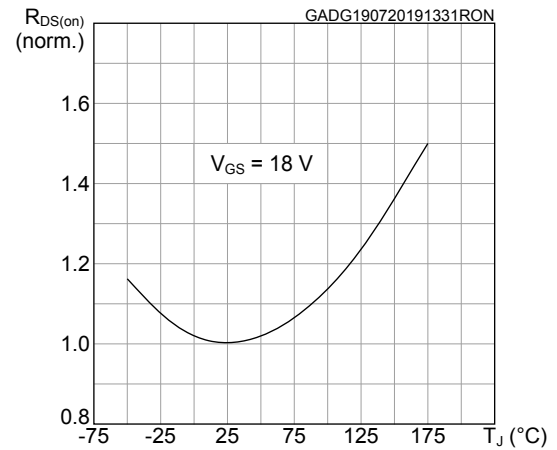

**Figure 11. Normalized gate threshold vs temperature**

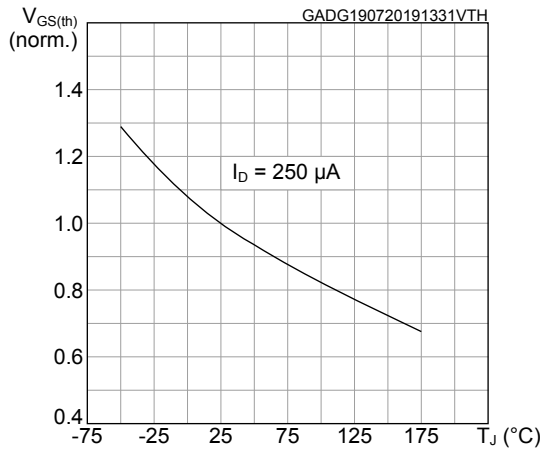

**Figure 12. Normalized breakdown voltage vs temperature**

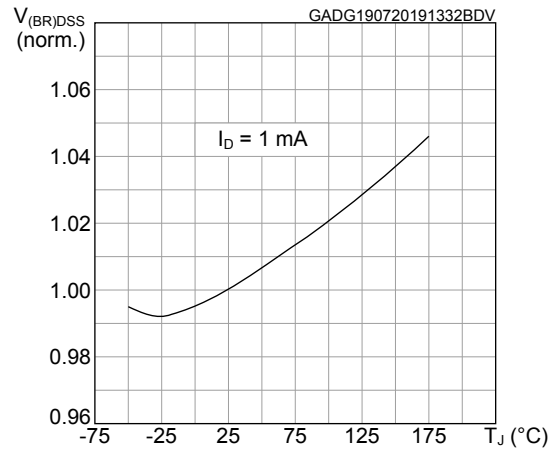

**Figure 13. Typical switching energy vs drain current, based on HiP247 package option**

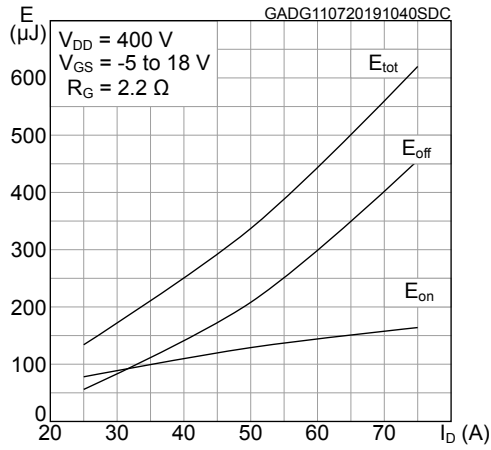

**Figure 14. Typical switching energy vs temperature**

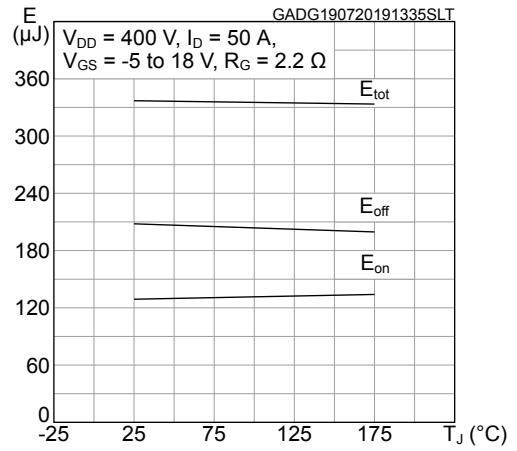

**Figure 15. Typical reverse conduction characteristics (T<sub>J</sub> = -50 °C)**

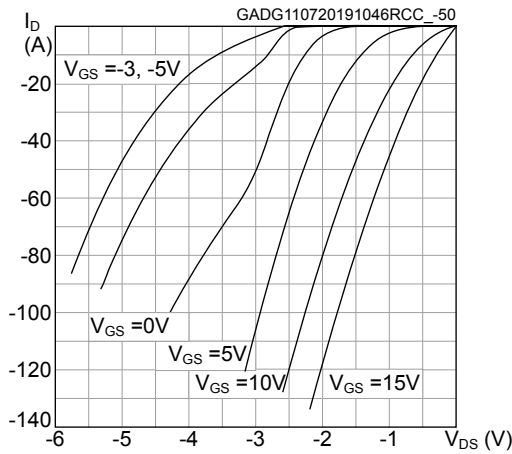

**Figure 16. Typical reverse conduction characteristics (T<sub>J</sub> = 25 °C)**

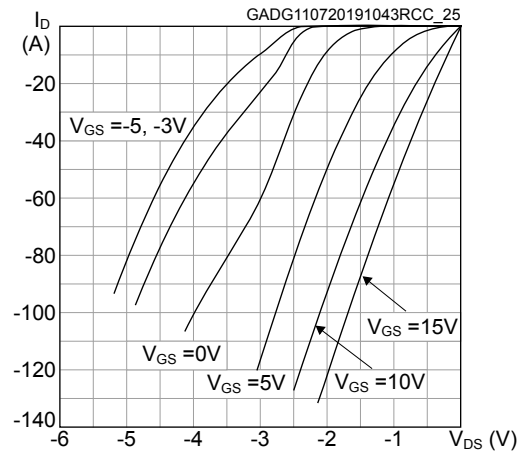

**Figure 17. Typical reverse conduction characteristics (T<sub>J</sub> = 150 °C)**

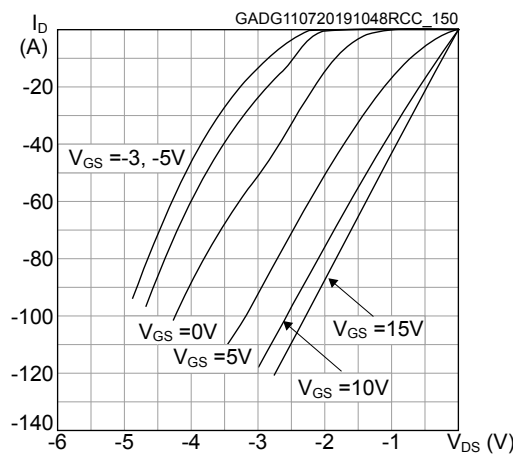

### 3 Package information

In order to meet environmental requirements, ST offers these devices in different grades of **ECOPACK** packages, depending on their level of environmental compliance. ECOPACK specifications, grade definitions and product status are available at: [www.st.com](http://www.st.com). ECOPACK is an ST trademark.

#### 3.1 PowerFLAT 8x8 HV type A package information

**Figure 18. PowerFLAT 8x8 HV type A package outline**

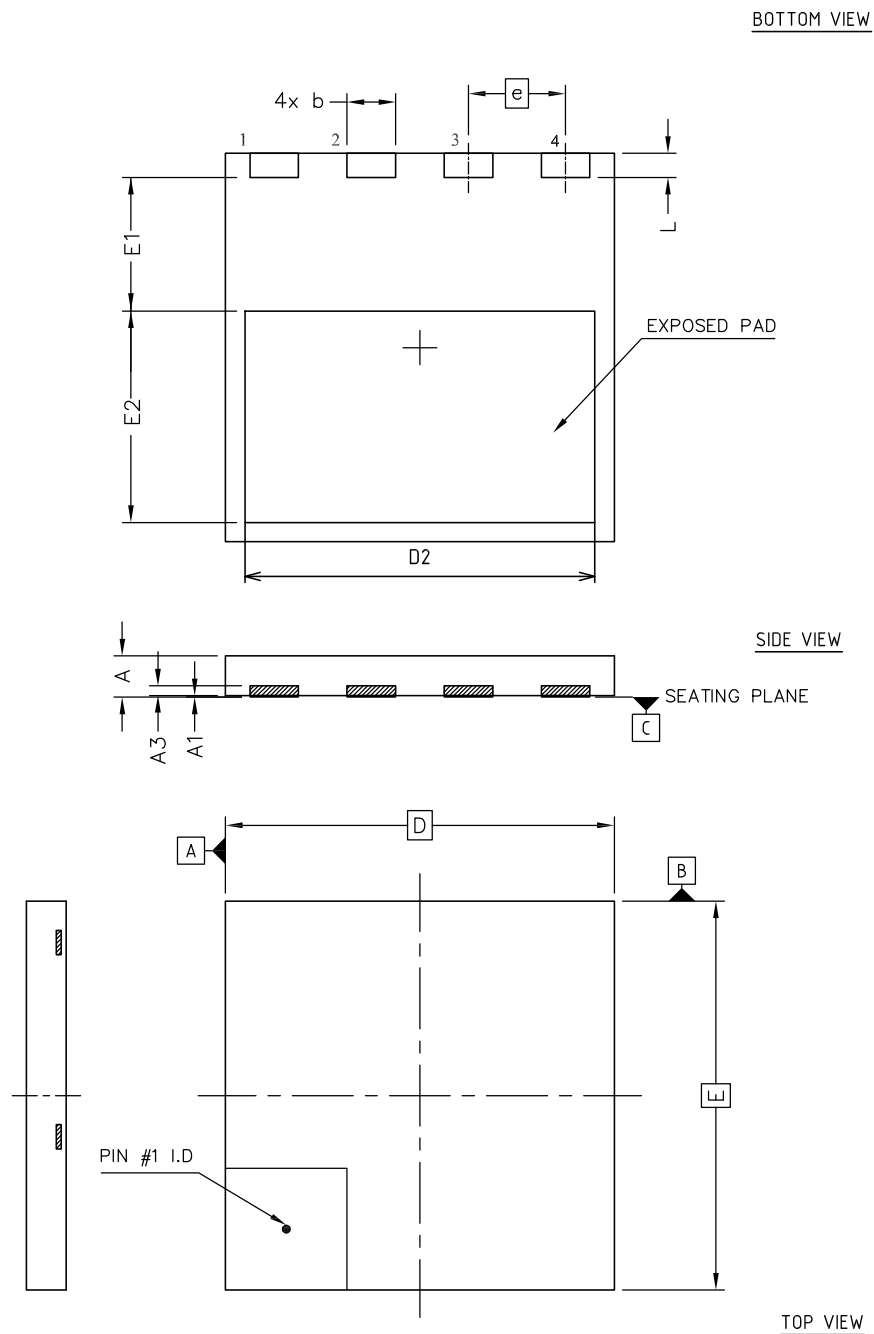

8222871\_Rev\_4



**Table 8. PowerFLAT 8x8 HV type A mechanical data**

Ref.	Dimensions (in mm)		
	Min.	Typ.	Max.
A	0.75	0.85	0.95
A1	0.00		0.05
A3	0.10	0.20	0.30
b	0.90	1.00	1.10
D	7.90	8.00	8.10
E	7.90	8.00	8.10
D2	7.10	7.20	7.30
E1	2.65	2.75	2.85
E2	4.25	4.35	4.45
e	2.00 BSC		
L	0.40	0.50	0.60

**Figure 19. PowerFLAT 8x8 HV footprint**

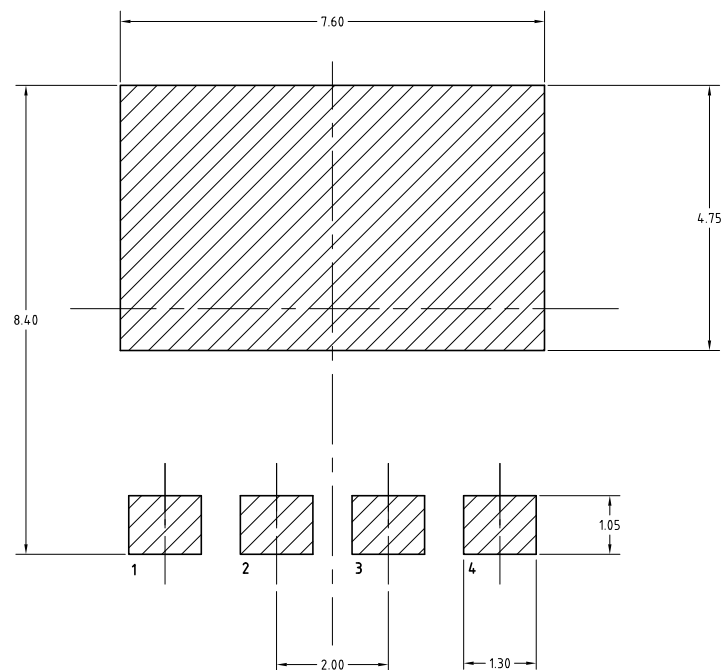

8222871\_REV\_4\_footprint

*Note:* All dimensions are in millimeters.

### 3.2 PowerFLAT 8x8 HV packing information

Figure 20. PowerFLAT 8x8 HV tape

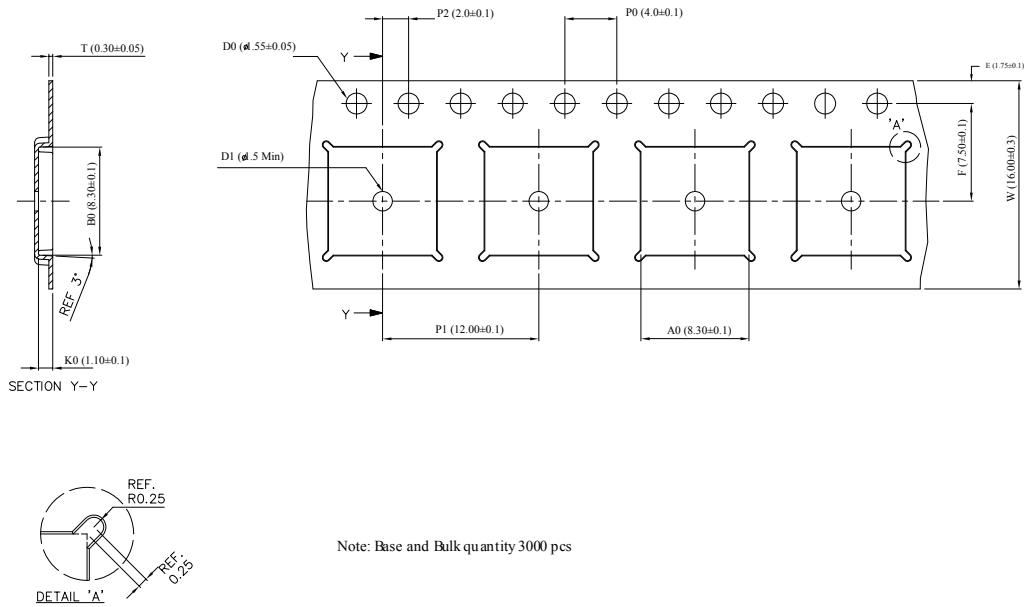

8229819\_Tape\_revA

Note: All dimensions are in millimeters.

Figure 21. PowerFLAT 8x8 HV package orientation in carrier tape

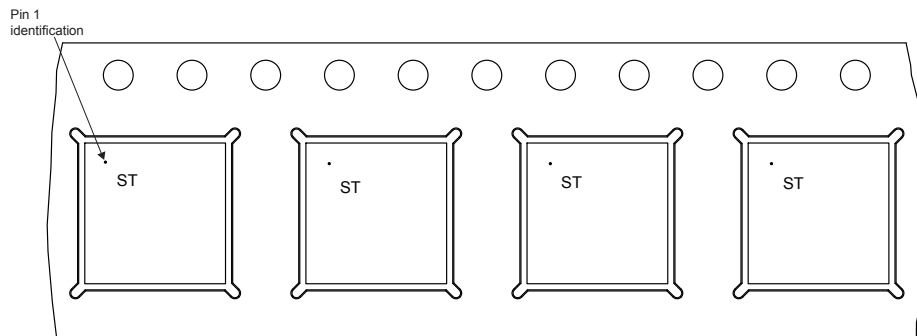



## Revision history

**Table 9. Document revision history**

Date	Version	Changes
10-Dec-2020	1	First release.

---

## Contents

<b>1</b>	<b>Electrical ratings</b> .....	<b>2</b>
<b>2</b>	<b>Electrical characteristics</b> .....	<b>3</b>
<b>2.1</b>	Electrical characteristics (curves) .....	<b>5</b>
<b>3</b>	<b>Package information</b> .....	<b>8</b>
<b>3.1</b>	PowerFLAT 8x8 HV type A package information .....	<b>8</b>
<b>3.2</b>	PowerFLAT 8x8 HV packing information .....	<b>10</b>
	<b>Revision history</b> .....	<b>12</b>

**IMPORTANT NOTICE – PLEASE READ CAREFULLY**

STMicroelectronics NV and its subsidiaries (“ST”) reserve the right to make changes, corrections, enhancements, modifications, and improvements to ST products and/or to this document at any time without notice. Purchasers should obtain the latest relevant information on ST products before placing orders. ST products are sold pursuant to ST’s terms and conditions of sale in place at the time of order acknowledgement.

Purchasers are solely responsible for the choice, selection, and use of ST products and ST assumes no liability for application assistance or the design of Purchasers’ products.

No license, express or implied, to any intellectual property right is granted by ST herein.

Resale of ST products with provisions different from the information set forth herein shall void any warranty granted by ST for such product.

ST and the ST logo are trademarks of ST. For additional information about ST trademarks, please refer to [www.st.com/trademarks](http://www.st.com/trademarks). All other product or service names are the property of their respective owners.

Information in this document supersedes and replaces information previously supplied in any prior versions of this document.

© 2020 STMicroelectronics – All rights reserved