

# 1PMT5920B Series

## 3.2 Watt Plastic Surface Mount POWERMITE® Package

This complete new line of 3.2 Watt Zener Diodes are offered in highly efficient micro miniature, space saving surface mount with its unique heat sink design. The POWERMITE package has the same thermal performance as the SMA while being 50% smaller in footprint area and delivering one of the lowest height profiles (1.1 mm) in the industry. Because of its small size, it is ideal for use in cellular phones, portable devices, business machines and many other industrial/consumer applications.

### Features

- Zener Breakdown Voltage: 6.2 – 47 V
- DC Power Dissipation: 3.2 W with Tab 1 (Cathode) @ 75°C
- Low Leakage < 5  $\mu$ A
- ESD Rating of Class 3 (> 16 kV) per Human Body Model
- Low Profile – Maximum Height of 1.1 mm
- Integral Heat Sink/Locking Tabs
- Full Metallic Bottom Eliminates Flux Entrapment
- Small Footprint – Footprint Area of 8.45 mm<sup>2</sup>
- Supplied in 12 mm Tape and Reel
  - T1 = 3,000 Units per Reel
  - T3 = 12,000 Units per Reel
- Lead Orientation in Tape: Cathode (Short) Lead to Sprocket Holes
- POWERMITE is JEDEC Registered as DO-216AA
- Cathode Indicated by Polarity Band
- Pb-Free Packages are Available

### Mechanical Characteristics

**CASE:** Void-free, transfer-molded, thermosetting plastic

**FINISH:** All external surfaces are corrosion resistant and leads are readily solderable

**MOUNTING POSITION:** Any

**MAXIMUM CASE TEMPERATURE FOR SOLDERING PURPOSES:**  
260°C for 10 Seconds



**ON Semiconductor®**

<http://onsemi.com>

## PLASTIC SURFACE MOUNT 3.2 WATT ZENER DIODES 6.2 – 47 VOLTS

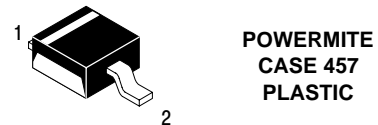
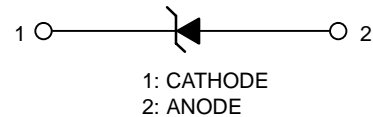

### MARKING DIAGRAM

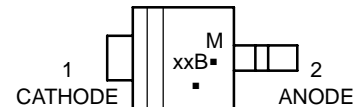

- M = Date Code
- xxB = Specific Device Code (See Table on Page 2)
- = Pb-Free Package

### ORDERING INFORMATION

Device	Package	Shipping†
1PMT59xxBT1	POWERMITE	3,000/Tape&Reel
1PMT59xxBT1G	POWERMITE (Pb-Free)	3,000/Tape&Reel
1PMT59xxBT3	POWERMITE	12,000/Tape&Reel
1PMT59xxBT3G	POWERMITE (Pb-Free)	12,000/Tape&Reel

Individual devices are listed on page 2 of this data sheet.

†For information on tape and reel specifications, including part orientation and tape sizes, please refer to our Tape and Reel Packaging Specifications Brochure, BRD8011/D.

# 1PMT5920B Series

## MAXIMUM RATINGS

Rating	Symbol	Value	Unit
DC Power Dissipation @ $T_A = 25^\circ\text{C}$ (Note 1) Derate above $25^\circ\text{C}$	$P_D$	500	mW
Thermal Resistance, Junction-to-Ambient	$R_{\theta JA}$	4.0	$\text{mW}/^\circ\text{C}$
Thermal Resistance, Junction-to-Lead (Anode)	$R_{\theta J\text{anode}}$	248	$^\circ\text{C}/\text{W}$
Maximum DC Power Dissipation (Note 2) Thermal Resistance from Junction-to-Tab (Cathode)	$P_D$ $R_{\theta J\text{cathode}}$	3.2 23	W $^\circ\text{C}/\text{W}$
Operating and Storage Temperature Range	$T_J, T_{\text{stg}}$	-55 to +150	$^\circ\text{C}$

Maximum ratings are those values beyond which device damage can occur. Maximum ratings applied to the device are individual stress limit values (not normal operating conditions) and are not valid simultaneously. If these limits are exceeded, device functional operation is not implied, damage may occur and reliability may be affected.

- Mounted with recommended minimum pad size, PC board FR-4.
- At Tab (Cathode) temperature,  $T_{\text{tab}} = 75^\circ\text{C}$

**ELECTRICAL CHARACTERISTICS** ( $T_L = 25^\circ\text{C}$  unless otherwise noted,  $V_F = 1.5\text{ V}$  Max. @  $I_F = 200\text{ mA}$ dc for all types)

Symbol	Parameter
$V_Z$	Reverse Zener Voltage @ $I_{ZT}$
$I_{ZT}$	Reverse Current
$Z_{ZT}$	Maximum Zener Impedance @ $I_{ZT}$
$I_{ZK}$	Reverse Current
$Z_{ZK}$	Maximum Zener Impedance @ $I_{ZK}$
$I_R$	Reverse Leakage Current @ $V_R$
$V_R$	Reverse Voltage
$I_F$	Forward Current
$V_F$	Forward Voltage @ $I_F$

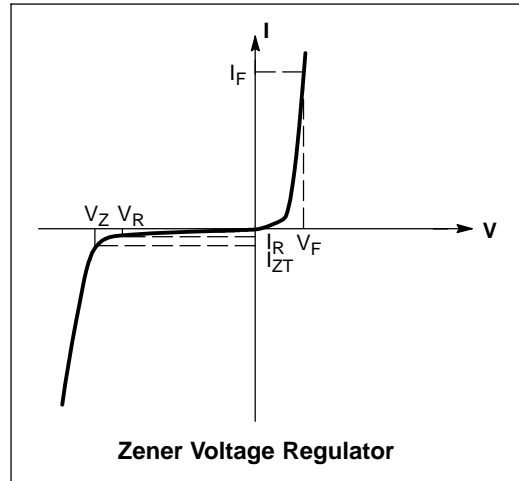

**ELECTRICAL CHARACTERISTICS** ( $T_L = 30^\circ\text{C}$  unless otherwise noted,  $V_F = 1.25\text{ Volts}$  @  $200\text{ mA}$ )

Device*	Device Marking	Zener Voltage (Note 3)			$I_{ZT}$ (mA)	$I_R$ @ $V_R$ ( $\mu\text{A}$ )	$V_R$ (V)	$Z_{ZT}$ @ $I_{ZT}$ (Note 4) ( $\Omega$ )	$Z_{ZK}$ @ $I_{ZK}$ (Note 4) ( $\Omega$ )	$I_{ZK}$ (mA)
		$V_Z$ @ $I_{ZT}$ (Volts)								
		Min	Nom	Max						
1PMT5920BT1, T3,G	20B	5.89	6.2	6.51	60.5	5.0	4.0	2.0	200	1.0
1PMT5921BT1, T3,G	21B	6.46	6.8	7.14	55.1	5.0	5.2	2.5	200	1.0
1PMT5922BT1, T3,G	22B	7.12	7.5	7.88	50	5.0	6.0	3.0	400	0.5
1PMT5923BT1, T3,G	23B	7.79	8.2	8.61	45.7	5.0	6.5	3.5	400	0.5
1PMT5924BT1, T3,G	24B	8.64	9.1	9.56	41.2	5.0	7.0	4.0	500	0.5
1PMT5925BT1, T3,G	25B	9.5	10	10.5	37.5	5.0	8.0	4.5	500	0.25
1PMT5927BT1, T3,G	27B	11.4	12	12.6	31.2	1.0	9.1	6.5	550	0.25
1PMT5929BT1, T3,G	29B	14.25	15	15.75	25	1.0	11.4	9.0	600	0.25
1PMT5930BT1, T3,G	30B	15.2	16	16.8	23.4	1.0	12.2	10	600	0.25
1PMT5931BT1, T3,G	31B	17.1	18	18.9	20.8	1.0	13.7	12	650	0.25
1PMT5933BT1, T3,G	33B	20.9	22	23.1	17	1.0	16.7	17.5	650	0.25
1PMT5934BT1, T3,G	34B	22.8	24	25.2	15.6	1.0	18.2	19	700	0.25
1PMT5935BT1, T3,G	35B	25.65	27	28.35	13.9	1.0	20.6	23	700	0.25
1PMT5936BT1, T3,G	36B	28.5	30	31.5	12.5	1.0	22.8	28	750	0.25
1PMT5939BT1, T3,G	39B	37.05	39	40.95	9.6	1.0	29.7	45	900	0.25
1PMT5941BT1, T3,G	41B	44.65	47	49.35	8.0	1.0	35.8	67	1000	0.25

3. Zener voltage is measured with the device junction in thermal equilibrium with an ambient temperature of  $25^\circ\text{C}$ .

4. Zener Impedance Derivation  $Z_{ZT}$  and  $Z_{ZK}$  are measured by dividing the AC voltage drop across the device by the AC current applied. The specified limits are for  $I_Z(\text{ac}) = 0.1 I_Z(\text{dc})$  with the ac frequency = 60 Hz.

\* The "G" suffix indicates Pb-Free package available.

# 1PMT5920B Series

## TYPICAL CHARACTERISTICS

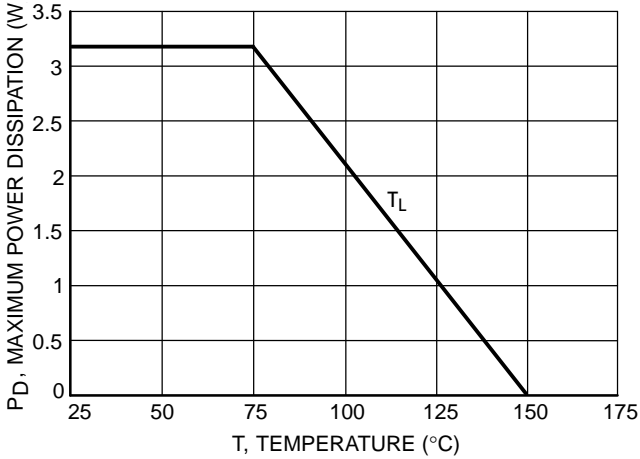

Figure 1. Steady State Power Derating

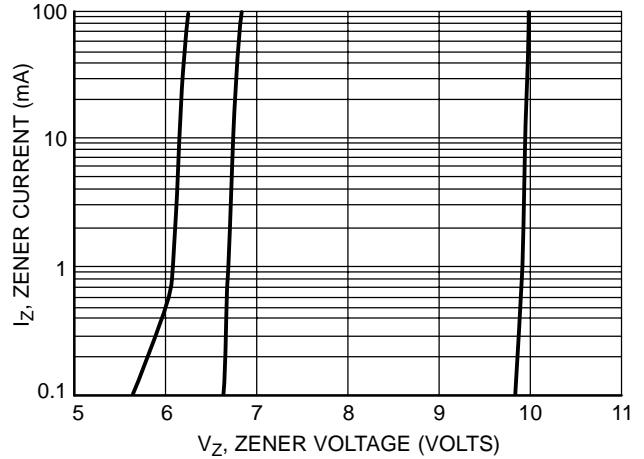

Figure 2.  $V_Z$  to 10 Volts

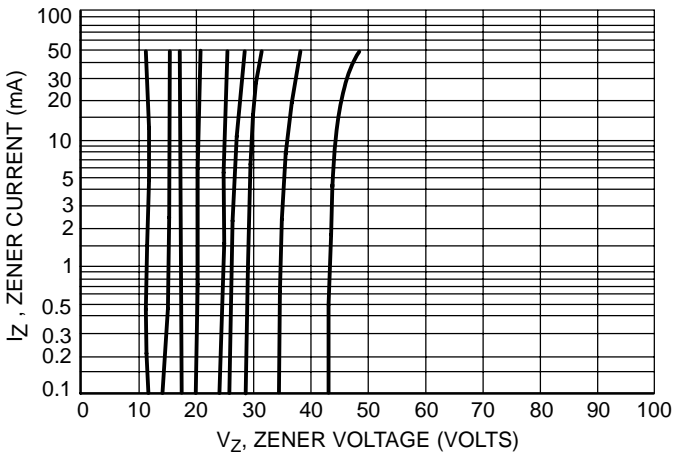

Figure 3.  $V_Z = 12$  thru 47 Volts

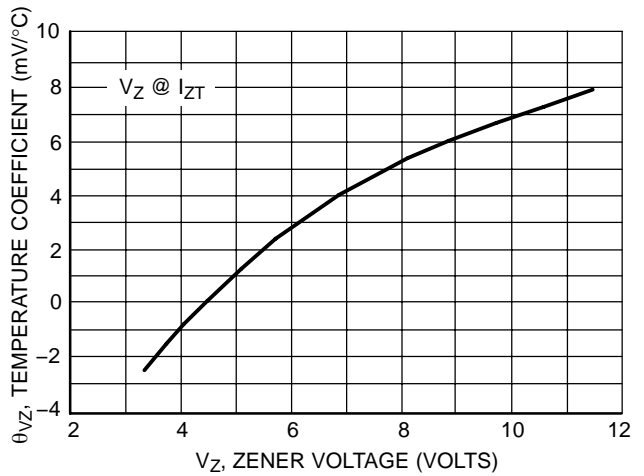

Figure 4. Zener Voltage - To 12 Volts

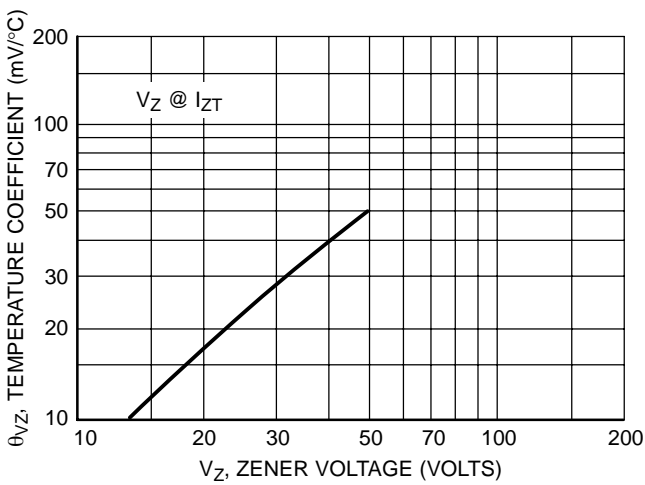

Figure 5. Zener Voltage - 14 To 47 Volts

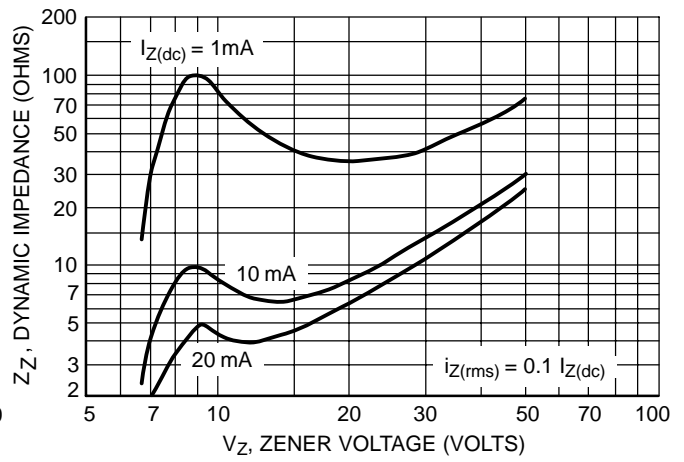

Figure 6. Effect of Zener Voltage

# 1PMT5920B Series

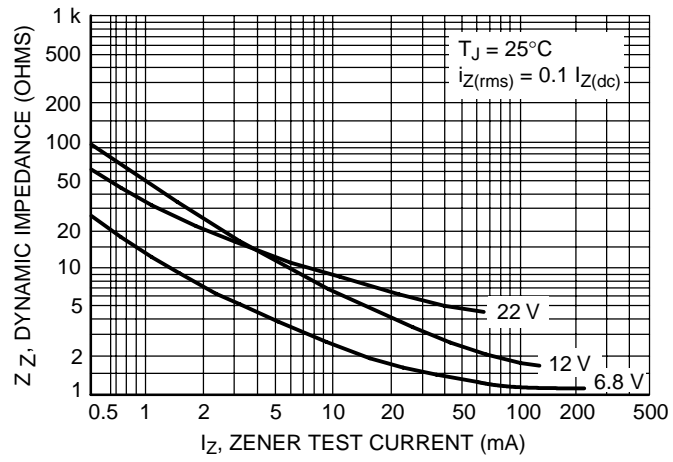

Figure 7. Effect of Zener Current

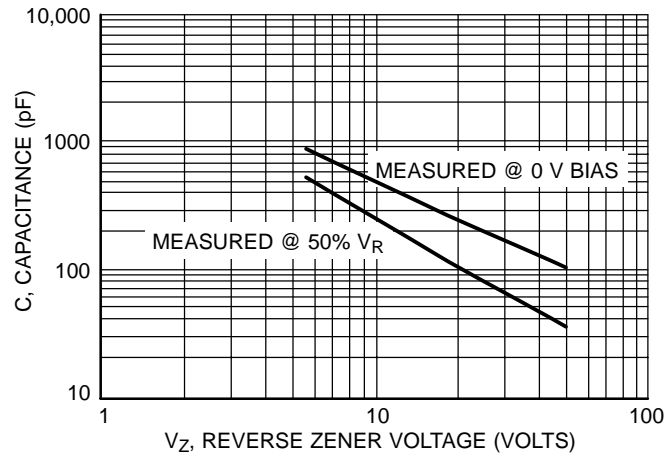
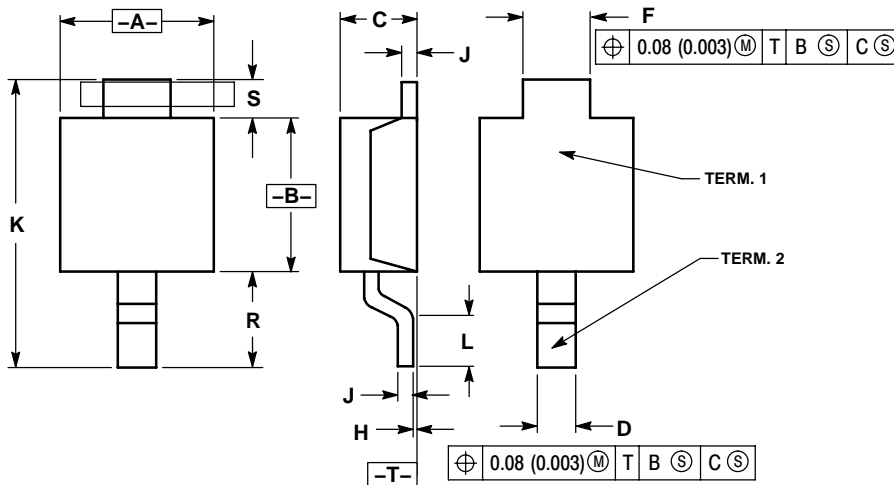

Figure 8. Capacitance versus Reverse Zener Voltage

# 1PMT5920B Series

## OUTLINE DIMENSIONS

POWERMITE®  
CASE 457-04  
ISSUE D



NOTES:

1. DIMENSIONING AND TOLERANCING PER ANSI Y14.5M, 1982.
2. CONTROLLING DIMENSION: MILLIMETER.
3. DIMENSION A DOES NOT INCLUDE MOLD FLASH, PROTRUSIONS OR GATE BURRS. MOLD FLASH, PROTRUSIONS OR GATE BURRS SHALL NOT EXCEED 0.15 (0.006) PER SIDE.

DIM	MILLIMETERS		INCHES	
	MIN	MAX	MIN	MAX
A	1.75	2.05	0.069	0.081
B	1.75	2.18	0.069	0.086
C	0.85	1.15	0.033	0.045
D	0.40	0.69	0.016	0.027
F	0.70	1.00	0.028	0.039
H	-0.05	+0.10	-0.002	+0.004
J	0.10	0.25	0.004	0.010
K	3.60	3.90	0.142	0.154
L	0.50	0.80	0.020	0.031
R	1.20	1.50	0.047	0.059
S	0.50 REF		0.019 REF	

### SOLDERING FOOTPRINT\*

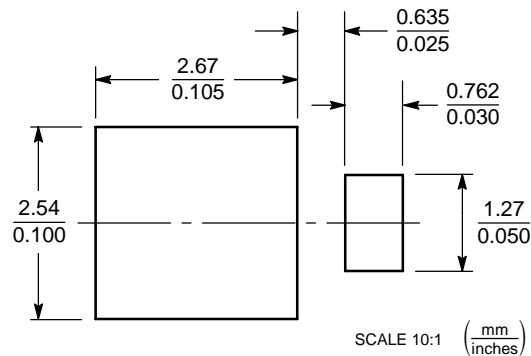

\*For additional information on our Pb-Free strategy and soldering details, please download the ON Semiconductor Soldering and Mounting Techniques Reference Manual, SOLDERRM/D.

# 1PMT5920B Series

POWERMITE is a registered trademark of and used under a license from Microsemi Corporation.

**ON Semiconductor** and **ON** are registered trademarks of Semiconductor Components Industries, LLC (SCILLC). SCILLC reserves the right to make changes without further notice to any products herein. SCILLC makes no warranty, representation or guarantee regarding the suitability of its products for any particular purpose, nor does SCILLC assume any liability arising out of the application or use of any product or circuit, and specifically disclaims any and all liability, including without limitation special, consequential or incidental damages. "Typical" parameters which may be provided in SCILLC data sheets and/or specifications can and do vary in different applications and actual performance may vary over time. All operating parameters, including "Typicals" must be validated for each customer application by customer's technical experts. SCILLC does not convey any license under its patent rights nor the rights of others. SCILLC products are not designed, intended, or authorized for use as components in systems intended for surgical implant into the body, or other applications intended to support or sustain life, or for any other application in which the failure of the SCILLC product could create a situation where personal injury or death may occur. Should Buyer purchase or use SCILLC products for any such unintended or unauthorized application, Buyer shall indemnify and hold SCILLC and its officers, employees, subsidiaries, affiliates, and distributors harmless against all claims, costs, damages, and expenses, and reasonable attorney fees arising out of, directly or indirectly, any claim of personal injury or death associated with such unintended or unauthorized use, even if such claim alleges that SCILLC was negligent regarding the design or manufacture of the part. SCILLC is an Equal Opportunity/Affirmative Action Employer. This literature is subject to all applicable copyright laws and is not for resale in any manner.

## PUBLICATION ORDERING INFORMATION

### LITERATURE FULFILLMENT:

Literature Distribution Center for ON Semiconductor  
P.O. Box 61312, Phoenix, Arizona 85082-1312 USA

**Phone:** 480-829-7710 or 800-344-3860 Toll Free USA/Canada

**Fax:** 480-829-7709 or 800-344-3867 Toll Free USA/Canada

**Email:** [orderlit@onsemi.com](mailto:orderlit@onsemi.com)

**N. American Technical Support:** 800-282-9855 Toll Free  
USA/Canada

**Japan:** ON Semiconductor, Japan Customer Focus Center

2-9-1 Kamimeguro, Meguro-ku, Tokyo, Japan 153-0051

**Phone:** 81-3-5773-3850

**ON Semiconductor Website:** <http://onsemi.com>

**Order Literature:** <http://www.onsemi.com/litorder>

For additional information, please contact your local Sales Representative.

**1PMT5920B/D**