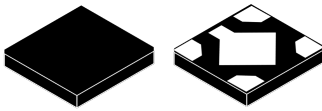


## 500 mA ultra-low dropout linear regulator with bias supply



DFN4 1.2 x 1.2

### Features

- Input voltage from 0.8 to 5.5 V
- Bias supply pin
- Ultra low-dropout voltage (120 mV max. at 500 mA load)
- Low ground current (27  $\mu$ A typ. at no-load)
- Output voltage tolerance:  $\pm$  1.5% overtemperature, 0.5% at 25  $^{\circ}$ C
- 500 mA guaranteed output current
- 50 mV output voltage step available from 0.8 V to 3.6 V
- Logic-controlled electronic shutdown
- Internal current limit with foldback
- Thermal shutdown
- Output active discharge function
- Available in DFN4 1.2 x 1.2 mm package
- Temperature range: -40  $^{\circ}$ C to 85  $^{\circ}$ C

### Applications

- Mobile phones
- Tablets
- Battery-powered systems
- Camera supply

Maturity status link

[LD56050](#)

### Description

The **LD56050** is a high accuracy voltage regulator, which provides 0.5 A of current. It is equipped with an NMOS pass transistor, whose gate is biased by a dedicated pin, thus allowing an ultra low-drop performance even at very low input voltages.

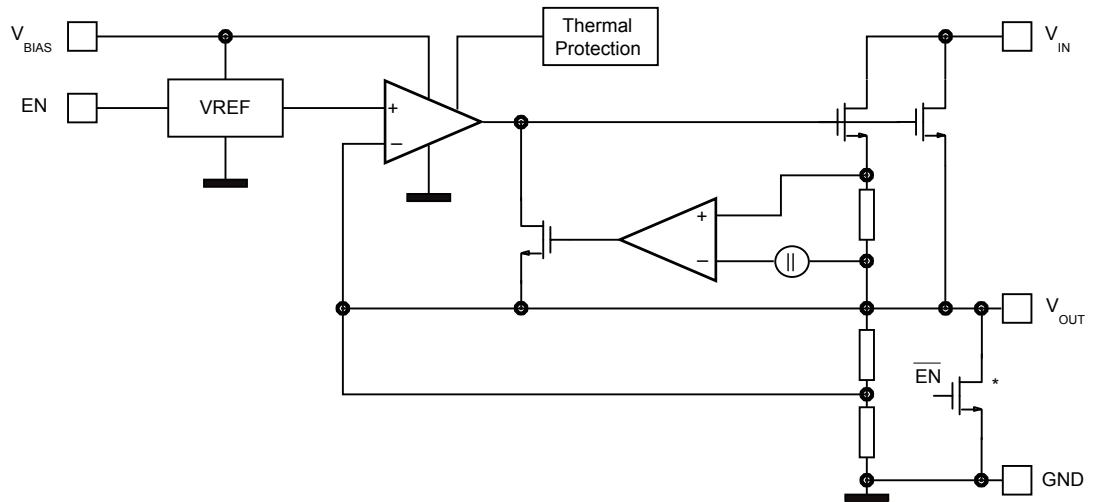
It is available in DFN4 1.2 x 1.2 package, allowing the maximum space saving.

The device is stabilized with a small ceramic capacitor on the output. The ultra low-drop, low quiescent current and short circuit current foldback make the **LD56050** suitable for low power battery-operated applications.

An enable logic control function puts the **LD56050** in shutdown mode allowing a total current consumption lower than 0.1  $\mu$ A. Thermal protection is also included.

1 Diagram

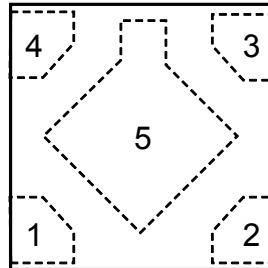
Figure 2. Block diagram



Note: (\*) Output discharge MOSFET.

## 2 Pin configuration

**Figure 3. Pin connection (top view)**

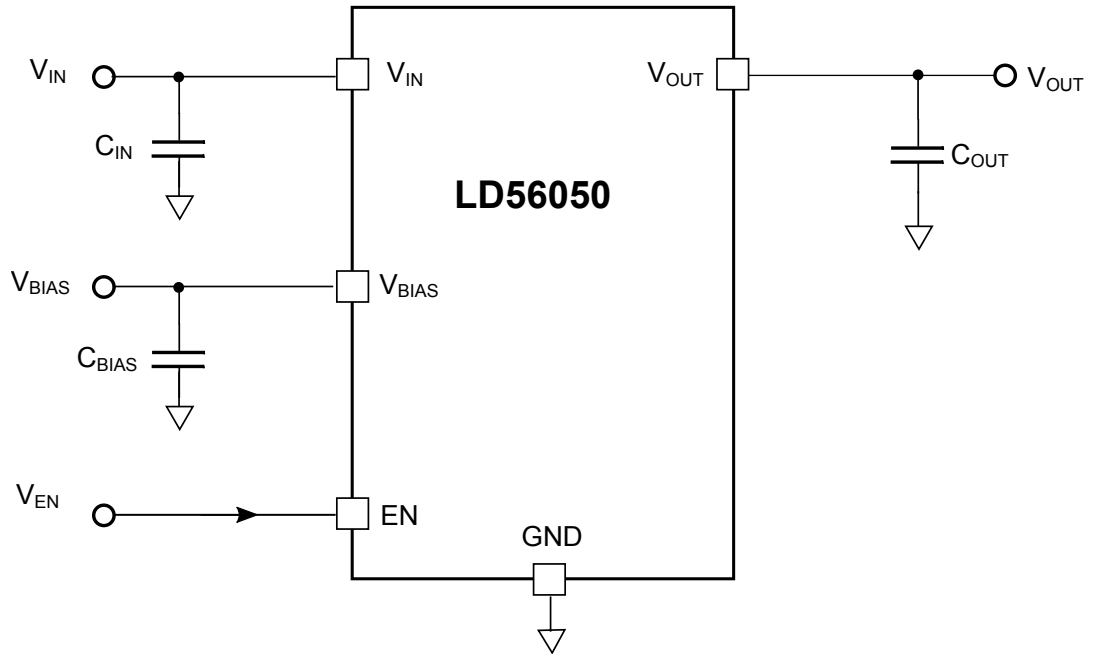


**Table 1. Pin description**

Pin n° DFN8	Symbol	Function
1	$V_{OUT}$	Output voltage
2	$V_{BIAS}$	Bias supply input
3	EN	Enable pin logic input: low = shutdown, high = active. Not internally pulled-up. Don't leave floating.
4	$V_{IN}$	Input voltage (power element)
5	GND	Common ground

### 3 Typical application

**Figure 4. Typical application circuit**



**Table 2. Typical bill of material**

Symbol	Value	Description	Note
$C_{IN}$	1 $\mu$ F	Output voltage	Ceramic type
$C_{BIAS}$	100 nF	Bias supply input	
$C_{OUT}$	2.2 $\mu$ F	Input voltage (power element)	

## 4 Maximum ratings

**Table 3. Absolute maximum ratings**

Symbol	Parameter	Value	Unit
$V_{IN}$	Input voltage	- 0.3 to 7	V
$V_{OUT}$	Output voltage	- 0.3 to $V_{IN} + 0.3$	V
$V_{EN}$	Enable input voltage	- 0.3 to 7	V
$I_{OUT}$	Output current	Internally limited	mA
$P_D$	Power dissipation	Internally limited	mW
$T_{STG}$	Storage temperature range	- 40 to 150	°C
$T_{OP}$	Operating junction temperature range	- 40 to 85	°C

*Note:* Absolute maximum ratings are those values beyond which damage to the device may occur. Functional operation under these conditions is not implied. All values are referred to GND.

**Table 4. Thermal data**

Symbol	Parameter	Value	Unit
$R_{thJA}$	Thermal resistance junction-ambient	170	°C/W

**Table 5. ESD performance**

Symbol	Parameter	Test conditions	Value	Unit
ESD	ESD protection voltage	HBM	2	kV
		CDM	500	V

## 5 Electrical characteristics

$V_{BIAS} = 2.7\text{ V}$  or  $V_{OUT} + 1.6\text{ V}$  (whichever is greater);  $V_{IN} = V_{OUT(NOM)} + 0.3\text{ V}$ ;  $I_{OUT} = 1\text{ mA}$ ;  $C_{IN} = 1\text{ }\mu\text{F}$ ,  $C_{OUT} = 2.2\text{ }\mu\text{F}$ ;  $V_{EN} = 1\text{ V}$ ; typical values are at  $T_J = 25\text{ }^\circ\text{C}$ ; min./max. values are at  $-40\text{ }^\circ\text{C} \leq T_J \leq 85\text{ }^\circ\text{C}$ , unless otherwise specified.

**Table 6. Electrical characteristics**

Symbol	Parameter	Test conditions	Min.	Typ.	Max.	Unit
$V_{IN}$	Operating input voltage		$V_{OUT} + V_{DROP}$		5.5	V
$V_{BIAS}$	Operating bias voltage	$V_{OUT} \leq 1\text{ V}$	2.4		5.5	V
		$V_{OUT} > 1\text{ V}$	$V_{OUT} + 1.4$		5.5	V
$V_{UVLO}$	BIAS undervoltage lockout	$V_{BIAS}$ rising		1.6		V
		Hysteresis		0.2		
$V_{OUT}$	Output voltage accuracy			$\pm 0.5$		%
		$V_{OUT(NOM)} + 0.3\text{ V} \leq V_{IN} \leq V_{OUT(NOM)} + 1.0\text{ V}$ ; $2.7\text{ V}$ or $V_{OUT(NOM)} + 1.6\text{ V}$ (whichever is greater) $\leq V_{BIAS} \leq 5.5\text{ V}$ ; $I_{OUT} = 1\text{ mA}$ to $0.5\text{ A}$ ; $-40\text{ }^\circ\text{C} \leq T_J \leq 85\text{ }^\circ\text{C}$	-1.5		+1.5	%
$\Delta V_{OUT-IN}$	$V_{IN}$ static regulation <sup>(1)</sup>	$V_{OUT(NOM)} + 0.3\text{ V} \leq V_{IN} \leq 5.0\text{ V}$ , $I_{OUT} = 1\text{ mA}$		0.02	0.1	%/V
$\Delta V_{OUT-BIAS}$	$V_{BIAS}$ line regulation <sup>(1)</sup>	$2.7\text{ V}$ or $V_{OUT(NOM)} + 1.6\text{ V}$ (whichever is greater) $\leq V_{BIAS} \leq 5.5\text{ V}$ ; $I_{OUT} = 1\text{ mA}$		0.01	0.1	%/V
$\Delta V_{OUT}$	Static load regulation	$I_{OUT} = 1\text{ mA}$ to $500\text{ mA}$		1.5		mV
$V_{DROP}$	Dropout voltage	$I_{OUT} = 0.15\text{ A}$ ; $V_{OUT} = 97\%$ of $V_{OUT(NOM)}$		13	25	mV
		$I_{OUT} = 0.5\text{ A}$ ; $V_{OUT} = 97\%$ of $V_{OUT(NOM)}$		80	120	
$V_{DROP-BIAS}$	Dropout voltage	$V_{BIAS} = V_{IN}$ ; $I_{OUT} = 0.5\text{ A}$		0.9	1.5	V
$e_N$	Output noise voltage	$V_{OUT(NOM)} = 1.05\text{ V}$ ; $V_{IN} = 1.5\text{ V}$ 10 Hz to 100 kHz, $I_{OUT} = 1\text{ mA}$		38		$\mu\text{V}_{RMS}$
$SVR_{IN}$	$V_{IN}$ supply voltage rejection	$V_{IN} = V_{OUT(NOM)} + 0.5\text{ V} \pm V_{RIPPLE}$ $V_{RIPPLE} = 0.2\text{ V}$ , freq=1 kHz, $I_{OUT} = 150\text{ mA}$ ; $V_{BIAS} = 2.7\text{ V}$ or $V_{OUT} + 1.6\text{ V}$ (whichever is greater)		75		dB
$SVR_{BIAS}$	$V_{BIAS}$ supply voltage rejection	$V_{BIAS} = 2.9\text{ V}$ or $V_{OUT} + 1.8\text{ V}$ (whichever is greater) $\pm V_{RIPPLE}$ $V_{RIPPLE} = 0.2\text{ V}$ freq = 1 kHz $I_{OUT} = 150\text{ mA}$ ; $V_{IN} = V_{OUT(NOM)} + 0.5\text{ V}$		76		dB
$I_{BIAS}$	$V_{BIAS}$ operating current	$I_{OUT} = 0\text{ mA}$ ; $V_{BIAS} = 2.7\text{ V}$		27	40	$\mu\text{A}$
$I_{Standby-BIAS}$	$V_{BIAS}$ standby current	$V_{BIAS}$ input current in OFF MODE: $V_{EN} = \text{GND}$		0.03	1	$\mu\text{A}$
$I_{Standby-IN}$	$V_{IN}$ standby current	$V_{IN}$ input current in OFF MODE: $V_{EN} = \text{GND}$		0.03	1	$\mu\text{A}$
$I_{LIM}$	Output current limit	$V_{OUT} = 0.9 \times V_{OUT(NOM)}$	550	700	1000	mA
$I_{SC}$	Short-circuit current	$V_{OUT} = 0$ (foldback protection)		365	450	mA

Symbol	Parameter	Test conditions	Min.	Typ.	Max.	Unit
$R_{ON}$	Output voltage discharge MOSFET			110		$\Omega$
$V_{EN}$	Enable input logic low				0.4	V
	Enable input logic high		0.9			
$I_{EN}$	Enable pin input current	$V_{EN} = 5.5\text{ V}$			200	nA
$T_{ON}^{(2)}$	Turn on time	$V_{OUT(NOM)} = 1.0\text{ V}$		110		$\mu\text{s}$
$T_{SHDN}$	Thermal shutdown			160		$^{\circ}\text{C}$
	Hysteresis			20		
$C_{OUT}$	Output capacitor		1	2.2	22	$\mu\text{F}$

1. Not applicable for  $V_{OUT(NOM)} \geq 5.0\text{ V}$ .

2. Turn-on time is time measured between the enable input just exceeding  $V_{EN}$  high value and the output voltage just reaching 98% of its nominal value.

**Note:** Values over the temperature range are guaranteed by design and correlation and not tested in production.

## 6 Application information

### 6.1 $V_{BIAS}$ pin voltage requirements

The bias input is the supply of the internal driving and control circuitry. In order to ensure proper biasing of the N-channel power element, the bias pin must have a minimum voltage of 2.4 V and 1.6 V (typically) higher than the output. If  $V_{IN}$  supply voltage meets these requirements then the bias pin can be tied to  $V_{IN}$ .

### 6.2 Output discharge function

The LD56050 integrates a MOSFET connected between  $V_{OUT}$  and GND. This transistor is activated when the EN pin goes to low logic level and has the function to quickly discharge the output capacitor when the device is disabled by the user.

### 6.3 Short circuit and current limitation

The LD56050 is protected against short-circuit on the output. The load current is limited to the maximum value of  $I_{LIM}$  when  $V_{OUT}$  is equal to 90% of its nominal value. If the  $V_{OUT}$  decreases even more due to a lower output load resistance then the foldback circuit starts operating limiting the current to  $I_{SC}$  when  $V_{OUT} = 0$ .

### 6.4 Thermal protection

Thermal protection acts when the junction temperature reaches 160 °C typical. At this point the output of the IC shuts down. As soon as the junction temperature falls below the thermal hysteresis value the device starts working again.

In order to calculate the maximum power that the device can dissipate, keeping the junction temperature below the maximum operating value, the following formula is used:

$$P_{DMAX} = (85 - T_{AMB}) / R_{thJA}$$

### 6.5 Input and output capacitors

The LD56050 requires external capacitors to assure the regulator control loop stability.

Any good quality ceramic capacitor can be used but, the X5R and the X7R are suggested since they guarantee a very stable combination of capacitance and ESR across the temperature range.

Locating the input/output capacitors as close as possible to the relative pins is recommended. The LD56050 requires a  $V_{IN}$  capacitor with a minimum value of 1  $\mu$ F and a  $V_{BIAS}$  capacitor of 100 nF minimum. These capacitors must be located as close as possible to the input pins of the device and returned to a clean analog ground.

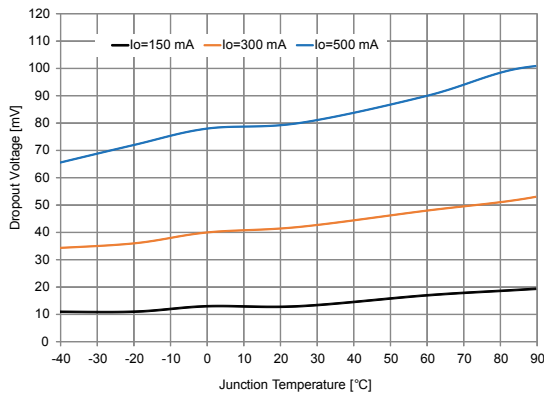
The control loop is designed to be stable with any good quality output ceramic capacitor (such as X5R/X7R types) with a minimum value of 1.0  $\mu$ F and equivalent series resistance in the [3 – 300 m $\Omega$ ] range. It is important to highlight that the output capacitor must maintain its capacitance and ESR in the stable region over the full operating temperature, load and input voltage ranges, to assure stability. Therefore, capacitance and ESR variations must be taken into account in the design phase to ensure the device works in the expected stability region.



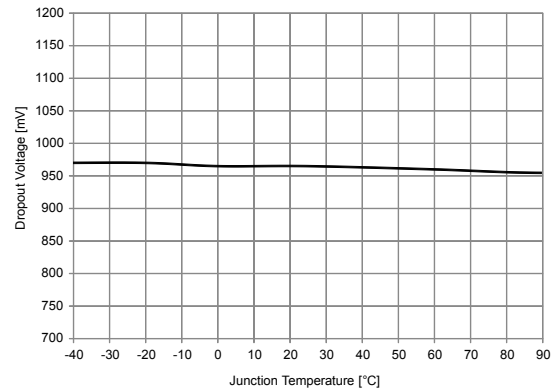
## 7 Typical characteristics

( $V_{OUT} = 1.05\text{ V}$ ;  $C_{IN} = 1\ \mu\text{F}$ ,  $C_{OUT} = 2.2\ \mu\text{F}$ ;  $V_{EN} = 1\text{ V}$ ; unless otherwise specified.)

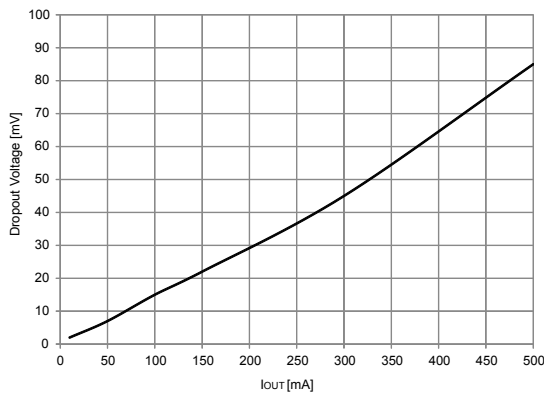
**Figure 5.  $V_{DROP}$  vs. temperature ( $V_{BIAS} = 2.7\text{ V}$ )**



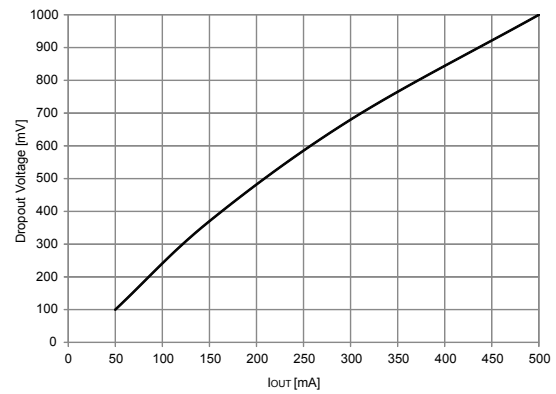
**Figure 6.  $V_{DROP-BIAS}$  vs. temperature ( $I_{OUT} = 500\text{ mA}$ ;  $V_{BIAS} = V_{IN}$ )**



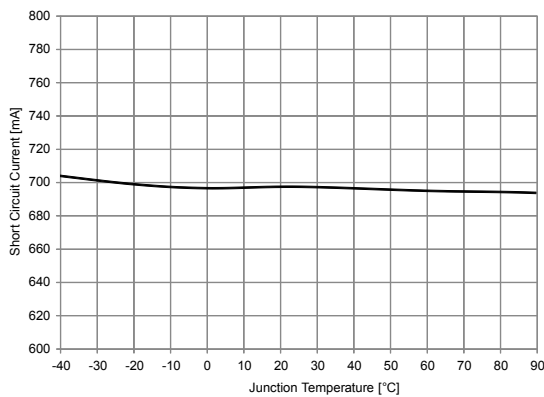
**Figure 7.  $V_{DROP}$  vs.  $I_{OUT}$  ( $V_{BIAS} = 2.7\text{ V}$ )**



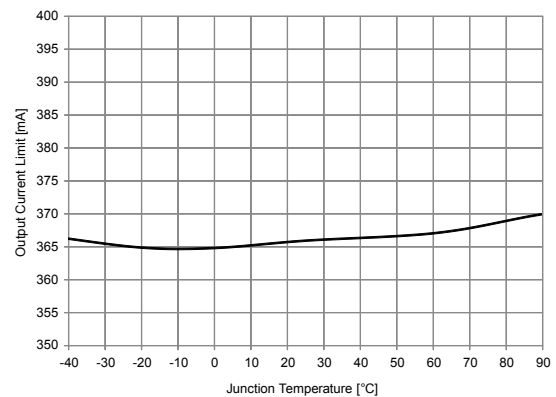
**Figure 8.  $V_{DROP}$  vs.  $I_{OUT}$  ( $V_{BIAS} = V_{IN}$ )**

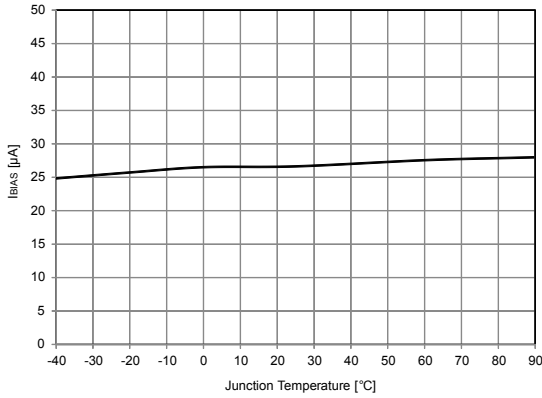
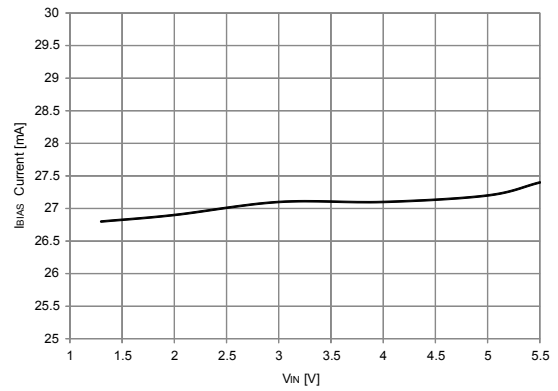
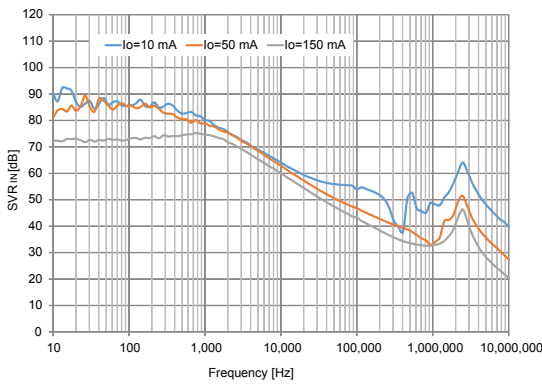
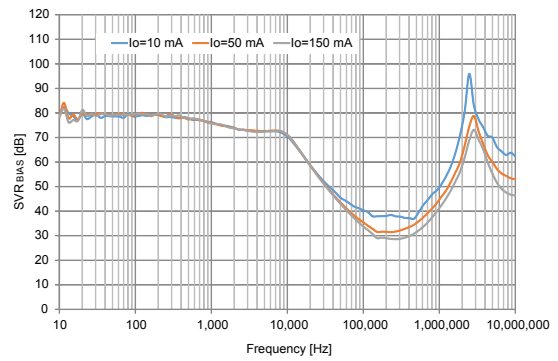
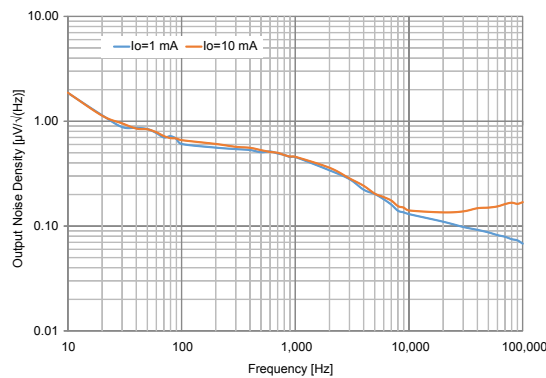


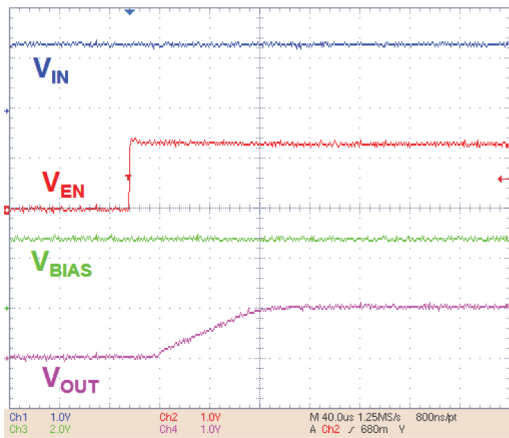
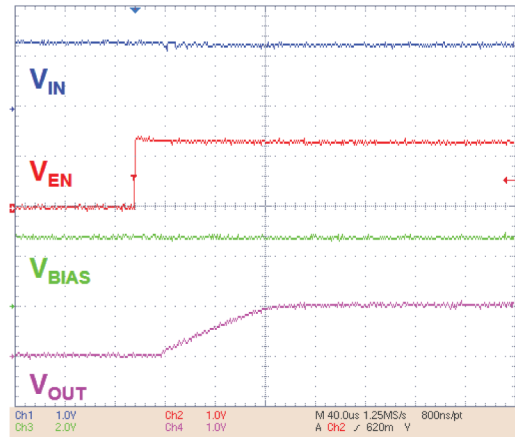
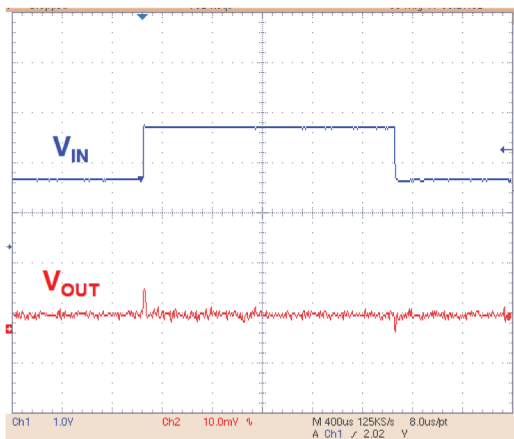
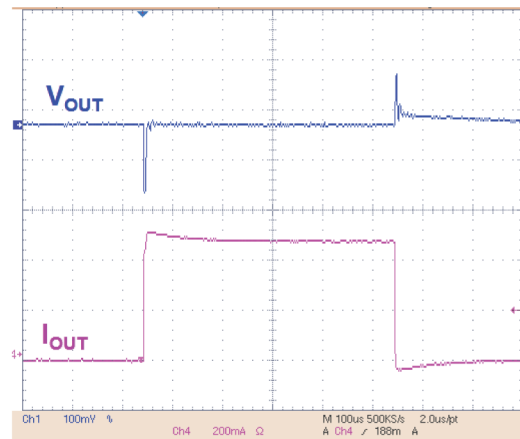
**Figure 9.  $I_{SC}$  vs. temperature ( $V_{IN} = 1.4\text{ V}$ ;  $V_{BIAS} = 2.7\text{ V}$ )**



**Figure 10.  $I_{LIM}$  vs. temperature ( $V_{IN} = 1.4\text{ V}$ ;  $V_{BIAS} = 2.7\text{ V}$ )**



**Figure 11.  $I_{BIAS}$  vs. temperature ( $I_{OUT} = 0$  mA;  $V_{BIAS} = 2.7$  V)**

**Figure 12.  $I_{BIAS}$  vs.  $V_{IN}$  ( $V_{BIAS} = 2.7$  V)**

**Figure 13.  $SVR_{IN}$  vs. frequency ( $V_{IN} = 1.5$  V;  $V_{BIAS} = 2.7$  V;  $V_{OUT} = 1.05$  V)**

**Figure 14.  $SVR_{BIAS}$  vs. frequency ( $V_{IN} = 1.5$  V;  $V_{BIAS} = 2.9$  V;  $V_{OUT} = 1.05$  V)**

**Figure 15. Noise vs. frequency ( $V_{IN} = 1.5$  V;  $V_{BIAS} = 2.7$  V;  $V_{OUT} = 1.05$  V)**


**Figure 16. Turn-on time ( $I_{OUT} = 1 \text{ mA}$ ;  $V_{BIAS} = 2.7 \text{ V}$ )**

**Figure 17. Turn-on time at full load ( $I_{OUT} = 500 \text{ mA}$ ;  $V_{BIAS} = 2.7 \text{ V}$ )**

**Figure 18. Line transient ( $V_{BIAS} = 2.7 \text{ V}$ ,  $V_{IN}$  from 1.35 V to 2.35 V;  $t_R = 5 \mu\text{s}$ )**

**Figure 19. Load transient ( $V_{BIAS} = 2.7 \text{ V}$ ,  $V_{IN} = 1.35 \text{ V}$ ;  $I_{OUT}$  1 to 500 mA)**


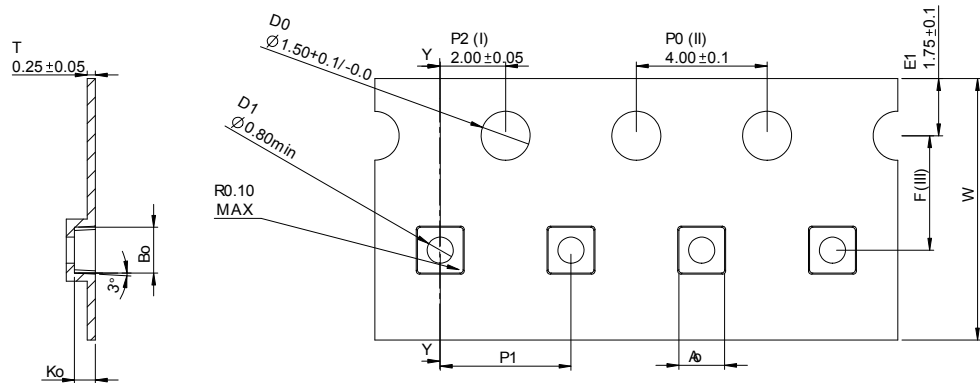
## **8** Package information

---

In order to meet environmental requirements, ST offers these devices in different grades of ECOPACK® packages, depending on their level of environmental compliance. ECOPACK® specifications, grade definitions and product status are available at: [www.st.com](http://www.st.com). ECOPACK® is an ST trademark.

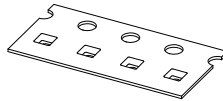




**Figure 22. DFN4 1.2 x 1.2 tape and reel**


SECTION Y-Y  
SCALE 8 : 1

Ao	1.40	+/- 0.05
Bo	1.40	+/- 0.05
Ko	0.64	+/- 0.05
F	3.50	+/- 0.05
P1	4.00	+/- 0.10
W	8.00	+/- 0.10



- (I) Measured from centreline of sprocket hole to centreline of pocket.
- (II) Cumulative tolerance of 10 sprocket holes is  $\pm 0.20$ .
- (III) Measured from centreline of sprocket hole to centreline of pocket.
- (IV) Other material available.

ALL DIMENSIONS IN MILLIMETRES UNLESS OTHERWISE STATED.

**Note:** Pin 1 orientation: bottom-left.

## 9 Ordering information

**Table 8. Order code**

Order code	Discharge function	Output voltage (V)	Marking
LD56050DPU100R	Yes	1.00	UD
LD56050DPU105R	Yes	1.05	UA
LD56050DPU110R	Yes	1.10	UB
LD56050DPU115R	Yes	1.15	UE
LD56050DPU120R	Yes	1.20	UC
LD56050DPU150R	Yes	1.50	UF



## Revision history

**Table 9. Document revision history**

Date	Revision	Changes
02-Feb-2018	1	Initial release.

## Contents

<b>1</b>	<b>Diagram</b> .....	<b>2</b>
<b>2</b>	<b>Pin configuration</b> .....	<b>3</b>
<b>3</b>	<b>Typical application</b> .....	<b>4</b>
<b>4</b>	<b>Maximum ratings</b> .....	<b>5</b>
<b>5</b>	<b>Electrical characteristics</b> .....	<b>6</b>
<b>6</b>	<b>Application information</b> .....	<b>8</b>
<b>6.1</b>	$V_{BIAS}$ pin voltage requirements .....	8
<b>6.2</b>	Output discharge function .....	8
<b>6.3</b>	Short circuit and current limitation .....	8
<b>6.4</b>	Thermal protection .....	8
<b>6.5</b>	Input and output capacitors .....	8
<b>7</b>	<b>Typical characteristics</b> .....	<b>9</b>
<b>8</b>	<b>Package information</b> .....	<b>12</b>
<b>8.1</b>	DFN4 1.2 x 1.2 package information .....	13
<b>9</b>	<b>Ordering information</b> .....	<b>16</b>
	<b>Revision history</b> .....	<b>17</b>

## List of tables

<b>Table 1.</b>	Pin description . . . . .	3
<b>Table 2.</b>	Typical bill of material . . . . .	4
<b>Table 3.</b>	Absolute maximum ratings . . . . .	5
<b>Table 4.</b>	Thermal data . . . . .	5
<b>Table 5.</b>	ESD performance . . . . .	5
<b>Table 6.</b>	Electrical characteristics . . . . .	6
<b>Table 7.</b>	DFN4 1.2 x 1.2 mechanical data . . . . .	14
<b>Table 8.</b>	Order code . . . . .	16
<b>Table 9.</b>	Document revision history . . . . .	17

## List of figures

<b>Figure 2.</b>	Block diagram . . . . .	2
<b>Figure 3.</b>	Pin connection (top view) . . . . .	3
<b>Figure 4.</b>	Typical application circuit . . . . .	4
<b>Figure 5.</b>	$V_{DROD}$ vs. temperature ( $V_{BIAS} = 2.7\text{ V}$ ) . . . . .	9
<b>Figure 6.</b>	$V_{DROD-BIAS}$ vs. temperature ( $I_{OUT} = 500\text{ mA}$ ; $V_{BIAS} = V_{IN}$ ) . . . . .	9
<b>Figure 7.</b>	$V_{DROD}$ vs. $I_{OUT}$ ( $V_{BIAS} = 2.7\text{ V}$ ) . . . . .	9
<b>Figure 8.</b>	$V_{DROD}$ vs. $I_{OUT}$ ( $V_{BIAS} = V_{IN}$ ) . . . . .	9
<b>Figure 9.</b>	$I_{SC}$ vs. temperature ( $V_{IN} = 1.4\text{ V}$ ; $V_{BIAS} = 2.7\text{ V}$ ) . . . . .	9
<b>Figure 10.</b>	$I_{LIM}$ vs. temperature ( $V_{IN} = 1.4\text{ V}$ ; $V_{BIAS} = 2.7\text{ V}$ ) . . . . .	9
<b>Figure 11.</b>	$I_{BIAS}$ vs. temperature ( $I_{OUT} = 0\text{ mA}$ ; $V_{BIAS} = 2.7\text{ V}$ ) . . . . .	10
<b>Figure 12.</b>	$I_{BIAS}$ vs. $V_{IN}$ ( $V_{BIAS} = 2.7\text{ V}$ ) . . . . .	10
<b>Figure 13.</b>	$SVR_{IN}$ vs. frequency ( $V_{IN} = 1.5\text{ V}$ ; $V_{BIAS} = 2.7\text{ V}$ ; $V_{OUT} = 1.05\text{ V}$ ) . . . . .	10
<b>Figure 14.</b>	$SVR_{BIAS}$ vs. frequency ( $V_{IN} = 1.5\text{ V}$ ; $V_{BIAS} = 2.9\text{ V}$ ; $V_{OUT} = 1.05\text{ V}$ ) . . . . .	10
<b>Figure 15.</b>	Noise vs. frequency ( $V_{IN} = 1.5\text{ V}$ ; $V_{BIAS} = 2.7\text{ V}$ ; $V_{OUT} = 1.05\text{ V}$ ) . . . . .	10
<b>Figure 16.</b>	Turn-on time ( $I_{OUT} = 1\text{ mA}$ ; $V_{BIAS} = 2.7\text{ V}$ ) . . . . .	11
<b>Figure 17.</b>	Turn-on time at full load ( $I_{OUT} = 500\text{ mA}$ ; $V_{BIAS} = 2.7\text{ V}$ ) . . . . .	11
<b>Figure 18.</b>	Line transient ( $V_{BIAS} = 2.7\text{ V}$ , $V_{IN}$ from $1.35\text{ V}$ to $2.35\text{ V}$ ; $t_R = 5\text{ }\mu\text{s}$ ) . . . . .	11
<b>Figure 19.</b>	Load transient ( $V_{BIAS} = 2.7\text{ V}$ , $V_{IN} = 1.35\text{ V}$ ; $I_{OUT}$ 1 to $500\text{ mA}$ ) . . . . .	11
<b>Figure 20.</b>	DFN4 1.2 x 1.2 package outline . . . . .	13
<b>Figure 21.</b>	DFN4 1.2 x 1.2 recommended footprint . . . . .	14
<b>Figure 22.</b>	DFN4 1.2 x 1.2 tape and reel . . . . .	15

**IMPORTANT NOTICE – PLEASE READ CAREFULLY**

STMicroelectronics NV and its subsidiaries (“ST”) reserve the right to make changes, corrections, enhancements, modifications, and improvements to ST products and/or to this document at any time without notice. Purchasers should obtain the latest relevant information on ST products before placing orders. ST products are sold pursuant to ST’s terms and conditions of sale in place at the time of order acknowledgement.

Purchasers are solely responsible for the choice, selection, and use of ST products and ST assumes no liability for application assistance or the design of Purchasers’ products.

No license, express or implied, to any intellectual property right is granted by ST herein.

Resale of ST products with provisions different from the information set forth herein shall void any warranty granted by ST for such product.

ST and the ST logo are trademarks of ST. All other product or service names are the property of their respective owners.

Information in this document supersedes and replaces information previously supplied in any prior versions of this document.

© 2018 STMicroelectronics – All rights reserved