

M1MA151WK, M1MA152WK

Common Cathode Silicon Dual Switching Diodes

These Common Cathode Silicon Epitaxial Planar Dual Diodes are designed for use in ultra high speed switching applications. These devices are housed in the SC-59 package which is designed for low power surface mount applications.

Features

- Fast t_{rr} , < 3.0 ns
- Low C_D , < 2.0 pF
- S and NSV Prefix for Automotive and Other Applications Requiring Unique Site and Control Change Requirements; AEC-Q101 Qualified and PPAP Capable
- These Devices are Pb-Free and are RoHS Compliant

MAXIMUM RATINGS ($T_A = 25^\circ\text{C}$)

| Rating | Symbol | Value | Unit |
|--|-----------------------|------------|------|
| Reverse Voltage M1MA151WK M1MA152WK | V_R | 40 80 | Vdc |
| Peak Reverse Voltage M1MA151WK M1MA152WK | V_{RM} | 40 80 | Vdc |
| Forward Current Single Dual | I_F | 100 150 | mAdc |
| Peak Forward Current Single Dual | I_{FM} | 225 340 | mAdc |
| Peak Forward Surge Current Single Dual | I_{FSM} (Note 1) | 500 750 | mAdc |

THERMAL CHARACTERISTICS

| Rating | Symbol | Max | Unit |
|----------------------|-----------|-------------|------------------|
| Power Dissipation | P_D | 200 | mW |
| Junction Temperature | T_J | 150 | $^\circ\text{C}$ |
| Storage Temperature | T_{stg} | -55 to +150 | $^\circ\text{C}$ |

Stresses exceeding those listed in the Maximum Ratings table may damage the device. If any of these limits are exceeded, device functionality should not be assumed, damage may occur and reliability may be affected.

1. $t = 1$ sec



ON Semiconductor®

www.onsemi.com

**SC-59 PACKAGE SINGLE SILICON
SWITCHING DIODES 40 V/80 V 100 mA
SURFACE MOUNT**



**SC-59
CASE 318D
STYLE 3**

3 CATHODE

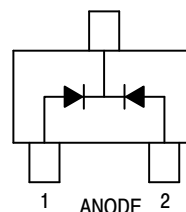

MARKING DIAGRAM

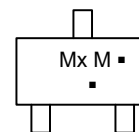

Mx = Device Code
x = T for 151
U for 152
M = Date Code*
▪ = Pb-Free Package

(Note: Microdot may be in either location)
*Date Code orientation may vary depending upon manufacturing location.

ORDERING INFORMATION

| Device | Package | Shipping† |
|-----------------|--------------------|------------------------|
| M1MA151WKT1G | SC-59 (Pb-Free) | 3,000 / Tape & Reel |
| SM1MA151WKT1G | SC-59 (Pb-Free) | 3,000 / Tape & Reel |
| M1MA152WKT1G | SC-59 (Pb-Free) | 3,000 / Tape & Reel |
| NSVM1MA152WKT1G | SC-59 (Pb-Free) | 3,000 / Tape & Reel |

†For information on tape and reel specifications, including part orientation and tape sizes, please refer to our Tape and Reel Packaging Specifications Brochure, BRD8011/D.

M1MA151WK, M1MA152WK

ELECTRICAL CHARACTERISTICS ($T_A = 25^\circ\text{C}$)

| Characteristic | Symbol | Condition | Min | Max | Unit |
|---|----------------------|--|----------|------------|------------------|
| Reverse Voltage Leakage Current M1MA151WK M1MA152WK | I_R | $V_R = 35\text{ V}$ $V_R = 75\text{ V}$ | – – | 0.1 0.1 | $\mu\text{A dc}$ |
| Forward Voltage | V_F | $I_F = 100\text{ mA}$ | – | 1.2 | Vdc |
| Reverse Breakdown Voltage M1MA151WK M1MA152WK | V_R | $I_R = 100\ \mu\text{A}$ | 40 80 | – – | Vdc |
| Diode Capacitance | C_D | $V_R = 0, f = 1.0\text{ MHz}$ | – | 2.0 | pF |
| Reverse Recovery Time (Figure 1) | t_{rr} (Note 2) | $I_F = 10\text{ mA}, V_R = 6.0\text{ V},$ $R_L = 100\ \Omega, I_{rr} = 0.1 I_R$ | – | 3.0 | ns |

2. t_{rr} Test Circuit

RECOVERY TIME EQUIVALENT TEST CIRCUIT

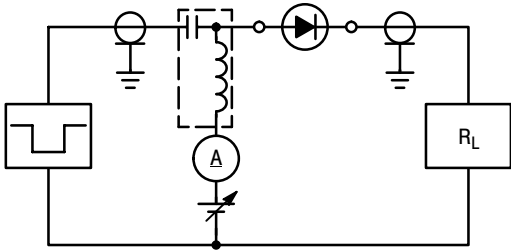

INPUT PULSE

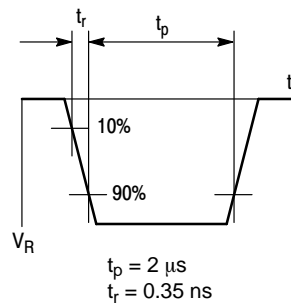

OUTPUT PULSE

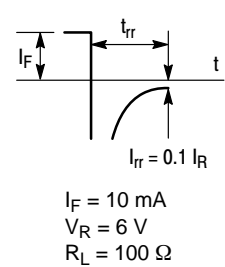

Figure 1. Reverse Recovery Time Equivalent Test Circuit

M1MA151WK, M1MA152WK

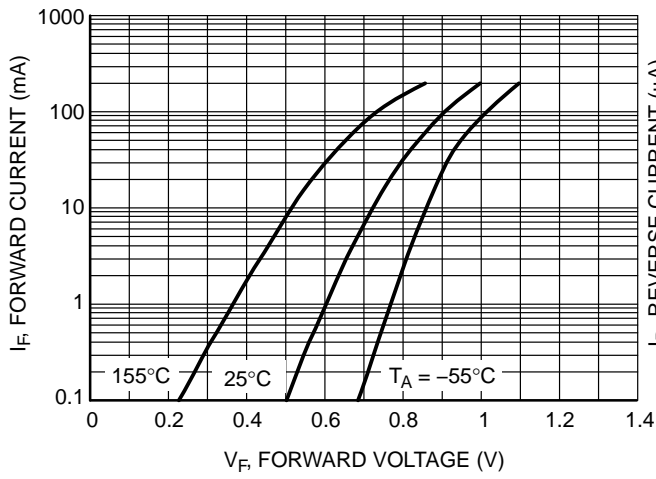

Figure 2. Forward Voltage

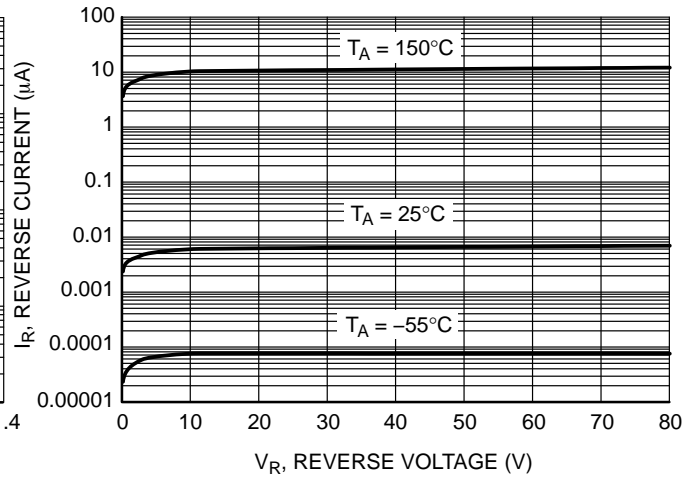

Figure 3. Reverse Leakage

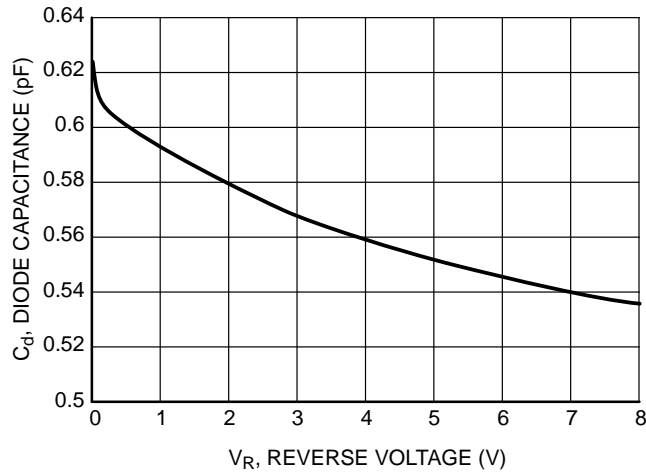

Figure 4. Diode Capacitance

MECHANICAL CASE OUTLINE

PACKAGE DIMENSIONS

ON Semiconductor®



SC-59
CASE 318D-04
ISSUE H

DATE 28 JUN 2012

SCALE 2:1

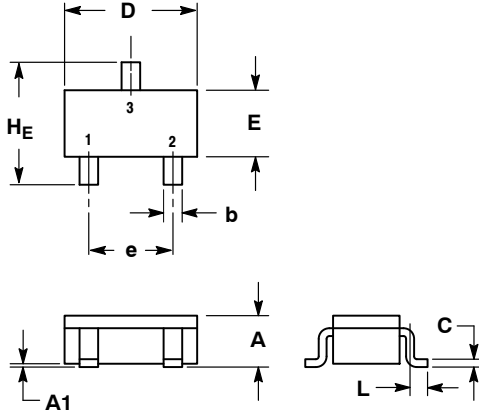

SOLDERING FOOTPRINT*

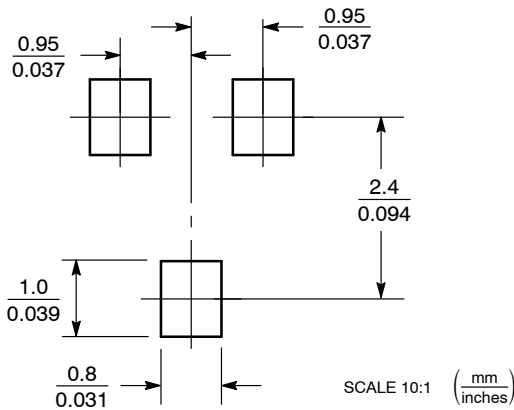

NOTES:
1. DIMENSIONING AND TOLERANCING PER ANSI Y14.5M, 1982.
2. CONTROLLING DIMENSION: MILLIMETER.

| DIM | MILLIMETERS | | | INCHES | | |
|-----|-------------|------|------|--------|-------|-------|
| | MIN | NOM | MAX | MIN | NOM | MAX |
| A | 1.00 | 1.15 | 1.30 | 0.039 | 0.045 | 0.051 |
| A1 | 0.01 | 0.06 | 0.10 | 0.001 | 0.002 | 0.004 |
| b | 0.35 | 0.43 | 0.50 | 0.014 | 0.017 | 0.020 |
| c | 0.09 | 0.14 | 0.18 | 0.003 | 0.005 | 0.007 |
| D | 2.70 | 2.90 | 3.10 | 0.106 | 0.114 | 0.122 |
| E | 1.30 | 1.50 | 1.70 | 0.051 | 0.059 | 0.067 |
| e | 1.70 | 1.90 | 2.10 | 0.067 | 0.075 | 0.083 |
| L | 0.20 | 0.40 | 0.60 | 0.008 | 0.016 | 0.024 |
| HE | 2.50 | 2.80 | 3.00 | 0.099 | 0.110 | 0.118 |

GENERIC MARKING DIAGRAM

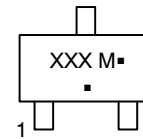

XXX = Specific Device Code
M = Date Code
▪ = Pb-Free Package*

(*Note: Microdot may be in either location)

*This information is generic. Please refer to device data sheet for actual part marking. Pb-Free indicator, "G" or microdot "▪", may or may not be present.

STYLE 1:
PIN 1. BASE
2. EMITTER
3. COLLECTOR

STYLE 2:
PIN 1. ANODE
2. N.C.
3. CATHODE

STYLE 3:
PIN 1. ANODE
2. ANODE
3. CATHODE

STYLE 4:
PIN 1. CATHODE
2. N.C.
3. ANODE

STYLE 5:
PIN 1. CATHODE
2. CATHODE
3. ANODE

STYLE 6:
PIN 1. ANODE
2. CATHODE
3. ANODE/CATHODE

*For additional information on our Pb-Free strategy and soldering details, please download the ON Semiconductor Soldering and Mounting Techniques Reference Manual, SOLDERRM/D.

| | | |
|------------------|-------------|--|
| DOCUMENT NUMBER: | 98ASB42664B | Electronic versions are uncontrolled except when accessed directly from the Document Repository. Printed versions are uncontrolled except when stamped "CONTROLLED COPY" in red. |
| DESCRIPTION: | SC-59 | PAGE 1 OF 1 |

ON Semiconductor and ON are trademarks of Semiconductor Components Industries, LLC dba ON Semiconductor or its subsidiaries in the United States and/or other countries. ON Semiconductor reserves the right to make changes without further notice to any products herein. ON Semiconductor makes no warranty, representation or guarantee regarding the suitability of its products for any particular purpose, nor does ON Semiconductor assume any liability arising out of the application or use of any product or circuit, and specifically disclaims any and all liability, including without limitation special, consequential or incidental damages. ON Semiconductor does not convey any license under its patent rights nor the rights of others.

onsemi, **Onsemi**, and other names, marks, and brands are registered and/or common law trademarks of Semiconductor Components Industries, LLC dba "**onsemi**" or its affiliates and/or subsidiaries in the United States and/or other countries. **onsemi** owns the rights to a number of patents, trademarks, copyrights, trade secrets, and other intellectual property. A listing of **onsemi**'s product/patent coverage may be accessed at www.onsemi.com/site/pdf/Patent-Marking.pdf. **onsemi** reserves the right to make changes at any time to any products or information herein, without notice. The information herein is provided "as-is" and **onsemi** makes no warranty, representation or guarantee regarding the accuracy of the information, product features, availability, functionality, or suitability of its products for any particular purpose, nor does **onsemi** assume any liability arising out of the application or use of any product or circuit, and specifically disclaims any and all liability, including without limitation special, consequential or incidental damages. Buyer is responsible for its products and applications using **onsemi** products, including compliance with all laws, regulations and safety requirements or standards, regardless of any support or applications information provided by **onsemi**. "Typical" parameters which may be provided in **onsemi** data sheets and/or specifications can and do vary in different applications and actual performance may vary over time. All operating parameters, including "Typicals" must be validated for each customer application by customer's technical experts. **onsemi** does not convey any license under any of its intellectual property rights nor the rights of others. **onsemi** products are not designed, intended, or authorized for use as a critical component in life support systems or any FDA Class 3 medical devices or medical devices with a same or similar classification in a foreign jurisdiction or any devices intended for implantation in the human body. Should Buyer purchase or use **onsemi** products for any such unintended or unauthorized application, Buyer shall indemnify and hold **onsemi** and its officers, employees, subsidiaries, affiliates, and distributors harmless against all claims, costs, damages, and expenses, and reasonable attorney fees arising out of, directly or indirectly, any claim of personal injury or death associated with such unintended or unauthorized use, even if such claim alleges that **onsemi** was negligent regarding the design or manufacture of the part. **onsemi** is an Equal Opportunity/Affirmative Action Employer. This literature is subject to all applicable copyright laws and is not for resale in any manner.

PUBLICATION ORDERING INFORMATION

LITERATURE FULFILLMENT:

Email Requests to: orderlit@onsemi.com

onsemi Website: www.onsemi.com

TECHNICAL SUPPORT

North American Technical Support:

Voice Mail: 1 800-282-9855 Toll Free USA/Canada

Phone: 011 421 33 790 2910

Europe, Middle East and Africa Technical Support:

Phone: 00421 33 790 2910

For additional information, please contact your local Sales Representative

