

ON Semiconductor

Is Now

onsemi™

To learn more about onsemi™, please visit our website at
www.onsemi.com

onsemi and **onsemi** and other names, marks, and brands are registered and/or common law trademarks of Semiconductor Components Industries, LLC dba "**onsemi**" or its affiliates and/or subsidiaries in the United States and/or other countries. **onsemi** owns the rights to a number of patents, trademarks, copyrights, trade secrets, and other intellectual property. A listing of **onsemi** product/patent coverage may be accessed at www.onsemi.com/site/pdf/Patent-Marking.pdf. **onsemi** reserves the right to make changes at any time to any products or information herein, without notice. The information herein is provided "as-is" and **onsemi** makes no warranty, representation or guarantee regarding the accuracy of the information, product features, availability, functionality, or suitability of its products for any particular purpose, nor does **onsemi** assume any liability arising out of the application or use of any product or circuit, and specifically disclaims any and all liability, including without limitation special, consequential or incidental damages. Buyer is responsible for its products and applications using **onsemi** products, including compliance with all laws, regulations and safety requirements or standards, regardless of any support or applications information provided by **onsemi**. "Typical" parameters which may be provided in **onsemi** data sheets and/or specifications can and do vary in different applications and actual performance may vary over time. All operating parameters, including "Typicals" must be validated for each customer application by customer's technical experts. **onsemi** does not convey any license under any of its intellectual property rights nor the rights of others. **onsemi** products are not designed, intended, or authorized for use as a critical component in life support systems or any FDA Class 3 medical devices or medical devices with a same or similar classification in a foreign jurisdiction or any devices intended for implantation in the human body. Should Buyer purchase or use **onsemi** products for any such unintended or unauthorized application, Buyer shall indemnify and hold **onsemi** and its officers, employees, subsidiaries, affiliates, and distributors harmless against all claims, costs, damages, and expenses, and reasonable attorney fees arising out of, directly or indirectly, any claim of personal injury or death associated with such unintended or unauthorized use, even if such claim alleges that **onsemi** was negligent regarding the design or manufacture of the part. **onsemi** is an Equal Opportunity/Affirmative Action Employer. This literature is subject to all applicable copyright laws and is not for resale in any manner. Other names and brands may be claimed as the property of others.

MOSFET - N-Channel Shielded Gate PowerTrench®

150 V, 7.3 mΩ, 101 A

NTB7D3N15MC

Features

- Shielded Gate MOSFET Technology
- Max $R_{DS(on)} = 7.3 \text{ m}\Omega$ at $V_{GS} = 10 \text{ V}$, $I_D = 62 \text{ A}$
- 50% Lower Q_{rr} than other MOSFET Suppliers
- Lowers Switching Noise/EMI
- 100% UIL Tested
- These Devices are Pb-Free, Halogen Free/BFR Free and are RoHS Compliant

Typical Applications

- Synchronous Rectification for ATX / Server / Telecom PSU
- Motor Drives and Uninterruptible Power Supplies
- Micro Solar Inverter

MAXIMUM RATINGS ($T_J = 25^\circ\text{C}$ unless otherwise noted)

Parameter	Symbol	Value	Unit	
Drain-to-Source Voltage	V_{DSS}	150	V	
Gate-to-Source Voltage	V_{GS}	± 20	V	
Continuous Drain Current $R_{\theta JC}$ (Note 2)	I_D	101	A	
Power Dissipation $R_{\theta JC}$ (Note 2)				P_D
Continuous Drain Current $R_{\theta JA}$ (Notes 1, 2)	I_D	15.2	A	
Power Dissipation $R_{\theta JA}$ (Notes 1, 2)				P_D
Pulsed Drain Current	$T_C = 25^\circ\text{C}$, $t_p = 100 \mu\text{s}$	I_{DM}	488	A
Operating Junction and Storage Temperature Range	T_J, T_{stg}	-55 to +175	$^\circ\text{C}$	
Single Pulse Drain-to-Source Avalanche Energy ($I_L = 20 \text{ A}_{pk}$, $L = 3 \text{ mH}$)	E_{AS}	600	mJ	
Lead Temperature for Soldering Purposes (1/8" from case for 10 s)	T_L	260	$^\circ\text{C}$	

Stresses exceeding those listed in the Maximum Ratings table may damage the device. If any of these limits are exceeded, device functionality should not be assumed, damage may occur and reliability may be affected.

1. Surface-mounted on FR4 board using a 1 in², 2 oz. Cu pad.
2. The entire application environment impacts the thermal resistance values shown, they are not constants and are only valid for the particular conditions noted.



ON Semiconductor®

www.onsemi.com

$V_{(BR)DSS}$	$R_{DS(ON)} \text{ MAX}$	$I_D \text{ MAX}$
150 V	7.3 mΩ @ 10 V	101 A

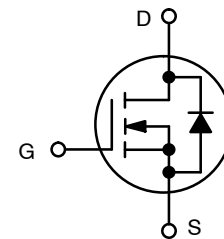

N-CHANNEL MOSFET

MARKING DIAGRAM

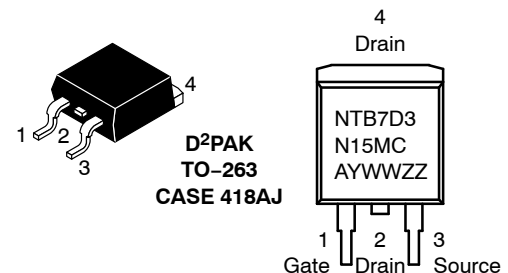

NTB7D3N15MC = Specific Device Code
 A = Assembly Location
 Y = Year
 WW = Work Week
 ZZ = Lot Traceability

ORDERING INFORMATION

Device	Package	Shipping†
NTB7D3N15MC	D ² PAK (Pb-Free)	800 / Tape & Reel

†For information on tape and reel specifications, including part orientation and tape sizes, please refer to our Tape and Reel Packaging Specifications Brochure, BRD8011/D.

NTB7D3N15MC

THERMAL RESISTANCE MAXIMUM RATINGS

Parameter	Symbol	Value	Unit
Junction-to-Case – Steady State (Note 2)	$R_{\theta JC}$	0.9	°C/W
Junction-to-Ambient – Steady State (Notes 1, 2)	$R_{\theta JA}$	40	

ELECTRICAL CHARACTERISTICS ($T_J = 25^\circ\text{C}$ unless otherwise noted)

Parameter	Symbol	Test Condition	Min	Typ	Max	Unit
-----------	--------	----------------	-----	-----	-----	------

OFF CHARACTERISTICS

Drain-to-Source Breakdown Voltage	$V_{(BR)DSS}$	$V_{GS} = 0\text{ V}, I_D = 250\ \mu\text{A}$	150			V
Drain-to-Source Breakdown Voltage Temperature Coefficient	$V_{(BR)DSS}/T_J$	$I_D = 250\ \mu\text{A}$, ref to 25°C		71		mV/°C
Zero Gate Voltage Drain Current	I_{DSS}	$V_{GS} = 0\text{ V}, V_{DS} = 120\text{ V}$			1.0	μA
Gate-to-Source Leakage Current	I_{GSS}	$V_{DS} = 0\text{ V}, V_{GS} = \pm 20\text{ V}$			± 100	nA

ON CHARACTERISTICS

Gate Threshold Voltage	$V_{GS(TH)}$	$V_{GS} = V_{DS}, I_D = 342\ \mu\text{A}$	2.5		4.5	V
Negative Threshold Temperature Coefficient	$V_{GS(TH)}/T_J$	$I_D = 342\ \mu\text{A}$, ref to 25°C		-7.3		mV/°C
Drain-to-Source On Resistance	$R_{DS(on)}$	$V_{GS} = 10\text{ V}, I_D = 62\text{ A}$		6.0	7.3	m Ω
		$V_{GS} = 8\text{ V}, I_D = 31\text{ A}$		6.5	8.4	
Forward Transconductance	g_{FS}	$V_{DS} = 10\text{ V}, I_D = 62\text{ A}$		119		S

CHARGES, CAPACITANCES & GATE RESISTANCE

Input Capacitance	C_{ISS}	$V_{GS} = 0\text{ V}, f = 1\text{ MHz}, V_{DS} = 75\text{ V}$		4250		pF
Output Capacitance	C_{OSS}			1250		
Reverse Transfer Capacitance	C_{RSS}			15		
Gate-Resistance	R_G			0.8	1.6	Ω
Total Gate Charge	$Q_{G(TOT)}$	$V_{GS} = 10\text{ V}, V_{DS} = 75\text{ V}; I_D = 62\text{ A}$		53		nC
Threshold Gate Charge	$Q_{G(TH)}$			14		
Gate-to-Source Charge	Q_{GS}			23		
Gate-to-Drain Charge	Q_{GD}			8.5		
Plateau Voltage	V_{GP}			5.8		
Output Charge	Q_{OSS}	$V_{DD} = 75\text{ V}, V_{GS} = 0\text{ V}$		133		nC

SWITCHING CHARACTERISTICS (Note 3)

Turn-On Delay Time	$t_{d(ON)}$	$V_{GS} = 10\text{ V}, V_{DD} = 75\text{ V}, I_D = 62\text{ A}, R_G = 4.7\ \Omega$		27		ns
Rise Time	t_r			8.5		
Turn-Off Delay Time	$t_{d(OFF)}$			33		
Fall Time	t_f			5.8		

DRAIN-SOURCE DIODE CHARACTERISTICS

Forward Diode Voltage	V_{SD}	$V_{GS} = 0\text{ V}, I_S = 62\text{ A}$	$T_J = 25^\circ\text{C}$		0.93	1.2	V
Reverse Recovery Time	t_{RR}	$V_{GS} = 0\text{ V}, V_{DD} = 75\text{ V}$ $di_S/dt = 300\text{ A}/\mu\text{s}, I_S = 62\text{ A}$			55		ns
Reverse Recovery Charge	Q_{RR}				247		nC
Reverse Recovery Time	t_{RR}	$V_{GS} = 0\text{ V}, V_{DD} = 75\text{ V}$ $di_S/dt = 1000\text{ A}/\mu\text{s}, I_S = 62\text{ A}$			50		ns
Reverse Recovery Charge	Q_{RR}				720		nC

Product parametric performance is indicated in the Electrical Characteristics for the listed test conditions, unless otherwise noted. Product performance may not be indicated by the Electrical Characteristics if operated under different conditions.

3. Switching characteristics are independent of operating junction temperatures.

NTB7D3N15MC

TYPICAL CHARACTERISTICS

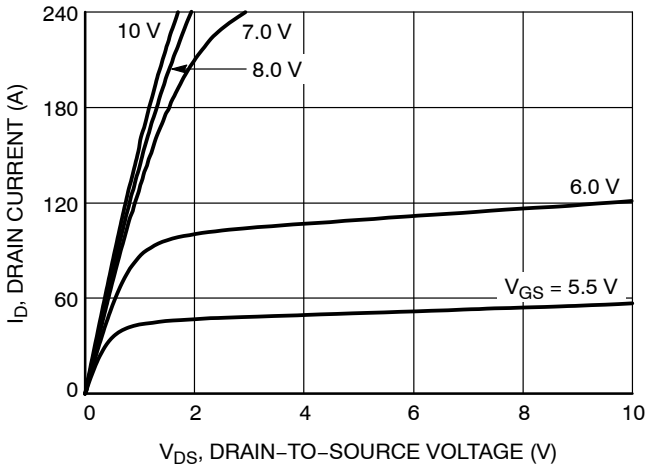

Figure 1. On-Region Characteristics

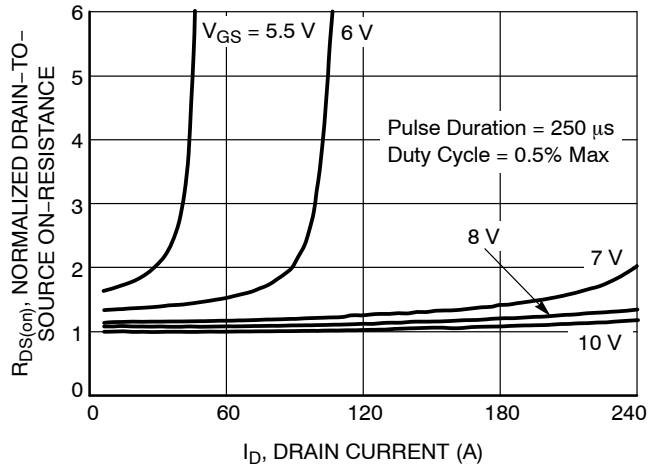

Figure 2. Normalized On-Resistance vs. Drain Current and Gate Voltage

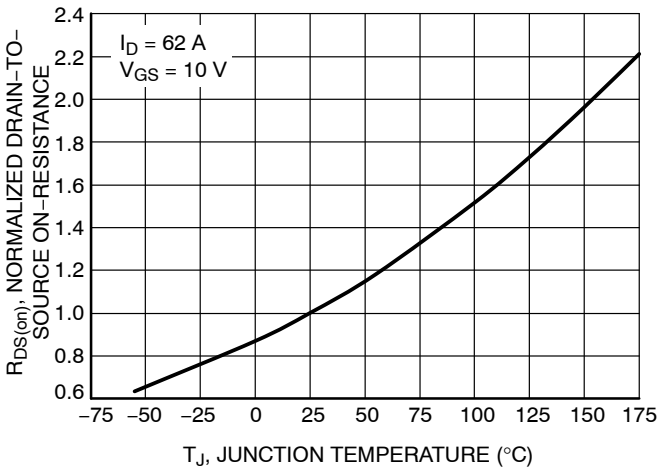

Figure 3. Normalized On-Resistance vs. Junction Temperature

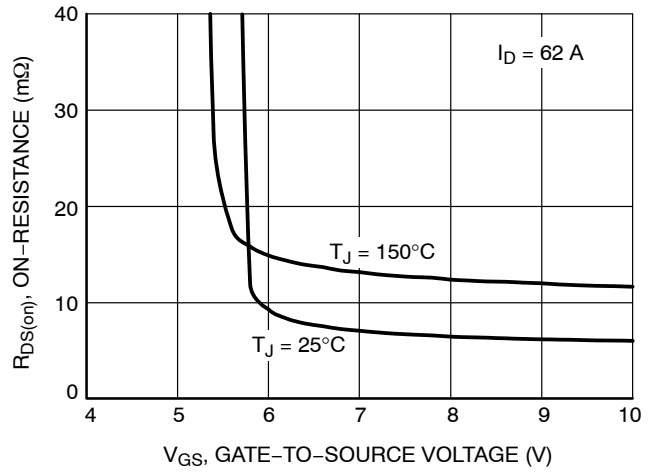

Figure 4. On-Resistance vs. Gate-to-Source Voltage

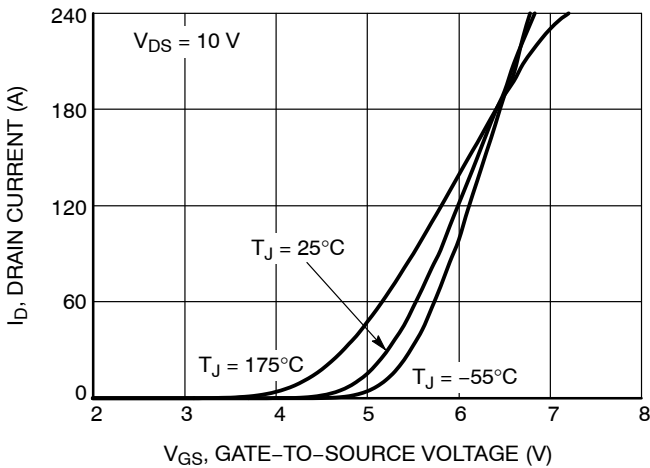

Figure 5. Transfer Characteristics

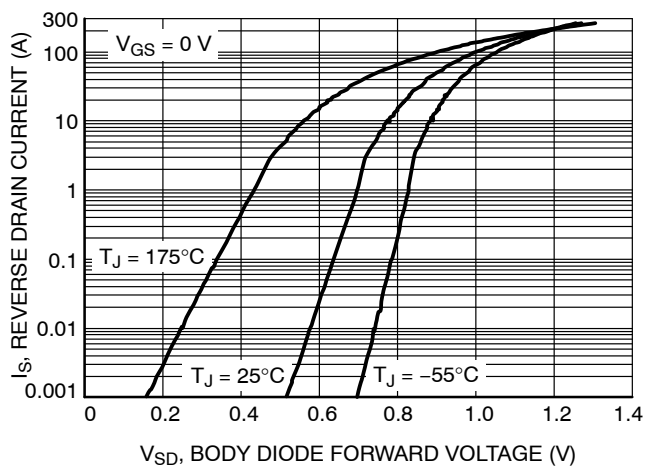

Figure 6. Source-to-Drain Diode Forward Voltage vs. Source Current

NTB7D3N15MC

TYPICAL CHARACTERISTICS

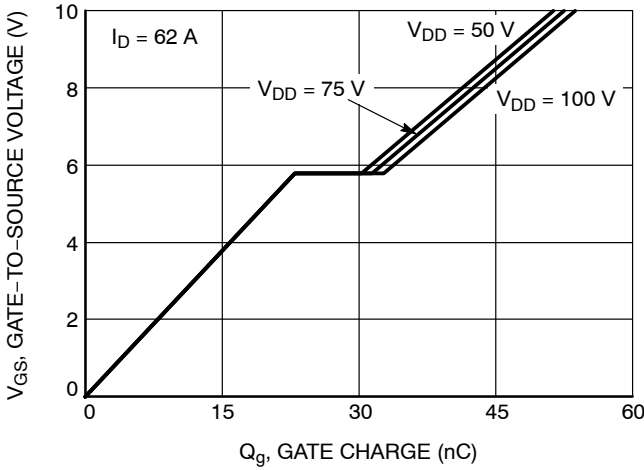

Figure 7. Gate Charge Characteristics

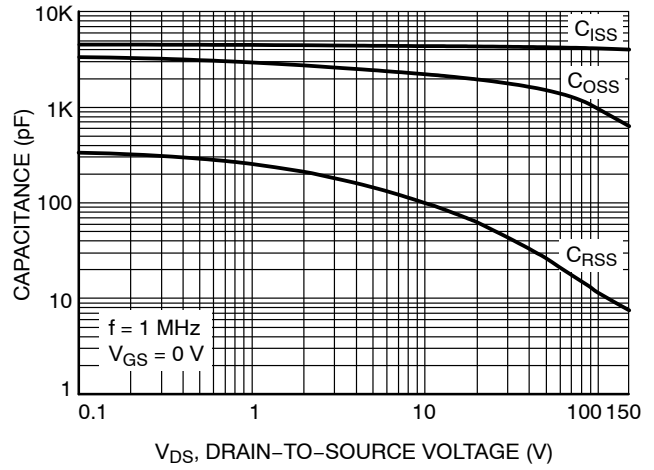

Figure 8. Capacitance vs. Drain-to-Source Voltage

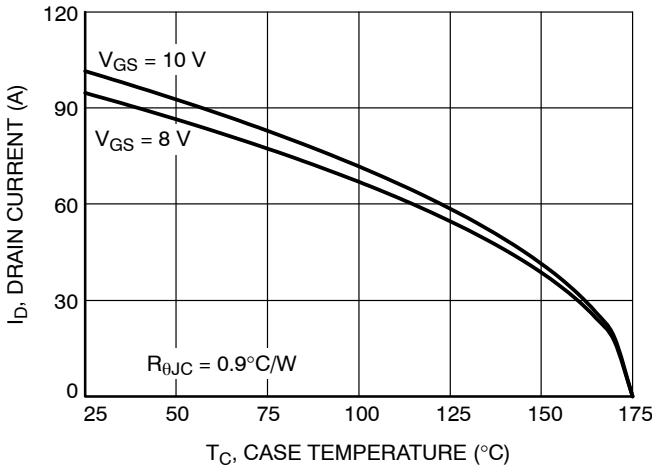

Figure 9. Drain Current vs. Case Temperature

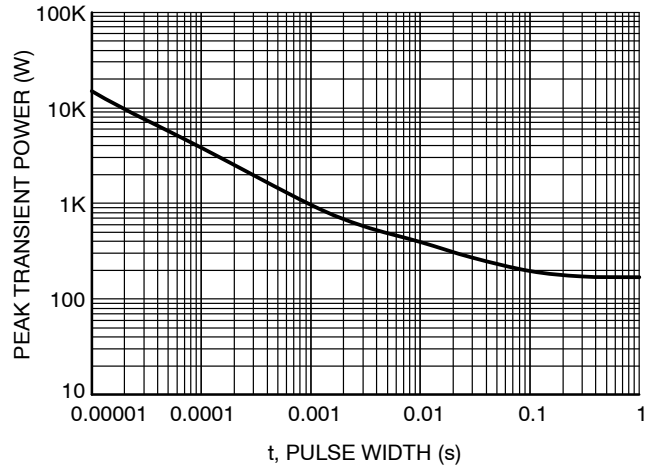

Figure 10. Peak Power

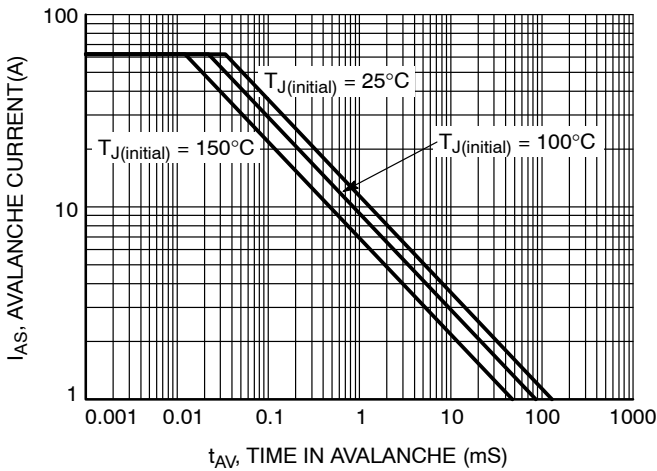

Figure 11. Unclamped Inductive Switching Capability

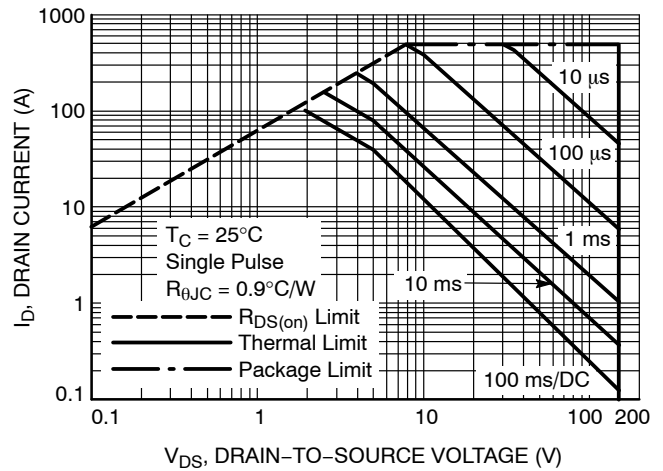

Figure 12. Forward Bias Safe Operating Area

NTB7D3N15MC

TYPICAL CHARACTERISTICS

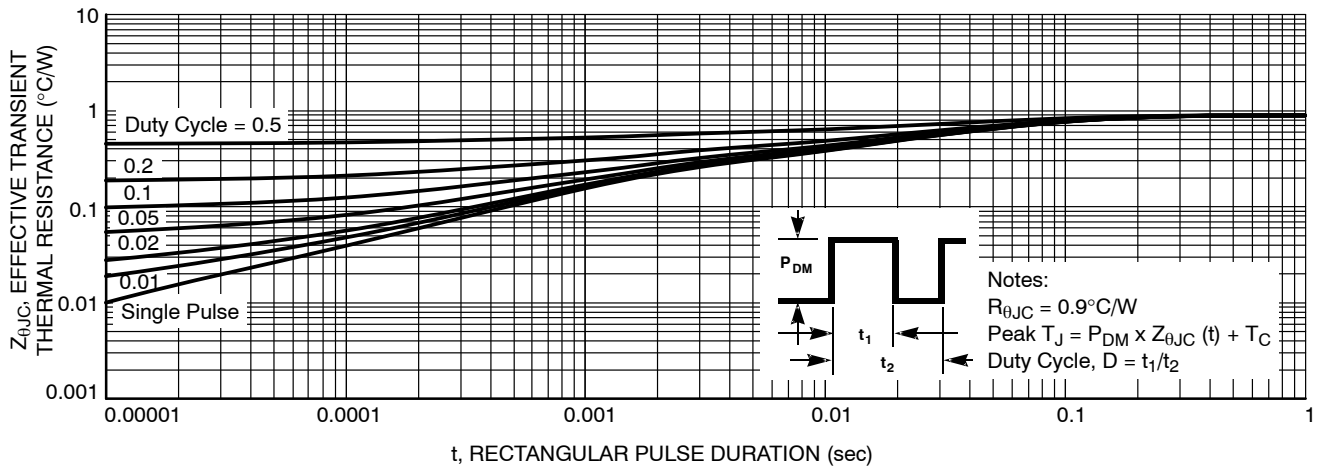
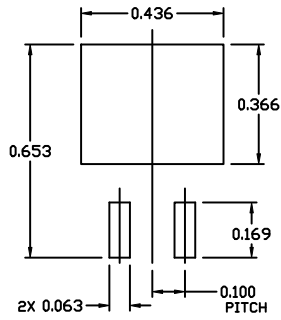

Figure 13. Transient Thermal Impedance

NTB7D3N15MC

PACKAGE DIMENSIONS

D²PAK-3 (TO-263, 3-LEAD) CASE 418AJ ISSUE E



RECOMMENDED MOUNTING FOOTPRINT

For additional information on our Pb-Free strategy and soldering details, please download the ON Semiconductor Soldering and Mounting Techniques Reference Manual, SOLDERM/T.

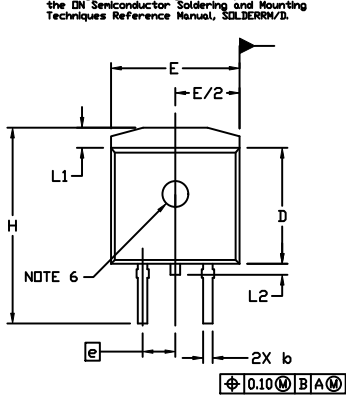

NOTES:

- DIMENSIONING AND TOLERANCING PER ASME Y14.5M, 2009.
- CONTROLLING DIMENSION: INCHES
- CHAMFER OPTIONAL.
- DIMENSIONS D AND E DO NOT INCLUDE MOLD FLASH. MOLD FLASH SHALL NOT EXCEED 0.005 PER SIDE. THESE DIMENSIONS ARE MEASURED AT THE OUTERMOST EXTREMES OF THE PLASTIC BODY AT DATUM H.
- THERMAL PAD CONTOUR IS OPTIONAL WITHIN DIMENSIONS E, L1, D1, AND E1.
- OPTIONAL MOLD FEATURE.
- ①, ② ... OPTIONAL CONSTRUCTION FEATURE CALL OUTS.

DIM	INCHES		MILLIMETERS	
	MIN.	MAX.	MIN.	MAX.
A	0.160	0.190	4.06	4.83
A1	0.000	0.010	0.00	0.25
b	0.020	0.039	0.51	0.99
c	0.012	0.029	0.30	0.74
c2	0.045	0.065	1.14	1.65
D	0.330	0.380	8.38	9.65
D1	0.260	---	6.60	---
E	0.380	0.420	9.65	10.67
E1	0.245	---	6.22	---
e	0.100	BSC	2.54	BSC
H	0.575	0.625	14.60	15.88
L	0.070	0.110	1.78	2.79
L1	---	0.066	---	1.68
L2	---	0.070	---	1.78
L3	0.010	BSC	0.25	BSC
M	-8°	8°	-8°	8°

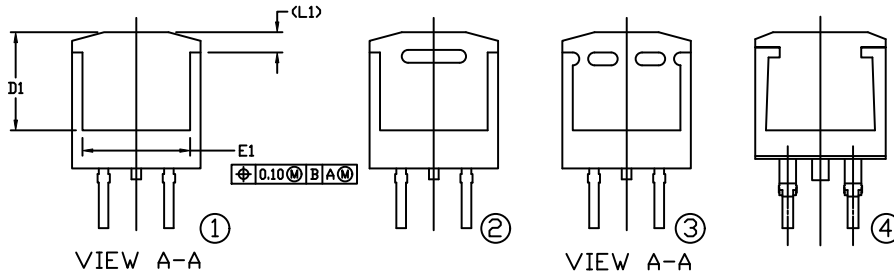
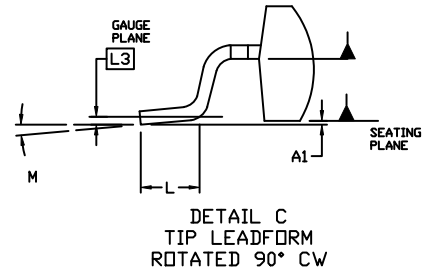
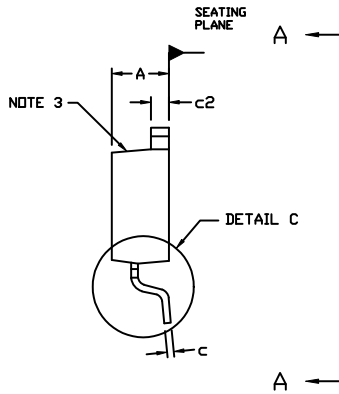

OPTIONAL CONSTRUCTIONS

ON Semiconductor and are trademarks of Semiconductor Components Industries, LLC dba ON Semiconductor or its subsidiaries in the United States and/or other countries. ON Semiconductor owns the rights to a number of patents, trademarks, copyrights, trade secrets, and other intellectual property. A listing of ON Semiconductor's product/patent coverage may be accessed at www.onsemi.com/site/pdf/Patent-Marking.pdf. ON Semiconductor reserves the right to make changes without further notice to any products herein. ON Semiconductor makes no warranty, representation or guarantee regarding the suitability of its products for any particular purpose, nor does ON Semiconductor assume any liability arising out of the application or use of any product or circuit, and specifically disclaims any and all liability, including without limitation special, consequential or incidental damages. Buyer is responsible for its products and applications using ON Semiconductor products, including compliance with all laws, regulations and safety requirements or standards, regardless of any support or applications information provided by ON Semiconductor. "Typical" parameters which may be provided in ON Semiconductor data sheets and/or specifications can and do vary in different applications and actual performance may vary over time. All operating parameters, including "Typicals" must be validated for each customer application by customer's technical experts. ON Semiconductor does not convey any license under its patent rights nor the rights of others. ON Semiconductor products are not designed, intended, or authorized for use as a critical component in life support systems or any FDA Class 3 medical devices or medical devices with a same or similar classification in a foreign jurisdiction or any devices intended for implantation in the human body. Should Buyer purchase or use ON Semiconductor products for any such unintended or unauthorized application, Buyer shall indemnify and hold ON Semiconductor and its officers, employees, subsidiaries, affiliates, and distributors harmless against all claims, costs, damages, and expenses, and reasonable attorney fees arising out of, directly or indirectly, any claim of personal injury or death associated with such unintended or unauthorized use, even if such claim alleges that ON Semiconductor was negligent regarding the design or manufacture of the part. ON Semiconductor is an Equal Opportunity/Affirmative Action Employer. This literature is subject to all applicable copyright laws and is not for resale in any manner.

PUBLICATION ORDERING INFORMATION

LITERATURE FULFILLMENT:
Email Requests to: orderlit@onsemi.com

TECHNICAL SUPPORT
North American Technical Support:
Voice Mail: 1 800-282-9855 Toll Free USA/Canada
Phone: 011 421 33 790 2910

Europe, Middle East and Africa Technical Support:
Phone: 00421 33 790 2910
For additional information, please contact your local Sales Representative

ON Semiconductor Website: www.onsemi.com