

ON Semiconductor

Is Now

onsemi™

To learn more about onsemi™, please visit our website at
www.onsemi.com

onsemi and **onsemi** and other names, marks, and brands are registered and/or common law trademarks of Semiconductor Components Industries, LLC dba "**onsemi**" or its affiliates and/or subsidiaries in the United States and/or other countries. **onsemi** owns the rights to a number of patents, trademarks, copyrights, trade secrets, and other intellectual property. A listing of **onsemi** product/patent coverage may be accessed at www.onsemi.com/site/pdf/Patent-Marking.pdf. **onsemi** reserves the right to make changes at any time to any products or information herein, without notice. The information herein is provided "as-is" and **onsemi** makes no warranty, representation or guarantee regarding the accuracy of the information, product features, availability, functionality, or suitability of its products for any particular purpose, nor does **onsemi** assume any liability arising out of the application or use of any product or circuit, and specifically disclaims any and all liability, including without limitation special, consequential or incidental damages. Buyer is responsible for its products and applications using **onsemi** products, including compliance with all laws, regulations and safety requirements or standards, regardless of any support or applications information provided by **onsemi**. "Typical" parameters which may be provided in **onsemi** data sheets and/or specifications can and do vary in different applications and actual performance may vary over time. All operating parameters, including "Typicals" must be validated for each customer application by customer's technical experts. **onsemi** does not convey any license under any of its intellectual property rights nor the rights of others. **onsemi** products are not designed, intended, or authorized for use as a critical component in life support systems or any FDA Class 3 medical devices or medical devices with a same or similar classification in a foreign jurisdiction or any devices intended for implantation in the human body. Should Buyer purchase or use **onsemi** products for any such unintended or unauthorized application, Buyer shall indemnify and hold **onsemi** and its officers, employees, subsidiaries, affiliates, and distributors harmless against all claims, costs, damages, and expenses, and reasonable attorney fees arising out of, directly or indirectly, any claim of personal injury or death associated with such unintended or unauthorized use, even if such claim alleges that **onsemi** was negligent regarding the design or manufacture of the part. **onsemi** is an Equal Opportunity/Affirmative Action Employer. This literature is subject to all applicable copyright laws and is not for resale in any manner. Other names and brands may be claimed as the property of others.

MBRS320P, MBR330P, MBRS340P

Surface Mount Schottky Power Rectifier

These devices employ the Schottky Barrier principle in a large area metal-to-silicon power diode. State-of-the-art geometry features epitaxial construction with oxide passivation and metal overlay contact. Ideally suited for low voltage, high frequency rectification, or as free wheeling and polarity protection diodes, in surface mount applications where compact size and weight are critical to the system.

Features

- Small Compact Surface Mountable Package with J-Bend Leads
- Rectangular Package for Automated Handling
- Highly Stable Oxide Passivated Junction
- Very Low Forward Voltage Drop
(0.5 V Max @ 3.0 A, $T_J = 25^\circ\text{C}$)
- Excellent Ability to Withstand Reverse Avalanche Energy Transients
- Guard-Ring for Stress Protection
- Device Passes ISO 7637 Pulse #1
- These Devices are Pb-Free, Halogen Free/BFR Free and are RoHS Compliant

Mechanical Characteristics

- Case: Epoxy, Molded, Epoxy Meets UL 94 V-0
- Weight: 217 mg (Approximately)
- Finish: All External Surfaces Corrosion Resistant and Terminal Leads are Readily Solderable
- Lead and Mounting Surface Temperature for Soldering Purposes: 260°C Max. for 10 Seconds
- Cathode Polarity Band
- Device Meets MSL 1 Requirements
- ESD Ratings:
 - ◆ Machine Model = C (> 400 V)
 - ◆ Human Body Model = 3B (> 8000 V)



ON Semiconductor®

www.onsemi.com

**SCHOTTKY BARRIER
RECTIFIERS
3.0 AMPERES
20, 30, 40 VOLTS**



SMC 2-LEAD
CASE 403AC

MARKING DIAGRAM

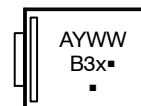

B3x = Device Code
x = 2, 3 or 4
A = Assembly Location*
Y = Year
WW = Work Week
▪ = Pb-Free Package

(Note: Microdot may be in either location)

* The Assembly Location code (A) is front side optional. In cases where the Assembly Location is stamped in the package, the front side assembly code may be blank.

ORDERING INFORMATION

Device	Package	Shipping†
MBRS320PT3G	SMC 2-Lead (Pb-Free)	2,500 / Tape & Reel
MBRS330PT3G	SMC 2-Lead (Pb-Free)	2,500 / Tape & Reel
MBRS340PT3G	SMC 2-Lead (Pb-Free)	2,500 / Tape & Reel

†For information on tape and reel specifications, including part orientation and tape sizes, please refer to our Tape and Reel Packaging Specification Brochure, BRD8011/D.

MBRS320P, MBRS330P, MBRS340P

MAXIMUM RATINGS

Rating	Symbol	MBRS320PT3G	MBRS330PT3G	MBRS340PT3G	Unit
Peak Repetitive Reverse Voltage Working Peak Reverse Voltage DC Blocking Voltage	V_{RRM} V_{RWM} V_R	20	30	40	V
Average Rectified Forward Current	$I_{F(AV)}$	3.0 @ $T_L = 110^\circ\text{C}$ 4.0 @ $T_L = 105^\circ\text{C}$			A
Nonrepetitive Peak Surge Current (Surge applied at rated load conditions halfwave, single phase, 60 Hz)	I_{FSM}	80			A
Operating Junction Temperature	T_J	- 65 to +150			$^\circ\text{C}$
ISO 7637 Pulse #1 (100 V, 10 Ω)		5000			Pulses
ESD Ratings: Machine Model = C Human Body Model = 3B		> 400 > 8000			V

Stresses exceeding those listed in the Maximum Ratings table may damage the device. If any of these limits are exceeded, device functionality should not be assumed, damage may occur and reliability may be affected.

THERMAL CHARACTERISTICS

Thermal Resistance, Junction-to-Lead	$R_{\theta JL}$	11	$^\circ\text{C}/\text{W}$
--------------------------------------	-----------------	----	---------------------------

ELECTRICAL CHARACTERISTICS

Maximum Instantaneous Forward Voltage (Note 1) ($i_F = 3.0\text{ A}$, $T_J = 25^\circ\text{C}$)	V_F	0.50	V
Maximum Instantaneous Reverse Current (Note 1) (Rated dc Voltage, $T_J = 25^\circ\text{C}$) (Rated dc Voltage, $T_J = 100^\circ\text{C}$)	i_R	2.0 20	mA

Product parametric performance is indicated in the Electrical Characteristics for the listed test conditions, unless otherwise noted. Product performance may not be indicated by the Electrical Characteristics if operated under different conditions.

1. Pulse Test: Pulse Width = 300 μs , Duty Cycle $\leq 2.0\%$.

TYPICAL ELECTRICAL CHARACTERISTICS

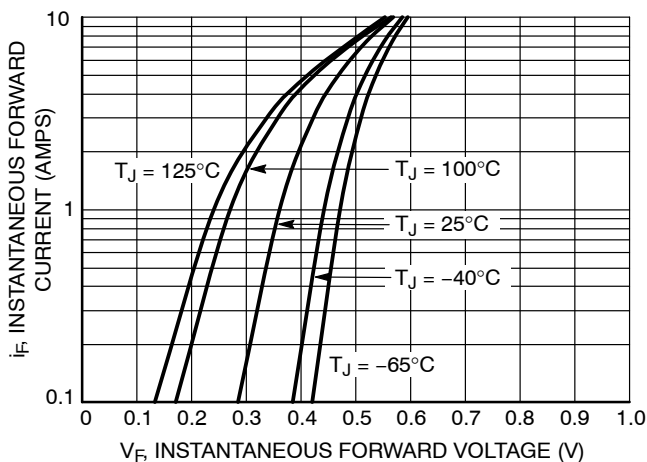

Figure 1. Typical Forward Voltage

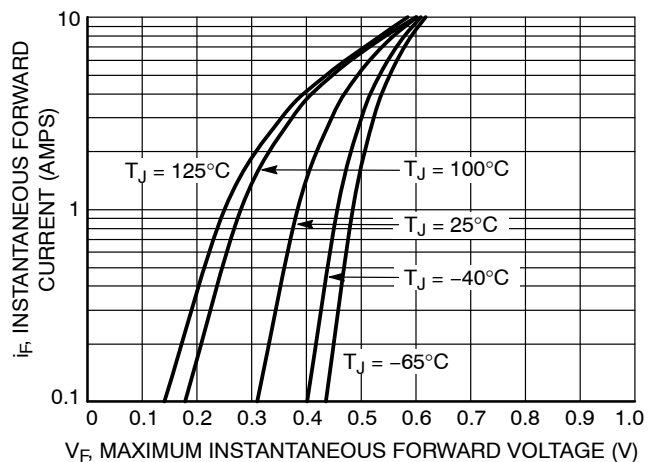

Figure 2. Maximum Forward Voltage

MBRS320P, MBRS330P, MBRS340P

TYPICAL ELECTRICAL CHARACTERISTICS (continued)

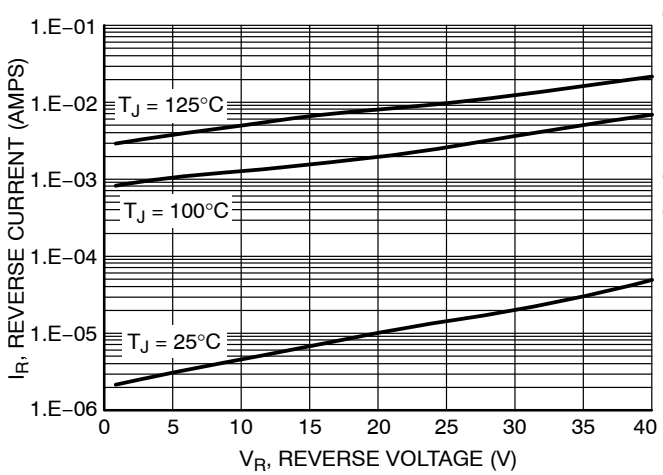

Figure 3. Typical Reverse Current

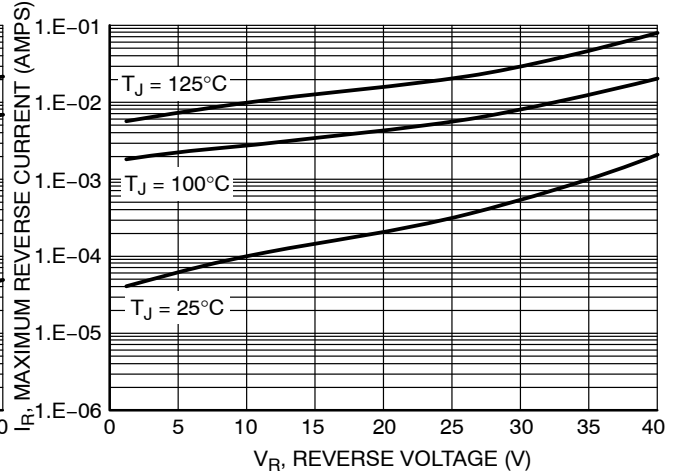

Figure 4. Maximum Reverse Current

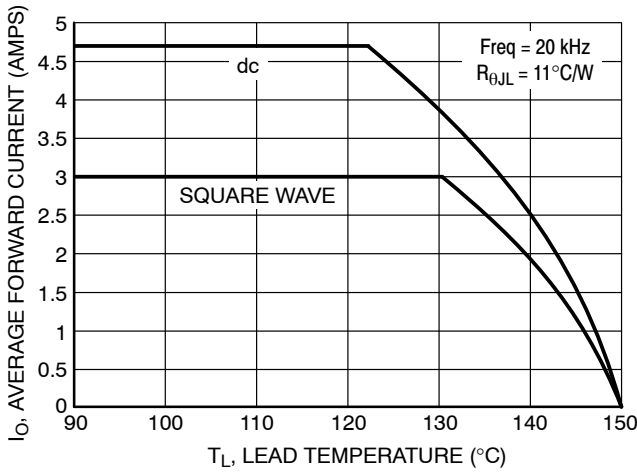

Figure 5. Current Derating

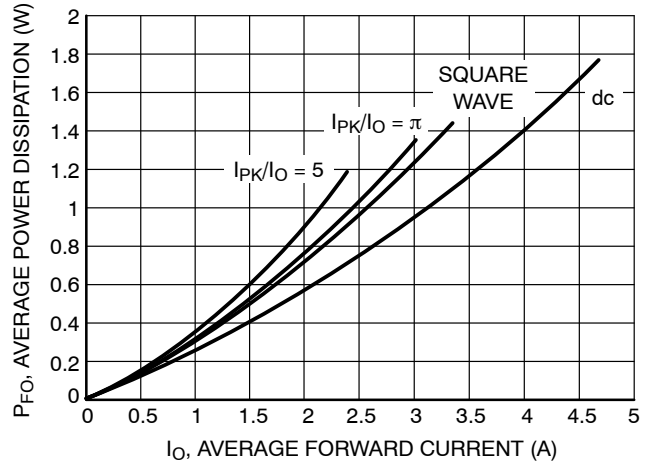

Figure 6. Forward Power Dissipation

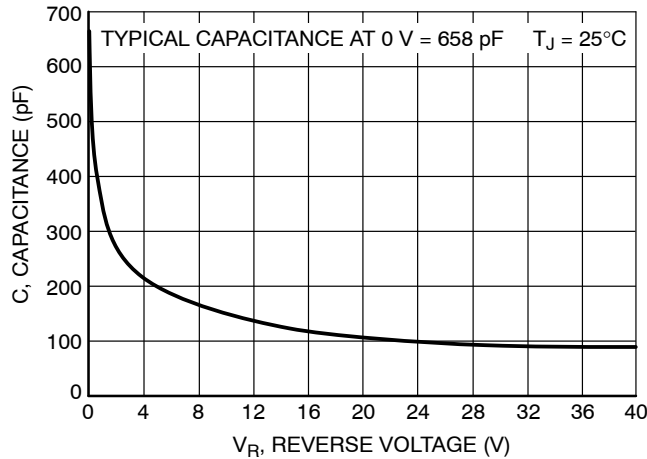

Figure 7. Typical Capacitance

MECHANICAL CASE OUTLINE

PACKAGE DIMENSIONS

ON Semiconductor®



SCALE 1:1

SMC 2-LEAD
CASE 403AC
ISSUE B

DATE 27 JUL 2017

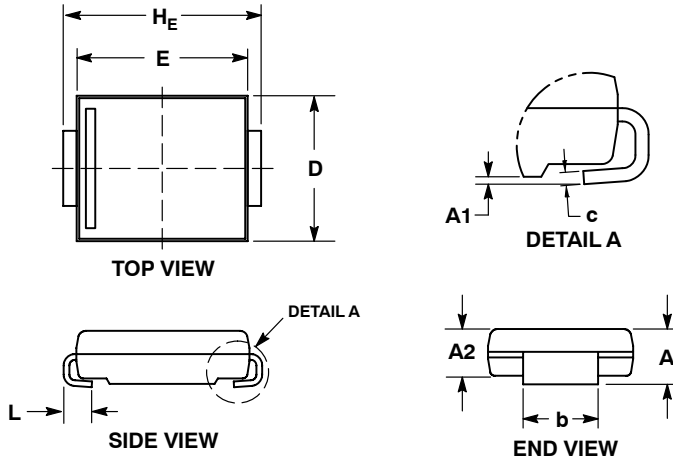

NOTES:

1. DIMENSIONING AND TOLERANCING PER ANME Y14.5M, 1994.
2. CONTROLLING DIMENSION: INCHES.
3. DIMENSIONS D AND E DO NOT INCLUDE MOLD FLASH. MOLD FLASH SHALL NOT EXCEED 0.254mm PER SIDE.
4. DIMENSIONS D AND E TO BE DETERMINED AT DATUM H.
5. DIMENSION b SHALL BE MEASURED WITHIN THE AREA DETERMINED BY DIMENSION L.

DIM	MILLIMETERS		INCHES	
	MIN	MAX	MIN	MAX
A	1.95	2.61	0.077	0.103
A1	0.05	0.20	0.002	0.008
A2	1.90	2.41	0.075	0.095
b	2.90	3.20	0.114	0.126
c	0.15	0.41	0.006	0.016
D	5.55	6.25	0.219	0.246
E	6.60	7.15	0.260	0.281
HE	7.75	8.15	0.305	0.321
L	0.75	1.60	0.030	0.063

GENERIC MARKING DIAGRAM*

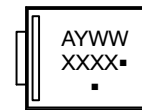

- XXXX = Specific Device Code
- A = Assembly Location
- Y = Year
- WW = Work Week
- = Pb-Free Package

(Note: Microdot may be in either location)

*This information is generic. Please refer to device data sheet for actual part marking. Pb-Free indicator, "G" or microdot "■", may or may not be present.

RECOMMENDED SOLDERING FOOTPRINT*

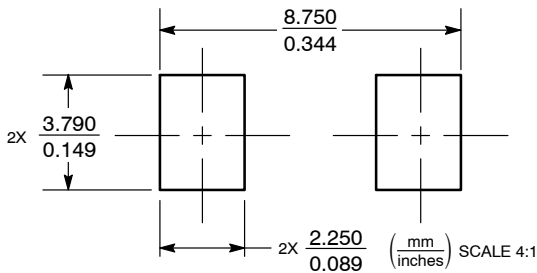

*For additional information on our Pb-Free strategy and soldering details, please download the ON Semiconductor Soldering and Mounting Techniques Reference Manual, SOLDERRM/D.

DOCUMENT NUMBER:	98AON97675F	Electronic versions are uncontrolled except when accessed directly from the Document Repository. Printed versions are uncontrolled except when stamped "CONTROLLED COPY" in red.
DESCRIPTION:	SMC 2-LEAD	PAGE 1 OF 1

ON Semiconductor and are trademarks of Semiconductor Components Industries, LLC dba ON Semiconductor or its subsidiaries in the United States and/or other countries. ON Semiconductor reserves the right to make changes without further notice to any products herein. ON Semiconductor makes no warranty, representation or guarantee regarding the suitability of its products for any particular purpose, nor does ON Semiconductor assume any liability arising out of the application or use of any product or circuit, and specifically disclaims any and all liability, including without limitation special, consequential or incidental damages. ON Semiconductor does not convey any license under its patent rights nor the rights of others.

ON Semiconductor and  are trademarks of Semiconductor Components Industries, LLC dba ON Semiconductor or its subsidiaries in the United States and/or other countries. ON Semiconductor owns the rights to a number of patents, trademarks, copyrights, trade secrets, and other intellectual property. A listing of ON Semiconductor's product/patent coverage may be accessed at www.onsemi.com/site/pdf/Patent-Marking.pdf. ON Semiconductor reserves the right to make changes without further notice to any products herein. ON Semiconductor makes no warranty, representation or guarantee regarding the suitability of its products for any particular purpose, nor does ON Semiconductor assume any liability arising out of the application or use of any product or circuit, and specifically disclaims any and all liability, including without limitation special, consequential or incidental damages. Buyer is responsible for its products and applications using ON Semiconductor products, including compliance with all laws, regulations and safety requirements or standards, regardless of any support or applications information provided by ON Semiconductor. "Typical" parameters which may be provided in ON Semiconductor data sheets and/or specifications can and do vary in different applications and actual performance may vary over time. All operating parameters, including "Typicals" must be validated for each customer application by customer's technical experts. ON Semiconductor does not convey any license under its patent rights nor the rights of others. ON Semiconductor products are not designed, intended, or authorized for use as a critical component in life support systems or any FDA Class 3 medical devices or medical devices with a same or similar classification in a foreign jurisdiction or any devices intended for implantation in the human body. Should Buyer purchase or use ON Semiconductor products for any such unintended or unauthorized application, Buyer shall indemnify and hold ON Semiconductor and its officers, employees, subsidiaries, affiliates, and distributors harmless against all claims, costs, damages, and expenses, and reasonable attorney fees arising out of, directly or indirectly, any claim of personal injury or death associated with such unintended or unauthorized use, even if such claim alleges that ON Semiconductor was negligent regarding the design or manufacture of the part. ON Semiconductor is an Equal Opportunity/Affirmative Action Employer. This literature is subject to all applicable copyright laws and is not for resale in any manner.

PUBLICATION ORDERING INFORMATION

LITERATURE FULFILLMENT:

Email Requests to: orderlit@onsemi.com

ON Semiconductor Website: www.onsemi.com

TECHNICAL SUPPORT

North American Technical Support:
Voice Mail: 1 800-282-9855 Toll Free USA/Canada
Phone: 011 421 33 790 2910

Europe, Middle East and Africa Technical Support:

Phone: 00421 33 790 2910

For additional information, please contact your local Sales Representative

