

Double channel high-side driver

Features

Type	$R_{DS(on)}$	I_{OUT}	V_{CC}
VND810SP	160 m Ω ⁽¹⁾	3.5 A ⁽¹⁾	36 V

1. Per each channel.

- Very low standby current
- CMOS compatible input
- On-state open-load detection
- Off-state open-load detection
- Thermal shutdown protection and diagnosis
- Undervoltage shutdown
- Overvoltage clamp
- Output stuck to V_{CC} detection
- Load current limitation
- Reverse battery protection
- Electrostatic discharge protection

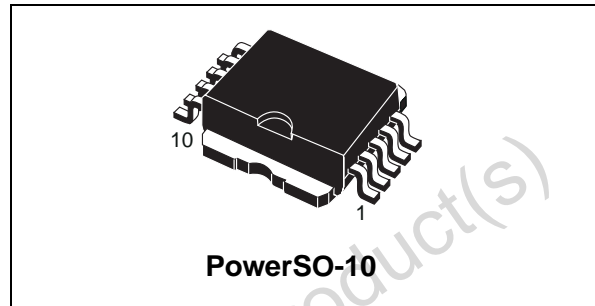

Description

The VND810SP is a monolithic device designed using STMicroelectronics™ VIPower™ M0-3 Technology. The VND810SP is intended for driving any type of multiple load with one side connected to ground.

The Active V_{CC} pin voltage clamp protects the device against low energy spikes (see ISO7637 transient compatibility table). Active current limitation combined with thermal shutdown and automatic restart protects the device against overload.

The device detects the open-load condition in both the on-state and off-state. In the off-state the device detects if the output is shorted to V_{CC} . The device automatically turns off in the case where the ground pin becomes disconnected.

Table 1. Device summary

Package	Order codes	
	Tube	Tape and reel
PowerSO-10	VND810SP	VND810SP13TR

Contents

1	Block diagram and pin description	5
2	Electrical specifications	6
2.1	Absolute maximum ratings	6
2.2	Thermal data	7
2.3	Electrical characteristics	7
2.4	Electrical characteristics curves	13
3	Application information	16
3.1	GND protection network against reverse battery	16
3.1.1	Solution 1: a resistor in the ground line (RGND only)	16
3.1.2	Solution 2: a diode (D _{GND}) in the ground line	17
3.2	Load dump protection	17
3.3	MCU I/O protection	17
3.4	Open-load detection in off-state	18
3.5	Maximum demagnetization energy (V _{CC} = 13.5 V)	19
4	Package and PCB thermal data	20
4.1	PowerSO-10 thermal data	20
5	Package and packing information	23
5.1	ECOPACK [®] packages	23
5.2	PowerSO-10 mechanical data	23
5.3	PowerSO-10 packing information	25
6	Revision history	26

List of tables

Table 1.	Device summary	1
Table 2.	Suggested connections for unused and not connected pins	5
Table 3.	Absolute maximum ratings	6
Table 4.	Thermal data (per island)	7
Table 5.	Power output.	8
Table 6.	Protections	8
Table 7.	V _{CC} - output diode	9
Table 8.	Switching (V _{CC} = 13 V; T _j = 25 °C)	9
Table 9.	Logic inputs.	9
Table 10.	Status pin	9
Table 11.	Open-load detection	10
Table 12.	Truth table.	11
Table 13.	Electrical transient requirements	11
Table 14.	Thermal parameters	22
Table 15.	PowerSO-10 mechanical data	24
Table 16.	Document revision history	26

List of figures

Figure 1.	Block diagram	5
Figure 2.	Configuration diagram (top view)	5
Figure 3.	Current and voltage conventions ⁽¹⁾	7
Figure 4.	Status timings	10
Figure 5.	Switching time waveforms	10
Figure 6.	Waveforms	12
Figure 7.	Off-state output current.	13
Figure 8.	High level input current.	13
Figure 9.	Input clamp voltage.	13
Figure 10.	Turn-on voltage slope	13
Figure 11.	Overshoot shutdown	13
Figure 12.	Turn-off voltage slope	13
Figure 13.	I_{LIM} vs T_{case}	14
Figure 14.	On-state resistance vs V_{CC}	14
Figure 15.	Input high level	14
Figure 16.	Input hysteresis voltage	14
Figure 17.	On-state resistance vs T_{case}	14
Figure 18.	Input low level	14
Figure 19.	Status leakage current	15
Figure 20.	Status low output voltage	15
Figure 21.	Status clamp voltage	15
Figure 22.	Open-load on-state detection threshold	15
Figure 23.	Open-load off-state voltage detection threshold	15
Figure 24.	Application schematic	16
Figure 25.	Open-load detection in off-state	18
Figure 26.	Maximum turn-off current versus load inductance ⁽¹⁾	19
Figure 27.	PowerSO-10 PC board ⁽¹⁾	20
Figure 28.	$R_{thj-amb}$ vs PCB copper area in open box free air condition	20
Figure 29.	Thermal impedance junction ambient single pulse	21
Figure 30.	Thermal fitting model of a double channel HSD in PowerSO-10	21
Figure 31.	PowerSO-10 package dimensions	23
Figure 32.	PowerSO-10 suggested pad layout	25
Figure 33.	PowerSO-10 tube shipment (no suffix).	25
Figure 34.	PowerSO-10 tape and reel shipment (suffix "TR")	25

1 Block diagram and pin description

Figure 1. Block diagram

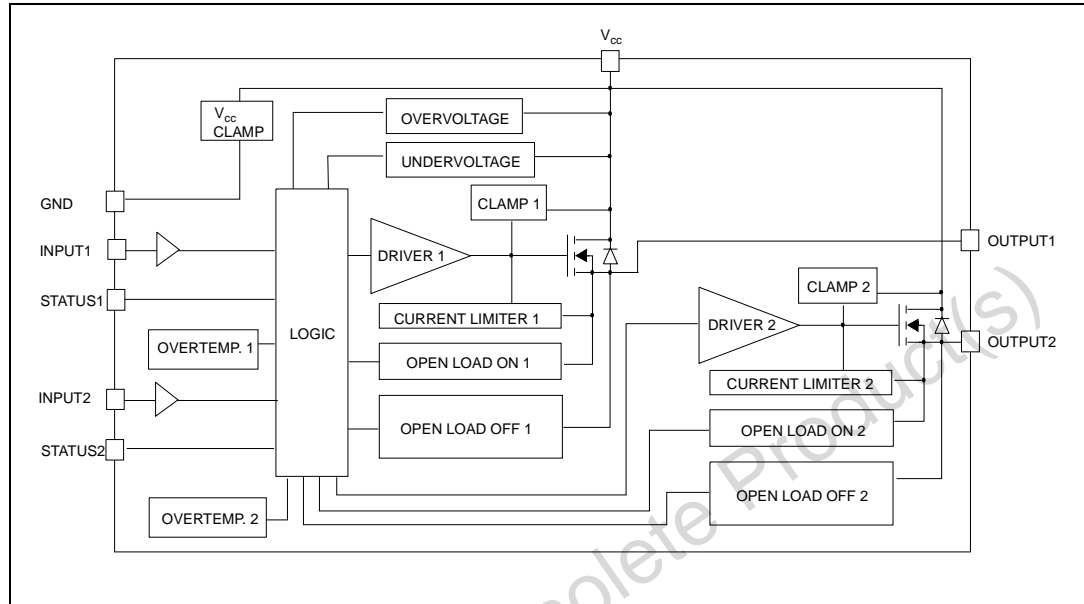

Figure 2. Configuration diagram (top view)

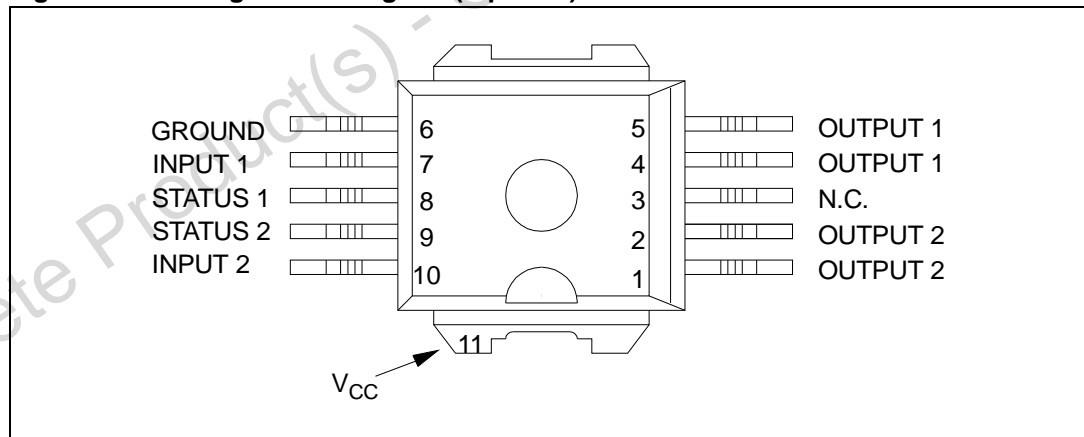

Table 2. Suggested connections for unused and not connected pins

Connection / pin	Status	N.C.	Output	Input
Floating	X	X	X	X
To ground		X		Through 10 KΩ resistor

2 Electrical specifications

2.1 Absolute maximum ratings

Stressing the device above the rating listed in the “Absolute maximum ratings” table may cause permanent damage to the device. These are stress ratings only and operation of the device at these or any other conditions above those indicated in the Operating sections of this specification is not implied. Exposure to Absolute Maximum Rating conditions for extended periods may affect device reliability. Refer also to the STMicroelectronics SURE Program and other relevant quality document.

Table 3. Absolute maximum ratings

Symbol	Parameter	Value	Unit
V_{CC}	DC supply voltage	41	V
$-V_{CC}$	Reverse DC supply voltage	- 0.3	V
$-I_{GND}$	DC reverse ground pin current	- 200	mA
I_{OUT}	DC output current	Internally limited	A
$-I_{OUT}$	Reverse DC output current	- 6	A
I_{IN}	DC input current	+/- 10	mA
I_{STAT}	DC Status current	+/- 10	mA
V_{ESD}	Electrostatic discharge (human body model: R = 1.5 K Ω ; C = 100 pF)		
	– INPUT	4000	V
	– STATUS	4000	V
	– OUTPUT	5000	V
	– V_{CC}	5000	V
E_{MAX}	Maximum switching energy (L = 1.4 mH; R _L = 0 Ω ; V _{bat} = 13.5 V; T _{jstart} = 150 °C; I _L = 5 A)	24	mJ
P_{tot}	Power dissipation (per island) at T _{lead} = 25°C	52	W
T_j	Junction operating temperature	Internally limited	°C
T_c	Case operating temperature	- 40 to 150	
T_{stg}	Storage temperature	- 55 to 150	°C

2.2 Thermal data

Table 4. Thermal data (per island)

Symbol	Parameter	Value		Unit
$R_{thj-case}$	Thermal resistance junction-case	2.4		°C/W
$R_{thj-amb}$	Thermal resistance junction-ambient	52.4 ⁽¹⁾	37 ⁽²⁾	°C/W

1. When mounted on a standard single-sided FR-4 board with 0.5 cm² of Cu (at least 35 μm thick) connected to all V_{CC} pins. Horizontal mounting and no artificial air flow.
2. When mounted on a standard single-sided FR-4 board with 6 cm² of Cu (at least 35 μm thick) connected to all V_{CC} pins. Horizontal mounting and no artificial air flow.

2.3 Electrical characteristics

Values specified in this section are for 8 V < V_{CC} < 36 V; -40 °C < T_j < 150 °C, unless otherwise stated.

Figure 3. Current and voltage conventions⁽¹⁾

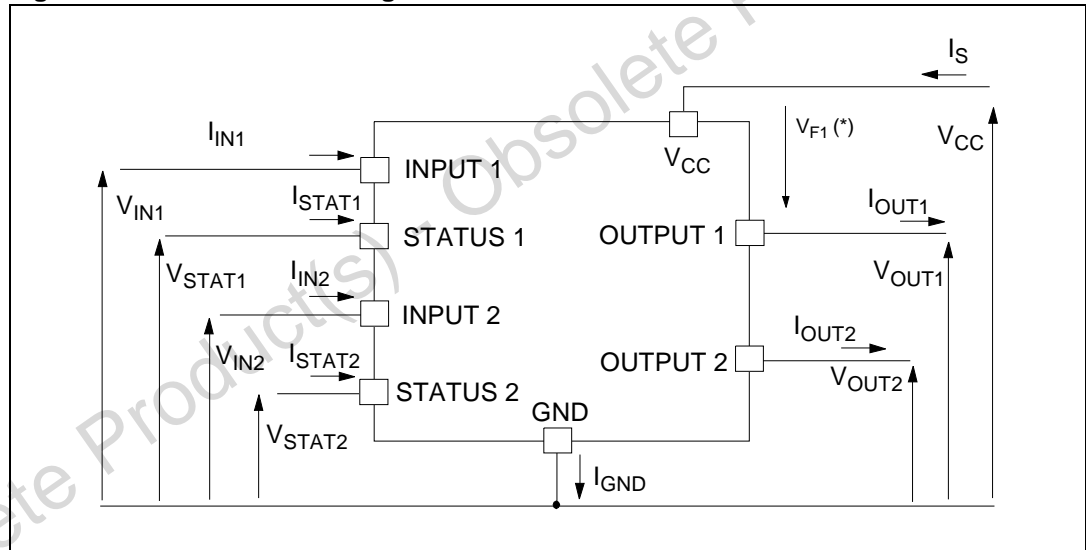

1. $V_{Fn} = V_{CCn} - V_{OUTn}$ during reverse battery condition.

Table 5. Power output

Symbol	Parameter	Test conditions	Min.	Typ.	Max.	Unit
V_{CC}	Operating supply voltage		5.5	13	36	V
V_{USD}	Undervoltage shutdown		3	4	5.5	V
V_{OV}	Overvoltage shutdown		36			V
R_{ON}	On-state resistance	$I_{OUT} = 1\text{ A}; T_j = 25\text{ °C}$			160	mΩ
		$I_{OUT} = 1\text{ A}; V_{CC} > 8\text{ V}$			320	mΩ
I_S	Supply current	Off-state; $V_{CC} = 13\text{ V}; V_{IN} = V_{OUT} = 0\text{ V}$		12	40	μA
		Off-state; $V_{CC} = 13\text{ V}; V_{IN} = V_{OUT} = 0\text{ V}; T_j = 25\text{ °C}$		12	25	μA
		On-state; $V_{CC} = 13\text{ V}; V_{IN} = 5\text{ V}; I_{OUT} = 0\text{ A}$		5	7	mA
$I_{L(off1)}$	Off-state output current	$V_{IN} = V_{OUT} = 0\text{ V}$	0		50	μA
$I_{L(off2)}$	Off-state output current	$V_{IN} = 0\text{ V}; V_{OUT} = 3.5\text{ V}$	-75		0	μA
$I_{L(off3)}$	Off-state output current	$V_{IN} = V_{OUT} = 0\text{ V}; V_{CC} = 13\text{ V}; T_j = 125\text{ °C}$			5	μA
$I_{L(off4)}$	Off-state output current	$V_{IN} = V_{OUT} = 0\text{ V}; V_{CC} = 13\text{ V}; T_j = 25\text{ °C}$			3	μA

Table 6. Protections

Symbol	Parameter	Test conditions	Min.	Typ.	Max.	Unit
T_{TSD}	Shutdown temperature		150	175	200	°C
T_R	Reset temperature		135			°C
T_{hyst}	Thermal hysteresis		7	15		°C
t_{SDL}	Status delay in overload conditions	$T_j > T_{TSD}$			20	μs
I_{lim}	Current limitation	$V_{CC} = 13\text{ V}$	3.5	5	7.5	A
		$5.5\text{ V} < V_{CC} < 36\text{ V}$			7.5	A
V_{demag}	Turn-off output clamp voltage	$I_{OUT} = 1\text{ A}; L = 6\text{ mH}$	$V_{CC} - 41$	$V_{CC} - 48$	$V_{CC} - 55$	V

Note: To ensure long term reliability under heavy overload or short circuit conditions, protection and related diagnostic signals must be used together with a proper software strategy. If the device is subjected to abnormal conditions, this software must limit the duration and number of activation cycles.

Table 7. V_{CC} - output diode

Symbol	Parameter	Test conditions	Min.	Typ.	Max.	Unit
V_F	Forward on voltage	$-I_{OUT} = 0.5 \text{ A}$; $T_j = 150 \text{ }^\circ\text{C}$	—	—	0.6	V

Table 8. Switching ($V_{CC} = 13 \text{ V}$; $T_j = 25 \text{ }^\circ\text{C}$)

Symbol	Parameter	Test conditions	Min.	Typ.	Max.	Unit
$t_{d(on)}$	Turn-on delay time	$R_L = 13 \text{ } \Omega$ from V_{IN} rising edge to $V_{OUT} = 1.3 \text{ V}$ (see Figure 5)	—	30	—	μs
$t_{d(off)}$	Turn-off delay time	$R_L = 13 \text{ } \Omega$ from V_{IN} falling edge to $V_{OUT} = 11.7 \text{ V}$ (see Figure 5)	—	30	—	μs
$dV_{OUT}/dt_{(on)}$	Turn-on voltage slope	$R_L = 13 \text{ } \Omega$ from $V_{OUT} = 1.3 \text{ V}$ to $V_{OUT} = 10.4 \text{ V}$ (see Figure 5)	—	See Figure 10	—	$\text{V}/\mu\text{s}$
$dV_{OUT}/dt_{(off)}$	Turn-off voltage slope	$R_L = 13 \text{ } \Omega$ from $V_{OUT} = 11.7 \text{ V}$ to $V_{OUT} = 1.3 \text{ V}$ (see Figure 5)	—	See Figure 12	—	$\text{V}/\mu\text{s}$

Table 9. Logic inputs

Symbol	Parameter	Test conditions	Min.	Typ.	Max.	Unit
V_{IL}	Input low level				1.25	V
I_{IL}	Low level input current	$V_{IN} = 1.25 \text{ V}$	1			μA
V_{IH}	Input high level		3.25			V
I_{IH}	High level input current	$V_{IN} = 3.25 \text{ V}$			10	μA
$V_{I(hyst)}$	Input hysteresis voltage		0.5			V
V_{ICL}	Input clamp voltage	$I_{IN} = 1 \text{ mA}$	6	6.8	8	V
		$I_{IN} = -1 \text{ mA}$		-0.7		V

Table 10. Status pin

Symbol	Parameter	Test conditions	Min.	Typ.	Max.	Unit
V_{STAT}	Status low output voltage	$I_{STAT} = 1.6 \text{ mA}$			0.5	V
I_{LSTAT}	Status leakage current	Normal operation; $V_{STAT} = 5 \text{ V}$			10	μA
C_{STAT}	Status pin Input capacitance	Normal operation; $V_{STAT} = 5 \text{ V}$			100	pF
V_{SCL}	Status clamp voltage	$I_{STAT} = 1 \text{ mA}$	6	6.8	8	V
		$I_{STAT} = -1 \text{ mA}$		-0.7		V

Table 11. Open-load detection

Symbol	Parameter	Test conditions	Min.	Typ.	Max.	Unit
I_{OL}	Open-load on-state detection threshold	$V_{IN} = 5\text{ V}$	20	40	80	mA
$t_{DOL(on)}$	Open-load on-state detection delay	$I_{OUT} = 0\text{ A}$			200	μs
V_{OL}	Open-load off-state voltage detection threshold	$V_{IN} = 0\text{ V}$	1.5	2.5	3.5	V
$t_{DOL(off)}$	Open-load detection delay at turn-off				1000	μs

Figure 4. Status timings

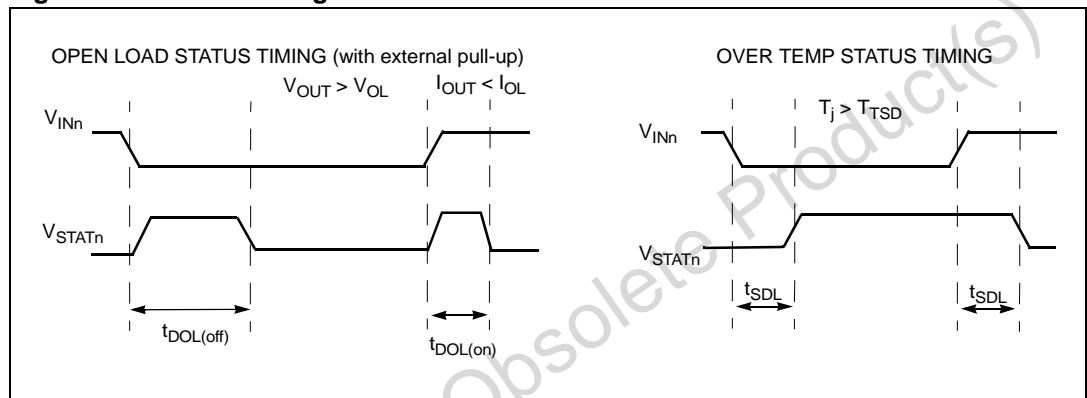

Figure 5. Switching time waveforms

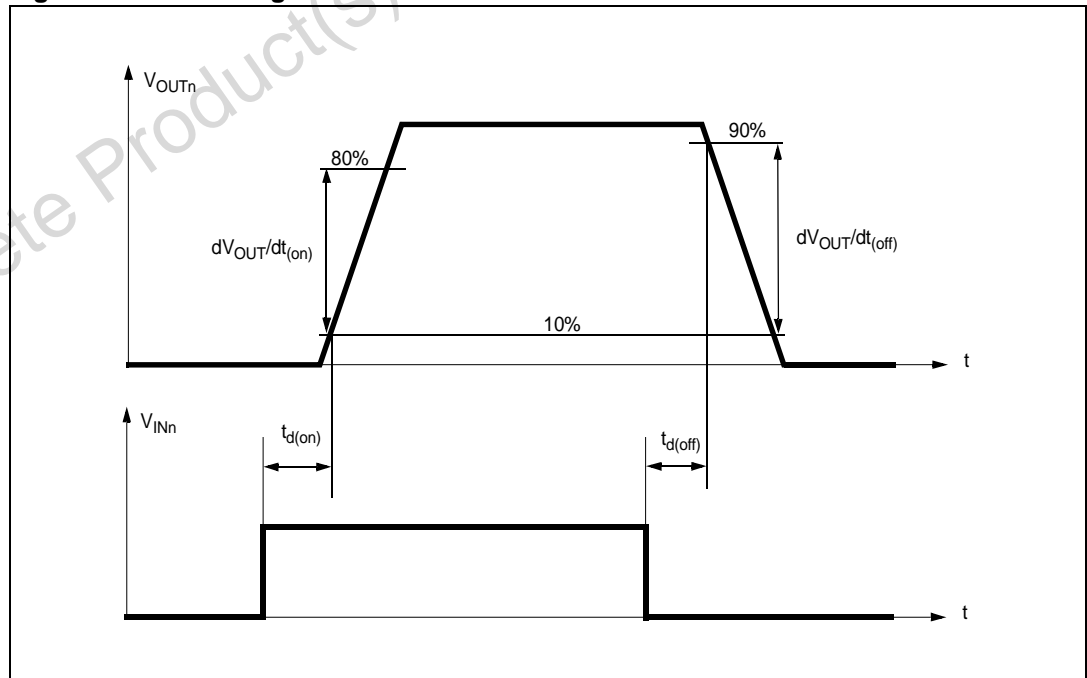

Table 12. Truth table

Conditions	Input	Output	Status
Normal operation	L	L	H
	H	H	H
Current limitation	L	L	H
	H	X	($T_j < T_{TSD}$) H ($T_j > T_{TSD}$) L
Overtemperature	L	L	H
	H	L	L
Undervoltage	L	L	X
	H	L	X
Overvoltage	L	L	H
	H	L	H
Output voltage $> V_{OL}$	L	H	L
	H	H	H
Output current $< I_{OL}$	L	L	H
	H	H	L

Table 13. Electrical transient requirements

ISO T/R 7637/1 Test pulse	Test level				Delays and impedance
	I	II	III	IV	
1	- 25V ⁽¹⁾	- 50V ⁽¹⁾	- 75V ⁽¹⁾	- 100V ⁽¹⁾	2ms, 10Ω
2	+ 25V ⁽¹⁾	+ 50V ⁽¹⁾	+ 75V ⁽¹⁾	+ 100V ⁽¹⁾	0.2ms, 10Ω
3a	- 25V ⁽¹⁾	- 50V ⁽¹⁾	- 100V ⁽¹⁾	- 150V ⁽¹⁾	0.1μs, 50Ω
3b	+ 25V ⁽¹⁾	+ 50V ⁽¹⁾	+ 75V ⁽¹⁾	+ 100V ⁽¹⁾	0.1μs, 50Ω
4	- 4V ⁽¹⁾	- 5V ⁽¹⁾	- 6V ⁽¹⁾	- 7V ⁽¹⁾	100ms, 0.01Ω
5	+ 26.5V ⁽¹⁾	+ 46.5V ⁽²⁾	+ 66.5V ⁽²⁾	+ 86.5V ⁽²⁾	400ms, 2Ω

1. All functions of the device are performed as designed after exposure to disturbance.
2. One or more functions of the device is not performed as designed after exposure and cannot be returned to proper operation without replacing the device.

Figure 6. Waveforms

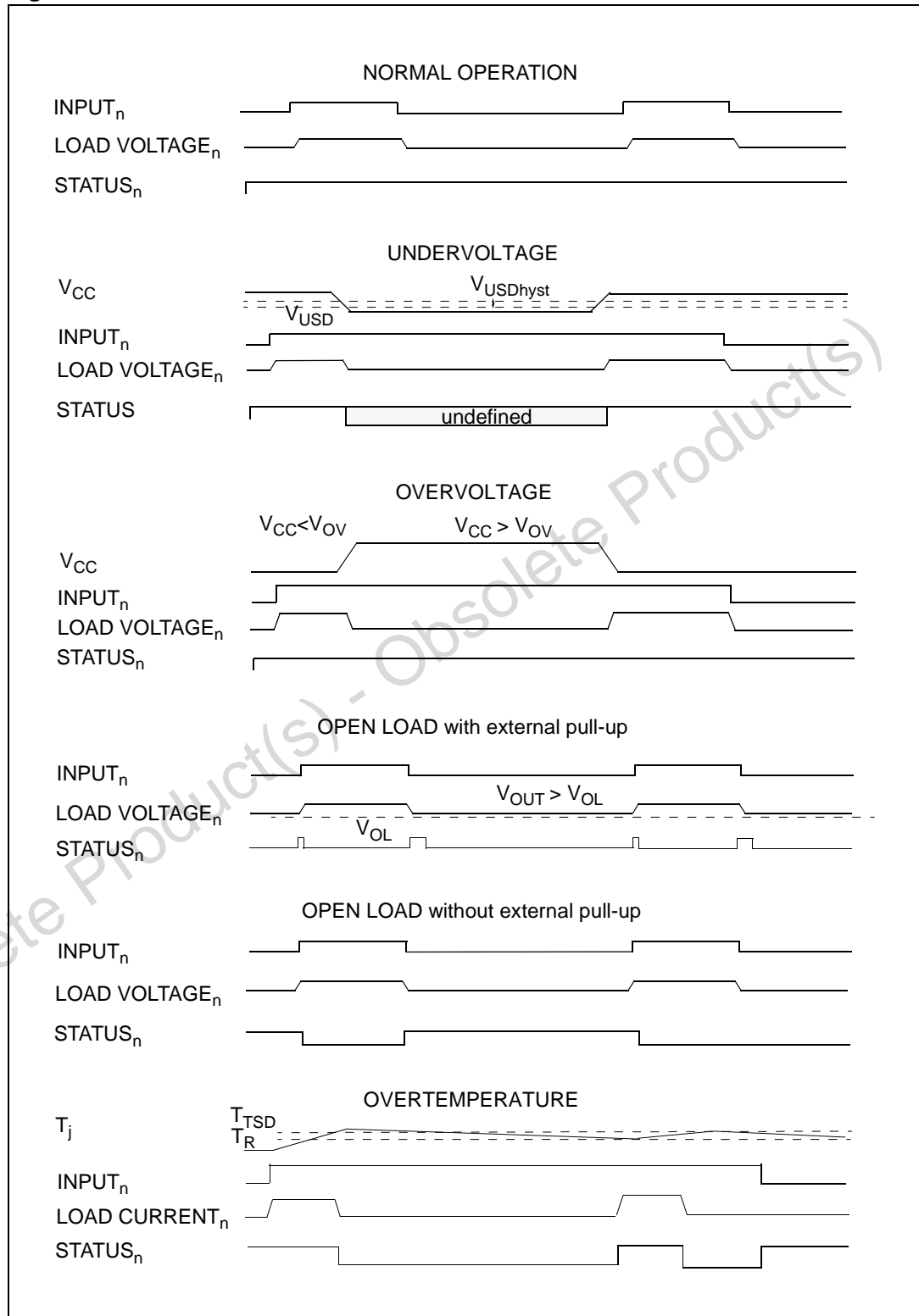

2.4 Electrical characteristics curves

Figure 7. Off-state output current

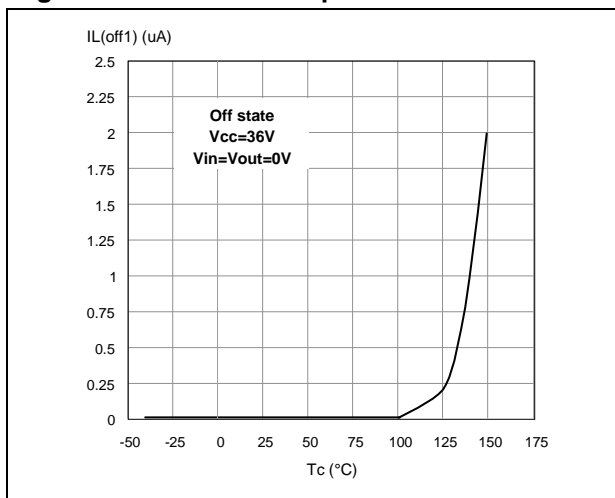

Figure 8. High level input current

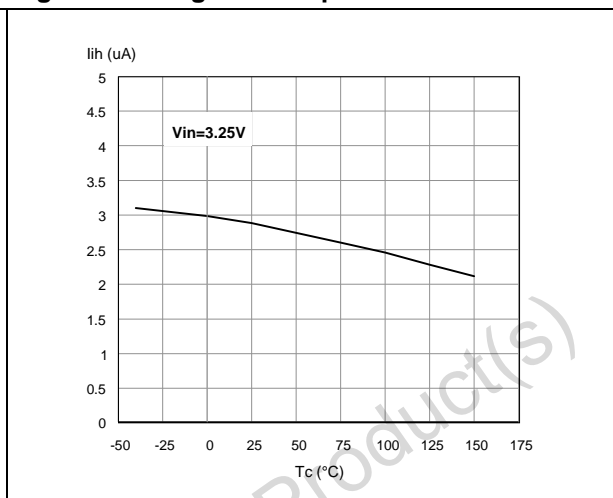

Figure 9. Input clamp voltage

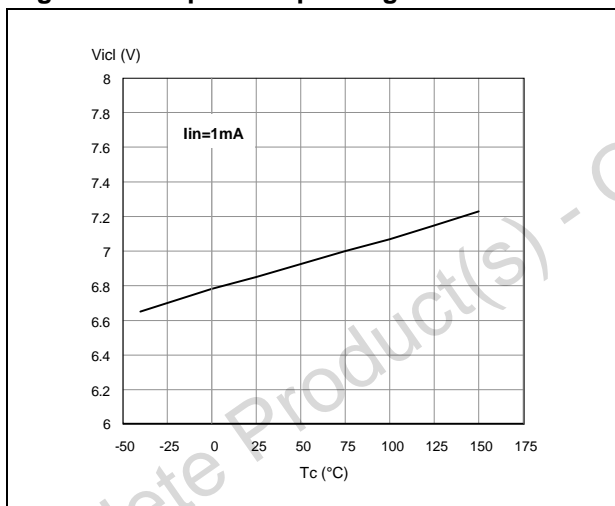

Figure 10. Turn-on voltage slope

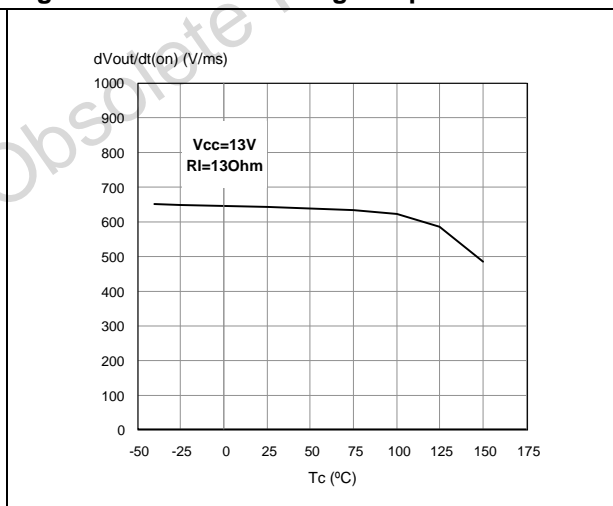

Figure 11. Overvoltage shutdown

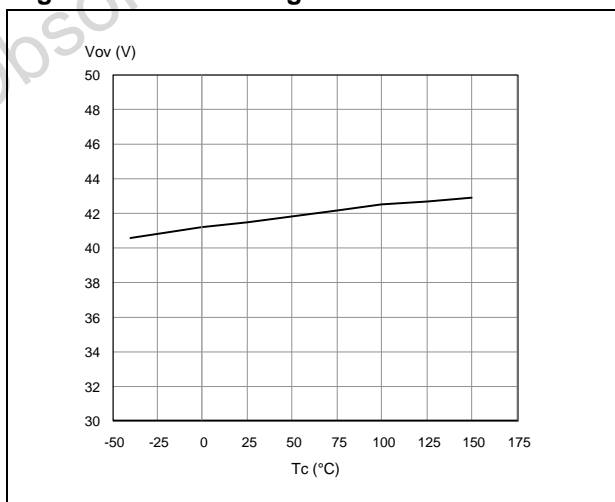

Figure 12. Turn-off voltage slope

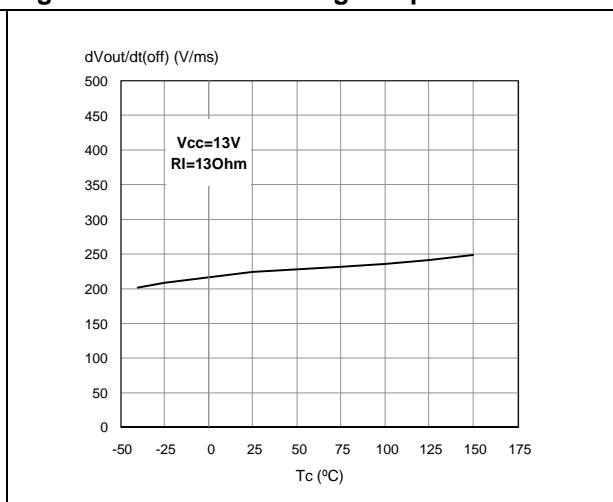

Figure 13. I_{LIM} vs T_{case}

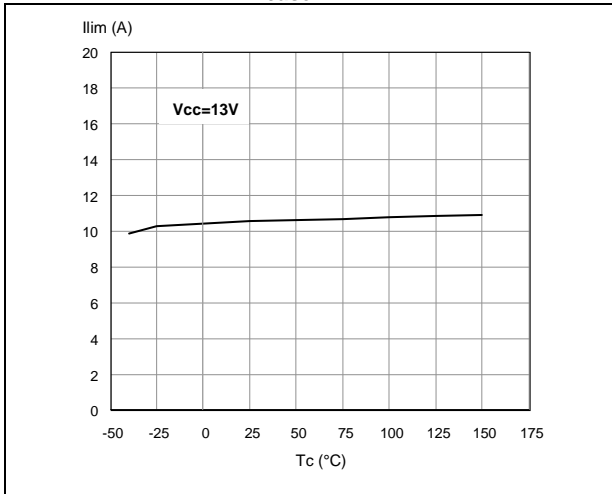

Figure 14. On-state resistance vs V_{CC}

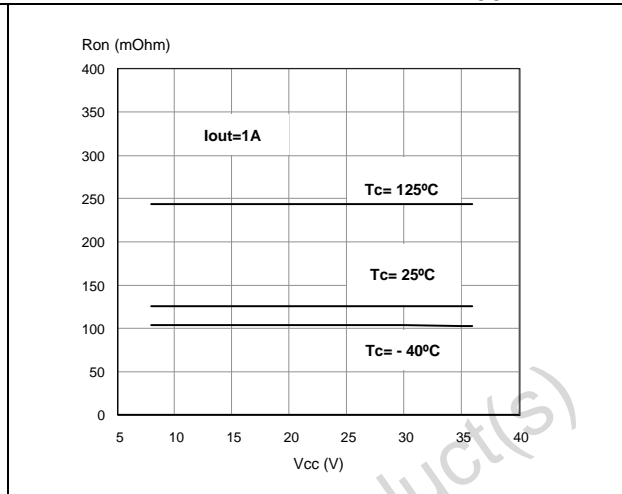

Figure 15. Input high level

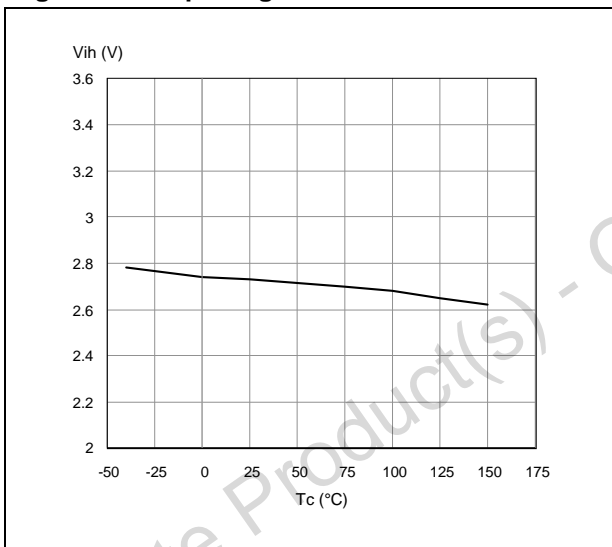

Figure 16. Input hysteresis voltage

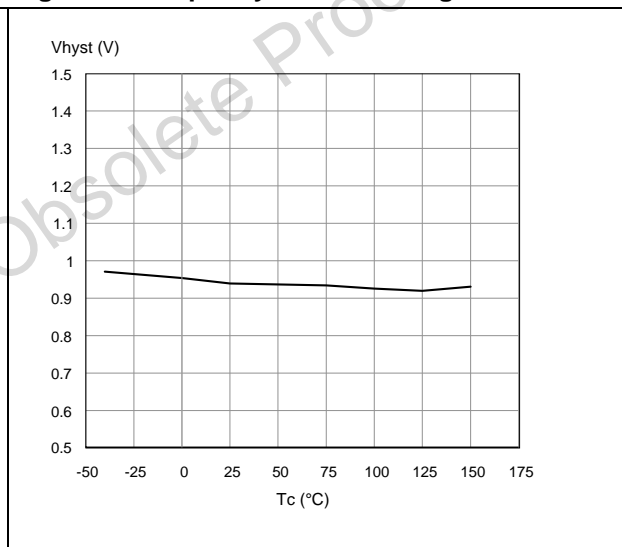

Figure 17. On-state resistance vs T_{case}

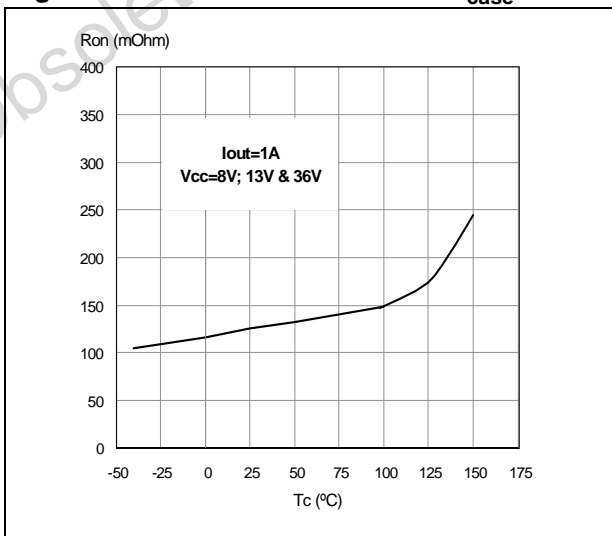

Figure 18. Input low level

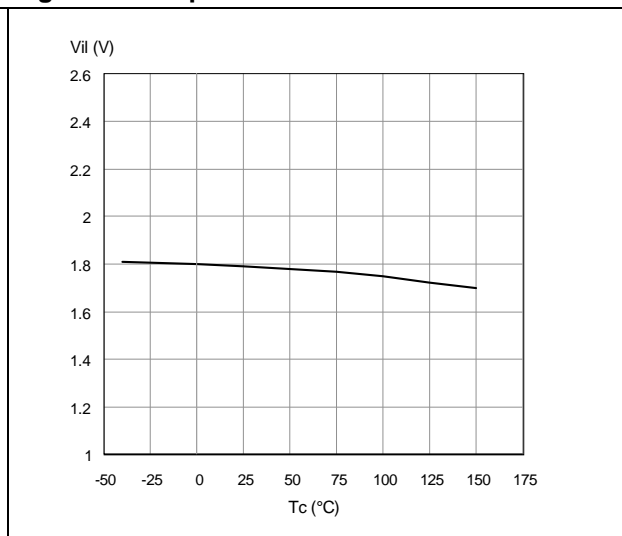

Figure 19. Status leakage current

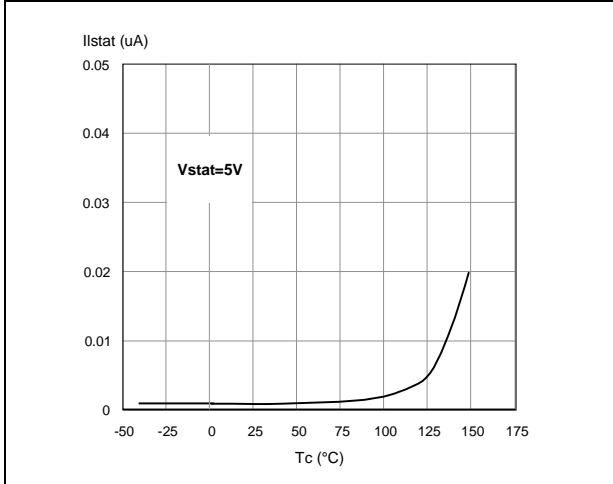

Figure 20. Status low output voltage

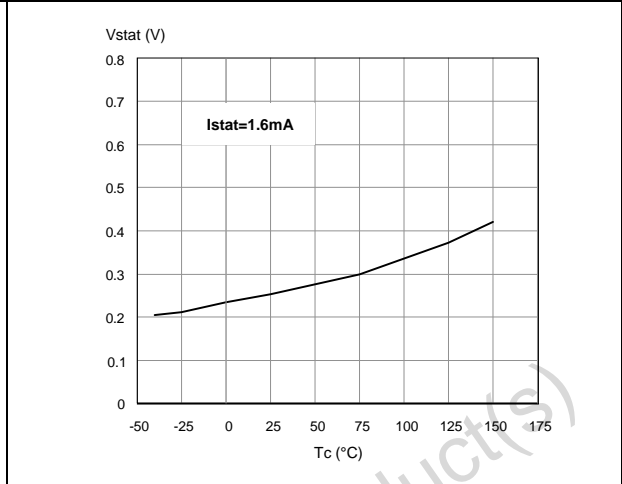

Figure 21. Status clamp voltage

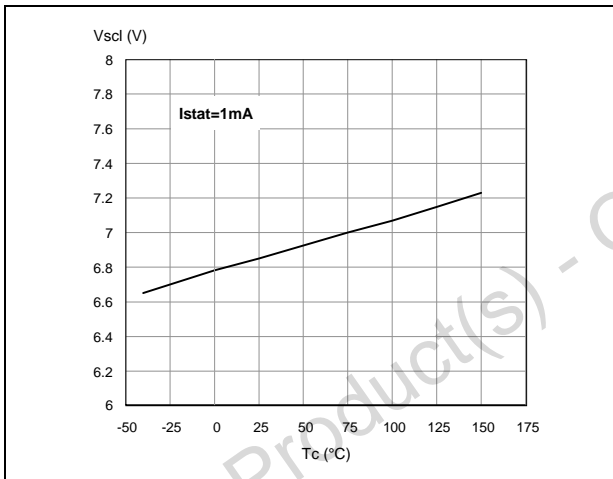

Figure 22. Open-load on-state detection threshold

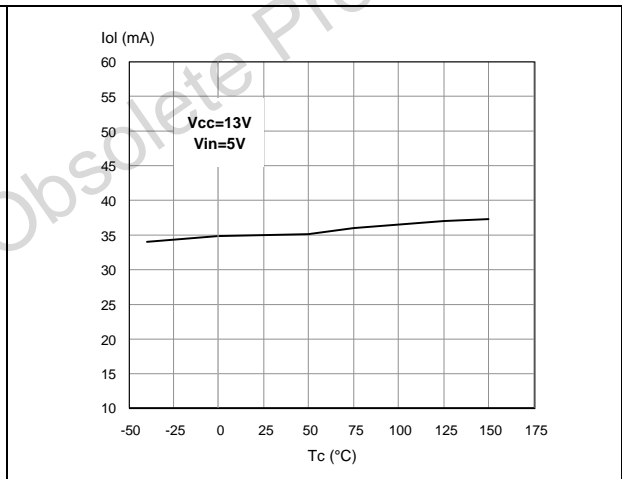
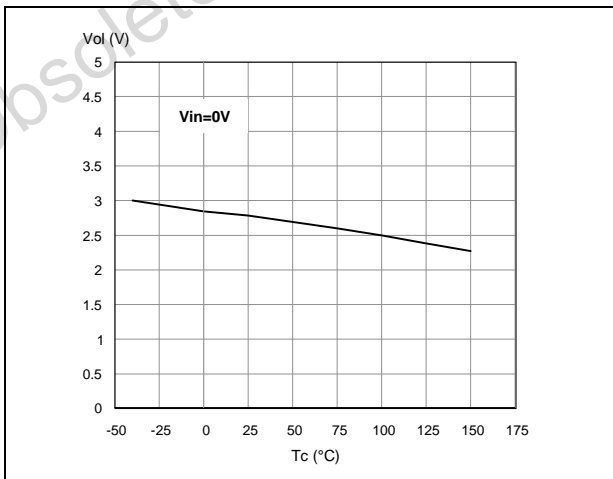
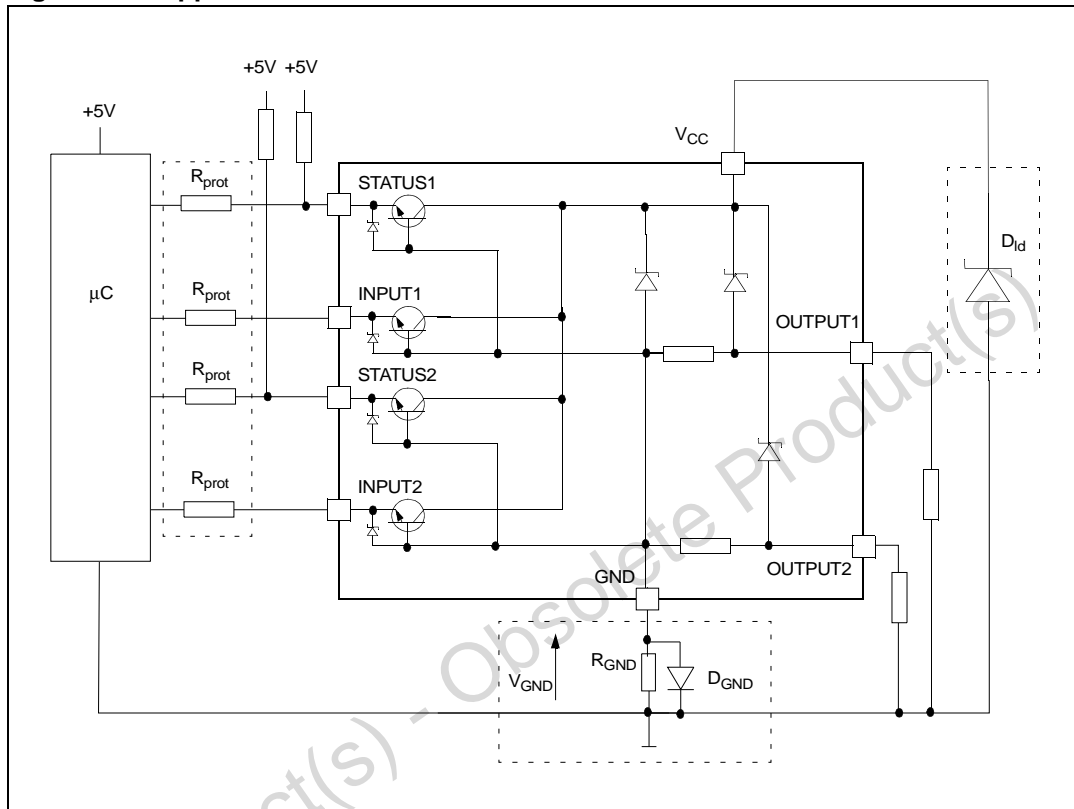

Figure 23. Open-load off-state voltage detection threshold



3 Application information

Figure 24. Application schematic



3.1 GND protection network against reverse battery

This section provides two solutions for implementing a ground protection network against reverse battery.

3.1.1 Solution 1: a resistor in the ground line (R_{GND} only)

This can be used with any type of load.

The following show how to dimension the R_{GND} resistor:

1. $R_{GND} \leq 600 \text{ mV} / 2 (I_{S(on)max})$
2. $R_{GND} \geq (-V_{CC}) / (-I_{GND})$

where - I_{GND} is the DC reverse ground pin current and can be found in the absolute maximum rating section of the device datasheet.

Power dissipation in R_{GND} (when V_{CC} < 0 during reverse battery situations) is:

$$P_D = (-V_{CC})^2 / R_{GND}$$

This resistor can be shared amongst several different HSDs. Please note that the value of this resistor should be calculated with formula (1) where I_{S(on)max} becomes the sum of the maximum on-state currents of the different devices.

Please note that, if the microprocessor ground is not shared by the device ground, then the R_{GND} will produce a shift ($I_{S(on)max} * R_{GND}$) in the input thresholds and the status output values. This shift will vary depending on how many devices are ON in the case of several high-side drivers sharing the same R_{GND} .

If the calculated power dissipation requires the use of a large resistor, or several devices have to share the same resistor, then ST suggests using solution 2 below.

3.1.2 Solution 2: a diode (D_{GND}) in the ground line

A resistor ($R_{GND} = 1 \text{ k}\Omega$) should be inserted in parallel to D_{GND} if the device will be driving an inductive load. This small signal diode can be safely shared amongst several different HSD. Also in this case, the presence of the ground network will produce a shift ($\approx 600 \text{ mV}$) in the input threshold and the status output values if the microprocessor ground is not common with the device ground. This shift will not vary if more than one HSD shares the same diode/resistor network. Series resistor in INPUT and STATUS lines are also required to prevent that, during battery voltage transient, the current exceeds the Absolute Maximum Rating. Safest configuration for unused INPUT and STATUS pin is to leave them unconnected.

3.2 Load dump protection

D_{ld} is necessary (voltage transient suppressor) if the load dump peak voltage exceeds the V_{CC} maximum DC rating. The same applies if the device is subject to transients on the V_{CC} line that are greater than those shown in the ISO T/R 7637/1 table.

3.3 MCU I/O protection

If a ground protection network is used and negative transients are present on the V_{CC} line, the control pins will be pulled negative. ST suggests to insert a resistor (R_{prot}) in line to prevent the microcontroller I/O pins from latching up.

The value of these resistors is a compromise between the leakage current of microcontroller and the current required by the HSD I/Os (Input levels compatibility) with the latch-up limit of microcontroller I/Os:

$$-V_{CCpeak} / I_{latchup} \leq R_{prot} \leq (V_{OH\mu C} - V_{IH} - V_{GND}) / I_{IHmax}$$

Example

For the following conditions:

$$V_{CCpeak} = -100 \text{ V}$$

$$I_{latchup} \geq 20 \text{ mA}$$

$$V_{OH\mu C} \geq 4.5 \text{ V}$$

$$5 \text{ k}\Omega \leq R_{prot} \leq 65 \text{ k}\Omega.$$

Recommended values are:

$$R_{prot} = 10 \text{ k}\Omega$$

3.4 Open-load detection in off-state

Off-state open-load detection requires an external pull-up resistor (R_{PU}) connected between OUTPUT pin and a positive supply voltage (V_{PU}) like the +5V line used to supply the microprocessor.

The external resistor has to be selected according to the following requirements:

1) no false open-load indication when load is connected: in this case we have to avoid V_{OUT} to be higher than V_{OLmin} ; this results in the following condition

$$V_{OUT} = (V_{PU} / (R_L + R_{PU}))R_L < V_{OLmin}.$$

2) no misdetection when load is disconnected: in this case the V_{OUT} has to be higher than V_{OLmax} ; this results in the following condition $R_{PU} < (V_{PU} - V_{OLmax}) / I_{L(off2)}$.

Because $I_{s(OFF)}$ may significantly increase if V_{out} is pulled high (up to several mA), the pull-up resistor R_{PU} should be connected to a supply that is switched OFF when the module is in standby.

Figure 25. Open-load detection in off-state

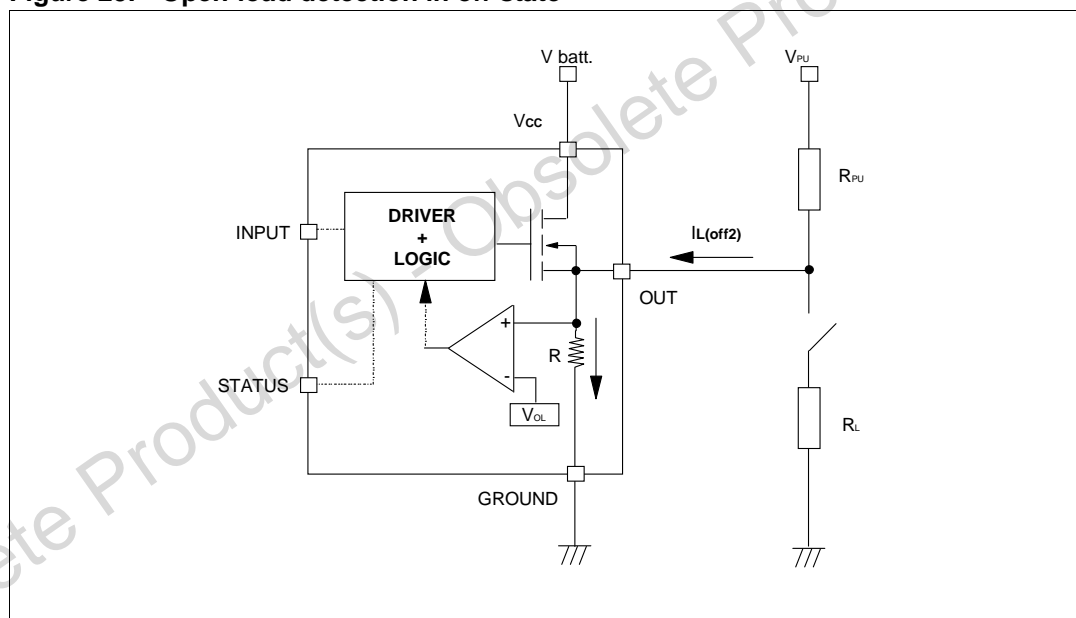

3.5 Maximum demagnetization energy ($V_{CC} = 13.5\text{ V}$)

Figure 26. Maximum turn-off current versus load inductance⁽¹⁾

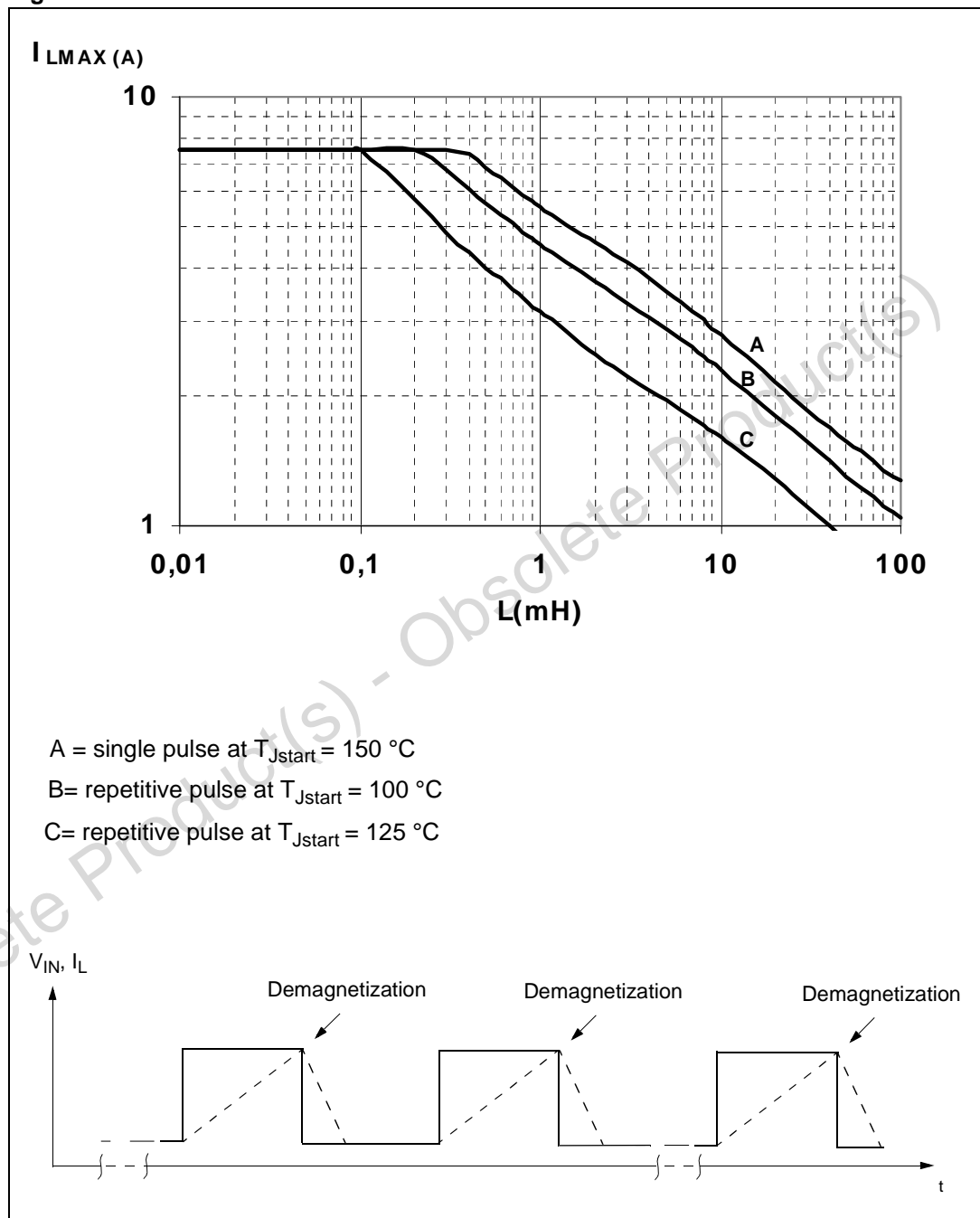

1. Values are generated with $R_L = 0\Omega$.
 In case of repetitive pulses, T_{Jstart} (at beginning of each demagnetization) of every pulse must not exceed the temperature specified above for curves B and C.

4 Package and PCB thermal data

4.1 PowerSO-10 thermal data

Figure 27. PowerSO-10 PC board⁽¹⁾

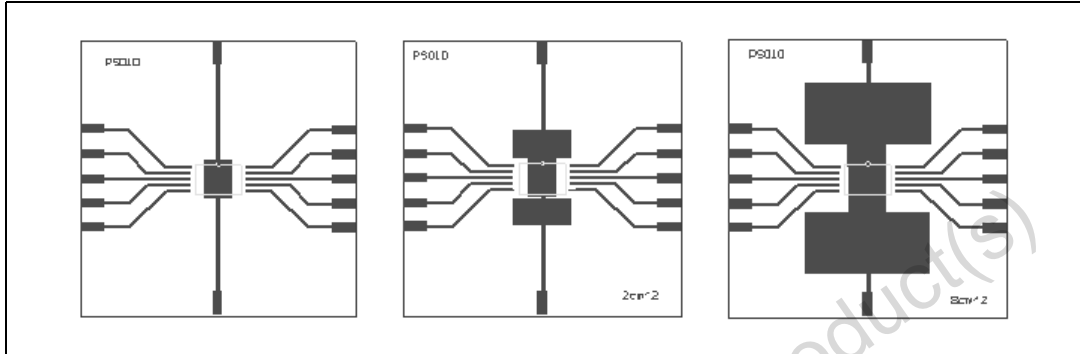

1. Layout condition of R_{th} and Z_{th} measurements (PCB FR4 area = 58 mm x 58 mm, PCB thickness = 2 mm, Cu thickness = 35 μ m, Copper areas: from minimum pad lay-out to 8 cm²).

Figure 28. $R_{thj-amb}$ vs PCB copper area in open box free air condition

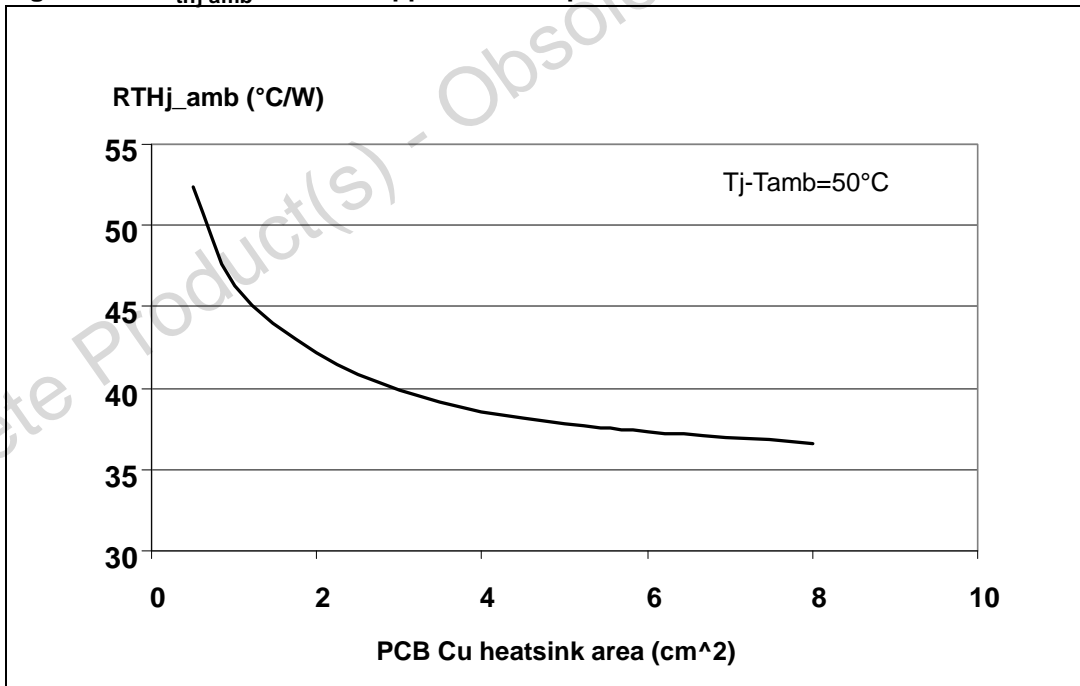
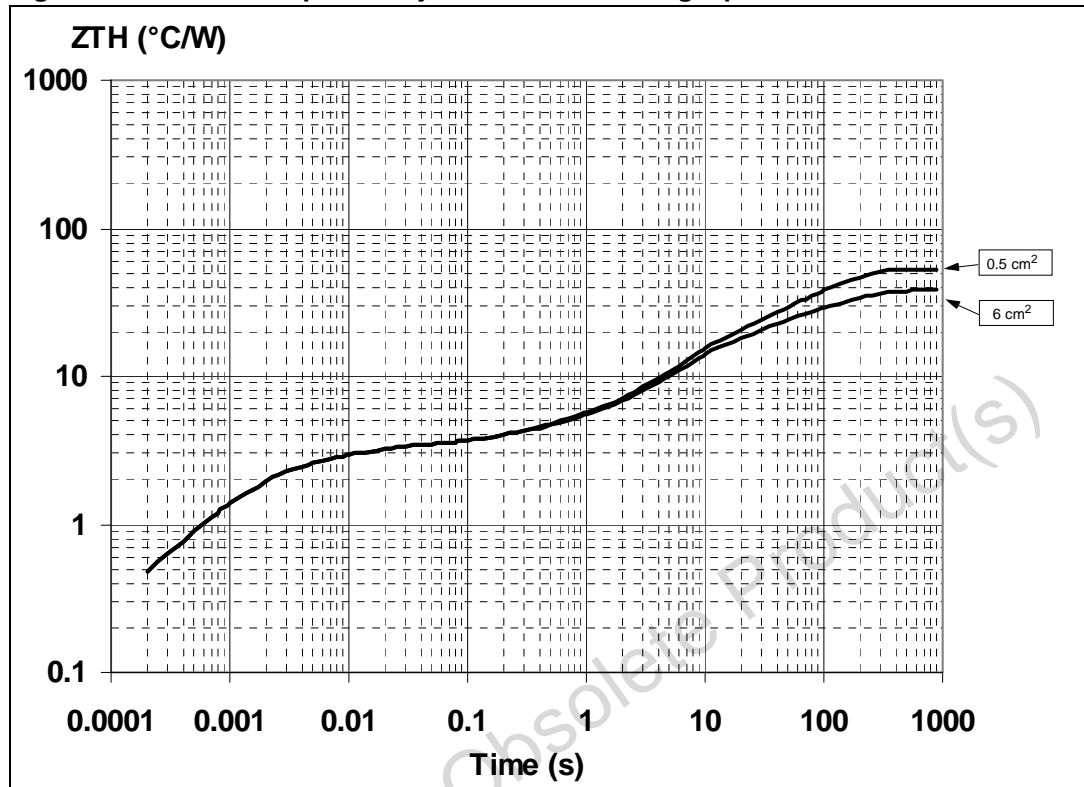

Figure 29. Thermal impedance junction ambient single pulse



Equation 1: pulse calculation formula

$$Z_{TH\delta} = R_{TH} \cdot \delta + Z_{THtp}(1 - \delta)$$

where $\delta = t_p/T$

Figure 30. Thermal fitting model of a double channel HSD in PowerSO-10

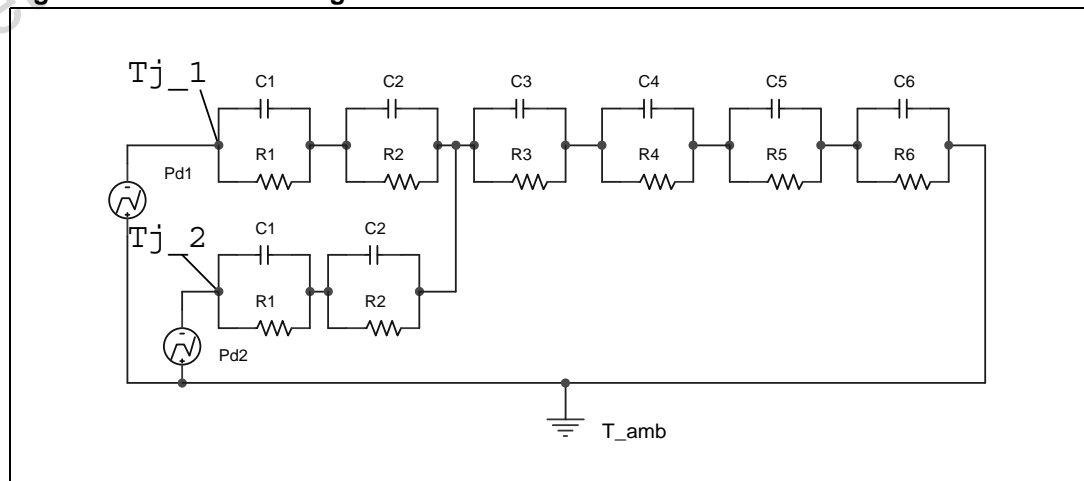

Table 14. Thermal parameters

Area / island (cm ²)	Footprint	6
R1 (°C/W)	0.35	
R2 (°C/W)	1.8	
R3 (°C/W)	1.1	
R4 (°C/W)	0.8	
R5 (°C/W)	12	
R6 (°C/W)	37	22
C1 (W.s/°C)	0.0001	
C2 (W.s/°C)	7E-04	
C3 (W.s/°C)	0.008	
C4 (W.s/°C)	0.3	
C5 (W.s/°C)	0.75	
C6 (W.s/°C)	3	5

5 Package and packing information

5.1 ECOPACK[®] packages

In order to meet environmental requirements, ST offers these devices in different grades of ECOPACK[®] packages, depending on their level of environmental compliance. ECOPACK[®] specifications, grade definitions and product status are available at: www.st.com. ECOPACK[®] is an ST trademark.

5.2 PowerSO-10 mechanical data

Figure 31. PowerSO-10 package dimensions

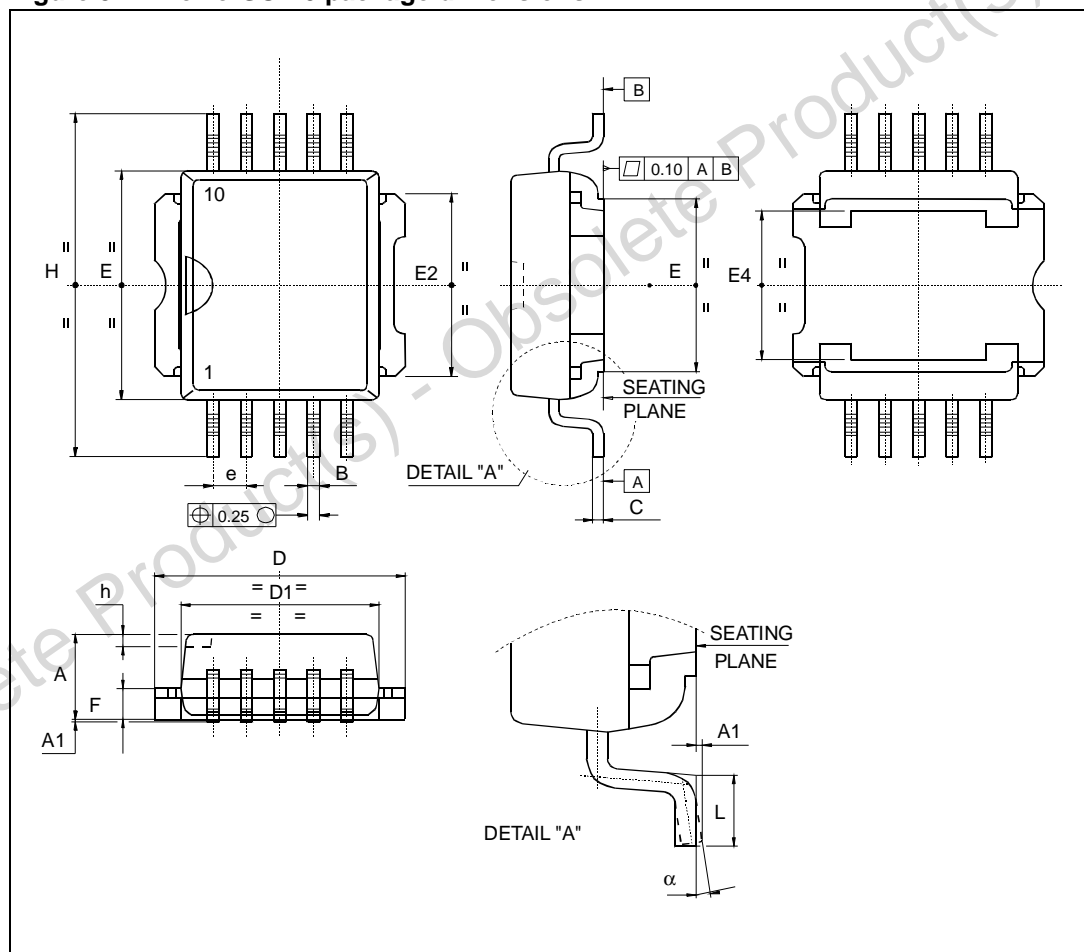

Table 15. PowerSO-10 mechanical data

Dim.	mm		
	Min.	Typ.	Max.
A	3.35		3.65
A ⁽¹⁾	3.4		3.6
A1	0		0.10
B	0.40		0.60
B ⁽¹⁾	0.37		0.53
C	0.35		0.55
C ⁽¹⁾	0.23		0.32
D	9.40		9.60
D1	7.40		7.60
E	9.30		9.50
E2	7.20		7.60
E2 ⁽¹⁾	7.30		7.50
E4	5.90		6.10
E4 ⁽¹⁾	5.90		6.30
e		1.27	
F	1.25		1.35
F ⁽¹⁾	1.20		1.40
H	13.80		14.40
H ⁽¹⁾	13.85		14.35
h		0.50	
L	1.20		1.80
L ⁽¹⁾	0.80		1.10
α	0°		8°
α ⁽¹⁾	2°		8°

1. Muar only POA P013P.

5.3 PowerSO-10 packing information

Figure 32. PowerSO-10 suggested pad layout Figure 33. PowerSO-10 tube shipment (no suffix)

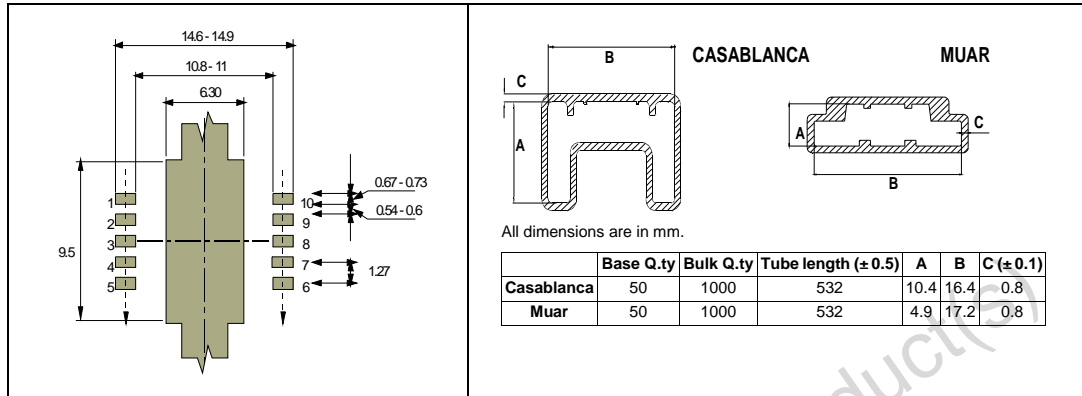
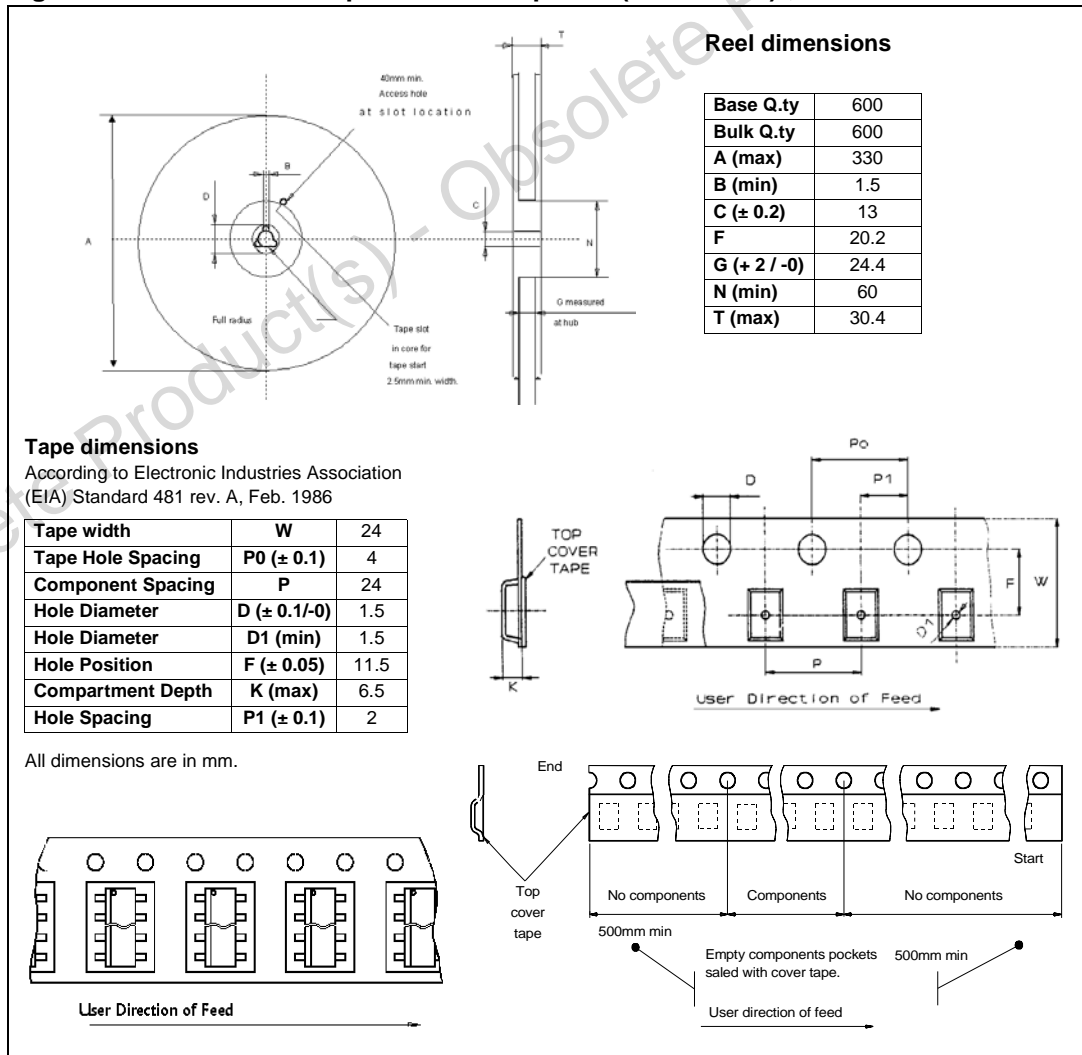

Figure 34. PowerSO-10 tape and reel shipment (suffix "TR")



6 Revision history

Table 16. Document revision history

Date	Revision	Changes
09-Sep-2004	1	Initial release.
03-May-2006	2	Current and voltage convention update (page 2). Configuration diagram (top view) & suggested connections for unused and n.c. pins insertion (page 2). 6 cm ² Cu condition insertion in thermal data table (page 3). V _{CC} - output diode section update (page 4). Protections note insertion (page 4) Revision history table insertion (page 18). Disclaimers update (page 19).
05-Dec-2008	3	Document reformatted and restructured. Added contents, list of tables and figures. Added <i>ECOPACK</i> [®] packages information.
11-Oct-2010	4	Updated <i>Features</i> list. Updated <i>Table 3: Absolute maximum ratings</i> Updated <i>Figure 5: Switching time waveforms</i>
25-Sep-2013	5	Updated disclaimer.

Please Read Carefully:

Information in this document is provided solely in connection with ST products. STMicroelectronics NV and its subsidiaries ("ST") reserve the right to make changes, corrections, modifications or improvements, to this document, and the products and services described herein at any time, without notice.

All ST products are sold pursuant to ST's terms and conditions of sale.

Purchasers are solely responsible for the choice, selection and use of the ST products and services described herein, and ST assumes no liability whatsoever relating to the choice, selection or use of the ST products and services described herein.

No license, express or implied, by estoppel or otherwise, to any intellectual property rights is granted under this document. If any part of this document refers to any third party products or services it shall not be deemed a license grant by ST for the use of such third party products or services, or any intellectual property contained therein or considered as a warranty covering the use in any manner whatsoever of such third party products or services or any intellectual property contained therein.

UNLESS OTHERWISE SET FORTH IN ST'S TERMS AND CONDITIONS OF SALE ST DISCLAIMS ANY EXPRESS OR IMPLIED WARRANTY WITH RESPECT TO THE USE AND/OR SALE OF ST PRODUCTS INCLUDING WITHOUT LIMITATION IMPLIED WARRANTIES OF MERCHANTABILITY, FITNESS FOR A PARTICULAR PURPOSE (AND THEIR EQUIVALENTS UNDER THE LAWS OF ANY JURISDICTION), OR INFRINGEMENT OF ANY PATENT, COPYRIGHT OR OTHER INTELLECTUAL PROPERTY RIGHT.

ST PRODUCTS ARE NOT DESIGNED OR AUTHORIZED FOR USE IN: (A) SAFETY CRITICAL APPLICATIONS SUCH AS LIFE SUPPORTING, ACTIVE IMPLANTED DEVICES OR SYSTEMS WITH PRODUCT FUNCTIONAL SAFETY REQUIREMENTS; (B) AERONAUTIC APPLICATIONS; (C) AUTOMOTIVE APPLICATIONS OR ENVIRONMENTS, AND/OR (D) AEROSPACE APPLICATIONS OR ENVIRONMENTS. WHERE ST PRODUCTS ARE NOT DESIGNED FOR SUCH USE, THE PURCHASER SHALL USE PRODUCTS AT PURCHASER'S SOLE RISK, EVEN IF ST HAS BEEN INFORMED IN WRITING OF SUCH USAGE, UNLESS A PRODUCT IS EXPRESSLY DESIGNATED BY ST AS BEING INTENDED FOR "AUTOMOTIVE, AUTOMOTIVE SAFETY OR MEDICAL" INDUSTRY DOMAINS ACCORDING TO ST PRODUCT DESIGN SPECIFICATIONS. PRODUCTS FORMALLY ESCC, QML OR JAN QUALIFIED ARE DEEMED SUITABLE FOR USE IN AEROSPACE BY THE CORRESPONDING GOVERNMENTAL AGENCY.

Resale of ST products with provisions different from the statements and/or technical features set forth in this document shall immediately void any warranty granted by ST for the ST product or service described herein and shall not create or extend in any manner whatsoever, any liability of ST.

ST and the ST logo are trademarks or registered trademarks of ST in various countries.

Information in this document supersedes and replaces all information previously supplied.

The ST logo is a registered trademark of STMicroelectronics. All other names are the property of their respective owners.

© 2013 STMicroelectronics - All rights reserved

STMicroelectronics group of companies

Australia - Belgium - Brazil - Canada - China - Czech Republic - Finland - France - Germany - Hong Kong - India - Israel - Italy - Japan - Malaysia - Malta - Morocco - Philippines - Singapore - Spain - Sweden - Switzerland - United Kingdom - United States of America

www.st.com

