

# Axial Lead Rectifiers

## SCHOTTKY BARRIER RECTIFIERS

1.0 AMPERE 20, 30 and 40 VOLTS

### 1N5817, 1N5818, 1N5819

This series employs the Schottky Barrier principle in a large area metal-to-silicon power diode. State-of-the-art geometry features chrome barrier metal, epitaxial construction with oxide passivation and metal overlap contact. Ideally suited for use as rectifiers in low-voltage, high-frequency inverters, free wheeling diodes, and polarity protection diodes.

#### Features

- Extremely Low  $V_F$
- Low Stored Charge, Majority Carrier Conduction
- Low Power Loss/High Efficiency
- These are Pb-Free Devices\*

#### Mechanical Characteristics:

- Case: Epoxy, Molded
- Weight: 0.4 Gram (Approximately)
- Finish: All External Surfaces Corrosion Resistant and Terminal Leads are Readily Solderable
- Lead Temperature for Soldering Purposes:  
260°C Max for 10 Seconds
- Polarity: Cathode Indicated by Polarity Band
- ESD Ratings: Machine Model = C (>400 V)  
Human Body Model = 3B (>8000 V)

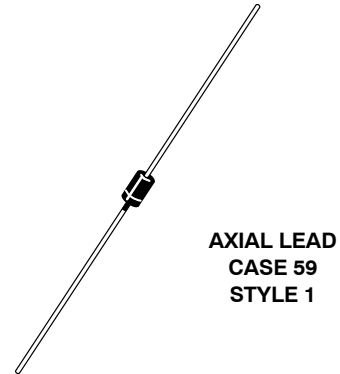

#### MARKING DIAGRAM

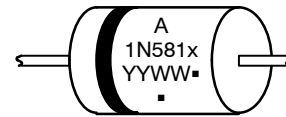

A = Assembly Location  
1N581x = Device Number  
x = 7, 8, or 9  
YY = Year  
WW = Work Week  
▪ = Pb-Free Package

(Note: Microdot may be in either location)

#### ORDERING INFORMATION

See detailed ordering and shipping information on page 6 of this data sheet.

\*For additional information on our Pb-Free strategy and soldering details, please download the onsemi Soldering and Mounting Techniques Reference Manual, SOLDERRM/D.

# 1N5817, 1N5818, 1N5819

## MAXIMUM RATINGS

Rating	Symbol	1N5817	1N5818	1N5819	Unit
Peak Repetitive Reverse Voltage Working Peak Reverse Voltage DC Blocking Voltage	$V_{RRM}$ $V_{RWM}$ $V_R$	20	30	40	V
Non-Repetitive Peak Reverse Voltage	$V_{RSM}$	24	36	48	V
RMS Reverse Voltage	$V_{R(RMS)}$	14	21	28	V
Average Rectified Forward Current (Note 1), ( $V_{R(equiv)} \leq 0.2 V_R(dc)$ , $T_L = 90^\circ C$ , $R_{\theta JA} = 80^\circ C/W$ , P.C. Board Mounting, see Note 2, $T_A = 55^\circ C$ )	$I_O$	1.0			A
Ambient Temperature (Rated $V_R(dc)$ , $P_{F(AV)} = 0$ , $R_{\theta JA} = 80^\circ C/W$ )	$T_A$	85	80	75	$^\circ C$
Non-Repetitive Peak Surge Current, (Surge applied at rated load conditions, half-wave, single phase 60 Hz, $T_L = 70^\circ C$ )	$I_{FSM}$	25 (for one cycle)			A
Operating and Storage Junction Temperature Range (Reverse Voltage applied)	$T_J, T_{stg}$	-65 to +125			$^\circ C$
Peak Operating Junction Temperature (Forward Current applied)	$T_{J(pk)}$	150			$^\circ C$

Stresses exceeding those listed in the Maximum Ratings table may damage the device. If any of these limits are exceeded, device functionality should not be assumed, damage may occur and reliability may be affected.

## THERMAL CHARACTERISTICS (Note 1)

Characteristic	Symbol	Max	Unit
Thermal Resistance, Junction-to-Ambient	$R_{\theta JA}$	80	$^\circ C/W$

## ELECTRICAL CHARACTERISTICS ( $T_L = 25^\circ C$ unless otherwise noted) (Note 1)

Characteristic	Symbol	1N5817	1N5818	1N5819	Unit
Maximum Instantaneous Forward Voltage (Note 2) ( $i_F = 0.1 A$ ) ( $i_F = 1.0 A$ ) ( $i_F = 3.0 A$ )	$V_F$	0.32 0.45 0.75	0.33 0.55 0.875	0.34 0.6 0.9	V
Maximum Instantaneous Reverse Current @ Rated dc Voltage (Note 2) ( $T_L = 25^\circ C$ ) ( $T_L = 100^\circ C$ )	$I_R$	1.0 10	1.0 10	1.0 10	mA

- Lead Temperature reference is cathode lead 1/32 in from case.
- Pulse Test: Pulse Width = 300  $\mu s$ , Duty Cycle = 2.0%.

# 1N5817, 1N5818, 1N5819

## NOTE 3. — DETERMINING MAXIMUM RATINGS

Reverse power dissipation and the possibility of thermal runaway must be considered when operating this rectifier at reverse voltages above  $0.1 V_{RWM}$ . Proper derating may be accomplished by use of equation (1).

$$T_{A(max)} = T_{J(max)} - R_{\theta JA} P_{F(AV)} - R_{\theta JA} P_{R(AV)} \quad (1)$$

where  $T_{A(max)}$  = Maximum allowable ambient temperature  
 $T_{J(max)}$  = Maximum allowable junction temperature (125°C or the temperature at which thermal runaway occurs, whichever is lowest)  
 $P_{F(AV)}$  = Average forward power dissipation  
 $P_{R(AV)}$  = Average reverse power dissipation  
 $R_{\theta JA}$  = Junction-to-ambient thermal resistance

Figures 1, 2, and 3 permit easier use of equation (1) by taking reverse power dissipation and thermal runaway into consideration. The figures solve for a reference temperature as determined by equation (2).

$$T_R = T_{J(max)} - R_{\theta JA} P_{R(AV)} \quad (2)$$

Substituting equation (2) into equation (1) yields:

$$T_{A(max)} = T_R - R_{\theta JA} P_{F(AV)} \quad (3)$$

Inspection of equations (2) and (3) reveals that  $T_R$  is the ambient temperature at which thermal runaway occurs or where  $T_J = 125^\circ\text{C}$ , when forward power is zero. The transition from one boundary condition to the other is evident on the curves of Figures 1, 2, and 3 as a difference in the rate of change of the slope in the vicinity of  $115^\circ\text{C}$ . The data of Figures 1, 2, and 3 is based upon dc conditions. For use in common rectifier circuits, Table 1 indicates suggested factors for an equivalent dc voltage to use for conservative design, that is:

$$V_{R(equiv)} = V_{in(PK)} \times F \quad (4)$$

The factor F is derived by considering the properties of the various rectifier circuits and the reverse characteristics of Schottky diodes.

EXAMPLE: Find  $T_{A(max)}$  for 1N5818 operated in a 12-volt dc supply using a bridge circuit with capacitive filter such that  $I_{DC} = 0.4 \text{ A}$  ( $I_{F(AV)} = 0.5 \text{ A}$ ),  $I_{(FM)}/I_{(AV)} = 10$ , Input Voltage =  $10 V_{(rms)}$ ,  $R_{\theta JA} = 80^\circ\text{C/W}$ .

Step 1. Find  $V_{R(equiv)}$ . Read  $F = 0.65$  from Table 1,  
 $\therefore V_{R(equiv)} = (1.41)(10)(0.65) = 9.2 \text{ V}$ .

Step 2. Find  $T_R$  from Figure 2. Read  $T_R = 109^\circ\text{C}$   
 @  $V_R = 9.2 \text{ V}$  and  $R_{\theta JA} = 80^\circ\text{C/W}$ .

Step 3. Find  $P_{F(AV)}$  from Figure 4. \*\*Read  $P_{F(AV)} = 0.5 \text{ W}$   
 @  $\frac{I_{(FM)}}{I_{(AV)}} = 10$  and  $I_{F(AV)} = 0.5 \text{ A}$ .

Step 4. Find  $T_{A(max)}$  from equation (3).  
 $T_{A(max)} = 109 - (80)(0.5) = 69^\circ\text{C}$ .

\*\*Values given are for the 1N5818. Power is slightly lower for the 1N5817 because of its lower forward voltage, and higher for the 1N5819.

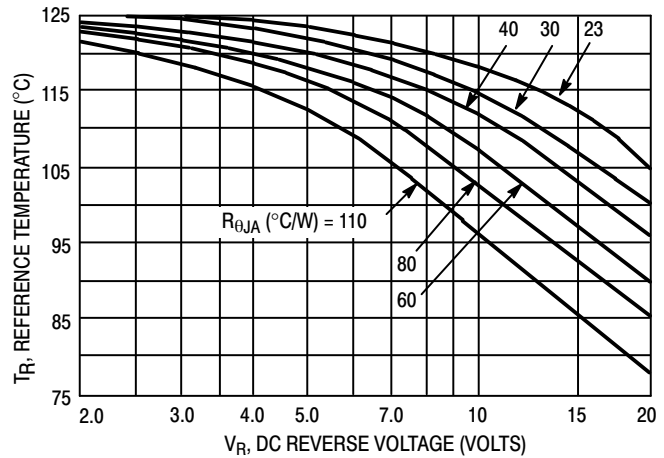

Figure 1. Maximum Reference Temperature 1N5817

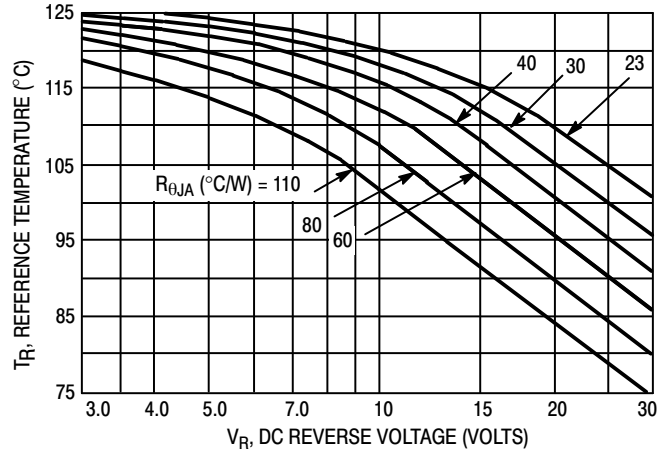

Figure 2. Maximum Reference Temperature 1N5818

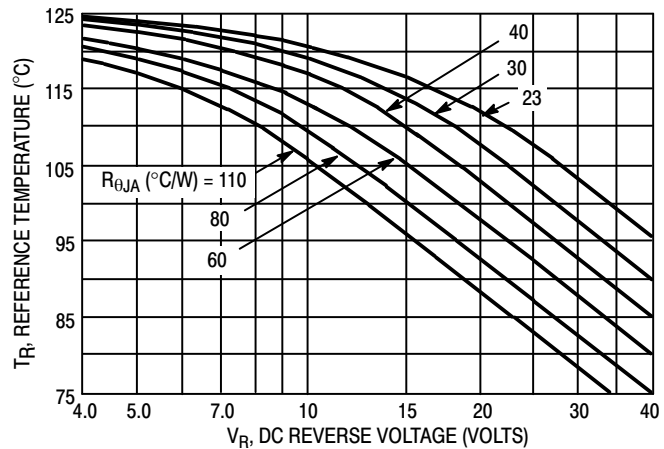

Figure 3. Maximum Reference Temperature 1N5819

Table 1. Values for Factor F

Circuit	Half Wave		Full Wave, Bridge		Full Wave, Center Tapped* †	
	Resistive	Capacitive*	Resistive	Capacitive	Resistive	Capacitive
Sine Wave	0.5	1.3	0.5	0.65	1.0	1.3
Square Wave	0.75	1.5	0.75	0.75	1.5	1.5

\*\*Note that  $V_{R(PK)} \approx 2.0 V_{in(PK)}$ .

†Use line to center tap voltage for  $V_{in}$ .

# 1N5817, 1N5818, 1N5819

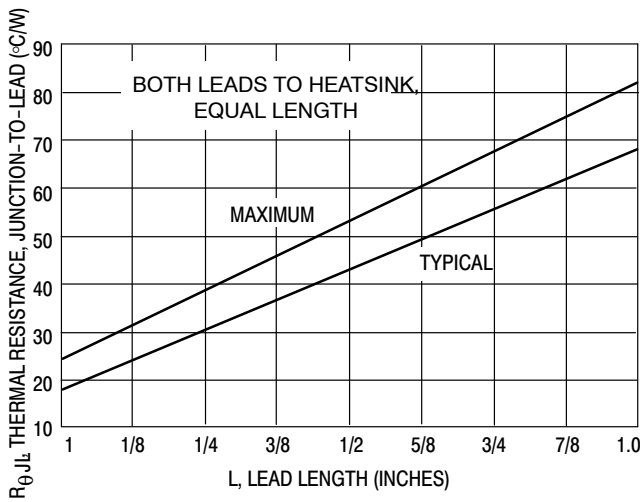

Figure 4. Steady-State Thermal Resistance

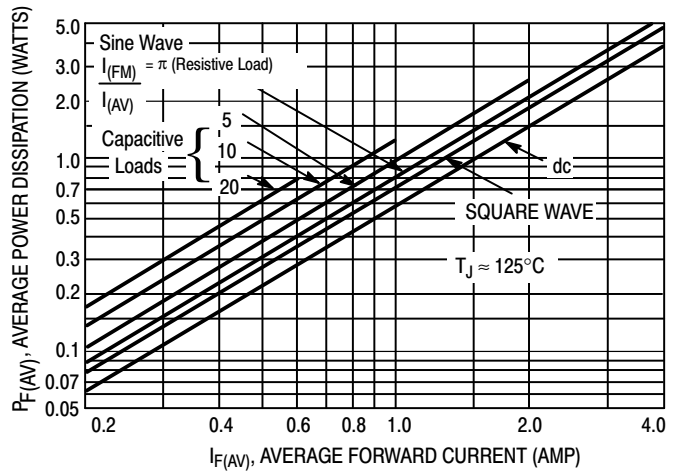

Figure 5. Forward Power Dissipation  
1N5817-19

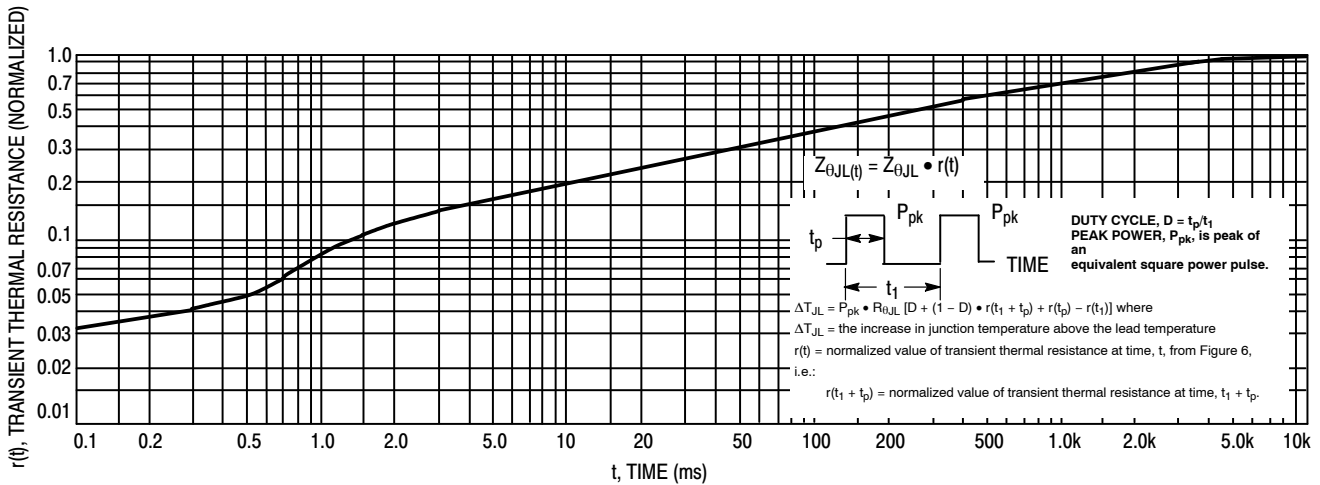

Figure 6. Thermal Response

### NOTE 4. — MOUNTING DATA

Data shown for thermal resistance, junction-to-ambient ( $R_{\theta JA}$ ) for the mountings shown is to be used as typical guideline values for preliminary engineering, or in case the tie point temperature cannot be measured.

### TYPICAL VALUES FOR $R_{\theta JA}$ IN STILL AIR

Mounting Method	Lead Length, L (in)				$R_{\theta JA}$
	1/8	1/4	1/2	3/4	
1	52	65	72	85	$^{\circ}\text{C/W}$
2	67	80	87	100	$^{\circ}\text{C/W}$
3	50				$^{\circ}\text{C/W}$

#### Mounting Method 1

P.C. Board with 1-1/2" x 1-1/2" copper surface.

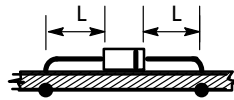

#### Mounting Method 3

P.C. Board with 1-1/2" x 1-1/2" copper surface.

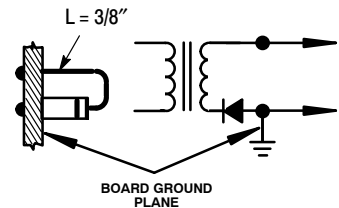

#### Mounting Method 2

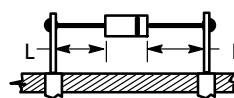

VECTOR PIN MOUNTING

# 1N5817, 1N5818, 1N5819

## NOTE 5. — THERMAL CIRCUIT MODEL (For heat conduction through the leads)

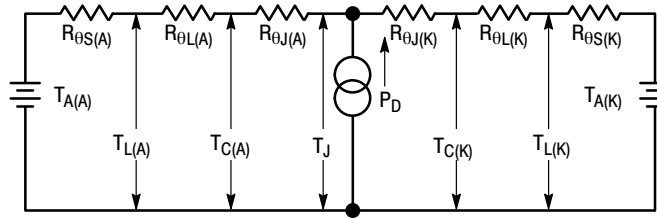

Use of the above model permits junction to lead thermal resistance for any mounting configuration to be found. For a given total lead length, lowest values occur when one side of the rectifier is brought as close as possible to the heatsink. Terms in the model signify:

- $T_A$  = Ambient Temperature       $T_C$  = Case Temperature
- $T_L$  = Lead Temperature           $T_J$  = Junction Temperature
- $R_{\theta S}$  = Thermal Resistance, Heatsink to Ambient
- $R_{\theta L}$  = Thermal Resistance, Lead to Heatsink
- $R_{\theta J}$  = Thermal Resistance, Junction to Case
- $P_D$  = Power Dissipation

(Subscripts A and K refer to anode and cathode sides, respectively.) Values for thermal resistance components are:

- $R_{\theta L}$  = 100°C/W/in typically and 120°C/W/in maximum
- $R_{\theta J}$  = 36°C/W typically and 46°C/W maximum.

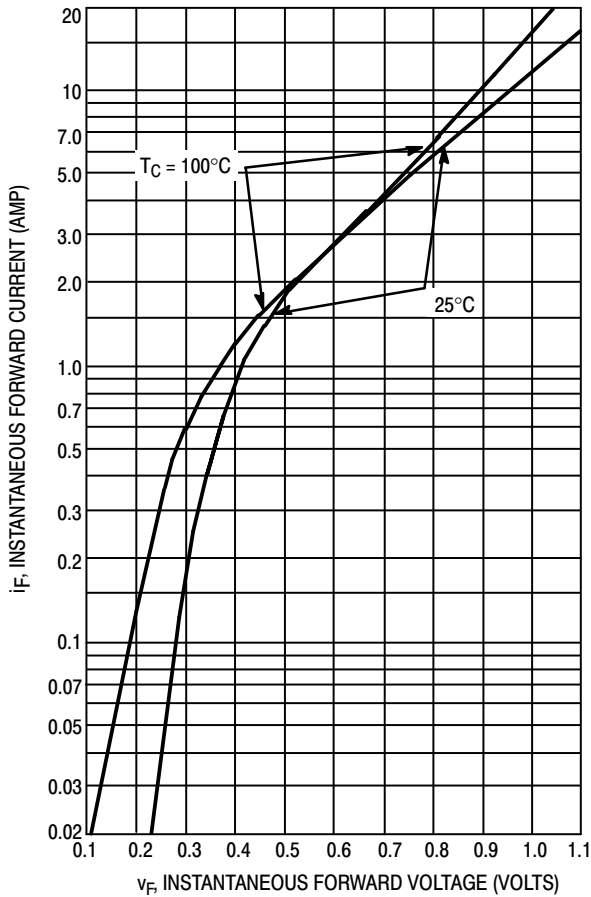

Figure 7. Typical Forward Voltage

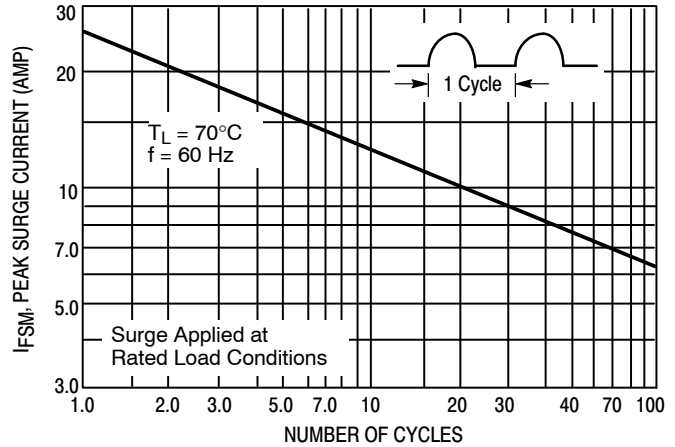

Figure 8. Maximum Non-Repetitive Surge Current

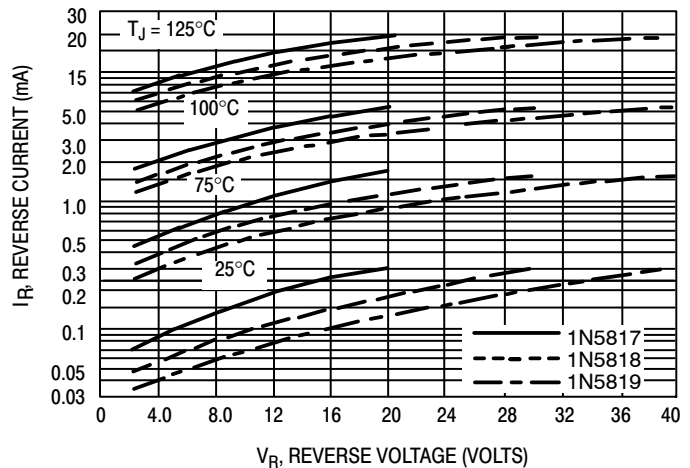

Figure 9. Typical Reverse Current

# 1N5817, 1N5818, 1N5819

## NOTE 6. — HIGH FREQUENCY OPERATION

Since current flow in a Schottky rectifier is the result of majority carrier conduction, it is not subject to junction diode forward and reverse recovery transients due to minority carrier injection and stored charge. Satisfactory circuit analysis work may be performed by using a model consisting of an ideal diode in parallel with a variable capacitance. (See Figure 10.)

Rectification efficiency measurements show that operation will be satisfactory up to several megahertz. For example, relative waveform rectification efficiency is approximately 70 percent at 2.0 MHz, e.g., the ratio of dc power to RMS power in the load is 0.28 at this frequency, whereas perfect rectification would yield 0.406 for sine wave inputs. However, in contrast to ordinary junction diodes, the loss in waveform efficiency is not indicative of power loss: it is simply a result of reverse current flow through the diode capacitance, which lowers the dc output voltage.

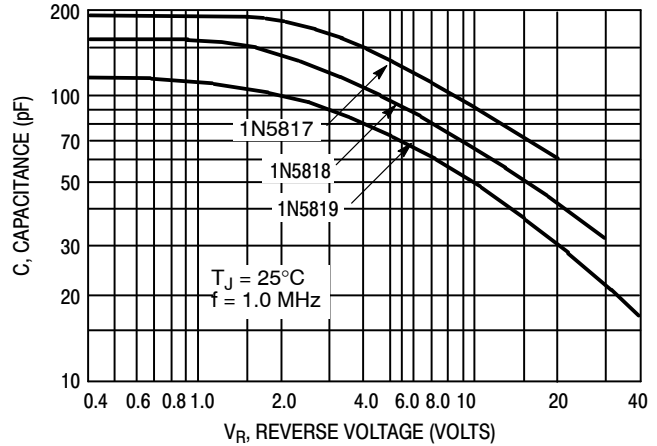

Figure 10. Typical Capacitance

## ORDERING INFORMATION

Device	Package	Shipping <sup>†</sup>
1N5817	Axial Lead*	1000 Units / Bag
1N5817G	Axial Lead*	1000 Units / Bag
1N5817RL	Axial Lead*	5000 / Tape & Reel
1N5817RLG	Axial Lead*	5000 / Tape & Reel
1N5818	Axial Lead*	1000 Units / Bag
1N5818G	Axial Lead*	1000 Units / Bag
1N5818RL	Axial Lead*	5000 / Tape & Reel
1N5818RLG	Axial Lead*	5000 / Tape & Reel
1N5819	Axial Lead*	1000 Units / Bag
1N5819G	Axial Lead*	1000 Units / Bag
1N5819RL	Axial Lead*	5000 / Tape & Reel
1N5819RLG	Axial Lead*	5000 / Tape & Reel

<sup>†</sup>For information on tape and reel specifications, including part orientation and tape sizes, please refer to our Tape and Reel Packaging Specifications Brochure, BRD8011/D.

\*This package is inherently Pb-Free.

# MECHANICAL CASE OUTLINE

## PACKAGE DIMENSIONS

ON Semiconductor®



### AXIAL LEAD CASE 59-10 ISSUE U

DATE 15 FEB 2005



SCALE 1:1

POLARITY INDICATOR  
OPTIONAL AS NEEDED  
(SEE STYLES)

STYLE 1:  
PIN 1. CATHODE (POLARITY BAND)  
2. ANODE

STYLE 2:  
NO POLARITY

NOTES:

1. DIMENSIONING AND TOLERANCING PER ANSI Y14.5M, 1982.
2. CONTROLLING DIMENSION: INCH.
3. ALL RULES AND NOTES ASSOCIATED WITH JEDEC DO-41 OUTLINE SHALL APPLY
4. POLARITY DENOTED BY CATHODE BAND.
5. LEAD DIAMETER NOT CONTROLLED WITHIN F DIMENSION.

DIM	INCHES		MILLIMETERS	
	MIN	MAX	MIN	MAX
A	0.161	0.205	4.10	5.20
B	0.079	0.106	2.00	2.70
D	0.028	0.034	0.71	0.86
F	---	0.050	---	1.27
K	1.000	---	25.40	---

### GENERIC MARKING DIAGRAM\*



- xxx = Specific Device Code
- A = Assembly Location
- YY = Year
- WW = Work Week

\*This information is generic. Please refer to device data sheet for actual part marking. Pb-Free indicator, "G" or microdot "▪", may or may not be present.

<b>DOCUMENT NUMBER:</b>	<b>98ASB42045B</b>	Electronic versions are uncontrolled except when accessed directly from the Document Repository. Printed versions are uncontrolled except when stamped "CONTROLLED COPY" in red.
<b>DESCRIPTION:</b>	<b>AXIAL LEAD</b>	<b>PAGE 1 OF 1</b>

ON Semiconductor and are trademarks of Semiconductor Components Industries, LLC dba ON Semiconductor or its subsidiaries in the United States and/or other countries. ON Semiconductor reserves the right to make changes without further notice to any products herein. ON Semiconductor makes no warranty, representation or guarantee regarding the suitability of its products for any particular purpose, nor does ON Semiconductor assume any liability arising out of the application or use of any product or circuit, and specifically disclaims any and all liability, including without limitation special, consequential or incidental damages. ON Semiconductor does not convey any license under its patent rights nor the rights of others.

**onsemi**, **Onsemi**, and other names, marks, and brands are registered and/or common law trademarks of Semiconductor Components Industries, LLC dba "**onsemi**" or its affiliates and/or subsidiaries in the United States and/or other countries. **onsemi** owns the rights to a number of patents, trademarks, copyrights, trade secrets, and other intellectual property. A listing of **onsemi**'s product/patent coverage may be accessed at [www.onsemi.com/site/pdf/Patent-Marking.pdf](http://www.onsemi.com/site/pdf/Patent-Marking.pdf). **onsemi** reserves the right to make changes at any time to any products or information herein, without notice. The information herein is provided "as-is" and **onsemi** makes no warranty, representation or guarantee regarding the accuracy of the information, product features, availability, functionality, or suitability of its products for any particular purpose, nor does **onsemi** assume any liability arising out of the application or use of any product or circuit, and specifically disclaims any and all liability, including without limitation special, consequential or incidental damages. Buyer is responsible for its products and applications using **onsemi** products, including compliance with all laws, regulations and safety requirements or standards, regardless of any support or applications information provided by **onsemi**. "Typical" parameters which may be provided in **onsemi** data sheets and/or specifications can and do vary in different applications and actual performance may vary over time. All operating parameters, including "Typicals" must be validated for each customer application by customer's technical experts. **onsemi** does not convey any license under any of its intellectual property rights nor the rights of others. **onsemi** products are not designed, intended, or authorized for use as a critical component in life support systems or any FDA Class 3 medical devices or medical devices with a same or similar classification in a foreign jurisdiction or any devices intended for implantation in the human body. Should Buyer purchase or use **onsemi** products for any such unintended or unauthorized application, Buyer shall indemnify and hold **onsemi** and its officers, employees, subsidiaries, affiliates, and distributors harmless against all claims, costs, damages, and expenses, and reasonable attorney fees arising out of, directly or indirectly, any claim of personal injury or death associated with such unintended or unauthorized use, even if such claim alleges that **onsemi** was negligent regarding the design or manufacture of the part. **onsemi** is an Equal Opportunity/Affirmative Action Employer. This literature is subject to all applicable copyright laws and is not for resale in any manner.

## PUBLICATION ORDERING INFORMATION

### LITERATURE FULFILLMENT:

Email Requests to: [orderlit@onsemi.com](mailto:orderlit@onsemi.com)

**onsemi Website:** [www.onsemi.com](http://www.onsemi.com)

### TECHNICAL SUPPORT

**North American Technical Support:**

Voice Mail: 1 800-282-9855 Toll Free USA/Canada

Phone: 011 421 33 790 2910

**Europe, Middle East and Africa Technical Support:**

Phone: 00421 33 790 2910

For additional information, please contact your local Sales Representative

