



# 2SJ661

## P-Channel Power MOSFET -60V, -38A, 39mΩ, TO-262-3L/TO-263-2L

ON Semiconductor®

<http://onsemi.com>

### Features

- ON-resistance  $R_{DS(on)1}=29.5m\Omega$ (typ.)
- Input capacitance  $C_{iss}=4360pF$  (typ.)
- 4V drive

### Specifications

Absolute Maximum Ratings at  $T_a=25^\circ C$

Parameter	Symbol	Conditions	Ratings	Unit
Drain-to-Source Voltage	$V_{DSS}$		-60	V
Gate-to-Source Voltage	$V_{GSS}$		$\pm 20$	V
Drain Current (DC)	$I_D$		-38	A
Drain Current (Pulse)	$I_{DP}$	$PW \leq 10\mu s$ , duty cycle $\leq 1\%$	-152	A
Allowable Power Dissipation	$P_D$		1.65	W
		$T_c=25^\circ C$	65	W

Continued on next page.

Package Dimensions unit : mm (typ)  
7537-001

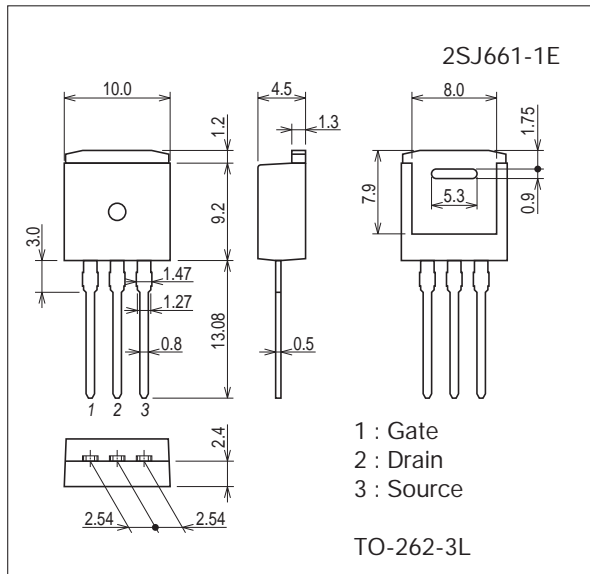

Package Dimensions unit : mm (typ)  
7535-001

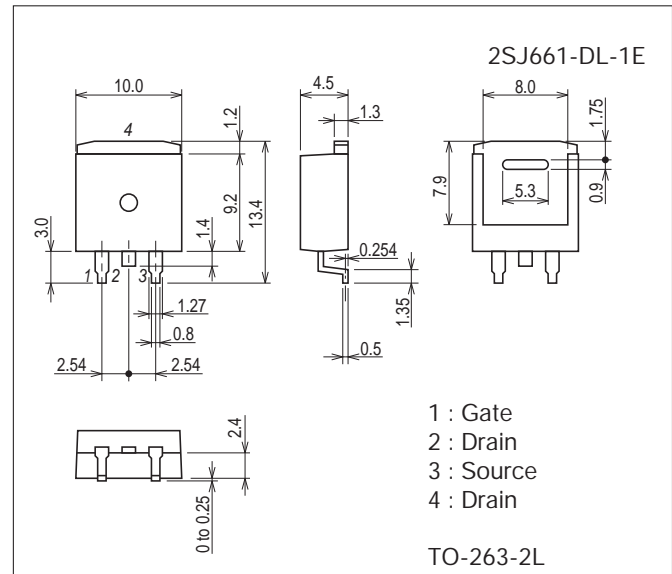

### Product & Package Information

- Package : TO-262-3L
- JEITA, JEDEC : TO-262
- Minimum Packing Quantity : 50pcs./magazine

- Package : TO-263-2L
- JEITA, JEDEC : SC-83, TO-263
- Minimum Packing Quantity : 800pcs./reel

### Marking

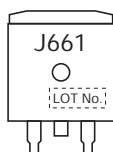

### Packing Type : DL

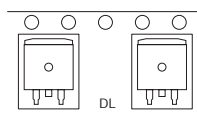

### Electrical Connection

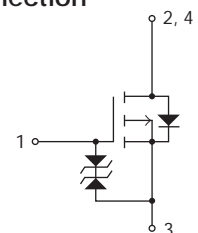

# 2SJ661

Continued from preceding page.

Parameter	Symbol	Conditions	Ratings	Unit
Channel Temperature	Tch		150	°C
Storage Temperature	Tstg		-55 to +150	°C
Avalanche Energy (Single Pulse) *1	EAS		250	mJ
Avalanche Current *2	I <sub>AV</sub>		-38	A

Note : \*1 V<sub>DD</sub>=-30V, L=200μH, I<sub>AV</sub>=-38A (Fig.1)

\*2 L≤200μH, single pulse

Stresses exceeding Maximum Ratings may damage the device. Maximum Ratings are stress ratings only. Functional operation above the Recommended Operating Conditions is not implied. Extended exposure to stresses above the Recommended Operating Conditions may affect device reliability.

## Electrical Characteristics at Ta=25°C

Parameter	Symbol	Conditions	Ratings			Unit
			min	typ	max	
Drain-to-Source Breakdown Voltage	V(BR)DSS	I <sub>D</sub> =-1mA, V <sub>GS</sub> =0V	-60			V
Zero-Gate Voltage Drain Current	I <sub>DSS</sub>	V <sub>DS</sub> =-60V, V <sub>GS</sub> =0V			-1	μA
Gate-to-Source Leakage Current	I <sub>GSS</sub>	V <sub>GS</sub> =±16V, V <sub>DS</sub> =0V			±10	μA
Cutoff Voltage	V <sub>GS(off)</sub>	V <sub>DS</sub> =-10V, I <sub>D</sub> =-1mA	-1.2		-2.6	V
Forward Transfer Admittance	y <sub>fs</sub>	V <sub>DS</sub> =-10V, I <sub>D</sub> =-19A	18	31		S
Static Drain-to-Source On-State Resistance	R <sub>DS(on)1</sub>	I <sub>D</sub> =-19A, V <sub>GS</sub> =-10V		29.5	39	mΩ
	R <sub>DS(on)2</sub>	I <sub>D</sub> =-19A, V <sub>GS</sub> =-4V		40	56	mΩ
Input Capacitance	C <sub>iss</sub>	V <sub>DS</sub> =-20V, f=1MHz		4360		pF
Output Capacitance	C <sub>oss</sub>			470		pF
Reverse Transfer Capacitance	C <sub>rss</sub>			335		pF
Turn-ON Delay Time	t <sub>d(on)</sub>			33		ns
Rise Time	t <sub>r</sub>	See Fig.2		285		ns
Turn-OFF Delay Time	t <sub>d(off)</sub>			295		ns
Fall Time	t <sub>f</sub>			195		ns
Total Gate Charge	Q <sub>g</sub>	V <sub>DS</sub> =-30V, V <sub>GS</sub> =-10V, I <sub>D</sub> =-38A		80		nC
Gate-to-Source Charge	Q <sub>gs</sub>			15		nC
Gate-to-Drain "Miller" Charge	Q <sub>gd</sub>			12		nC
Diode Forward Voltage	V <sub>SD</sub>		I <sub>S</sub> =-38A, V <sub>GS</sub> =0V	-1.0	-1.2	

Fig.1 Avalanche Resistance Test Circuit

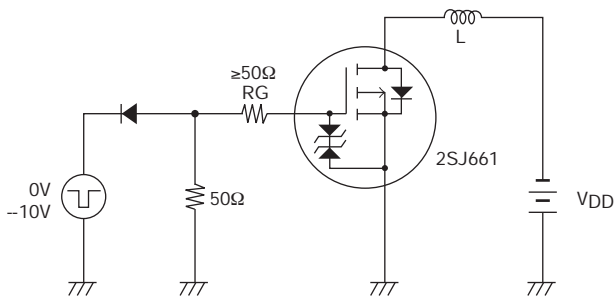
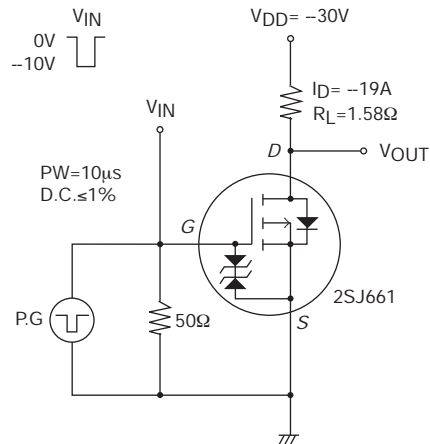
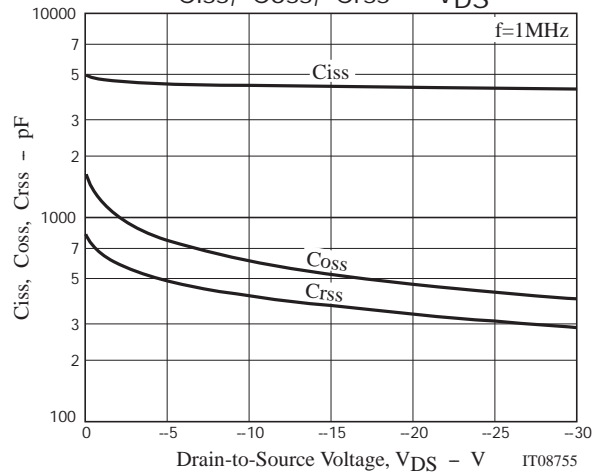
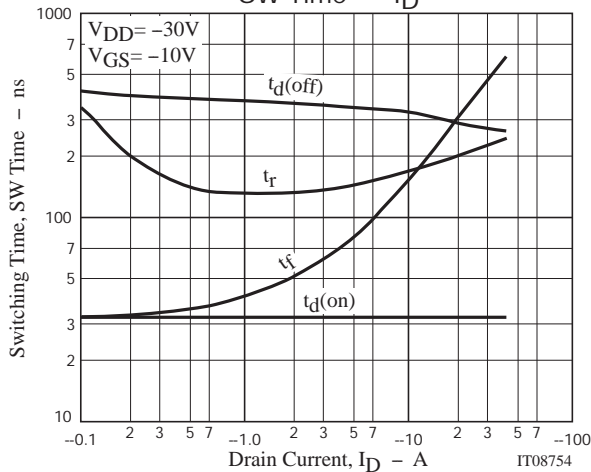
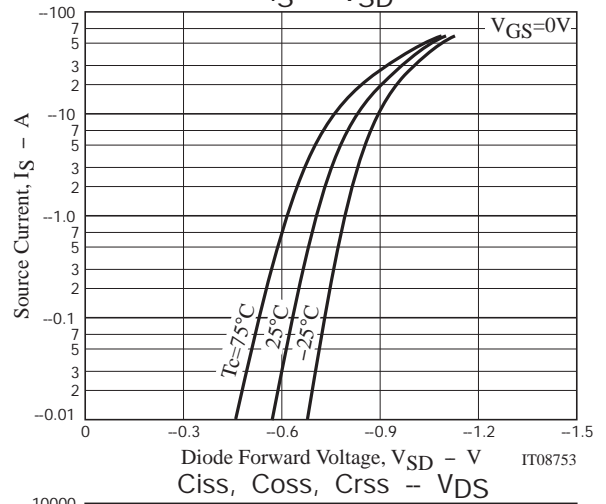
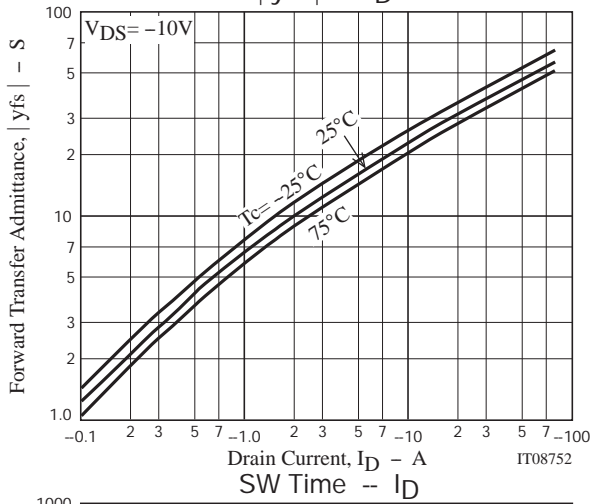
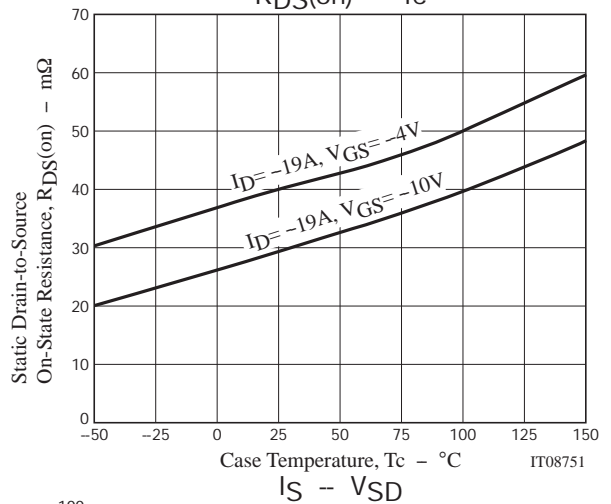
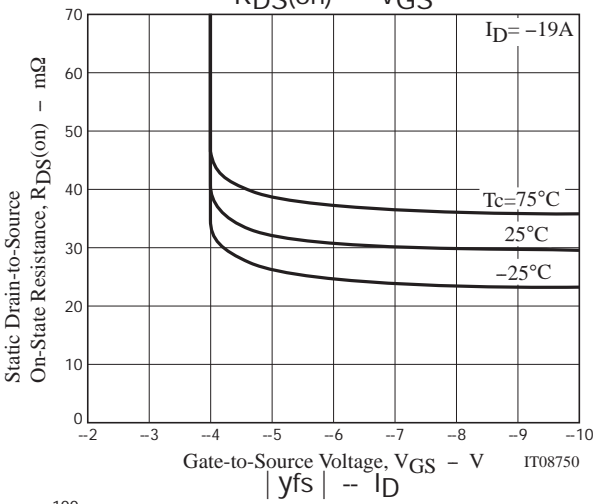
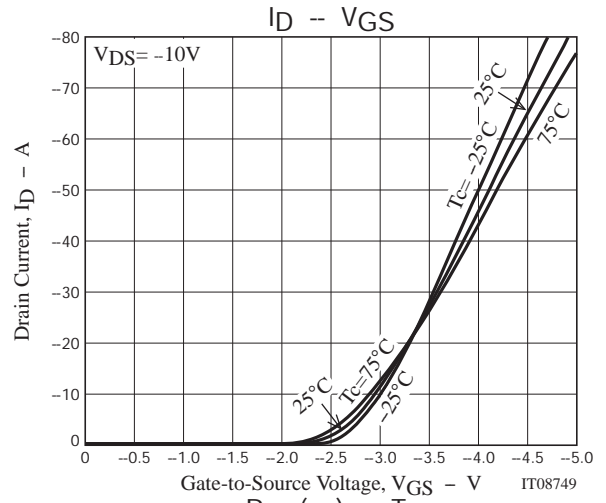
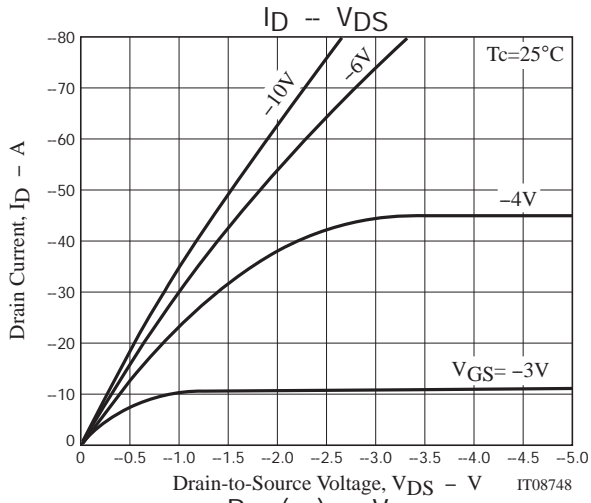

Fig.2 Switching Time Test Circuit



## Ordering Information

Device	Package	Shipping	memo
2SJ661-1E	TO-262-3L	50pcs./magazine	Pb Free
2SJ661-DL-1E	TO-263-2L	800pcs./reel	



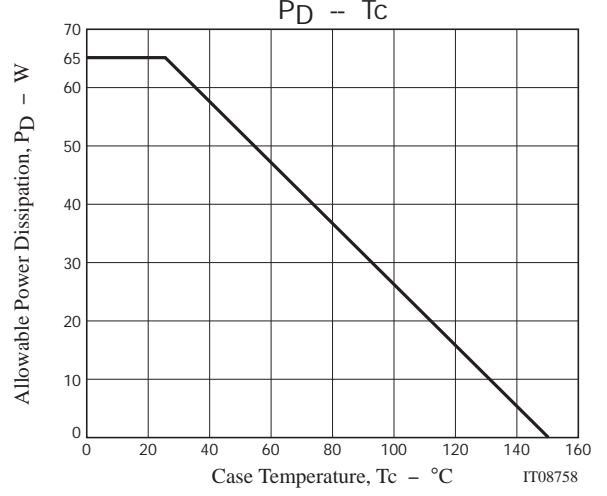
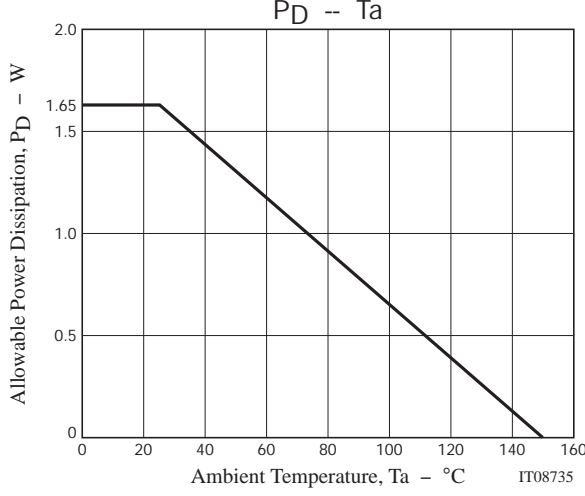
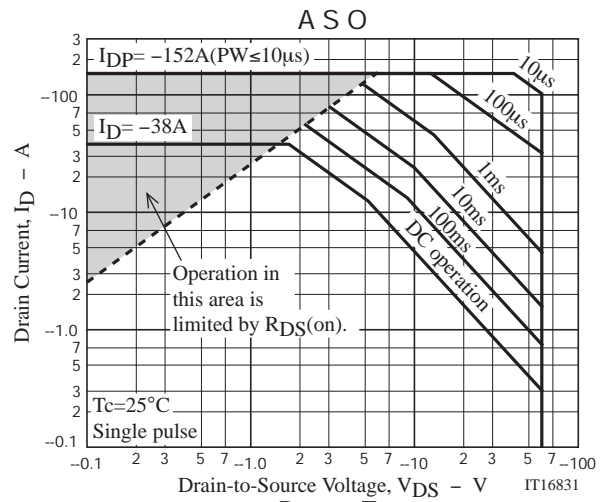
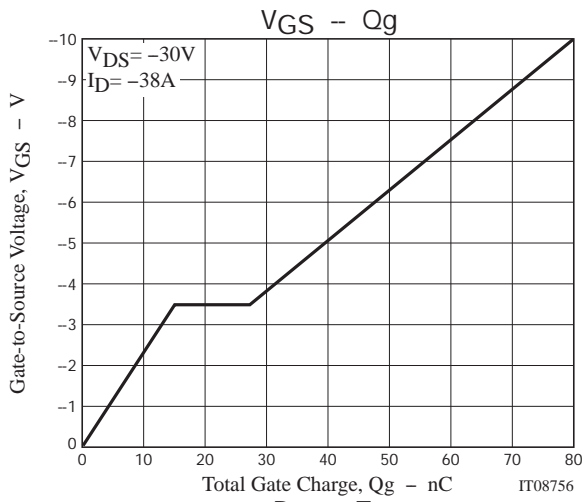





Magazine Specification

2SJ661-1E

1. Packing Format

Package Name	Maximum Number of devices contained (pcs)			Packing format	
	Magazine	Inner box	Outer box	Inner BOX	Outer BOX
TO-262-3L	50	1,000	4000	SPD-0V0001 20 magazines contained Dimensions:mm (external) 568×150×55	SPD-LV0010 4 inner boxes contained Dimensions:mm (external) 590×225×178

2. Magazine dimensions

(unit:mm)

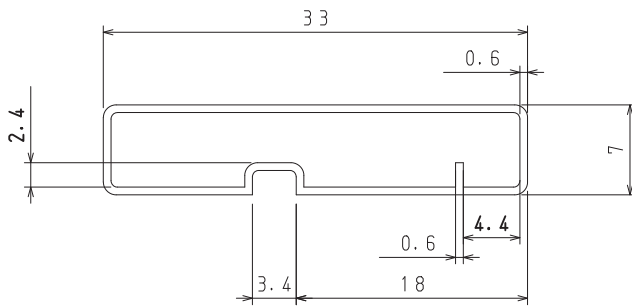

Tolerance=±0.2mm  
 Thickness=0.6+0.2/-0mm  
 Length =512.6±1mm  
 Material =PVC (Antistatic treatment)

3. Storage method to magazine

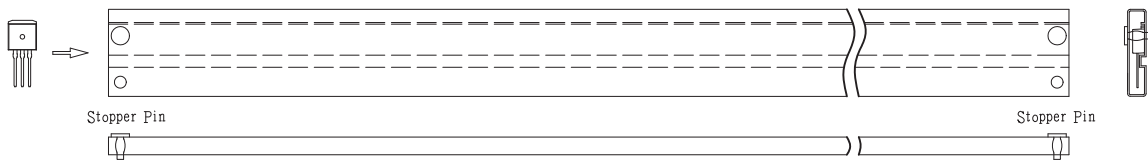

4. Inner box label (unit:mm)

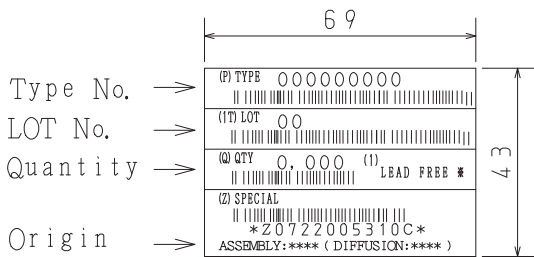

5. Outer box label (unit:mm)

It is a label at the time of factory shipments.  
 The form of a label may change in physical distribution process.

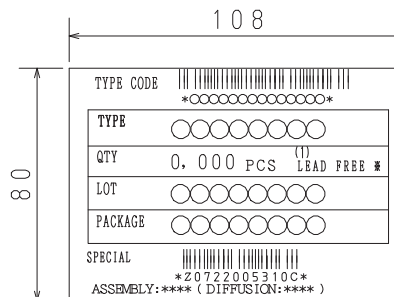

NOTE (1)

The LEAD FREE \* description shows that the surface treatment of the terminal is lead free.

Label	JEITA Phase
LEAD FREE 3	JEITA Phase 3A

Outline Drawing

2SJ661-1E

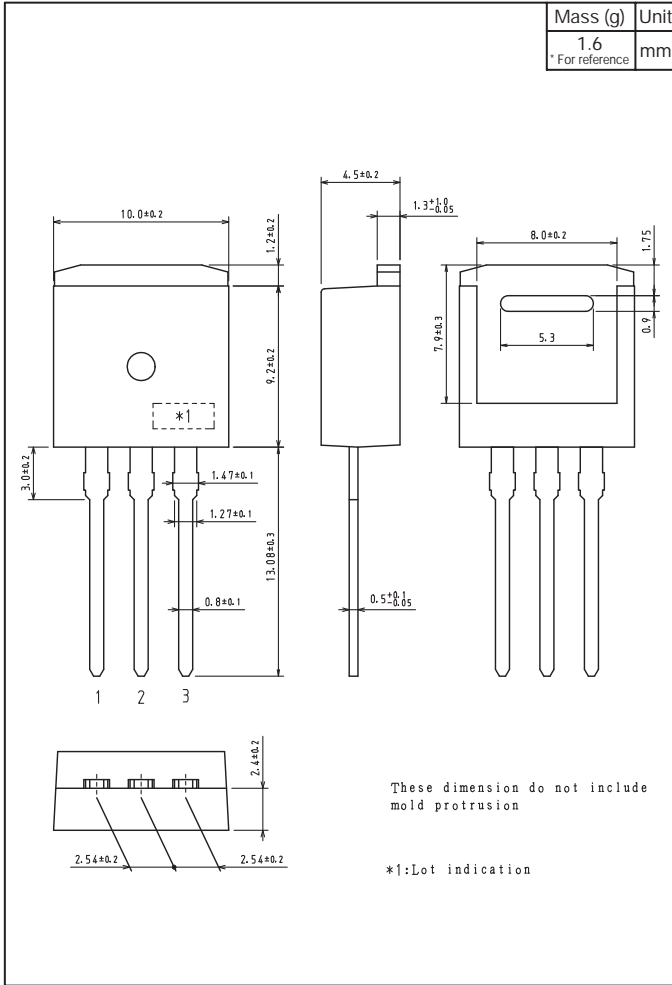



Note on usage : Since the 2SJ661 is a MOSFET product, please avoid using this device in the vicinity of highly charged objects.

ON Semiconductor and the ON logo are registered trademarks of Semiconductor Components Industries, LLC (SCILLC). SCILLC owns the rights to a number of patents, trademarks, copyrights, trade secrets, and other intellectual property. A listing of SCILLC's product/patent coverage may be accessed at [www.onsemi.com/site/pdf/Patent-Marking.pdf](http://www.onsemi.com/site/pdf/Patent-Marking.pdf). SCILLC reserves the right to make changes without further notice to any products herein. SCILLC makes no warranty, representation or guarantee regarding the suitability of its products for any particular purpose, nor does SCILLC assume any liability arising out of the application or use of any product or circuit, and specifically disclaims any and all liability, including without limitation special, consequential or incidental damages. "Typical" parameters which may be provided in SCILLC data sheets and/or specifications can and do vary in different applications and actual performance may vary over time. All operating parameters, including "Typicals" must be validated for each customer application by customer's technical experts. SCILLC does not convey any license under its patent rights nor the rights of others. SCILLC products are not designed, intended, or authorized for use as components in systems intended for surgical implant into the body, or other applications intended to support or sustain life, or for any other application in which the failure of the SCILLC product could create a situation where personal injury or death may occur. Should Buyer purchase or use SCILLC products for any such unintended or unauthorized application, Buyer shall indemnify and hold SCILLC and its officers, employees, subsidiaries, affiliates, and distributors harmless against all claims, costs, damages, and expenses, and reasonable attorney fees arising out of, directly or indirectly, any claim of personal injury or death associated with such unintended or unauthorized use, even if such claim alleges that SCILLC was negligent regarding the design or manufacture of the part. SCILLC is an Equal Opportunity/Affirmative Action Employer. This literature is subject to all applicable copyright laws and is not for resale in any manner.