

Precision micropower shunt voltage reference

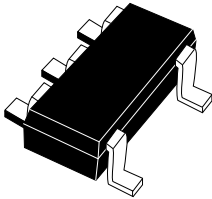

SOT323-5L

Features

- Fixed 2.048 V output voltage
- Ultra low operating current: 10 μ A at 25 °C
- High initial accuracy: \pm 0.2%
- Stable when used with capacitive loads
- Industrial (-40 to +85 °C) temperature range
- 20 ppm / °C typ., 70 ppm / °C max. temperature coefficient
- Available in SOT323-5L package

Applications

- Portable, battery-operated equipment
- Data acquisition systems
- Instrumentation

Description

The **TS4061V** is a low power high accuracy shunt voltage reference providing a stable output voltage over the industrial temperature range, with a maximum temperature coefficient of 70 ppm/°C.

The SOT323-5L package is ideal in applications where space saving is a critical issue.

The very low operating current is a key advantage for power budgeted designs. In addition, the **TS4061V** is very stable and can be used in a broad range of application conditions.

Maturity status link

[TS4061V](#)

1 Pin configuration

Figure 1. Pin connections (top view)

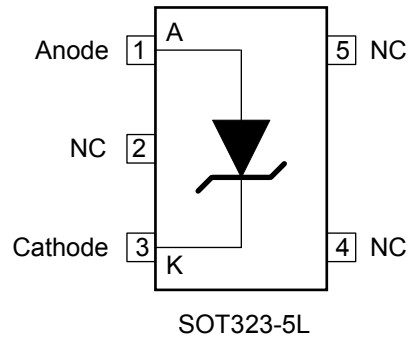

Table 1. Order code

Part number	Cathode-to-anode voltage	Precision	Package	Temperature range
TS4061VIBT-205	2.048 V	0.2%	SOT323-5L	-40 to +85 °C

2 Maximum ratings

Table 2. Absolute maximum ratings

Symbol	Parameter	Value	Unit
I_k	Reverse breakdown current	20	mA
I_f	Forward current	15	mA
P_d	Power dissipation ⁽¹⁾ SOT323-5L	500	mW
T_{std}	Storage temperature	-65 to +150	°C
ESD	Human body model (HBM)	2	kV
	Charged device model	1500	V
T_{lead}	Lead temperature (Soldering) 10 s.	260	°C
T_j	Max junction temperature	+150	°C

1. P_d has been calculated with $T_{amb} = 25\text{ °C}$ and $T_{jmax} = 150\text{ °C}$

Note: Absolute maximum ratings are those values beyond which damage to the device may occur. Functional operation under these conditions is not implied.

Table 3. Thermal data

Symbol	Parameter	Value	Unit
R_{thJA}	Thermal resistance junction-ambient	250	°C/W
R_{thJC}	Thermal resistance junction-case	171	°C/W

Table 4. Operating conditions

Symbol	Parameter	Value	Unit
I_{kmin}	Minimum operating current	10	μA
I_{kmax}	Maximum operating current	15	mA
T_{oper}	Operating free air temperature range	-40 to +85	°C

3 Typical application circuit

Figure 2. Application circuit

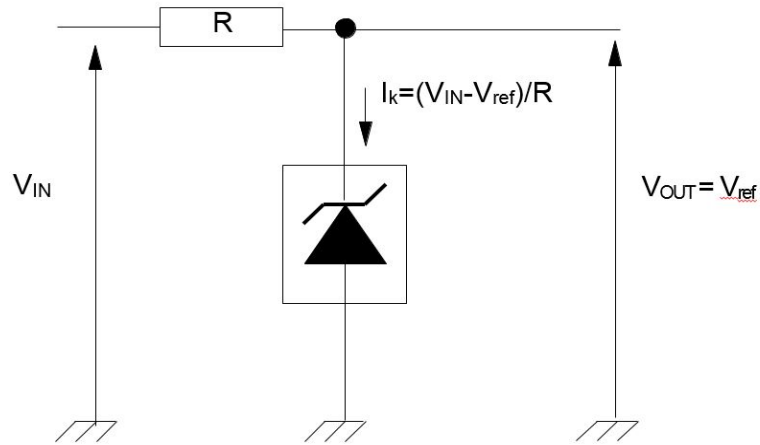

Note: The value of R must be chosen in order to ensure $I_K \geq I_{Kmin}$ in all the operating conditions (V_{IN} , load and temperature).

4 Electrical characteristics

$I_k = 10 \mu\text{A}$, $T_{\text{amb}} = 25 \text{ }^\circ\text{C}$ (unless otherwise specified).

Table 5. Electrical characteristics

Symbol	Parameter	Test conditions	Min.	Typ.	Max.	Unit
V_k	Initial accuracy TS4061VIBT-205	$I_k = 10 \mu\text{A}$	-0.2		+0.2	%
$I_{k\text{min}}$	Minimum operating current	$T_{\text{amb}} = 25 \text{ }^\circ\text{C}$		7.5	10	μA
		$-40 \text{ }^\circ\text{C} < T_{\text{amb}} < +85 \text{ }^\circ\text{C}$			12	
$\Delta V_k / \Delta T$	Average temperature coefficient	$10 \mu\text{A} < I_k < 15 \text{ mA}$, $-40 \text{ }^\circ\text{C} < T_{\text{amb}} < +85 \text{ }^\circ\text{C}$		20	70	ppm/ $^\circ\text{C}$
$\Delta V_k / \Delta I_k$	Reverse breakdown voltage change with operating current range	$I_{k\text{min}} < I_k < 1 \text{ mA}$ $-40 \text{ }^\circ\text{C} < T_{\text{amb}} < +85 \text{ }^\circ\text{C}$		0.2	1	mV
		$1 \text{ mA} < I_k < 15 \text{ mA}$ $-40 \text{ }^\circ\text{C} < T_{\text{amb}} < +85 \text{ }^\circ\text{C}$		1.7	4	
R_{ka}	Static impedance	$I_k = 10 \mu\text{A}$ to 10 mA		0.15	0.3	Ω
Hys	Thermal hysteresis	$I_k = 10 \mu\text{A}$		120		ppm
Noise	Wide band noise	$I_k = 10 \mu\text{A}$ $10 \text{ Hz} < f < 10 \text{ kHz}$		90		μV_{RMS}
	Low frequency noise	$I_k = 10 \mu\text{A}$ $0.1 \text{ Hz} < f < 10 \text{ Hz}$		45		$\mu\text{V}_{\text{p-p}}$

Note: Limits are 100% production tested at 25 °C. Limits overtemperature are guaranteed through correlation and by design.

5 Typical performance characteristics

The following plots are referred to the typical application circuit and, unless otherwise noted, at $T_A = 25\text{ }^\circ\text{C}$.

Figure 3. Cathode voltage vs. temperature ($I_K = 10\text{ }\mu\text{A}$)

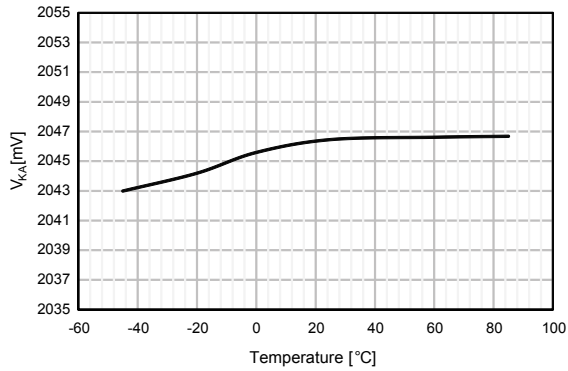

Figure 4. Cathode voltage vs. temperature ($I_K = 1\text{ mA}$)

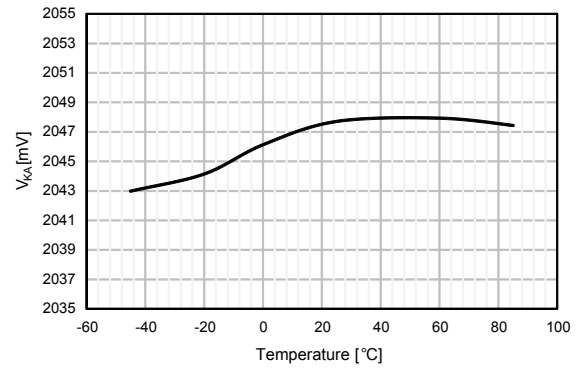

Figure 5. Cathode voltage vs. temperature ($I_K = 15\text{ mA}$)

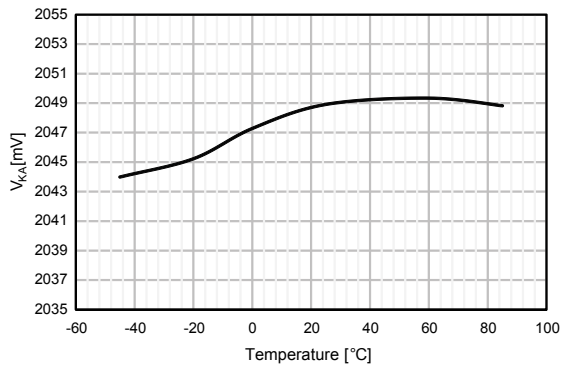

Figure 6. Static impedance vs. temperature

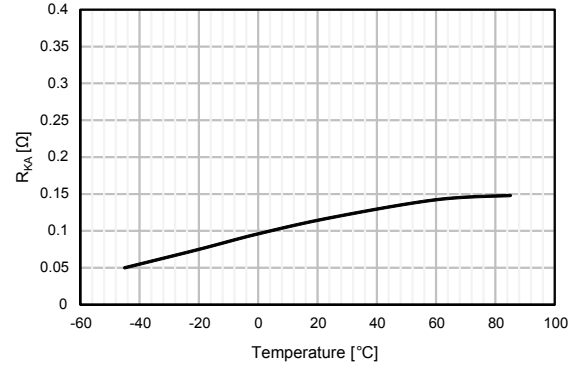

Figure 7. $\Delta V_K / \Delta I_K$ vs. temperature ($I_K = 8\text{ }\mu\text{A}$ to 1 mA)

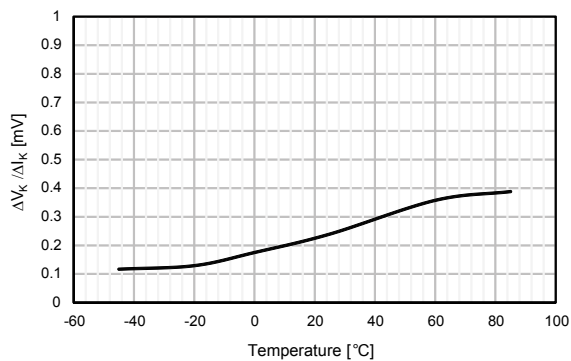

Figure 8. $\Delta V_K / \Delta I_K$ vs. temperature ($I_K = 1\text{ mA}$ to 15 mA)

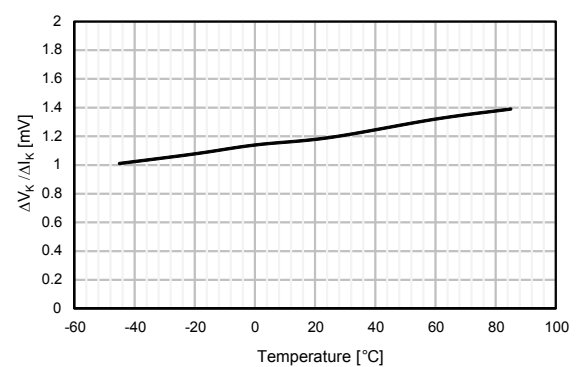

Figure 9. Minimum operating cathode current vs. temperature

Figure 10. Reverse characteristic

Figure 11. Forward characteristic

Figure 12. Temperature coefficient

Figure 13. Turn-on transient ($t_{rise} = 10 \mu s$, no C_{OUT})

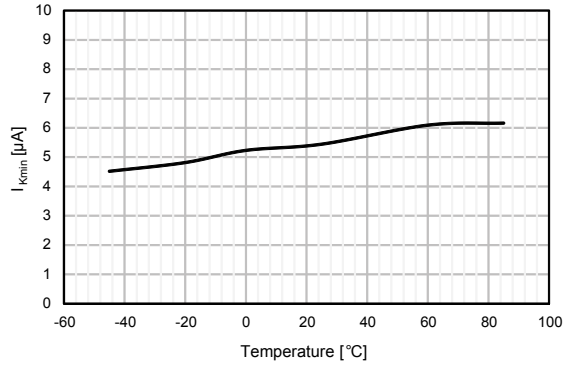
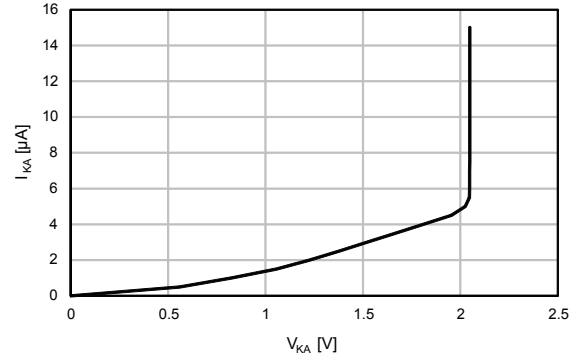
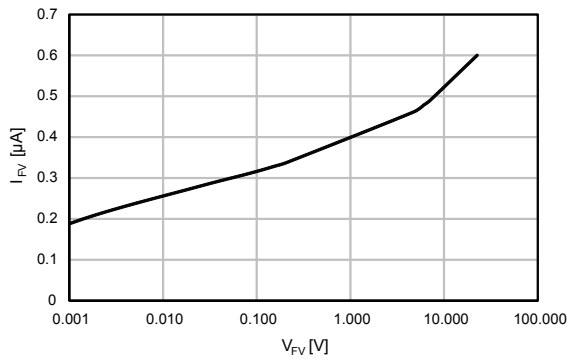
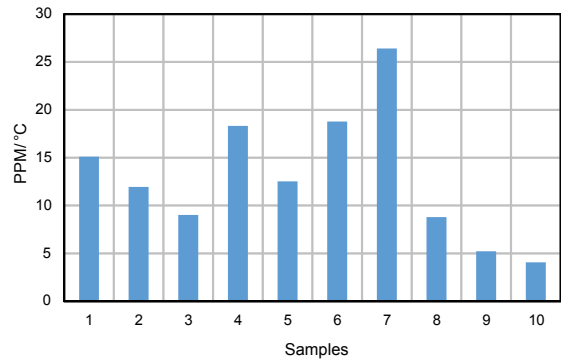
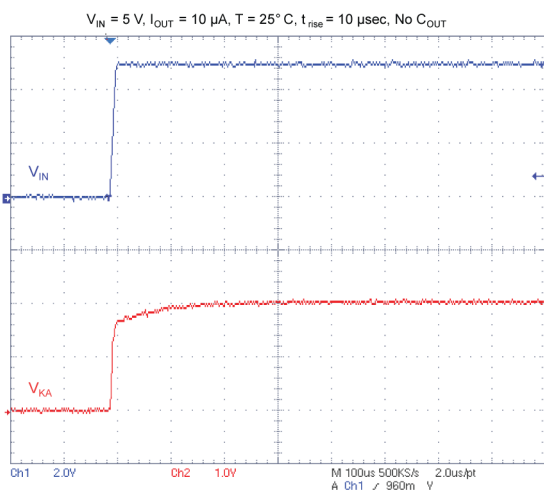
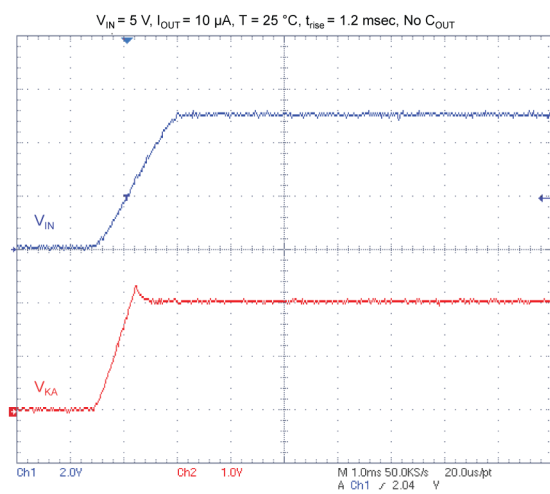
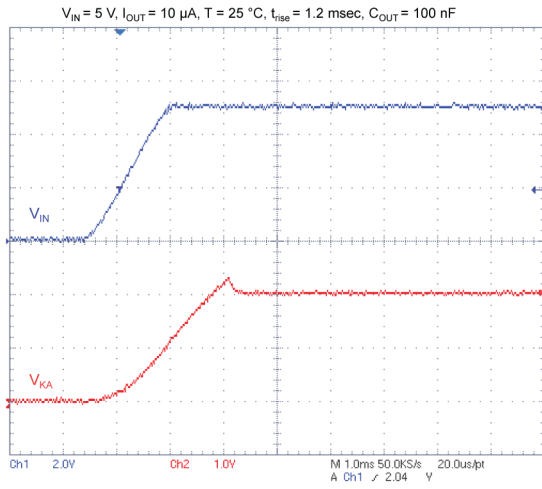
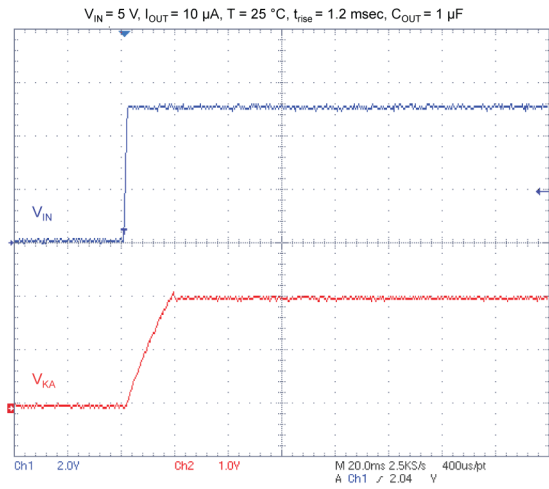
Figure 14. Turn-on transient ($t_{rise} = 1.2 ms$, no C_{OUT})

Figure 15. Turn-on transient ($t_{rise} = 1.2\text{ ms}$, $C_{OUT} = 100\text{ nF}$)

Figure 16. Turn-on transient ($t_{rise} = 1.2\text{ ms}$, $C_{OUT} = 1\text{ }\mu\text{F}$)

6 Package information

In order to meet environmental requirements, ST offers these devices in different grades of ECOPACK[®] packages, depending on their level of environmental compliance. ECOPACK[®] specifications, grade definitions and product status are available at: www.st.com. ECOPACK[®] is an ST trademark.

6.1 SOT323-5L package information

Figure 17. SOT323-5L package outline

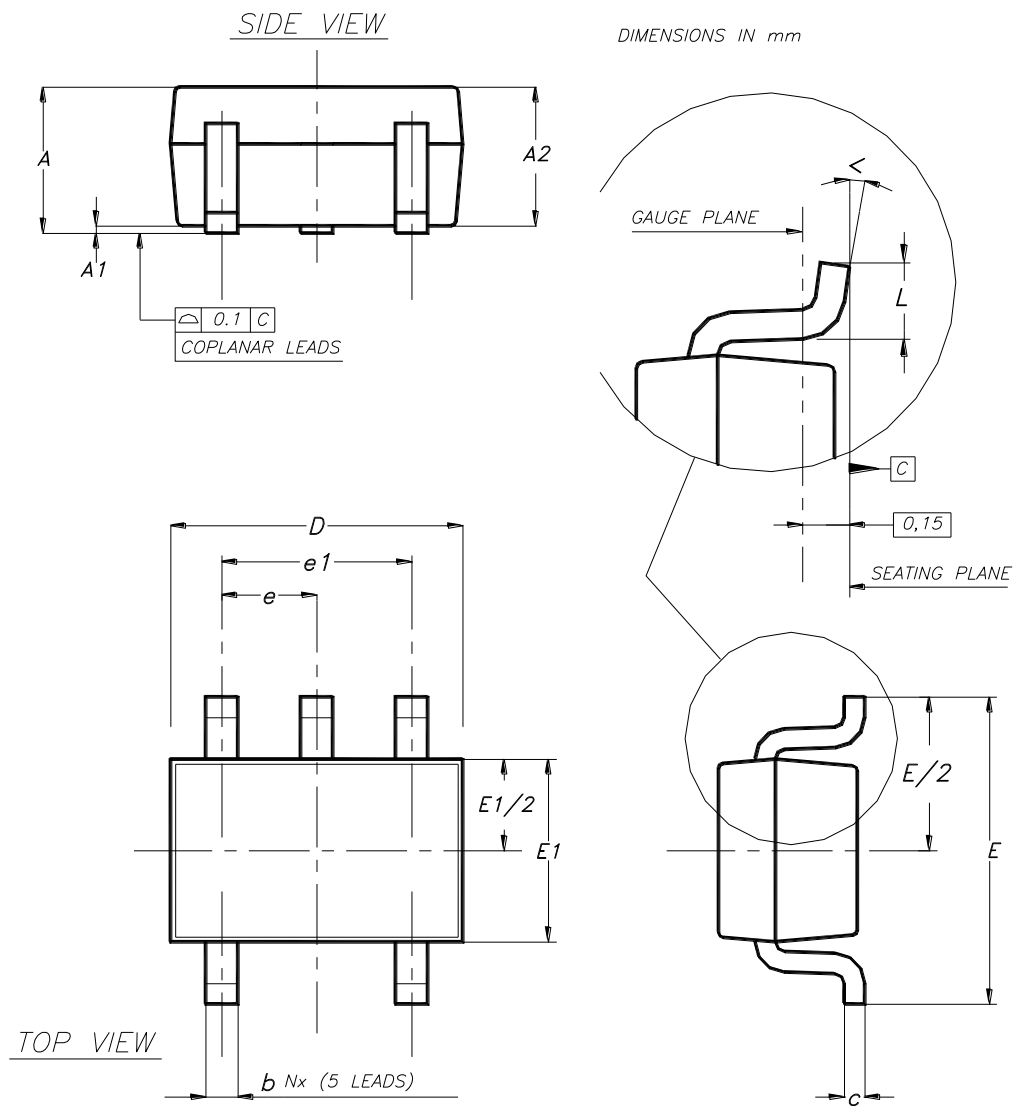

Table 6. SOT323-5L package mechanical data

Dim.	mm		
	Min.	Typ.	Max.
A	0.80		1.10
A1	0		0.10
A2	0.80	0.90	1.00
b	0.15		0.30
c	0.10		0.22
D	1.80	2.00	2.20
E	1.80	2.10	2.40
E1	1.15	1.25	1.35
e		0.65	
e1		1.30	
L	0.26	0.36	0.46
θ	0°		8°

Revision history

Table 7. Document revision history

Date	Revision	Changes
07-Jun-2018	1	Initial release.

Contents

1	Pin configuration	2
2	Maximum ratings	3
3	Typical application circuit	4
4	Electrical characteristics	5
5	Typical performance characteristics	6
6	Package information	9
6.1	SOT323-5L package information	9
	Revision history	11

List of tables

Table 1.	Order code	2
Table 2.	Absolute maximum ratings	3
Table 3.	Thermal data	3
Table 4.	Operating conditions	3
Table 5.	Electrical characteristics	5
Table 6.	SOT323-5L package mechanical data	10
Table 7.	Document revision history	11

List of figures

Figure 1.	Pin connections (top view)	2
Figure 2.	Application circuit	4
Figure 3.	Cathode voltage vs. temperature ($I_K = 10 \mu A$)	6
Figure 4.	Cathode voltage vs. temperature ($I_K = 1 mA$)	6
Figure 5.	Cathode voltage vs. temperature ($I_K = 15 mA$)	6
Figure 6.	Static impedance vs. temperature	6
Figure 7.	$\Delta V_K / \Delta I_K$ vs. temperature ($I_K = 8 \mu A$ to $1 mA$)	6
Figure 8.	$\Delta V_K / \Delta I_K$ vs. temperature ($I_K = 1 mA$ to $15 mA$)	6
Figure 9.	Minimum operating cathode current vs. temperature	7
Figure 10.	Reverse characteristic	7
Figure 11.	Forward characteristic	7
Figure 12.	Temperature coefficient	7
Figure 13.	Turn-on transient ($t_{rise} = 10 \mu s$, no C_{OUT})	7
Figure 14.	Turn-on transient ($t_{rise} = 1.2 ms$, no C_{OUT})	7
Figure 15.	Turn-on transient ($t_{rise} = 1.2 ms$, $C_{OUT} = 100 nF$)	8
Figure 16.	Turn-on transient ($t_{rise} = 1.2 ms$, $C_{OUT} = 1 \mu F$)	8
Figure 17.	SOT323-5L package outline	9

IMPORTANT NOTICE – PLEASE READ CAREFULLY

STMicroelectronics NV and its subsidiaries (“ST”) reserve the right to make changes, corrections, enhancements, modifications, and improvements to ST products and/or to this document at any time without notice. Purchasers should obtain the latest relevant information on ST products before placing orders. ST products are sold pursuant to ST’s terms and conditions of sale in place at the time of order acknowledgement.

Purchasers are solely responsible for the choice, selection, and use of ST products and ST assumes no liability for application assistance or the design of Purchasers’ products.

No license, express or implied, to any intellectual property right is granted by ST herein.

Resale of ST products with provisions different from the information set forth herein shall void any warranty granted by ST for such product.

ST and the ST logo are trademarks of ST. All other product or service names are the property of their respective owners.

Information in this document supersedes and replaces information previously supplied in any prior versions of this document.

© 2018 STMicroelectronics – All rights reserved