

# General-Purpose Rectifiers

## S1A - S1M

### Description

In the world of commodity rectifiers, onsemi S1 family of 1 A, P-I-N, SMA rectifiers stand out for their optimized low leakage, low capacitance, and fast response time. This was achieved while maintaining the industry standard  $V_F$  max of 1.1 V at 1 A and a 30 A surge rating. In today's world, where system power efficiency is a critical differentiating feature, these advantages can be leveraged to support those higher efficiency goals.

### Features

- 1  $A_{I(F(AV))}$  Current Rating
- Glass Passivated
- Low Leakage:
  - ◆ 1  $\mu A$  Maximum at 25°C
  - ◆ 50  $\mu A$  Maximum at 125°C
- Fast Response: 1.8  $\mu s$  (Typical)
- 30 A Surge Rating
- 50 V to 1000 V Reverse Voltage Ratings
- 6.6 pF Typical Capacitance
- UL Certified, UL #E258596
- These Devices are Pb-Free, Halogen Free/BFR Free and are RoHS Compliant

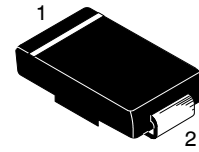

SMA  
CASE 403AE

### MARKING DIAGRAM

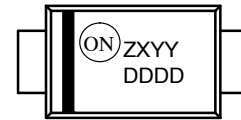

- Z = Assembly Plant Code
- X = Last Digit of Year of Manufacture
- YY = Weekly Code of Manufacture
- DDDD = Specific Device Code

### ORDERING INFORMATION

Part Number	Device Code Marking	Package	Shipping†
S1A	S1A	DO-214AC (SMA) (Pb-Free)	7500 / Tape & Reel
S1B	S1B		7500 / Tape & Reel
S1D	S1D		7500 / Tape & Reel
S1G	S1G		7500 / Tape & Reel
S1J	S1J		7500 / Tape & Reel
S1K	S1K		7500 / Tape & Reel
S1M	S1M		7500 / Tape & Reel

†For information on tape and reel specifications, including part orientation and tape sizes, please refer to our Tape and Reel Packaging Specifications Brochure, BRD8011/D.

## S1A – S1M

### ABSOLUTE MAXIMUM RATINGS ( $T_A = 25^\circ\text{C}$ unless otherwise noted) (Note 1)

Symbol	Parameter	Value							Unit
		S1A	S1B	S1D	S1G	S1J	S1K	S1M	
$V_{RRM}$	Maximum Repetitive Reverse Voltage	50	100	200	400	600	800	1000	V
$I_{F(AV)}$	Average Rectified Forward Current at $T_A = 100^\circ\text{C}$	1.0							A
$I_{FSM}$	Non-Repetitive Peak Forward Surge Current 8.3 ms Single Half-Sine-Wave	30							A
$T_{STG}$	Storage Temperature Range	-55 to +150							$^\circ\text{C}$
$T_J$	Operating Junction Temperature	-55 to +150							$^\circ\text{C}$

Stresses exceeding those listed in the Maximum Ratings table may damage the device. If any of these limits are exceeded, device functionality should not be assumed, damage may occur and reliability may be affected.

1. These ratings are limiting values above which the serviceability of any semiconductor device maybe impaired.

### THERMAL CHARACTERISTICS ( $T_A = 25^\circ\text{C}$ unless otherwise noted) (Note 1)

Symbol	Characteristic	Value	Unit
$P_D$	Power Dissipation	1.4	W
$R_{\theta JA}$	Thermal Resistance, Junction to Ambient (Note 2)	85	$^\circ\text{C}/\text{W}$
$R_{\theta JA}$	Thermal Resistance, Junction to Ambient (Note 3)	170	$^\circ\text{C}/\text{W}$
$\Psi_{JL}$	Junction-Lead Thermal Characteristics (Note 3)	25	$^\circ\text{C}/\text{W}$

2. Device mounted on FR-4 PCB, land pattern size: 25 mm<sup>2</sup> (5 x 5 mm).

3. Device mounted on FR-4 PCB, land pattern size: 4.6375 mm<sup>2</sup> (2.65 x 1.75 mm).

### ELECTRICAL CHARACTERISTICS ( $T_A = 25^\circ\text{C}$ unless otherwise noted)

Symbol	Parameter	Conditions	Min	Typ	Max	Unit
$V_F$	Forward Voltage	$I_F = 1.0 \text{ A}$	-	-	1.1	V
$t_{rr}$	Reverse Recovery Time	$I_F = 0.5 \text{ A}$ , $I_R = 1.0 \text{ A}$ $I_{rr} = 0.25 \text{ A}$	-	1.8	-	$\mu\text{s}$
$I_R$	Reverse Current at Rated $V_R$	$T_A = 25^\circ\text{C}$	-	-	1.0	$\mu\text{A}$
		$T_A = 125^\circ\text{C}$	-	-	50	
$C_J$	Junction Capacitance	$V_R = 4.0 \text{ V}$ , $f = 1.0 \text{ MHz}$	-	6.6	-	pF

Product parametric performance is indicated in the Electrical Characteristics for the listed test conditions, unless otherwise noted. Product performance may not be indicated by the Electrical Characteristics if operated under different conditions.

# S1A – S1M

## TYPICAL PERFORMANCE CHARACTERISTICS

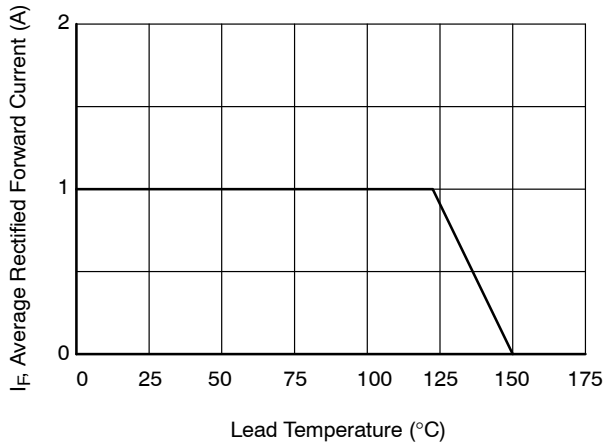

**Figure 1. Forward Current Derating Curve**

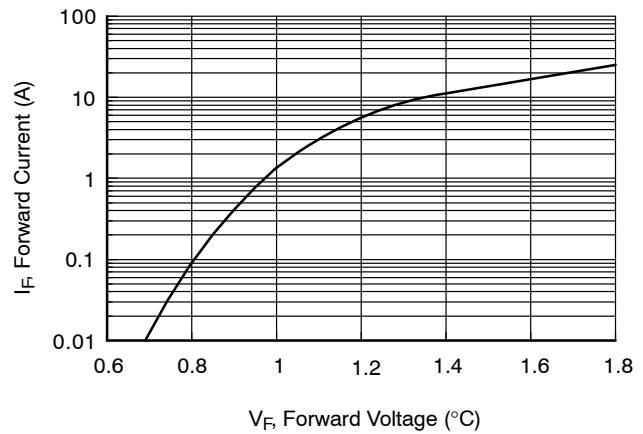

**Figure 2. Forward Voltage Characteristics**

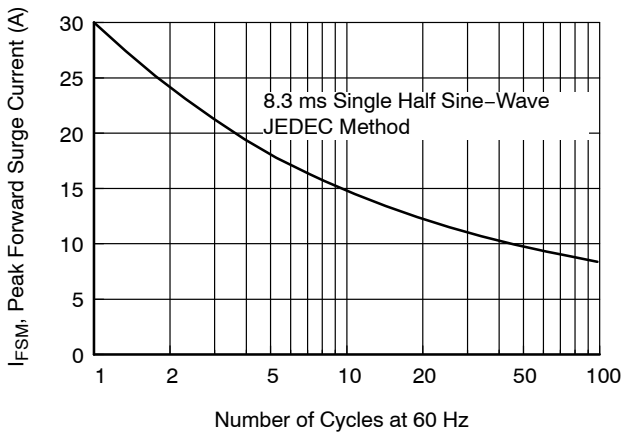

**Figure 3. Non-Repetitive Surge Current**

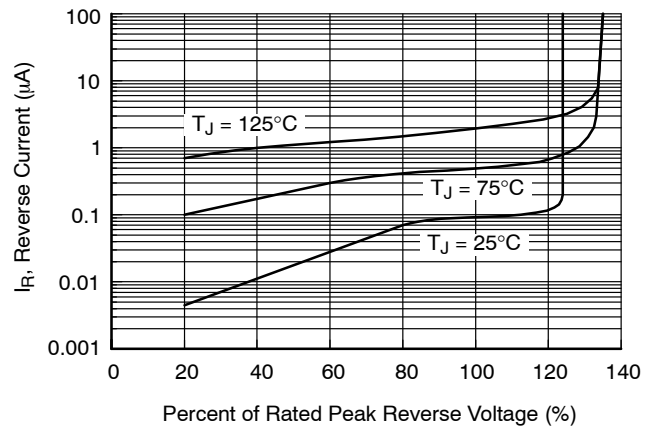

**Figure 4. Reverse Current vs. Reverse Voltage**

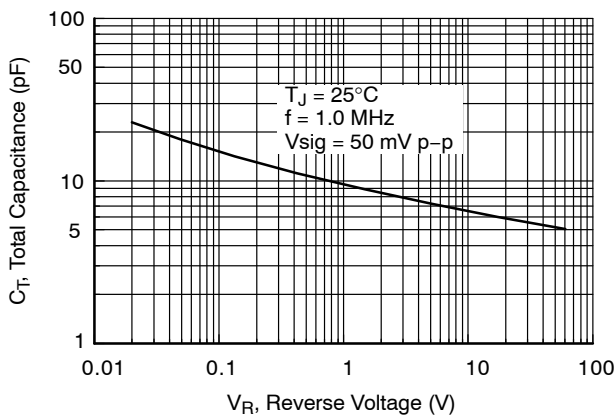

**Figure 5. Total Capacitance**

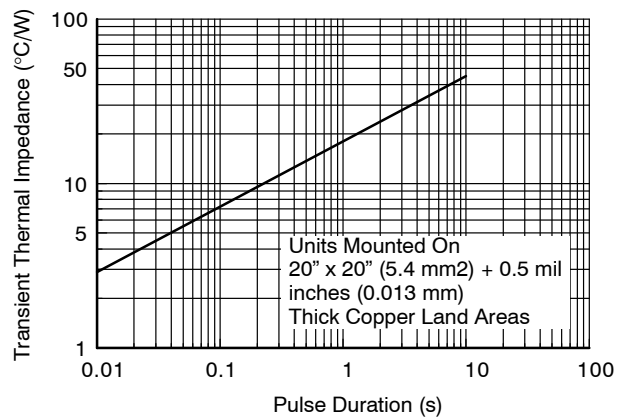

**Figure 6. Thermal Impedance Characteristics**

# MECHANICAL CASE OUTLINE

## PACKAGE DIMENSIONS

ON Semiconductor®



SMA  
CASE 403AE  
ISSUE O

DATE 31 AUG 2016

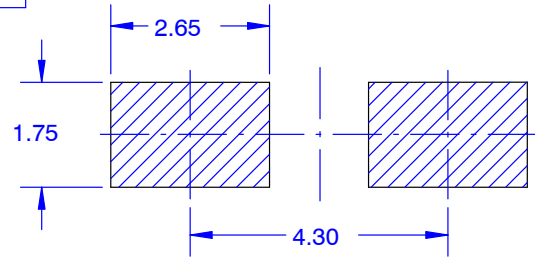

NOTES:

- A. EXCEPT WHERE NOTED, CONFORMS TO JEDEC DO214 VARIATION AC.
- B. DOES NOT COMPLY JEDEC STANDARD VALUE.
- C. ALL DIMENSIONS ARE IN MILLIMETERS.
- D. DIMENSIONS ARE EXCLUSIVE OF BURRS, MOLD FLASH AND TIE BAR PROTRUSIONS.
- E. DIMENSIONS AND TOLERANCE AS PER ASME Y14.5-2009.
- E. LAND PATTERN STD. DIOM5025X231M

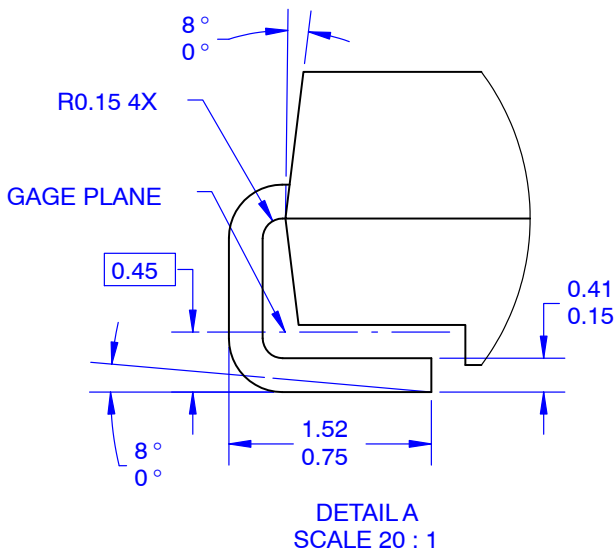

<b>DOCUMENT NUMBER:</b>	<b>98AON13440G</b>	Electronic versions are uncontrolled except when accessed directly from the Document Repository. Printed versions are uncontrolled except when stamped "CONTROLLED COPY" in red.
<b>DESCRIPTION:</b>	<b>SMA</b>	<b>PAGE 1 OF 1</b>

ON Semiconductor and are trademarks of Semiconductor Components Industries, LLC dba ON Semiconductor or its subsidiaries in the United States and/or other countries. ON Semiconductor reserves the right to make changes without further notice to any products herein. ON Semiconductor makes no warranty, representation or guarantee regarding the suitability of its products for any particular purpose, nor does ON Semiconductor assume any liability arising out of the application or use of any product or circuit, and specifically disclaims any and all liability, including without limitation special, consequential or incidental damages. ON Semiconductor does not convey any license under its patent rights nor the rights of others.

**onsemi**, **Onsemi**, and other names, marks, and brands are registered and/or common law trademarks of Semiconductor Components Industries, LLC dba "**onsemi**" or its affiliates and/or subsidiaries in the United States and/or other countries. **onsemi** owns the rights to a number of patents, trademarks, copyrights, trade secrets, and other intellectual property. A listing of **onsemi**'s product/patent coverage may be accessed at [www.onsemi.com/site/pdf/Patent-Marking.pdf](http://www.onsemi.com/site/pdf/Patent-Marking.pdf). **onsemi** reserves the right to make changes at any time to any products or information herein, without notice. The information herein is provided "as-is" and **onsemi** makes no warranty, representation or guarantee regarding the accuracy of the information, product features, availability, functionality, or suitability of its products for any particular purpose, nor does **onsemi** assume any liability arising out of the application or use of any product or circuit, and specifically disclaims any and all liability, including without limitation special, consequential or incidental damages. Buyer is responsible for its products and applications using **onsemi** products, including compliance with all laws, regulations and safety requirements or standards, regardless of any support or applications information provided by **onsemi**. "Typical" parameters which may be provided in **onsemi** data sheets and/or specifications can and do vary in different applications and actual performance may vary over time. All operating parameters, including "Typicals" must be validated for each customer application by customer's technical experts. **onsemi** does not convey any license under any of its intellectual property rights nor the rights of others. **onsemi** products are not designed, intended, or authorized for use as a critical component in life support systems or any FDA Class 3 medical devices or medical devices with a same or similar classification in a foreign jurisdiction or any devices intended for implantation in the human body. Should Buyer purchase or use **onsemi** products for any such unintended or unauthorized application, Buyer shall indemnify and hold **onsemi** and its officers, employees, subsidiaries, affiliates, and distributors harmless against all claims, costs, damages, and expenses, and reasonable attorney fees arising out of, directly or indirectly, any claim of personal injury or death associated with such unintended or unauthorized use, even if such claim alleges that **onsemi** was negligent regarding the design or manufacture of the part. **onsemi** is an Equal Opportunity/Affirmative Action Employer. This literature is subject to all applicable copyright laws and is not for resale in any manner.

## PUBLICATION ORDERING INFORMATION

### LITERATURE FULFILLMENT:

Email Requests to: [orderlit@onsemi.com](mailto:orderlit@onsemi.com)

**onsemi Website:** [www.onsemi.com](http://www.onsemi.com)

### TECHNICAL SUPPORT

**North American Technical Support:**

Voice Mail: 1 800-282-9855 Toll Free USA/Canada

Phone: 011 421 33 790 2910

**Europe, Middle East and Africa Technical Support:**

Phone: 00421 33 790 2910

For additional information, please contact your local Sales Representative

