

ON Semiconductor

Is Now

onsemi™

To learn more about onsemi™, please visit our website at
www.onsemi.com

onsemi and **onsemi** and other names, marks, and brands are registered and/or common law trademarks of Semiconductor Components Industries, LLC dba "**onsemi**" or its affiliates and/or subsidiaries in the United States and/or other countries. **onsemi** owns the rights to a number of patents, trademarks, copyrights, trade secrets, and other intellectual property. A listing of **onsemi** product/patent coverage may be accessed at www.onsemi.com/site/pdf/Patent-Marking.pdf. **onsemi** reserves the right to make changes at any time to any products or information herein, without notice. The information herein is provided "as-is" and **onsemi** makes no warranty, representation or guarantee regarding the accuracy of the information, product features, availability, functionality, or suitability of its products for any particular purpose, nor does **onsemi** assume any liability arising out of the application or use of any product or circuit, and specifically disclaims any and all liability, including without limitation special, consequential or incidental damages. Buyer is responsible for its products and applications using **onsemi** products, including compliance with all laws, regulations and safety requirements or standards, regardless of any support or applications information provided by **onsemi**. "Typical" parameters which may be provided in **onsemi** data sheets and/or specifications can and do vary in different applications and actual performance may vary over time. All operating parameters, including "Typicals" must be validated for each customer application by customer's technical experts. **onsemi** does not convey any license under any of its intellectual property rights nor the rights of others. **onsemi** products are not designed, intended, or authorized for use as a critical component in life support systems or any FDA Class 3 medical devices or medical devices with a same or similar classification in a foreign jurisdiction or any devices intended for implantation in the human body. Should Buyer purchase or use **onsemi** products for any such unintended or unauthorized application, Buyer shall indemnify and hold **onsemi** and its officers, employees, subsidiaries, affiliates, and distributors harmless against all claims, costs, damages, and expenses, and reasonable attorney fees arising out of, directly or indirectly, any claim of personal injury or death associated with such unintended or unauthorized use, even if such claim alleges that **onsemi** was negligent regarding the design or manufacture of the part. **onsemi** is an Equal Opportunity/Affirmative Action Employer. This literature is subject to all applicable copyright laws and is not for resale in any manner. Other names and brands may be claimed as the property of others.

MOSFET - Power, Single N-Channel, Shielded Gate, PowerTrench®

150 V, 22 mΩ, 37.2 A



ON Semiconductor®

www.onsemi.com

NTTFS022N15MC

Features

- Small Footprint (3.3 x 3.3 mm) for Compact Design
- Low $R_{DS(on)}$ to Minimize Conduction Losses
- Low Capacitance to Minimize Driver Losses
- These Devices are Pb-Free, Halogen Free/BFR Free and are RoHS Compliant

Typical Applications

- Primary DC-DC MOSFET
- Synchronous Rectifier in DC-DC and AC-DC
- Motor Drive
- Capable of 175°C Tj Max Rating

MAXIMUM RATINGS (T_J = 25°C unless otherwise noted)

Parameter	Symbol	Value	Unit
Drain-to-Source Voltage	V _{DSS}	150	V
Gate-to-Source Voltage	V _{GS}	±20	V
Continuous Drain Current R _{θJC} (Note 5)	Steady State	T _C = 25°C	I _D 37.2 A
		T _C = 25°C	P _D 71.4 W
		T _A = 25°C	I _D 7.4 A
		T _A = 25°C	P _D 2.8 W
		T _A = 25°C	P _D 1.2 W
Pulsed Drain Current (Note 3)	T _C = 25°C	I _{DM} 158	A
Operating Junction and Storage Temperature Range	T _J , T _{stg}	-55 to +175	°C
Single Pulse Drain-to-Source Avalanche Energy (I _{L(pk)} = 8 A) (Note 4)	E _{AS}	96	mJ
Maximum Lead Temperature for Soldering Purposes (1/8" from case for 10 s)	T _L	260	°C

Stresses exceeding those listed in the Maximum Ratings table may damage the device. If any of these limits are exceeded, device functionality should not be assumed, damage may occur and reliability may be affected.

1. Surface mounted on a FR-4 board using 1 in² pad of 2 oz copper.
2. Surface mounted on a FR-4 board using the minimum recommended pad of 2 oz copper.
3. Pulsed ID please refer to Figure 12 SOA graph for more details
4. E_{AS} of 96 mJ is based on starting T_J = 25°C; L = 3 mH, I_{AS} = 8 A, V_{DD} = 150 V, V_{GS} = 10 V.
5. The entire application environment impacts the thermal resistance values shown, they are not constants and are only valid for the particular conditions noted.

V _{(BR)DSS}	R _{DS(on)} MAX	I _D MAX
150 V	22 mΩ @ 10 V	37.2 A

N-CHANNEL MOSFET

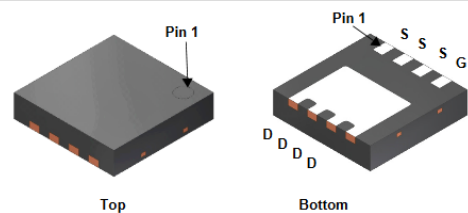
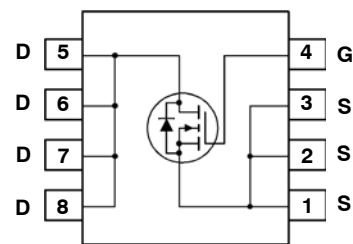

WDFN8
CASE 483AW

MARKING DIAGRAM

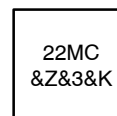

22MC = Specific Device Code
&Z = Assembly Location
&3 = 3-Digit Date Code
&K = Lot Traceability

ORDERING INFORMATION

Device	Package	Shipping†
NTTFS022N15MC	WDFN8 (Pb-Free)	3000 / Tape & Reel

†For information on tape and reel specifications, including part orientation and tape sizes, please refer to our Tape and Reel Packaging Specification Brochure, BRD8011/D.

NTTFS022N15MC

THERMAL CHARACTERISTICS

Parameter	Symbol	Value	Unit
Thermal Resistance Junction-to-Case – Steady State (Note 5)	$R_{\theta JC}$	2.1	$^{\circ}\text{C}/\text{W}$
Thermal Resistance Junction-to-Ambient – Steady State (Notes 1, 5)	$R_{\theta JA}$	53	$^{\circ}\text{C}/\text{W}$
Thermal Resistance Junction-to-Ambient – Steady State (Notes 2, 5)	$R_{\theta JA}$	125	$^{\circ}\text{C}/\text{W}$

ELECTRICAL CHARACTERISTICS ($T_J = 25^{\circ}\text{C}$ unless otherwise noted)

Parameter	Symbol	Test Condition	Min	Typ	Max	Unit
-----------	--------	----------------	-----	-----	-----	------

OFF CHARACTERISTICS

Drain-to-Source Breakdown Voltage	$V_{(BR)DSS}$	$V_{GS} = 0\text{ V}, I_D = 250\ \mu\text{A}$	150			V
Drain-to-Source Breakdown Voltage Temperature Coefficient	$V_{(BR)DSS}/T_J$	$I_D = 250\ \mu\text{A}$, referenced to 25°C		75		$\text{mV}/^{\circ}\text{C}$
Zero Gate Voltage Drain Current	I_{DSS}	$V_{GS} = 0\text{ V}, V_{DS} = 120\text{ V}, T_J = 25^{\circ}\text{C}$			1	μA
Gate-to-Source Leakage Current	I_{GSS}	$V_{GS} = \pm 20\text{ V}, V_{DS} = 0\text{ V}$			± 100	nA

ON CHARACTERISTICS

Gate Threshold Voltage	$V_{GS(TH)}$	$V_{GS} = V_{DS}, I_D = 100\ \mu\text{A}$	2.5		4.5	V
Gate Threshold Temperature Coefficient	$V_{GS(TH)}/T_J$	$I_D = 100\ \mu\text{A}$, referenced to 25°C		-8.4		$\text{mV}/^{\circ}\text{C}$
Drain-to-Source On Resistance	$R_{DS(on)}$	$V_{GS} = 10\text{ V}, I_D = 18\text{ A}$		17.1	22	$\text{m}\Omega$
		$V_{GS} = 8\text{ V}, I_D = 9\text{ A}$		19	25.3	$\text{m}\Omega$
Forward Transconductance	g_{FS}	$V_{DS} = 10\text{ V}, I_D = 18\text{ A}$		37		S

CHARGES, CAPACITANCES & GATE RESISTANCE

Input Capacitance	C_{ISS}	$V_{GS} = 0\text{ V}, f = 1\text{ MHz}$ $V_{DS} = 75\text{ V}$		1315		pF
Output Capacitance	C_{OSS}			380		
Reverse Transfer Capacitance	C_{RSS}			6		
Gate-Resistance	R_G			0.6	1.2	Ω
Total Gate Charge	$Q_{G(TOT)}$	$V_{GS} = 10\text{ V}, V_{DS} = 75\text{ V}, I_D = 18\text{ A}$		17		nC
Threshold Gate Charge	$Q_{G(TH)}$			4.4		
Gate-to-Source Charge	Q_{GS}			7.2		
Gate-to-Drain Charge	Q_{GD}			2.7		
Plateau Voltage	V_{GP}			5.6		
Output Charge	Q_{OSS}	$V_{GS} = 0\text{ V}, V_{DD} = 75\text{ V}$		41		nC

RESISTIVE SWITCHING CHARACTERISTICS (Note 6)

Turn-On Delay Time	$t_{d(on)}$	$V_{GS} = 10\text{ V}, V_{DS} = 75\text{ V},$ $I_D = 18\text{ A}, R_G = 6\ \Omega$		14		ns
Rise Time	t_r			2.8		
Turn-Off Delay Time	$t_{d(off)}$			17		
Fall Time	t_f			2.9		

DRAIN-SOURCE DIODE CHARACTERISTICS

Forward Diode Voltage	V_{SD}	$V_{GS} = 0\text{ V}, I_S = 18\text{ A}, T_J = 25^{\circ}\text{C}$		0.86	1.2	V
Reverse Recovery Time	t_{RR}	$V_{GS} = 0\text{ V}, V_{DD} = 75\text{ V}$ $di_S/dt = 300\text{ A}/\mu\text{s}, I_S = 18\text{ A}$		45		ns
Reverse Recovery Charge	Q_{RR}			155		nC
Reverse Recovery Time	t_{RR}	$V_{GS} = 0\text{ V}, V_{DD} = 75\text{ V}$ $di_S/dt = 1000\text{ A}/\mu\text{s}, I_S = 18\text{ A}$		28		ns
Reverse Recovery Charge	Q_{RR}			242		nC

Product parametric performance is indicated in the Electrical Characteristics for the listed test conditions, unless otherwise noted. Product performance may not be indicated by the Electrical Characteristics if operated under different conditions.

6. Switching characteristics are independent of operating junction temperature

TYPICAL CHARACTERISTICS

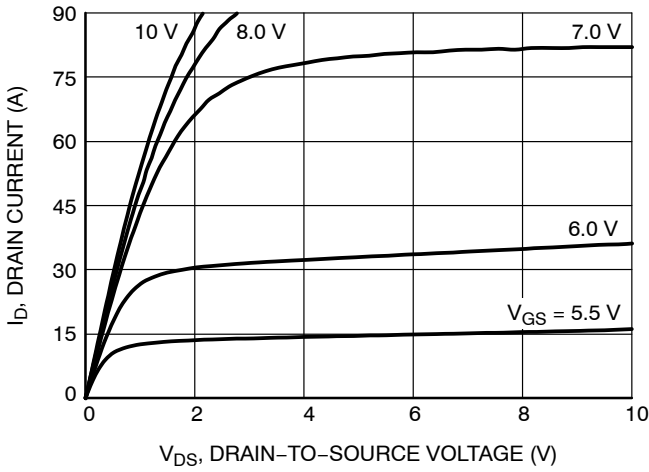

Figure 1. On-Region Characteristics

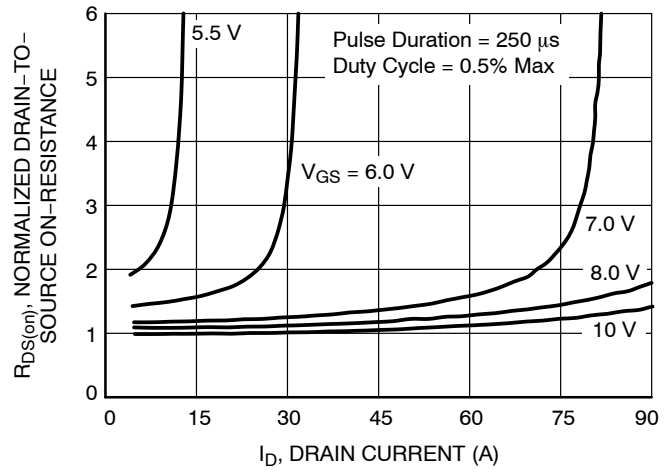

Figure 2. Normalized On-Resistance vs. Drain Current and Gate Voltage

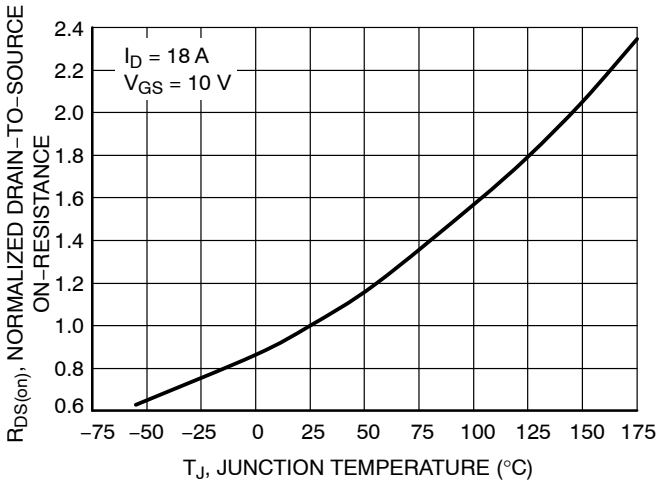

Figure 3. Normalized On-Resistance vs. Junction Temperature

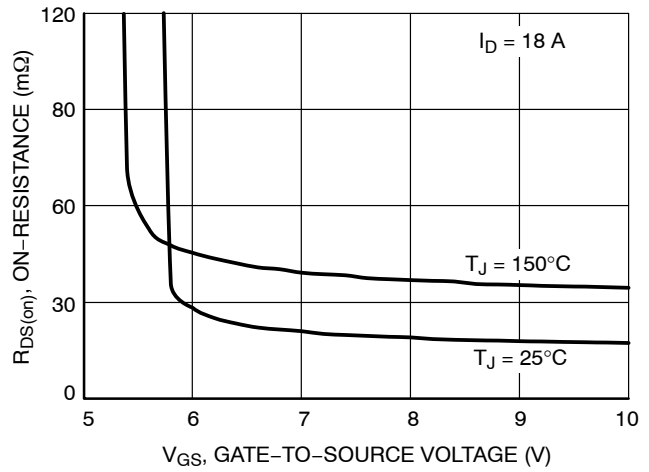

Figure 4. On-Resistance vs. Gate-to-Source Voltage

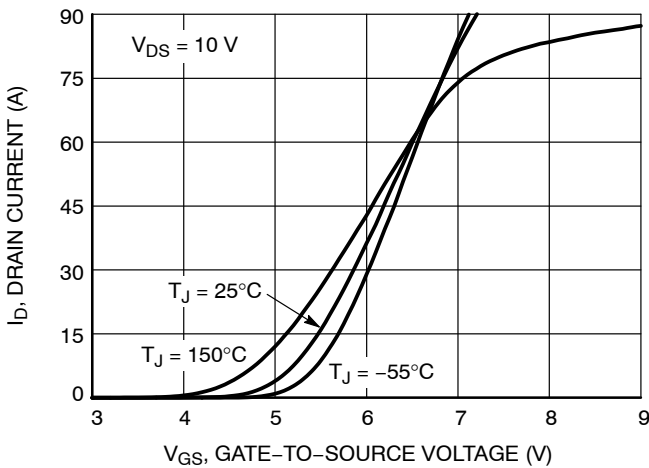

Figure 5. Transfer Characteristics

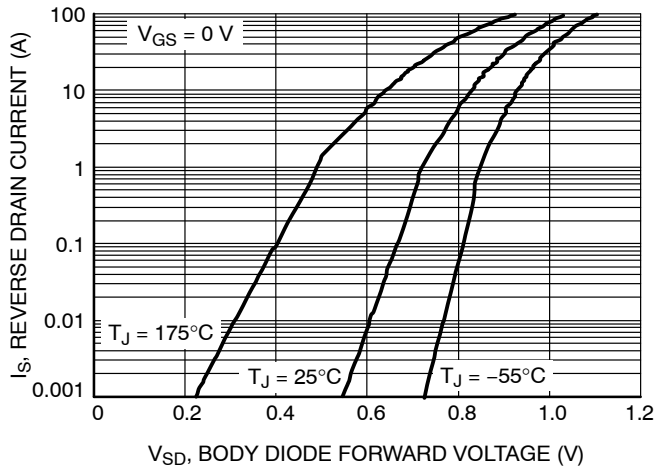

Figure 6. Source-to-Drain Diode Forward Voltage vs. Source Current

NTTFS022N15MC

TYPICAL CHARACTERISTICS

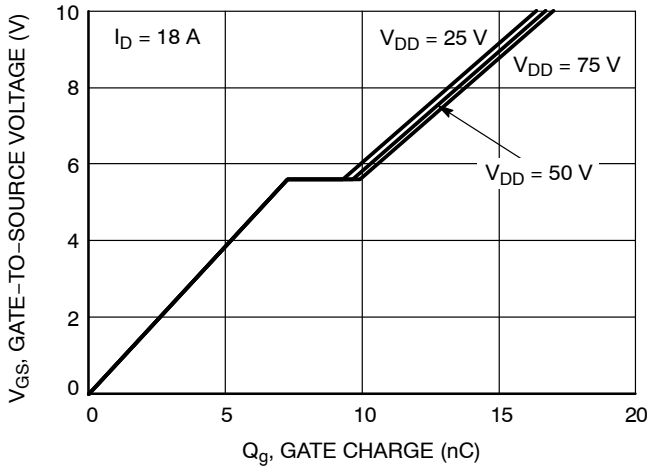

Figure 7. Gate Charge Characteristics

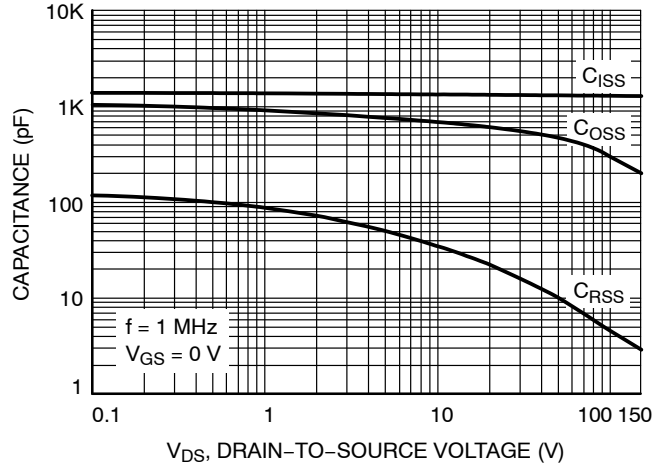

Figure 8. Capacitance vs. Drain-to-Source Voltage

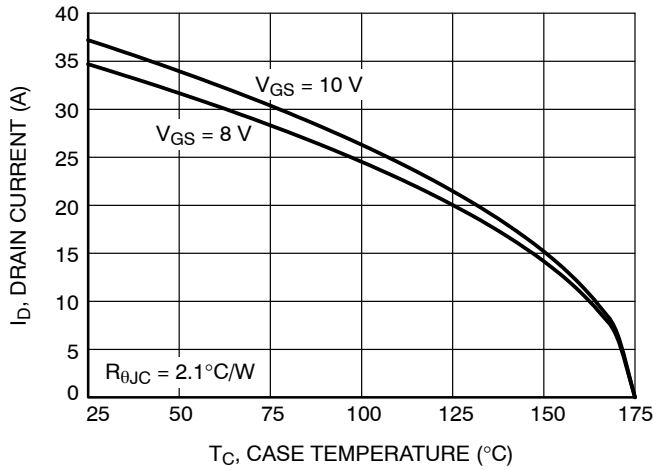

Figure 9. Drain Current vs. Case Temperature

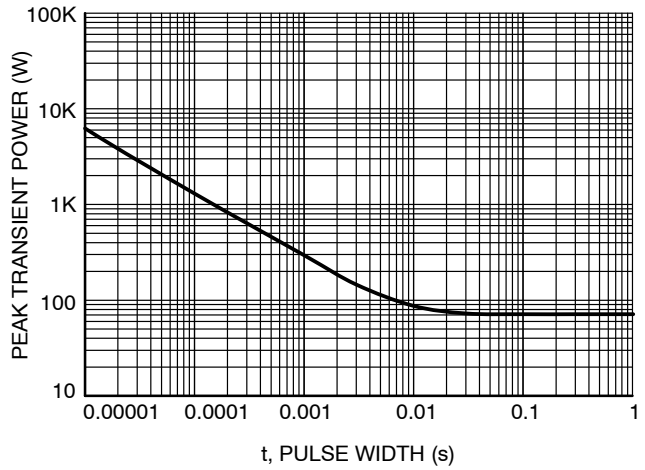

Figure 10. Peak Power

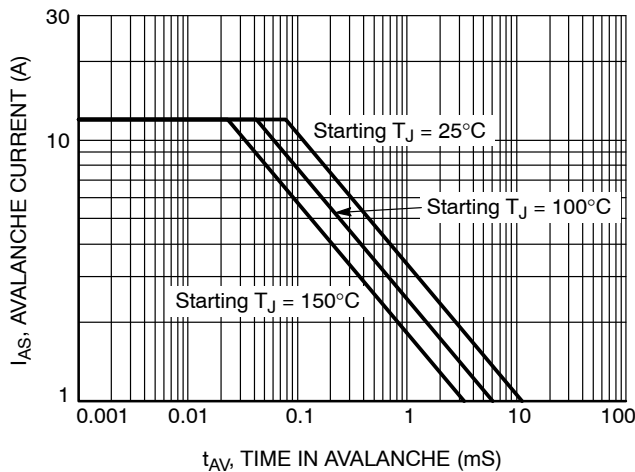

Figure 11. Unclamped Inductive Switching Capability

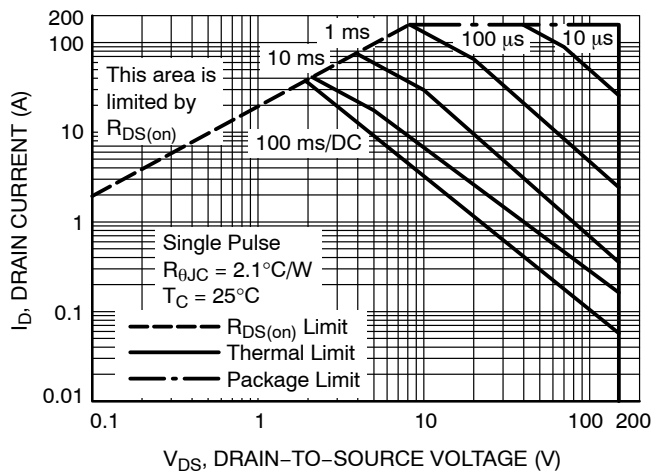

Figure 12. Forward Bias Safe Operating Area

NTTFS022N15MC

TYPICAL CHARACTERISTICS

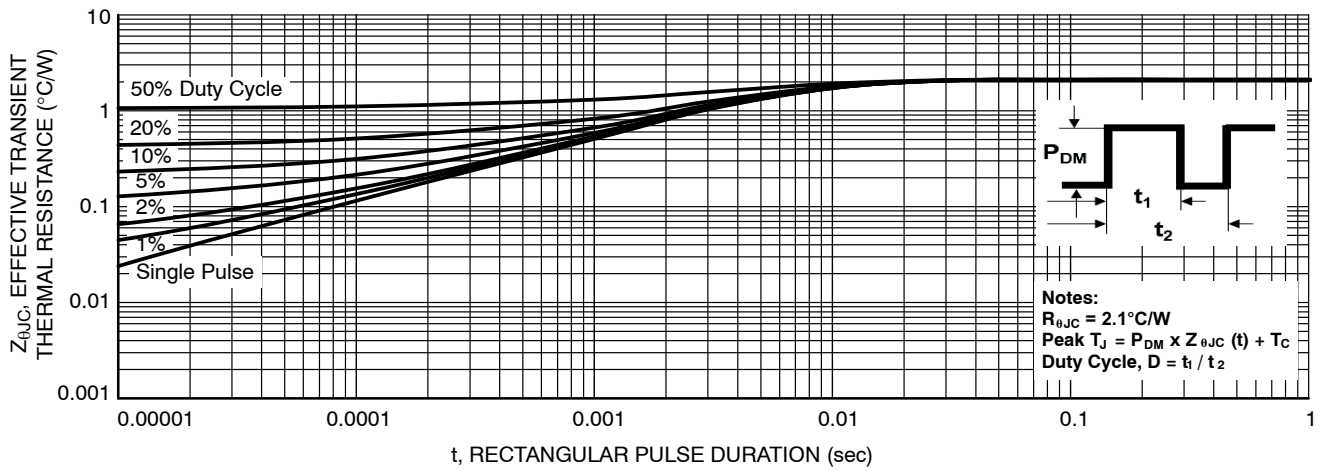
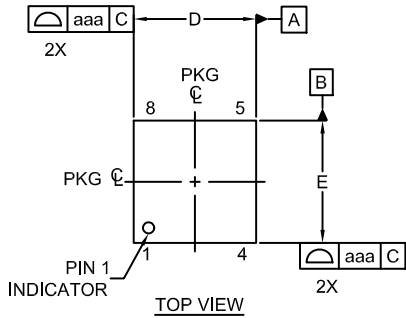

Figure 13. Transient Thermal Impedance

NTTFS022N15MC

PACKAGE DIMENSIONS

WDFN8 3.3X3.3, 0.65P
CASE 483AW
ISSUE A



TOP VIEW

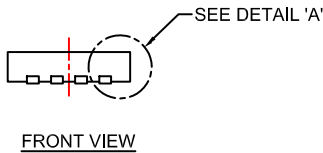

FRONT VIEW

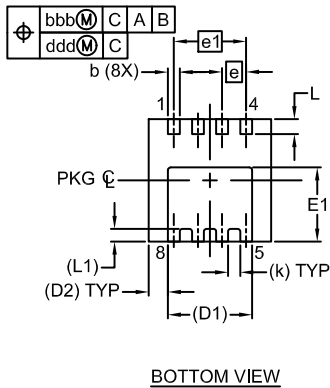

BOTTOM VIEW

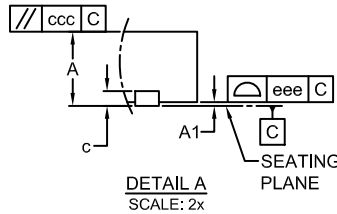

DETAIL A
SCALE: 2x

LAND PATTERN RECOMMENDATION*

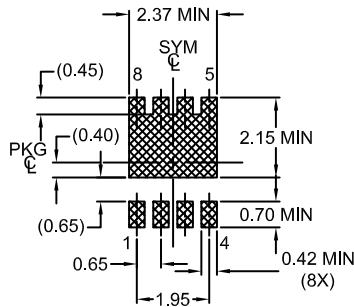

*FOR ADDITIONAL INFORMATION ON OUR PB-FREE STRATEGY AND SOLDERING DETAILS, PLEASE DOWNLOAD THE ON SEMICONDUCTOR SOLDERING AND MOUNTING TECHNIQUES REFERENCE MANUAL, SOLDDRRM/D.

NOTES:

1. CONTROLLING DIMENSION: MILLIMETERS.
2. COPLANARITY APPLIES TO THE EXPOSED PADS AS WELL AS THE TERMINALS.
3. DIMENSIONS D AND E DO NOT INCLUDE MOLD FLASH, PROTRUSIONS OR GATE BURRS.
4. SEATING PLANE IS DEFINED BY THE TERMINALS. 'A1' IS DEFINED AS THE DISTANCE FROM THE SEATING PLANE TO THE LOWEST POINT ON THE PACKAGE BODY.

DIM	MILLIMETERS		
	MIN	NOM	MAX
A	0.70	0.75	0.80
A1	-	-	0.05
b	0.27	0.32	0.37
c	0.15	0.20	0.25
D	3.20	3.30	3.40
D1	2.27 REF		
D2	0.52 REF		
E	3.20	3.30	3.40
E1	1.85	1.95	2.05
e	0.65 BSC		
e1	1.95 BSC		
k	0.33 REF		
L	0.30	0.40	0.50
L1	0.34 REF		
aaa	0.10		
bbb	0.10		
ccc	0.10		
ddd	0.05		
eee	0.05		

ON Semiconductor and are trademarks of Semiconductor Components Industries, LLC dba ON Semiconductor or its subsidiaries in the United States and/or other countries. ON Semiconductor owns the rights to a number of patents, trademarks, copyrights, trade secrets, and other intellectual property. A listing of ON Semiconductor's product/patent coverage may be accessed at www.onsemi.com/site/pdf/Patent-Marking.pdf. ON Semiconductor reserves the right to make changes without further notice to any products herein. ON Semiconductor makes no warranty, representation or guarantee regarding the suitability of its products for any particular purpose, nor does ON Semiconductor assume any liability arising out of the application or use of any product or circuit, and specifically disclaims any and all liability, including without limitation special, consequential or incidental damages. Buyer is responsible for its products and applications using ON Semiconductor products, including compliance with all laws, regulations and safety requirements or standards, regardless of any support or applications information provided by ON Semiconductor. "Typical" parameters which may be provided in ON Semiconductor data sheets and/or specifications can and do vary in different applications and actual performance may vary over time. All operating parameters, including "Typicals" must be validated for each customer application by customer's technical experts. ON Semiconductor does not convey any license under its patent rights nor the rights of others. ON Semiconductor products are not designed, intended, or authorized for use as a critical component in life support systems or any FDA Class 3 medical devices or medical devices with a same or similar classification in a foreign jurisdiction or any devices intended for implantation in the human body. Should Buyer purchase or use ON Semiconductor products for any such unintended or unauthorized application, Buyer shall indemnify and hold ON Semiconductor and its officers, employees, subsidiaries, affiliates, and distributors harmless against all claims, costs, damages, and expenses, and reasonable attorney fees arising out of, directly or indirectly, any claim of personal injury or death associated with such unintended or unauthorized use, even if such claim alleges that ON Semiconductor was negligent regarding the design or manufacture of the part. ON Semiconductor is an Equal Opportunity/Affirmative Action Employer. This literature is subject to all applicable copyright laws and is not for resale in any manner.

PUBLICATION ORDERING INFORMATION

LITERATURE FULFILLMENT:
 Email Requests to: orderlit@onsemi.com

TECHNICAL SUPPORT
 North American Technical Support:
 Voice Mail: 1 800-282-9855 Toll Free USA/Canada
 Phone: 011 421 33 790 2910

Europe, Middle East and Africa Technical Support:
 Phone: 00421 33 790 2910
 For additional information, please contact your local Sales Representative

ON Semiconductor Website: www.onsemi.com