



DOUBLE CHANNEL HIGH SIDE DRIVER

Table 1. General Features

Type	R _{DS(on)}	I _{lim}	V _{CC}
VND600-E	35 mΩ	25 A	36 V

- DC SHORT CIRCUIT CURRENT: 25 A
- CMOS COMPATIBLE INPUTS
- PROPORTIONAL LOAD CURRENT SENSE
- UNDERVOLTAGE AND OVERVOLTAGE SHUT-DOWN
- OVERVOLTAGE CLAMP
- THERMAL SHUT DOWN
- CURRENT LIMITATION
- VERY LOW STAND-BY POWER DISSIPATION
- PROTECTION AGAINST:
 - LOSS OF GROUND AND LOSS OF V_{CC}
- REVERSE BATTERY PROTECTION (*)
- IN COMPLIANCE WITH THE 2002/95/EC EUROPEAN DIRECTIVE

DESCRIPTION

The VND600-E is a monolithic device made using STMicroelectronics VIPower M0-3 technology. It is intended for driving resistive or inductive loads with one side connected to ground. Active V_{CC} pin voltage clamp protects the device against low energy spikes (see ISO7637 transient compatibility table).

Figure 1. Package

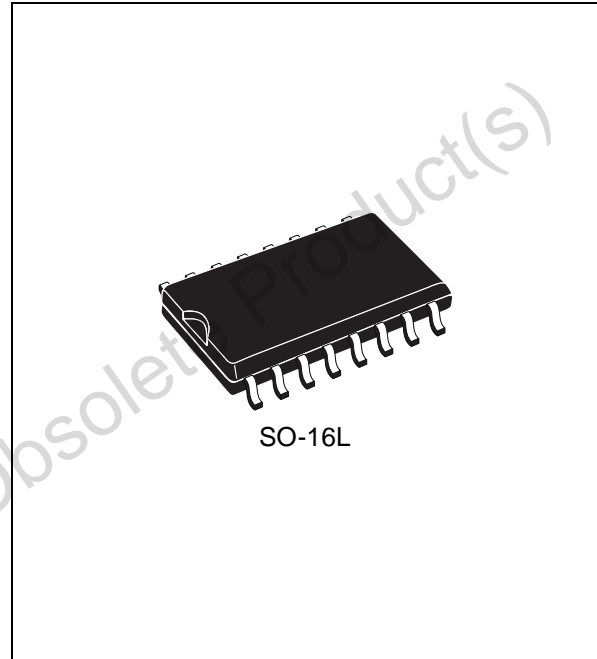

This device has two channels in high side configuration; each channel has an analog sense output on which the sensing current is proportional (according to a known ratio) to the corresponding load current. Built-in thermal shut-down and outputs current limitation protect the chip from over temperature and short circuit. Device turns off in case of ground pin disconnection.

Table 2. Order Codes

Package	Tube	Tape and Reel
SO-16L	VND600-E	VND600TR-E

Note: (*) See application schematic at page 9

Figure 2. Block Diagram

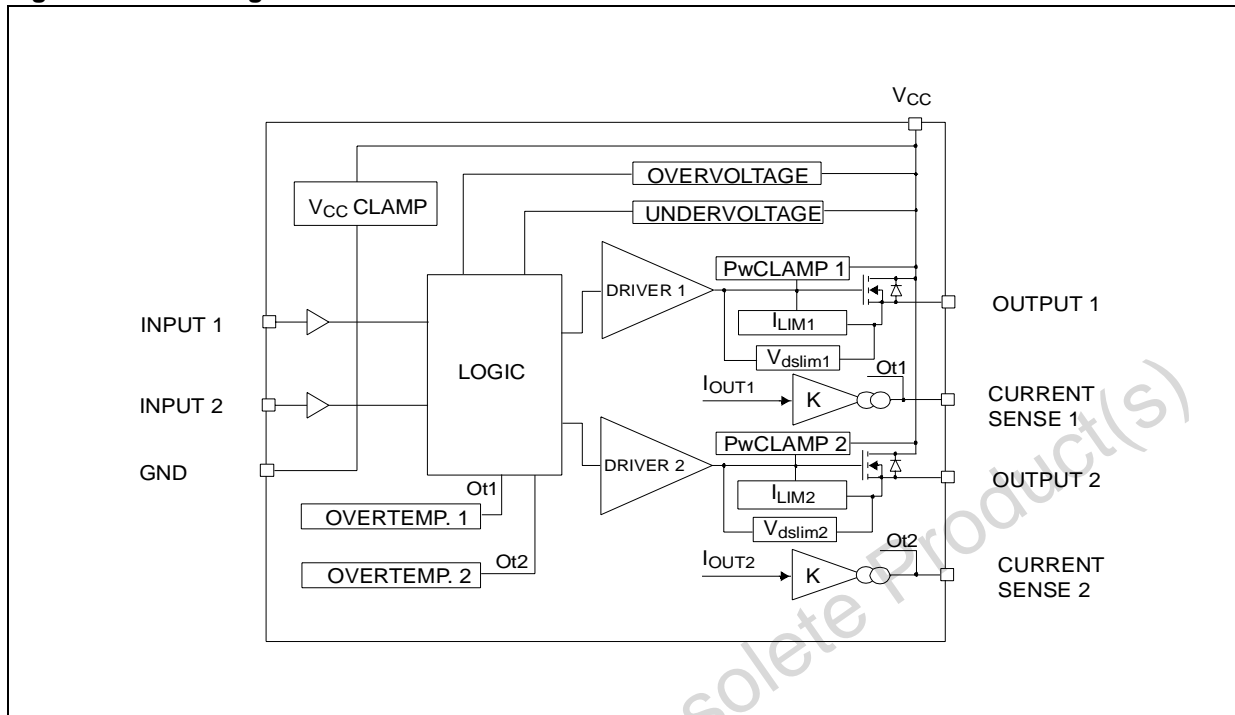

Table 3. Absolute Maximum Ratings

Symbol	Parameter	Value	Unit
V_{CC}	DC supply voltage	41	V
$-V_{CC}$	Reverse supply voltage	-0.3	V
$-I_{GND}$	DC reverse ground pin current	-200	mA
I_{OUT}	Output current	Internally limited	A
I_R	Reverse output current	-21	A
I_{IN}	Input current	+/- 10	mA
V_{ESD}	Electrostatic Discharge (Human Body Model: R=1.5K Ω ; C=100pF)		
	- INPUT	4000	V
	- CURRENT SENSE	2000	V
	- OUTPUT	5000	V
	- V_{CC}	5000	V
E_{MAX}	Maximum Switching Energy (L=0.12mH; $R_L=0\Omega$; $V_{bat}=13.5V$; $T_{jstart}=150^\circ C$; $I_L=40A$)	136	mJ
P_{tot}	Power dissipation at $T_c=25^\circ C$	8.3	W
T_j	Junction operating temperature	Internally limited	$^\circ C$
T_c	Case operating temperature	-40 to 150	$^\circ C$
T_{STG}	Storage temperature	-55 to 150	$^\circ C$

Figure 3. Configuration Diagram (Top View) & Suggested Connections for Unused and N.C. Pins

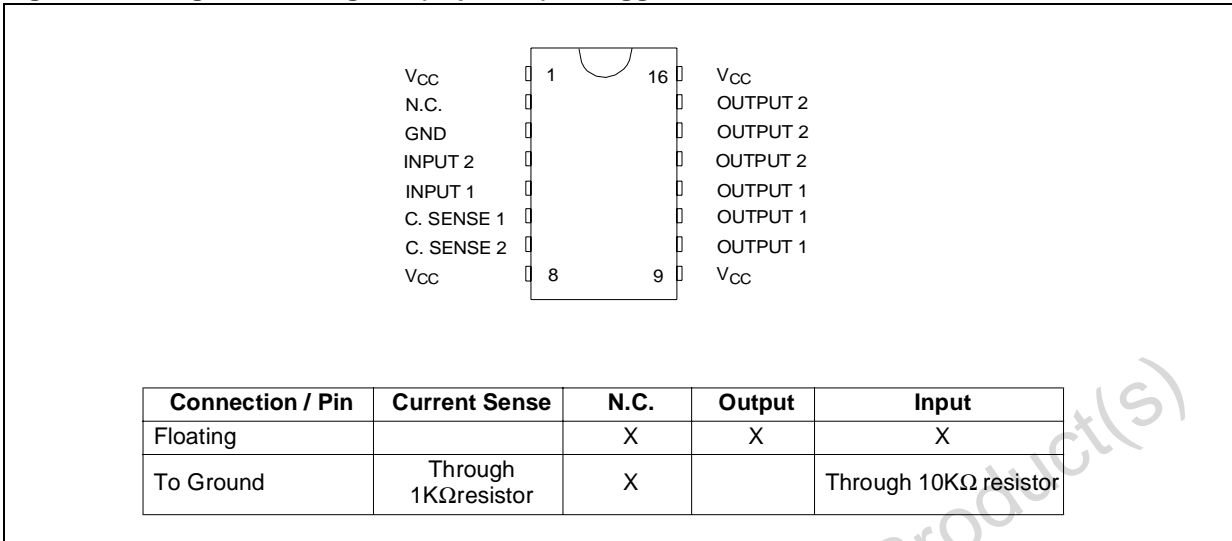

Figure 4. Current and Voltage Conventions

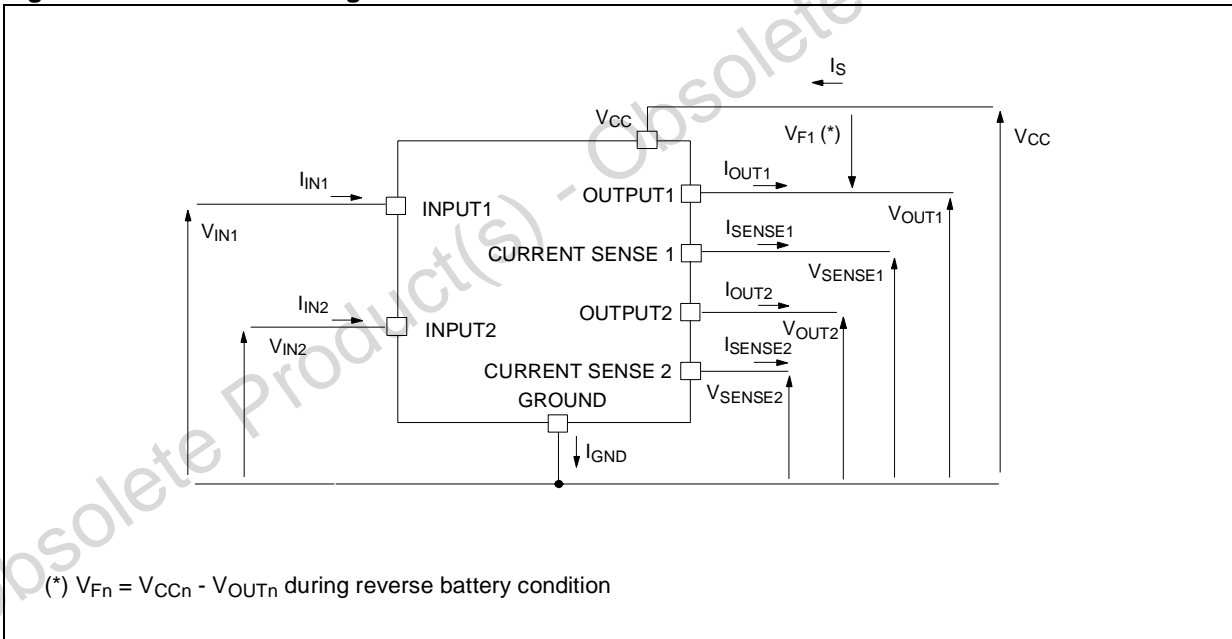

Table 4. Thermal Data

Symbol	Parameter	Value	Unit
R _{thj-lead}	Thermal resistance junction-lead (MAX)	15	°C/W
R _{thj-amb}	Thermal resistance junction-ambient (MAX)	65 (*) 48 (**)	°C/W

Note: (*) When mounted on a standard single-sided FR-4 board with 0.5cm² of Cu (at least 35µm thick). Horizontal mounting and no artificial air flow

Note: (**) When mounted on a standard single-sided FR-4 board with 6cm² of Cu (at least 35µm thick). Horizontal mounting and no artificial air flow.

ELECTRICAL CHARACTERISTICS

($8V < V_{CC} < 36V$; $-40^{\circ}C < T_j < 150^{\circ}C$; unless otherwise specified)

(Per each channel)

Table 5. Power

Symbol	Parameter	Test Conditions	Min.	Typ.	Max.	Unit
V_{CC} (**)	Operating supply voltage		5.5	13	36	V
V_{USD} (**)	Undervoltage shutdown		3	4	5.5	V
V_{OV} (**)	Overvoltage shutdown		36			V
R_{ON}	On state resistance	$I_{OUT}=5A$; $T_j=25^{\circ}C$			35	m Ω
		$I_{OUT}=5A$; $T_j=150^{\circ}C$			70	m Ω
		$I_{OUT}=3A$; $V_{CC}=6V$			120	m Ω
V_{clamp}	Clamp voltage	$I_{CC}=20$ mA (see note 1)	41	48	55	V
I_S (**)	Supply current	Off State; $V_{CC}=13V$; $V_{IN}=V_{OUT}=0V$		12	40	μA
		Off State; $V_{CC}=13V$; $V_{IN}=V_{OUT}=0V$; $T_j=25^{\circ}C$		12	25	μA
		On state; $V_{IN}=5V$; $V_{CC}=13V$; $I_{OUT}=0A$; $R_{SENSE}=3.9k\Omega$			6	mA
$I_{L(off1)}$	Off state output current	$V_{IN}=V_{OUT}=0V$	0		50	μA
$I_{L(off2)}$	Off State Output Current	$V_{IN}=0V$; $V_{OUT}=3.5V$	-75		0	μA
$I_{L(off3)}$	Off State Output Current	$V_{IN}=V_{OUT}=0V$; $V_{CC}=13V$; $T_j=125^{\circ}C$			5	μA
$I_{L(off4)}$	Off State Output Current	$V_{IN}=V_{OUT}=0V$; $V_{CC}=13V$; $T_j=25^{\circ}C$			3	μA

Note: (**) Per device.

Note: 1. V_{clamp} and V_{OV} are correlated. Typical difference is 5V.

Table 6. Protection (Per each channel) (See note 2)

Symbol	Parameter	Test Conditions	Min.	Typ.	Max.	Unit
I_{lim}	DC short circuit current	$V_{CC}=13V$	25	40	70	A
		$5.5V < V_{CC} < 36V$			70	A
T_{TSD}	Thermal shut-down temperature		150	175	200	$^{\circ}C$
T_R	Thermal reset temperature		135			$^{\circ}C$
T_{HYST}	Thermal hysteresis		7	15		$^{\circ}C$
V_{demag}	Turn-off output voltage clamp	$I_{OUT}=2A$; $V_{IN}=0V$; $L=6mH$	$V_{CC}-41$	$V_{CC}-48$	$V_{CC}-55$	V
V_{ON}	Output voltage drop limitation	$I_{OUT}=0.5A$ $T_j= -40^{\circ}C...+150^{\circ}C$		50		mV

Note: 2. To ensure long term reliability under heavy overload or short circuit conditions, protection and related diagnostic signals must be used together with a proper software strategy. If the device is subjected to abnormal conditions, this software must limit the duration and number of activation cycles

Table 7. V_{CC} - Output Diode

Symbol	Parameter	Test Conditions	Min	Typ	Max	Unit
V_F	Forward on Voltage	$-I_{OUT}=2.3A$; $T_j=150^{\circ}C$			0.6	V

ELECTRICAL CHARACTERISTICS (continued)

Table 8. Current Sense CURRENT SENSE ($9V \leq V_{CC} \leq 16V$) (See fig. 6)

Symbol	Parameter	Test Conditions	Min	Typ	Max	Unit
K_1	I_{OUT}/I_{SENSE}	I_{OUT1} or $I_{OUT2}=0.5A$; $V_{SENSE}=0.5V$; other channels open; $T_j=-40^\circ C...150^\circ C$	3300	4400	6000	
dK_1/K_1	Current Sense Ratio Drift	I_{OUT1} or $I_{OUT2}=0.5A$; $V_{SENSE}=0.5V$; other channels open; $T_j=-40^\circ C...150^\circ C$	-10		+10	%
K_2	I_{OUT}/I_{SENSE}	I_{OUT1} or $I_{OUT2}=5A$; $V_{SENSE}=4V$; other channels open; $T_j=-40^\circ C$ $T_j=25^\circ C...150^\circ C$	4200 4400	4900 4900	6000 5750	
dK_2/K_2	Current Sense Ratio Drift	I_{OUT1} or $I_{OUT2}=5A$; $V_{SENSE}=4V$; other channels open; $T_j=-40^\circ C...150^\circ C$	-6		+6	%
K_3	I_{OUT}/I_{SENSE}	I_{OUT1} or $I_{OUT2}=15A$; $V_{SENSE}=4V$; other channels open; $T_j=-40^\circ C$ $T_j=25^\circ C...150^\circ C$	4200 4400	4900 4900	5500 5250	
dK_3/K_3	Current Sense Ratio Drift	I_{OUT1} or $I_{OUT2}=15A$; $V_{SENSE}=4V$; other channels open; $T_j=-40^\circ C...150^\circ C$	-6		+6	%
$V_{SENSE1,2}$	Max analog sense output voltage	$V_{CC}=5.5V$; $I_{OUT1,2}=2.5A$; $R_{SENSE}=10k\Omega$ $V_{CC}>8V$, $I_{OUT1,2}=5A$; $R_{SENSE}=10k\Omega$	2 4			V V
V_{SENSEH}	Analog sense output voltage in overtemperature condition	$V_{CC}=13V$; $R_{SENSE}=3.9k\Omega$		5.5		V
$R_{VSENSEH}$	Analog Sense Output Impedance in Overtemperature Condition	$V_{CC}=13V$; $T_j>T_{TSD}$; All channels Open		400		Ω
t_{DSENSE}	Current sense delay response	to 90% I_{SENSE} (see note 3)			500	μs

Note: 3. Current sense signal delay after positive input slope.

Table 9. Switching ($V_{CC}=13V$)

Symbol	Parameter	Test Conditions	Min	Typ	Max	Unit
$t_{d(on)}$	Turn-on delay time	$R_L=2.6\Omega$ (see figure 6)		30		μs
$t_{d(off)}$	Turn-off delay time	$R_L=2.6\Omega$ (see figure 6)		30		μs
$(dV_{OUT}/dt)_{on}$	Turn-on voltage slope	$R_L=2.6\Omega$ (see figure 6)		See relative diagram		$V/\mu s$
$(dV_{OUT}/dt)_{off}$	Turn-off voltage slope	$R_L=2.6\Omega$ (see figure 6)		See relative diagram		$V/\mu s$

Table 10. Logic Input (Channel 1, 2)

Symbol	Parameter	Test Conditions	Min	Typ	Max	Unit
V_{IL}	Input low level voltage				1.25	V
I_{IL}	Low level input current	$V_{IN}=1.25V$	1			μA
V_{IH}	Input high level voltage		3.25			V
I_{IH}	High level input current	$V_{IN}=3.25V$			10	μA
$V_{I(hyst)}$	Input hysteresis voltage		0.5			V
V_{ICL}	Input clamp voltage	$I_{IN}=1mA$ $I_{IN}=-1mA$	6	6.8 -0.7	8	V V

Figure 5. I_{OUT}/I_{SENSE} versus I_{OUT}

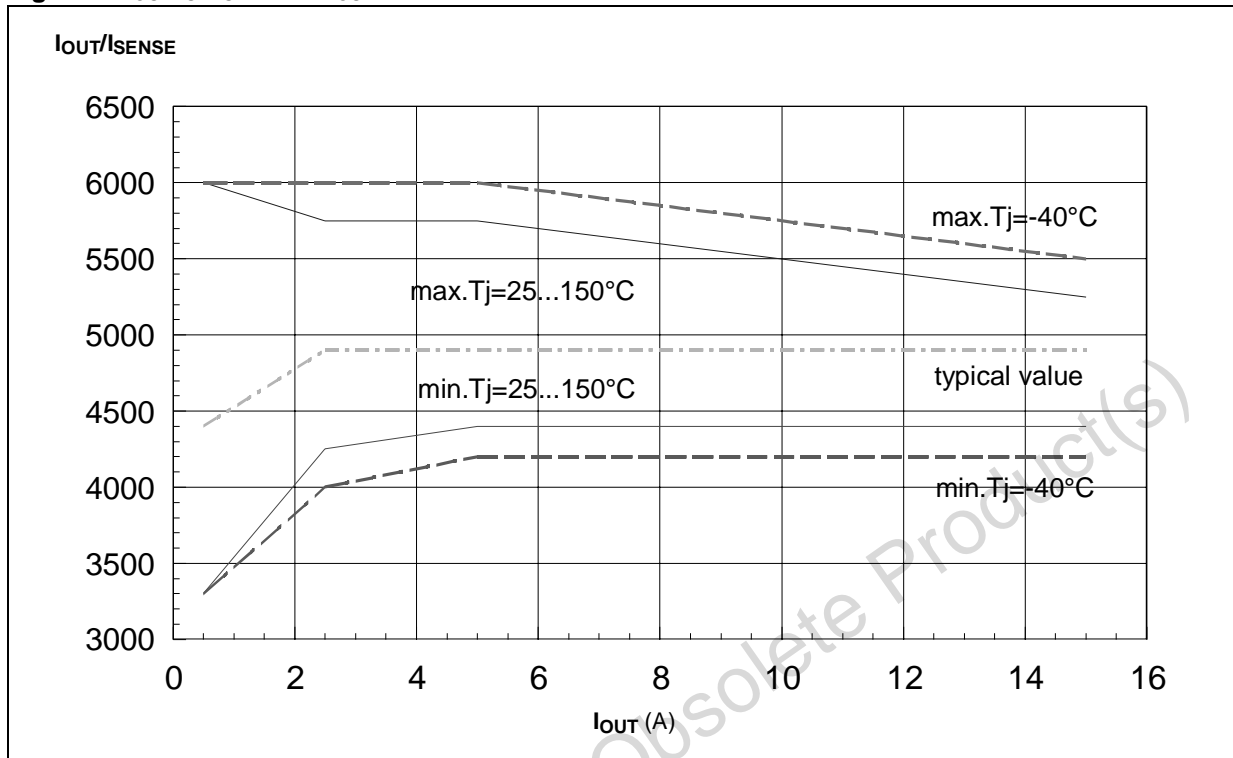

Table 11. Truth Table (per channel)

CONDITIONS	INPUT	OUTPUT	SENSE
Normal operation	L	L	0
	H	H	Nominal
Overtemperature	L	L	0
	H	L	V _{SENSEH}
Undervoltage	L	L	0
	H	L	0
Overvoltage	L	L	0
	H	L	0
Short circuit to GND	L	L	0
	H	L	(T _j <T _{TSD}) 0
	H	L	(T _j >T _{TSD}) V _{SENSEH}
Short circuit to V _{CC}	L	H	0
	H	H	< Nominal
Negative output voltage clamp	L	L	0

Figure 6. Switching Characteristics (Resistive load $R_L=2.6\Omega$)

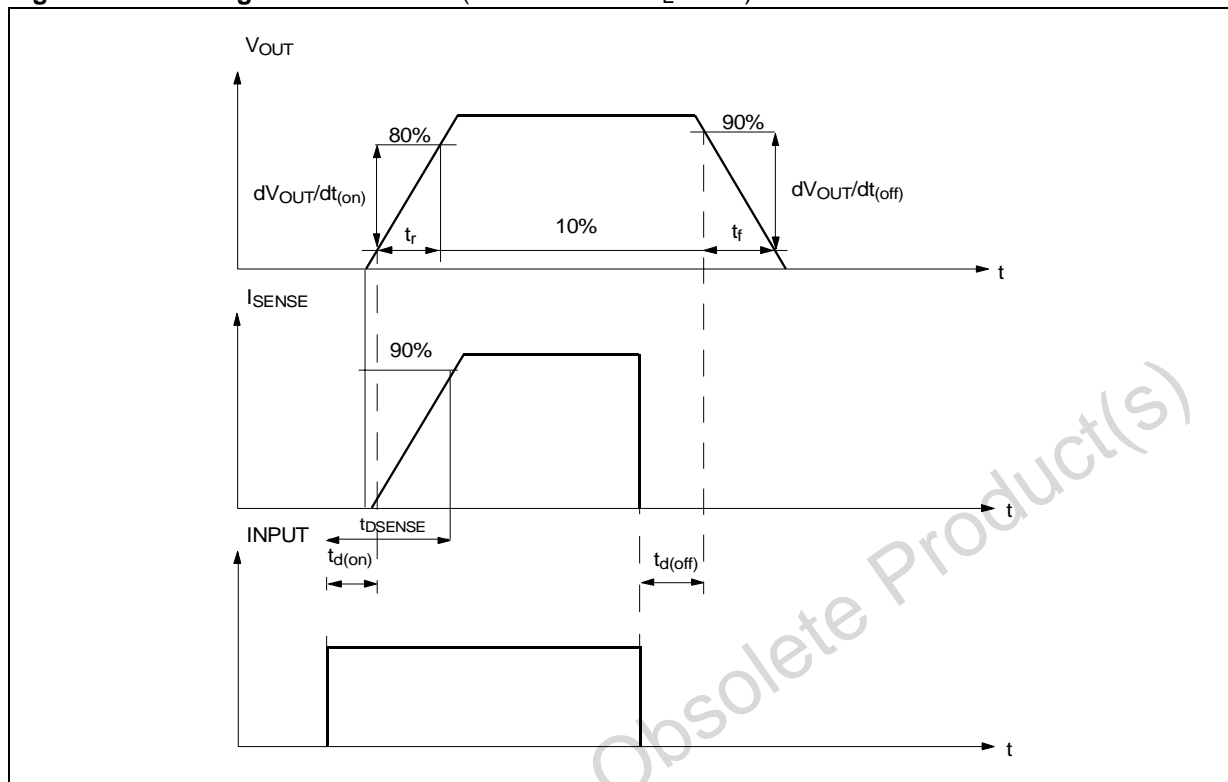

Table 12. Electrical Transient Requirements On V_{CC} Pin

ISO T/R 7637/1 Test Pulse	TEST LEVELS				Delays and Impedance
	I	II	III	IV	
1	-25 V	-50 V	-75 V	-100 V	2 ms 10 Ω
2	+25 V	+50 V	+75 V	+100 V	0.2 ms 10 Ω
3a	-25 V	-50 V	-100 V	-150 V	0.1 μ s 50 Ω
3b	+25 V	+50 V	+75 V	+100 V	0.1 μ s 50 Ω
4	-4 V	-5 V	-6 V	-7 V	100 ms, 0.01 Ω
5	+26.5 V	+46.5 V	+66.5 V	+86.5 V	400 ms, 2 Ω

ISO T/R 7637/1 Test Pulse	TEST LEVELS RESULTS			
	I	II	III	IV
1	C	C	C	C
2	C	C	C	C
3a	C	C	C	C
3b	C	C	C	C
4	C	C	C	C
5	C	E	E	E

CLASS	CONTENTS
C	All functions of the device are performed as designed after exposure to disturbance.
E	One or more functions of the device is not performed as designed after exposure to disturbance and cannot be returned to proper operation without replacing the device.

Figure 7. Waveforms

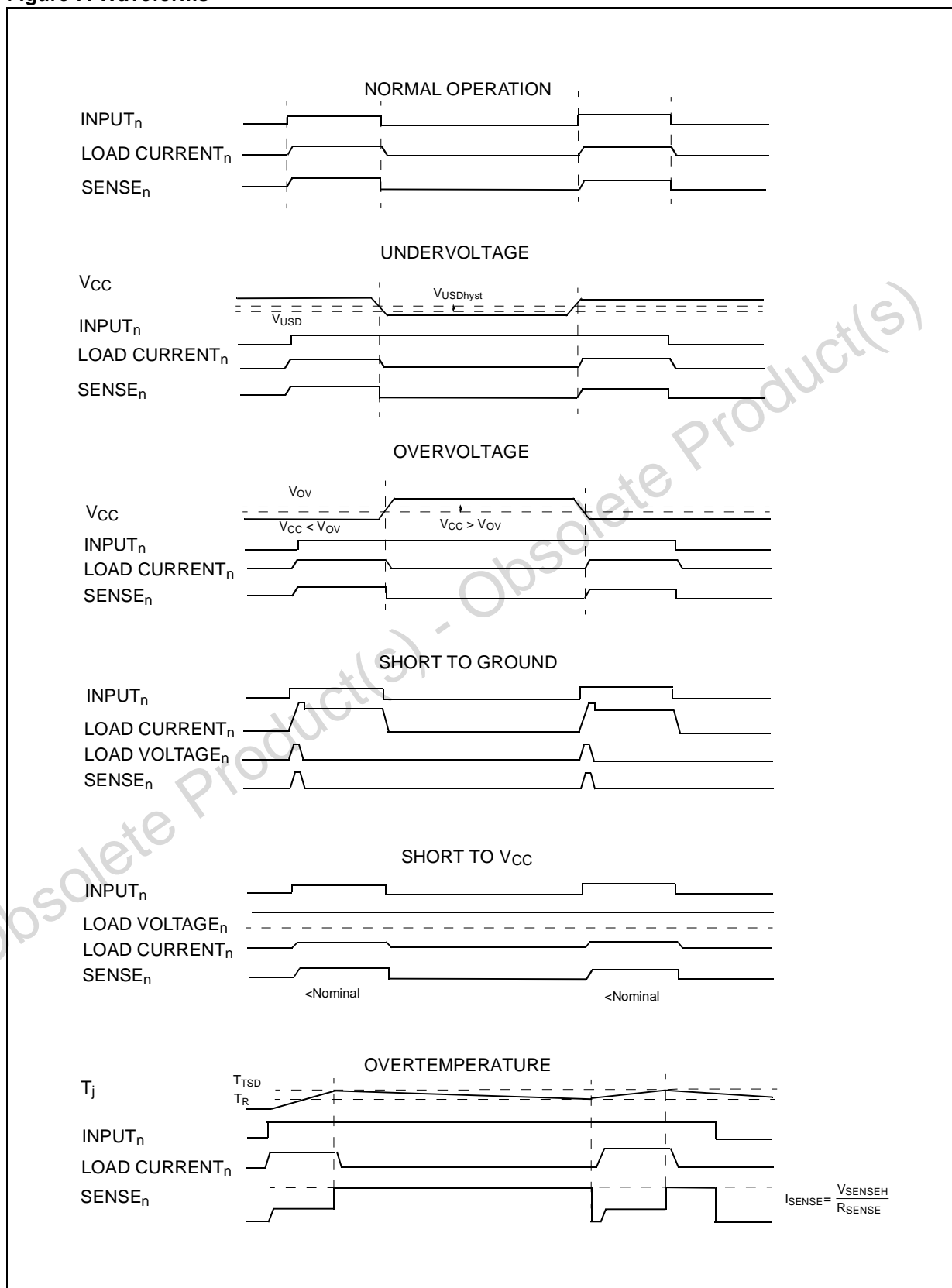
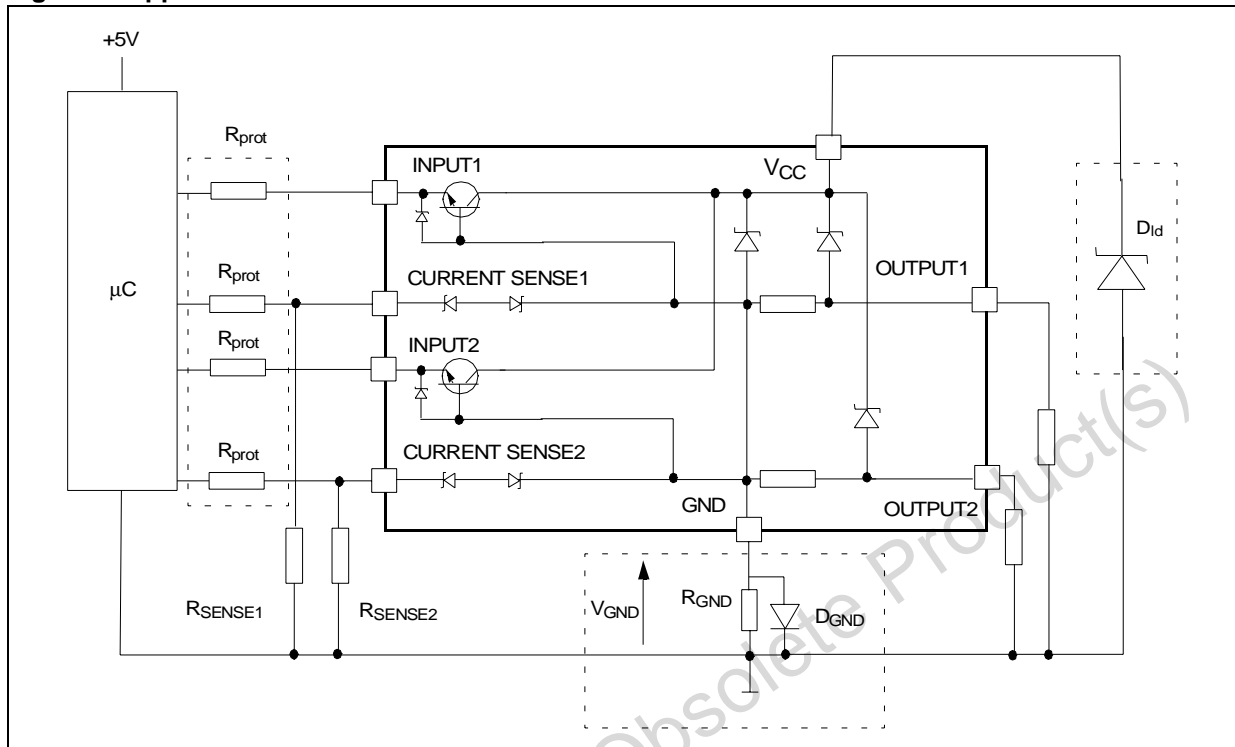

Figure 8. Application Schematic



GND PROTECTION NETWORK AGAINST REVERSE BATTERY

Solution 1: Resistor in the ground line (R_{GND} only). This can be used with any type of load.

The following is an indication on how to dimension the R_{GND} resistor.

- 1) $R_{GND} \leq 600\text{mV} / I_{S(\text{on})\text{max}}$.
- 2) $R_{GND} \geq (-V_{CC}) / (-I_{GND})$

where $-I_{GND}$ is the DC reverse ground pin current and can be found in the absolute maximum rating section of the device's datasheet.

Power Dissipation in R_{GND} (when $V_{CC} < 0$: during reverse battery situations) is:

$$P_D = (-V_{CC})^2 / R_{GND}$$

This resistor can be shared amongst several different HSD. Please note that the value of this resistor should be calculated with formula (1) where $I_{S(\text{on})\text{max}}$ becomes the sum of the maximum on-state currents of the different devices.

Please note that if the microprocessor ground is not common with the device ground then the R_{GND} will produce a shift ($I_{S(\text{on})\text{max}} * R_{GND}$) in the input thresholds and the status output values. This shift will vary depending on how many devices are ON in the case of several high side drivers sharing the same R_{GND} .

If the calculated power dissipation leads to a large resistor or several devices have to share the same resistor then the ST suggests to utilize Solution 2 (see below).

Solution 2: A diode (D_{GND}) in the ground line.

A resistor ($R_{GND} = 1\text{k}\Omega$) should be inserted in parallel to D_{GND} if the device will be driving an inductive load.

This small signal diode can be safely shared amongst several different HSDs.

Also in this case, the presence of the ground network will produce a shift ($\approx 600\text{mV}$) in the input thresholds and the status output values if the microprocessor ground is not common with the device ground. This shift will not vary if more than one HSD shares the same diode/resistor network.

Series resistor in INPUT and STATUS lines are also required to prevent that, during battery voltage transient, the current exceeds the Absolute Maximum Rating.

Safest configuration for unused INPUT and STATUS pin is to leave them unconnected.

LOAD DUMP PROTECTION

D_{id} is necessary (Voltage Transient Suppressor) if the load dump peak voltage exceeds V_{CC} max DC rating. The same applies if the device will be subject to transients on the V_{CC} line that are greater than the ones shown in the ISO T/R 7637/1 table.

µC I/Os PROTECTION:

If a ground protection network is used and negative transient are present on the V_{CC} line, the control pins will be pulled negative. ST suggests to insert a resistor (R_{prot}) in line to prevent the μC I/Os pins to latch-up.

The value of these resistors is a compromise between the leakage current of μC and the current required by the HSD I/Os (Input levels compatibility) with the latch-up limit of μC I/Os.

$$-V_{CC\text{peak}} / I_{\text{latchup}} \leq R_{\text{prot}} \leq (V_{OH\mu\text{C}} - V_{IH} - V_{GND}) / I_{IH\text{max}}$$

Calculation example:

For $V_{CC\text{peak}} = -100\text{V}$ and $I_{\text{latchup}} \geq 20\text{mA}$; $V_{OH\mu\text{C}} \geq 4.5\text{V}$
 $5\text{k}\Omega \leq R_{\text{prot}} \leq 65\text{k}\Omega$.

Recommended R_{prot} value is $10\text{k}\Omega$.

Figure 9. Off State Output Current

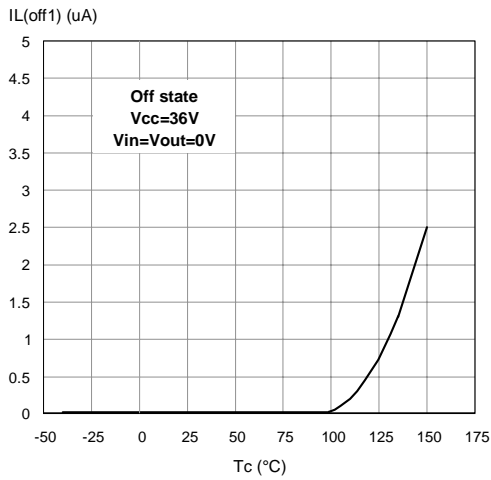

Figure 10. High Level Input Current

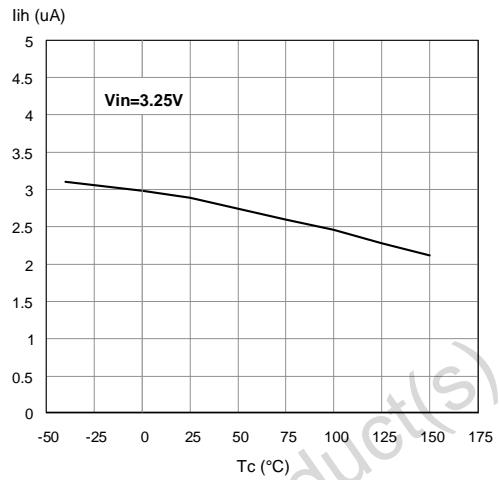

Figure 11. Input Clamp Voltage

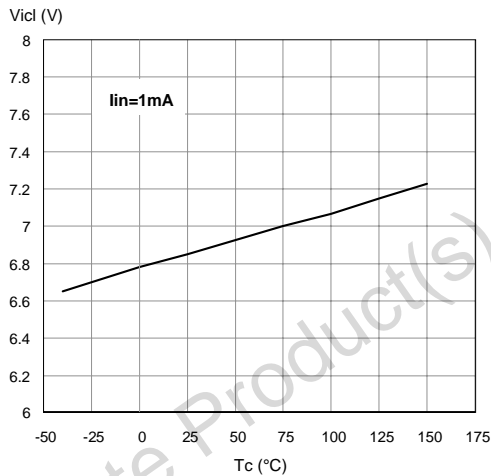

Figure 13. Input High Level

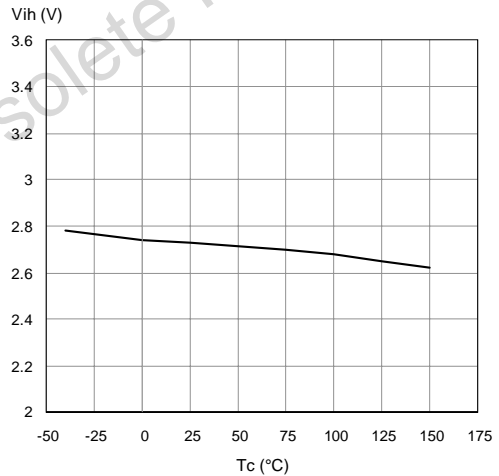

Figure 12. Input Low Level

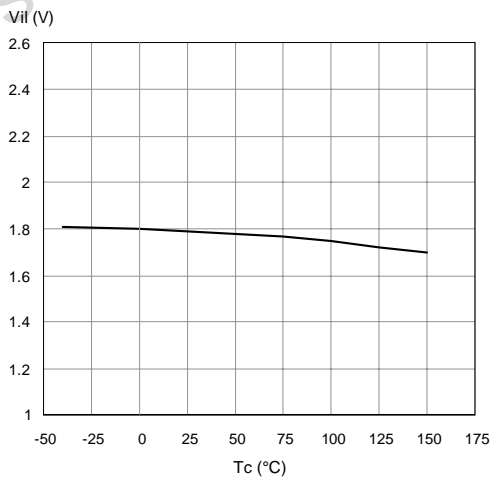

Figure 14. Input Hysteresis Voltage

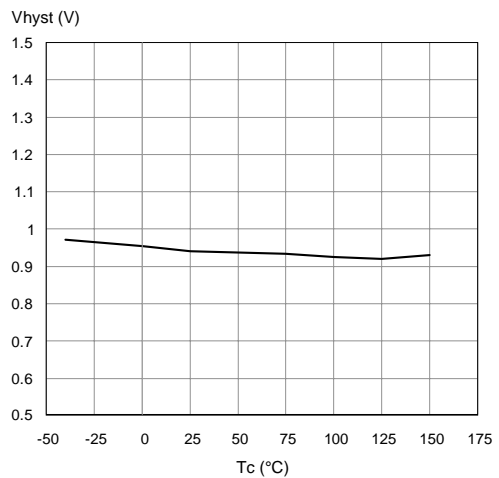

Figure 15. Overvoltage Shutdown

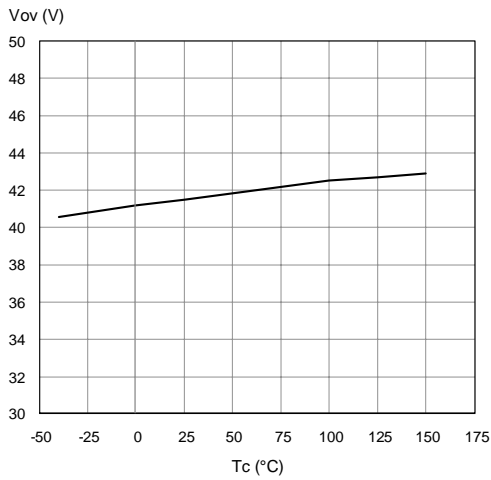

Figure 18. I_{LIM} Vs T_{case}

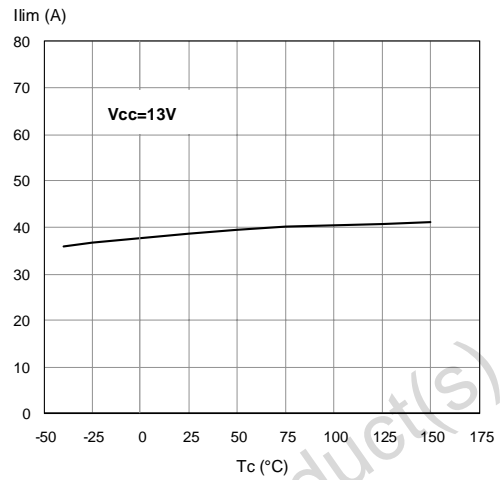

Figure 16. Turn-on Voltage Slope

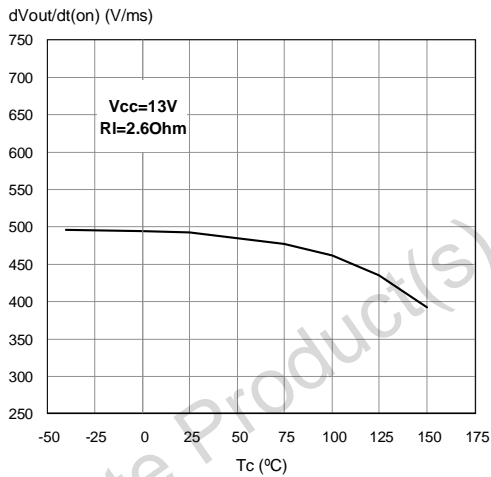

Figure 19. Turn-off Voltage Slope

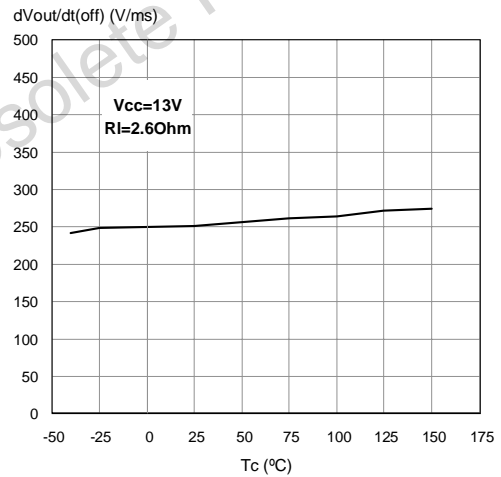

Figure 17. On State Resistance Vs T_{case}

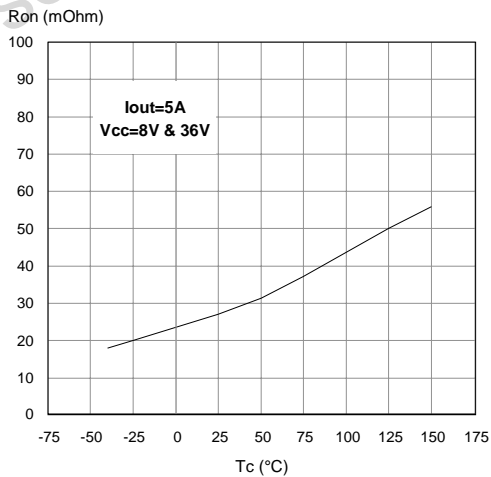

Figure 20. On State Resistance Vs V_{CC}

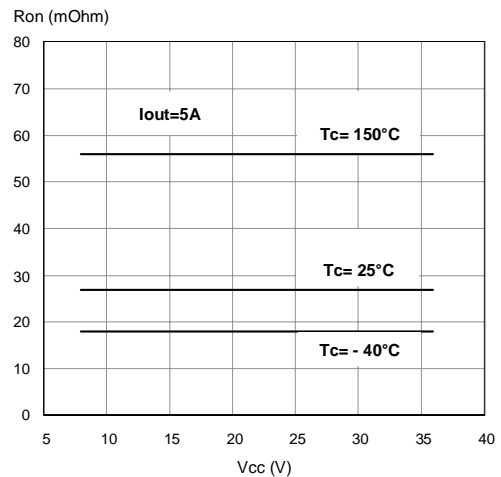
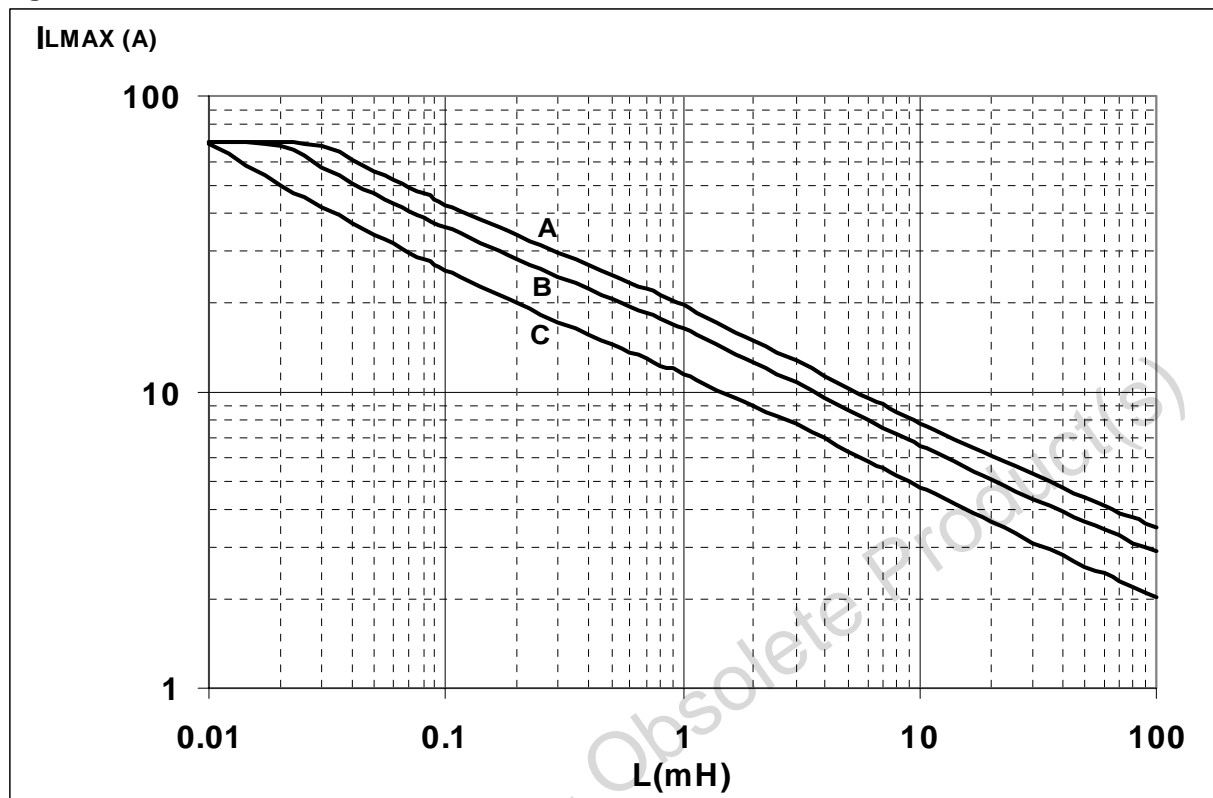

Figure 21. SO-16L Maximum turn off current versus load inductance



- A = Single Pulse at $T_{jstart}=150^{\circ}C$
- B= Repetitive pulse at $T_{jstart}=100^{\circ}C$
- C= Repetitive Pulse at $T_{jstart}=125^{\circ}C$

Values are generated with $R_L=0\Omega$

In case of repetitive pulses, T_{jstart} (at beginning of each demagnetization) of every pulse must not exceed the temperature specified above for curves B and C.

Conditions:

$V_{CC}=13.5V$

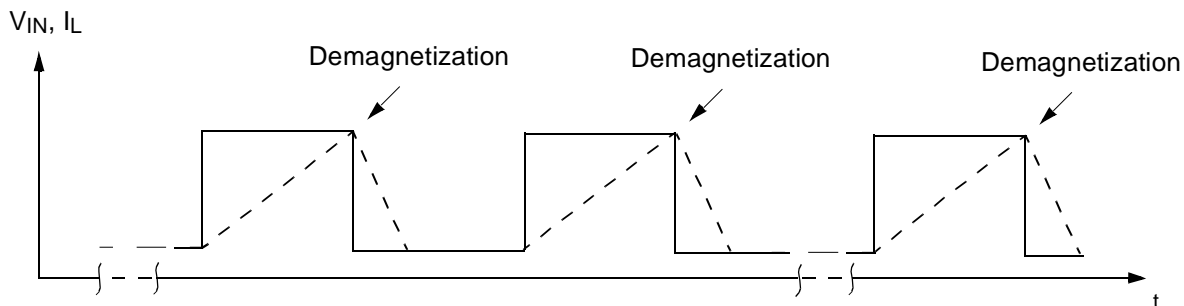

SO-16L Thermal Data

Figure 22. SO-16L PC Board

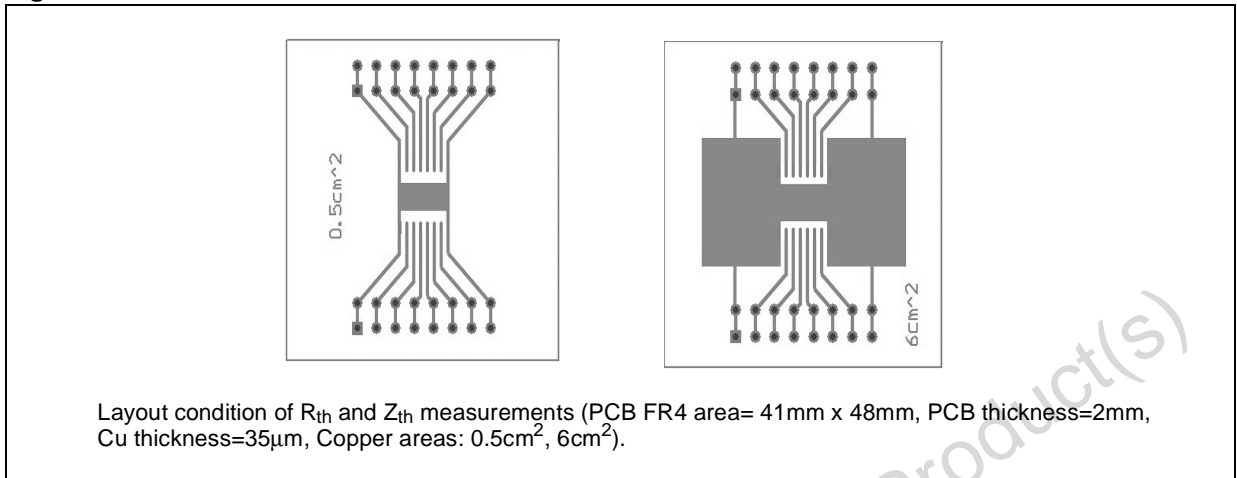

Figure 23. $R_{thj-amb}$ Vs PCB copper area in open box free air condition

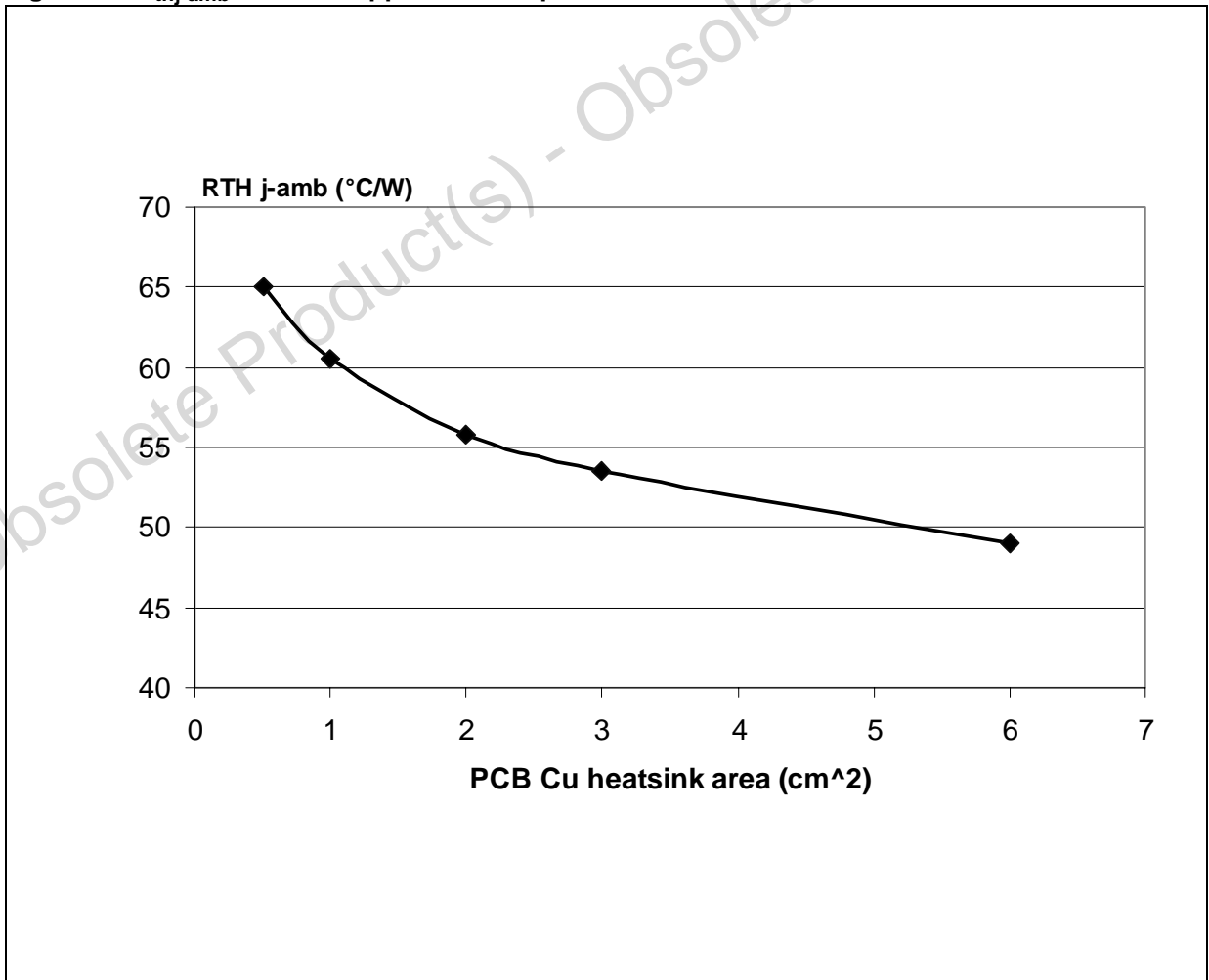

Figure 24. SO-16L Thermal Impedance Junction Ambient Single Pulse

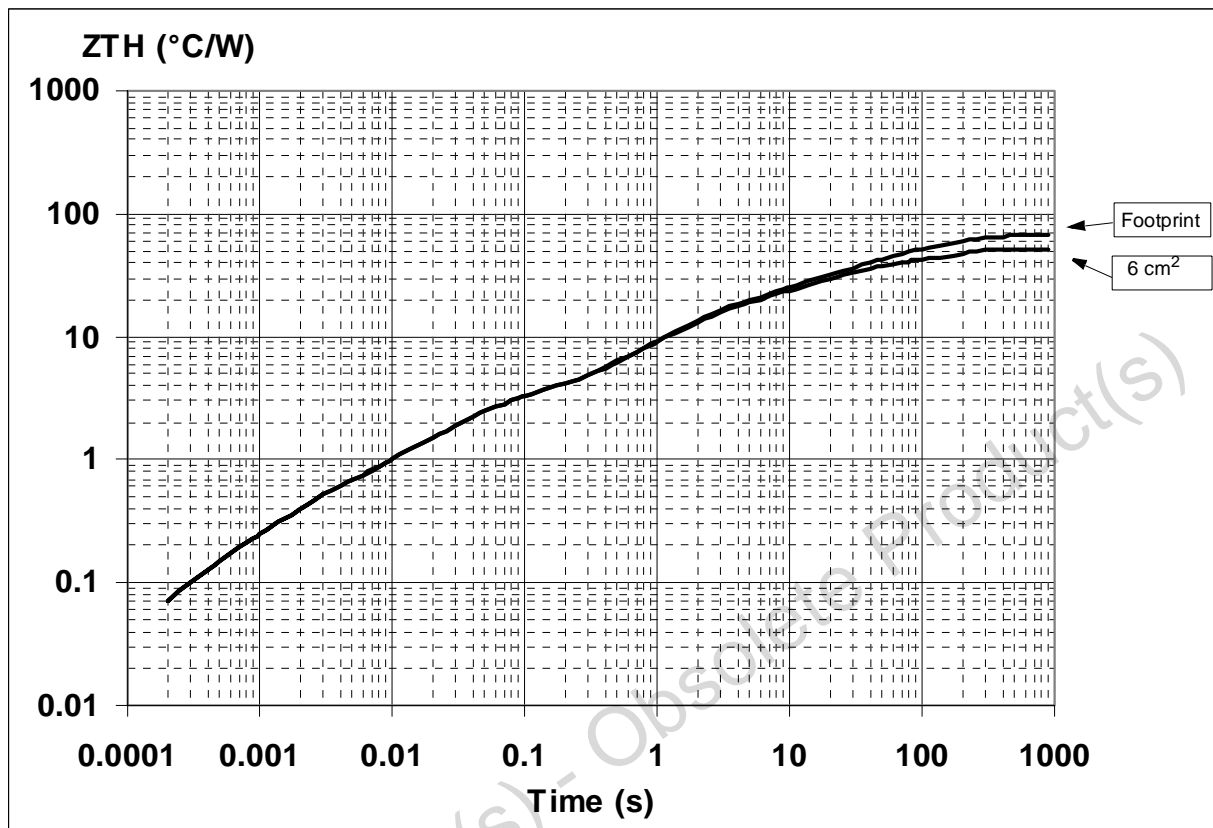
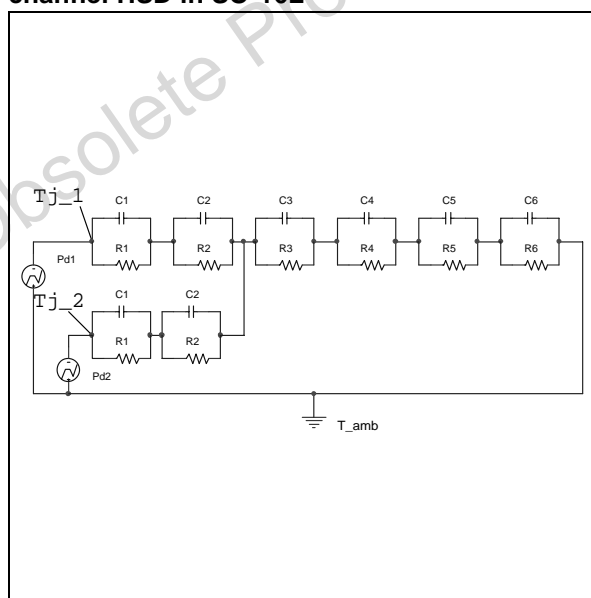

Figure 25. Thermal fitting model of a double channel HSD in SO-16L



Pulse calculation formula

$$Z_{TH\delta} = R_{TH} \cdot \delta + Z_{THtp}(1 - \delta)$$

where $\delta = t_p/T$

Table 13. Thermal Parameter

Area/island (cm ²)	Footprint	6
R1 (°C/W)	0.05	
R2 (°C/W)	0.3	
R3 (°C/W)	2.2	
R4 (°C/W)	12	
R5 (°C/W)	15	
R6 (°C/W)	37	22
C1 (W.s/°C)	0.001	
C2 (W.s/°C)	5.00E-03	
C3 (W.s/°C)	0.02	
C4 (W.s/°C)	0.3	
C5 (W.s/°C)	1	
C6 (W.s/°C)	3	5



PACKAGE MECHANICAL

Table 14. SO-16L Mechanical Data

Symbol	millimeters		
	Min	Typ	Max
A			2.65
a1	0.1		0.2
a2			2.45
b	0.35		0.49
b1	0.23		0.32
C		0.5	
c1		45° (typ.)	
D	10.1		10.5
E	10.0		10.65
e		1.27	
e3		8.89	
F	7.4		7.6
L	0.5		1.27
M			0.75
S		8° (max.)	

Figure 26. SO-16L Package Dimensions

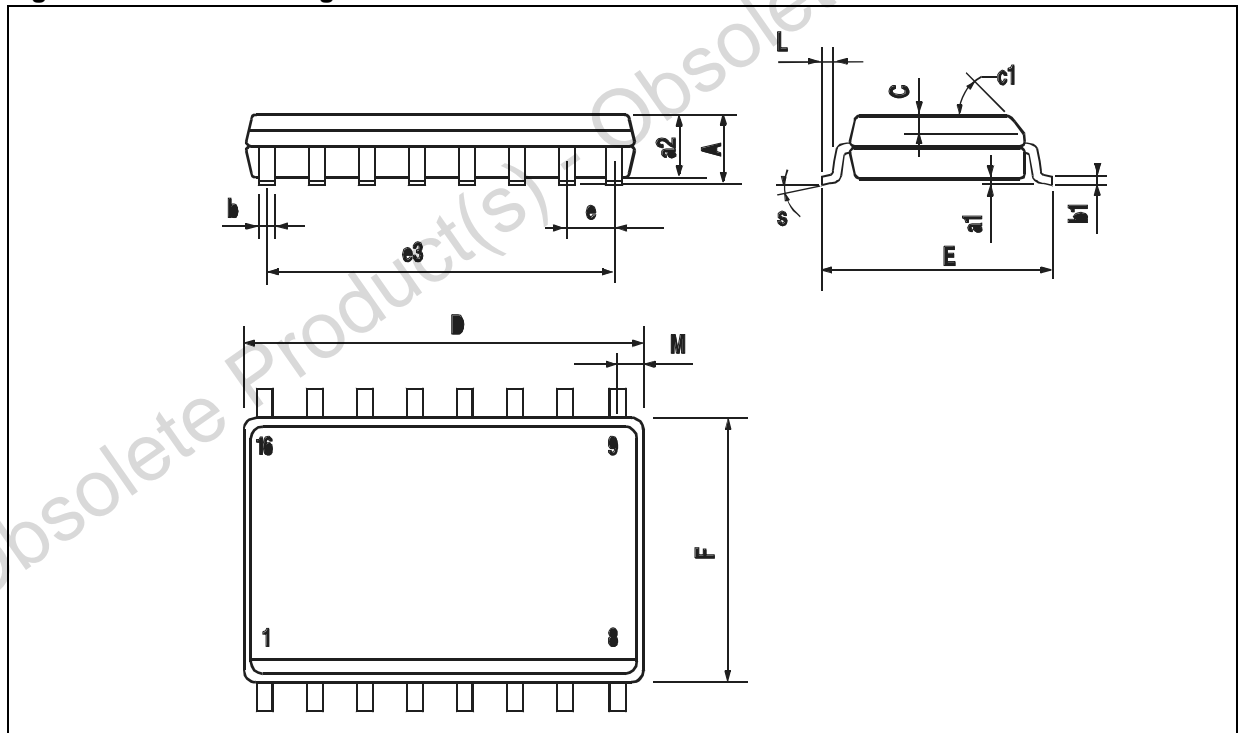

Figure 27. SO-16L Tube Shipment (No Suffix)

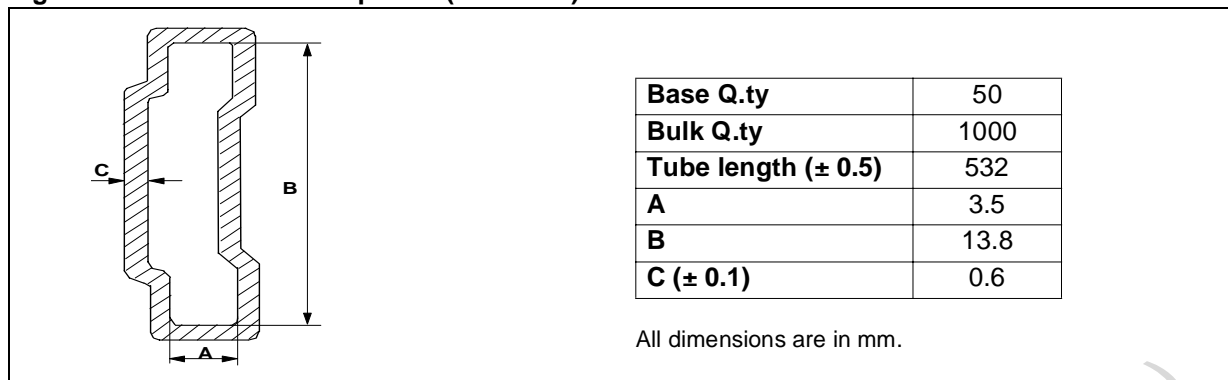
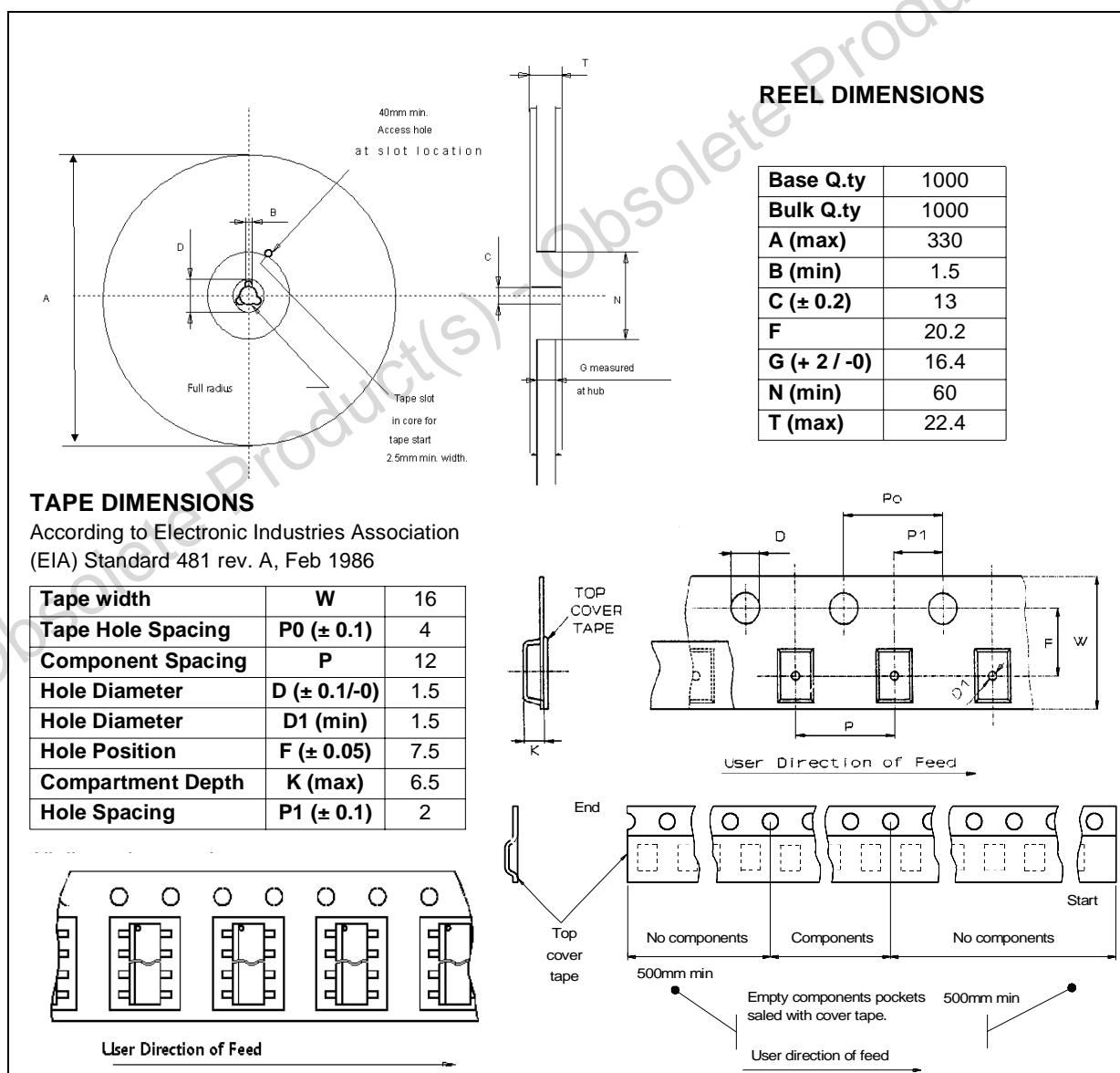

Figure 28. Tape And Reel Shipment (Suffix "TR")



REVISION HISTORY

Date	Revision	Description of Changes
Oct. 2004	1	- First Issue.

Obsolete Product(s) - Obsolete Product(s)

Obsolete Product(s) - Obsolete Product(s)

Information furnished is believed to be accurate and reliable. However, STMicroelectronics assumes no responsibility for the consequences of use of such information nor for any infringement of patents or other rights of third parties which may result from its use. No license is granted by implication or otherwise under any patent or patent rights of STMicroelectronics. Specifications mentioned in this publication are subject to change without notice. This publication supersedes and replaces all information previously supplied. STMicroelectronics products are not authorized for use as critical components in life support devices or systems without express written approval of STMicroelectronics.

The ST logo is a registered trademark of STMicroelectronics.
All other names are the property of their respective owners

© 2004 STMicroelectronics - All rights reserved

STMicroelectronics group of companies
Australia - Belgium - Brazil - Canada - China - Czech Republic - Finland - France - Germany - Hong Kong - India - Israel - Italy - Japan -
Malaysia - Malta - Morocco - Singapore - Spain - Sweden - Switzerland - United Kingdom - United States of America
www.st.com