

300 mA very low dropout linear regulator IC



DFN4 1x1

Features

- Input voltage from 1.5 to 5.5 V
- Ultra low dropout voltage (135 mV typ. at 300 mA load)
- Very low quiescent current (28 μ A typ. at no load, 0.03 μ A typ. in off mode)
- Internal current fold-back
- Output voltage tolerance: $\pm 1\%$ @ 25 $^{\circ}$ C
- 300 mA guaranteed output current
- High PSRR: 75 dB@1 kHz
- Wide range of output voltages available on request: from 0.8 V up to 5.0 V in 50 mV step
- Logic-controlled electronic shutdown
- Internal soft-start
- Optional output voltage discharge feature
- Compatible with ceramic capacitor $C_{OUT} = 0.47\ \mu$ F
- Thermal protection
- Available in DFN4 1x1
- Operating temperature range: -40 $^{\circ}$ C to 125 $^{\circ}$ C

Description

The LD59030 high accuracy voltage regulator provides 300 mA of maximum current from an input voltage ranging from 1.5 V to 5.5 V, with a typical dropout voltage of 135 mV at $V_{OUT} = 3.3$ V.

It is available in DFN4 1x1 package, allowing the maximum space saving.

The device works with a ceramic capacitor on the output. The ultra-low drop voltage, low quiescent current and low noise features, together with the internal soft-start circuit and output current fold-back protection, make the LD59030 suitable for low power battery-operated applications.

An enable logic control function puts the LD59030 in shutdown mode allowing a total current consumption lower than 0.03 μ A.

Maturity status link

[LD59030](#)

1 Diagram

Figure 1. Block diagram

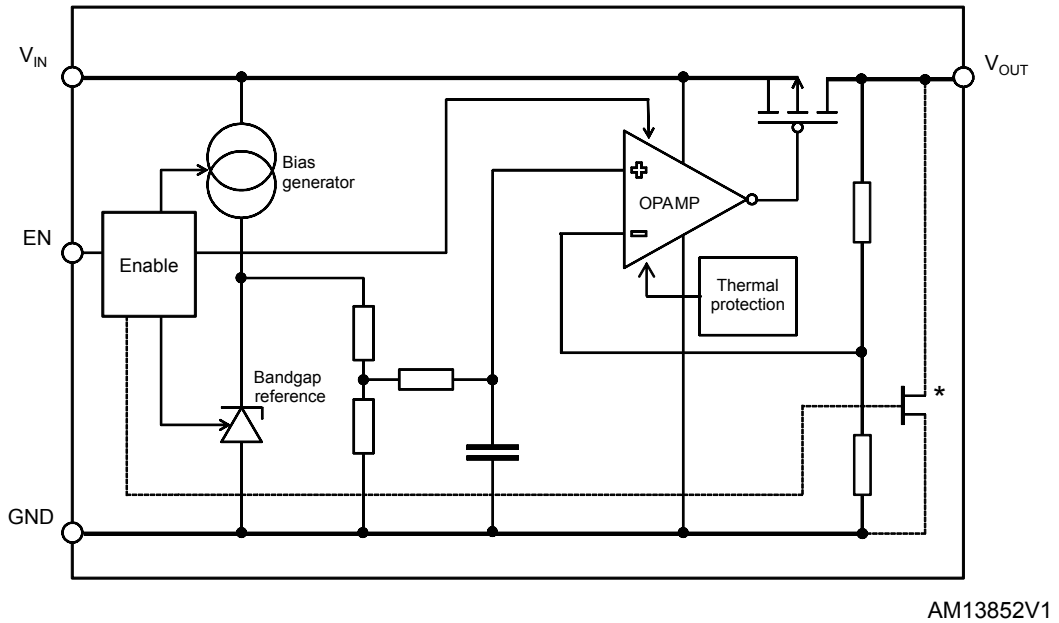

Note: The output discharge MOSFET is optional.

2 Pin configuration

Figure 2. Pin connection (top view)

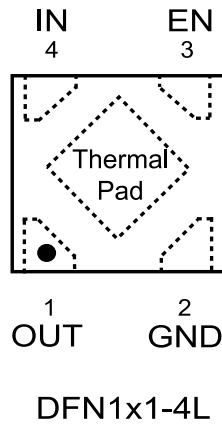
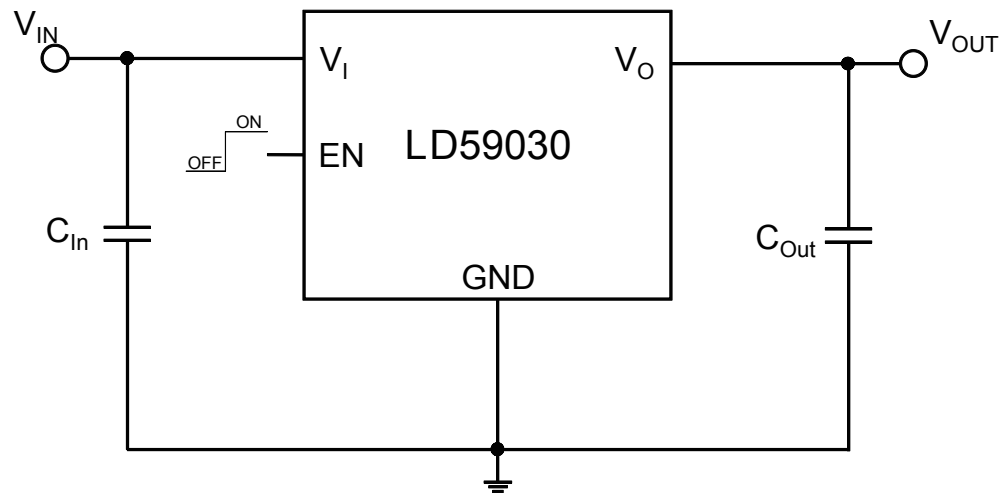

Table 1. Pin description

| Pin n° DFN4 1x1 | Symbol | Function |
|-----------------|--------|---|
| 1 | OUT | Output voltage |
| 2 | GND | Common ground |
| 3 | EN | Enable pin logic input: Low = shutdown, High = active |
| 4 | IN | Input voltage |
| Thermal pad | - | Connect to GND |

3 Typical application

Figure 3. Typical application circuit



4 Maximum ratings

Table 2. Absolute maximum ratings

| Symbol | Parameter | Value | Unit |
|-----------|--------------------------------------|-------------------------|------|
| V_{IN} | Input voltage | - 0.3 to 7 | V |
| V_{OUT} | Output voltage | - 0.3 to $V_{IN} + 0.3$ | V |
| V_{EN} | Enable input voltage | - 0.3 to 7 | V |
| I_{OUT} | Output current | Internally limited | mA |
| P_D | Power dissipation | Internally limited | mW |
| T_{STG} | Storage temperature range | - 40 to 150 | °C |
| T_{OP} | Operating junction temperature range | - 40 to 125 | °C |

Note: *Absolute maximum ratings are those values beyond which damage to the device may occur. Functional operation under these conditions is not implied. All values are referred to GND.*

Table 3. Thermal data

| Symbol | Parameter | Value | Unit |
|------------|-------------------------------------|-------|------|
| R_{thJA} | Thermal resistance junction-ambient | 140 | °C/W |

Table 4. ESD Performance

| Symbol | Parameter | Test conditions | Value | Unit |
|--------|------------------------|-----------------|-------|------|
| ESD | ESD Protection voltage | HBM | 2 | kV |
| | | CDM | 500 | V |

Note: *Thermal Pad, which is tied to internal substrate for thermal dissipation purpose, is able to sustain 1000 V of HBM voltage which allows safe manufacturing with a standard ESD control process as per JEDEC document JEP155.*

5 Electrical characteristics

$T_J = 25\text{ }^\circ\text{C}$, $V_{IN} = V_{OUT(NOM)} + 1\text{ V}$, $C_{IN} = C_{OUT} = 1\text{ }\mu\text{F}$, $I_{OUT} = 1\text{ mA}$, $V_{EN} = V_{IN}$, unless otherwise specified.

Table 5. Electrical characteristics

| Symbol | Parameter | Test conditions | Min. | Typ. | Max. | Unit |
|-------------------------|---------------------------------------|--|------|--------|-------|---------------------|
| V_{IN} | Operating input voltage | | 1.5 | | 5.5 | V |
| V_{OUT} | V_{OUT} accuracy | $I_{OUT} = 1\text{ mA}$, $T_J = 25\text{ }^\circ\text{C}$ | -1 | | 1 | % |
| | | $I_{OUT} = 1\text{ mA}$, $-40\text{ }^\circ\text{C} < T_J < 85\text{ }^\circ\text{C}$ | -2 | | 2 | % |
| ΔV_{OUT} | Static line regulation ⁽¹⁾ | $V_{OUT(NOM)} + 1\text{ V} \leq V_{IN} \leq 5.5\text{ V}$, $I_{OUT} = 10\text{ mA}$ | | 0.015 | | %V |
| | | $-40\text{ }^\circ\text{C} < T_J < 85\text{ }^\circ\text{C}$ | | | 0.05 | |
| ΔV_{OUT} | Static load regulation | $I_{OUT} = 0\text{ mA to } 300\text{ mA}$ | | -20 | | mV |
| | | $I_{OUT} = 0\text{ mA to } 300\text{ mA}$ $-40\text{ }^\circ\text{C} < T_J < 85\text{ }^\circ\text{C}$ | | -0.004 | -0.01 | %/mA |
| V_{DROP} | Dropout voltage | $I_{OUT} = 30\text{ mA}$, $V_{OUT} = 2.8\text{ V}$ | | 20 | | mV |
| | | $I_{OUT} = 300\text{ mA}$, $V_{OUT} = 2.8\text{ V}$ $-40\text{ }^\circ\text{C} < T_J < 85\text{ }^\circ\text{C}$ | | 155 | 230 | |
| e_N | Output noise voltage | 10 Hz to 100 kHz, $I_{OUT} = 10\text{ mA}$, $V_{OUT} = 1.8\text{ V}$ | | 70 | | μV_{RMS} |
| SVR | Supply voltage rejection | $V_{IN} = V_{OUT(NOM)} + 1\text{ V} \pm V_{RIPPLE}$ $V_{RIPPLE} = 0.2\text{ V}$ Freq. = 1 kHz $I_{OUT} = 30\text{ mA}$ | | 75 | | dB |
| | | $V_{IN} = V_{OUT(NOM)} + 1\text{ V} \pm V_{RIPPLE}$ $V_{RIPPLE} = 0.2\text{ V}$ Freq. = 100 kHz $I_{OUT} = 30\text{ mA}$ | | 55 | | |
| I_Q | Quiescent current | $I_{OUT} = 0\text{ mA}$ | | 28 | 40 | μA |
| | | $I_{OUT} = 300\text{ mA}$ | | 305 | | |
| $I_{Standby}$ | Standby current | V_{IN} input current in OFF MODE: $V_{EN} = \text{GND}$ | | 0.03 | 1 | μA |
| I_{LIM} | Current limit | $V_{OUT} = 0.9 \times V_{OUT(NOM)}$ | | 500 | | mA |
| I_{SC} | Short circuit current | $V_{OUT} = 0$ (foldback protection) | 120 | 170 | | mA |
| R_{ON} | Output voltage discharge MOSFET | (LD59030DT version) $I_{OUT} = 1\text{ mA}$ | | 120 | | Ω |
| V_{EN} | Enable input logic low | $V_{IN} = 1.5\text{ V to } 5.5\text{ V}$ $-40\text{ }^\circ\text{C} < T_J < 85\text{ }^\circ\text{C}$ | | | 0.4 | V |
| | Enable input logic high | $V_{IN} = 1.5\text{ V to } 5.5\text{ V}$ $-40\text{ }^\circ\text{C} < T_J < 85\text{ }^\circ\text{C}$ | 1 | | | |
| I_{EN} | Enable pin input current | $V_{EN} = V_{IN}$ | | | 100 | nA |
| T_{ON} ⁽²⁾ | Turn on time | | | 145 | | μs |
| T_{SHDN} | Thermal shutdown | | | 160 | | $^\circ\text{C}$ |
| | Hysteresis | | | 20 | | |

| Symbol | Parameter | Test conditions | Min. | Typ. | Max. | Unit |
|------------------|------------------|--|------|------|------|------|
| C _{OUT} | Output capacitor | Capacitance (see Figure 15. Stability area vs. (C _{OUT} , ESR)) | 0.47 | | 22 | μF |

1. Not applicable for $V_{OUT(NOM)} > 4.5\text{ V}$
2. Turn-on time is time measured between the enable input just exceeding VEN high value and the output voltage just reaching 95 % of its nominal value

6 Application information

6.1 Soft-start function

The LD59030 has an internal soft start circuit. By increasing the startup time up to 145 μ s, without the need of any external soft start capacitor, this feature is able to keep the regulator inrush current at startup under control.

6.2 Output discharge function

The LD59030 integrates a MOSFET connected between V_{OUT} and GND. This transistor is activated when the EN pin goes to low logic level and has the function to quickly discharge the output capacitor when the device is disabled by the user.

The device is available with or without auto-discharge feature.

See [Section 9 Ordering information](#) for more details.

6.3 Dropout voltage

Table 6. Dropout voltage at $I_{OUT} = 300$ mA

| Output voltage [V] | Typical value [mV] $T_J = 25^\circ\text{C}$ | Max value [mV] $-40^\circ\text{C} < T_J < 85^\circ\text{C}$ |
|--------------------|---|---|
| 1.05 | 400 | 550 |
| 1.2 | 330 | 490 |
| 1.5 | 260 | 390 |
| 1.8 | 180 ⁽¹⁾ | 210 ⁽¹⁾ |
| 2.5 | 165 | 253 |
| 2.8 | 155 | 230 |
| 3.0 | 145 | 220 |
| 3.1 | 140 | 210 |
| 3.3 | 135 | 200 |

1. Measured value.

6.4 Input and output capacitors

The LD59030 requires external capacitors to assure the regulator control loop stability.

Any good quality ceramic capacitor can be used but, the X5R and the X7R are suggested since they guarantee a very stable combination of capacitance and ESR over the whole temperature range.

Locating the input/output capacitors as close as possible to the relative pins is recommended.

The LD59030 requires an input capacitor with a minimum value of 1 μ F. This capacitor must be located as close as possible to the input pin of the device and returned to a clean analog ground.

The control loop of the LD59030 is designed to work with an output ceramic capacitor.

This capacitor must meet the requirements of minimum capacitance and equivalent series resistance (ESR), as shown in [Figure 15. Stability area vs. \(\$C_{OUT}\$, ESR\)](#). To assure stability, the output capacitor must maintain its ESR and capacitance in the stable region, over the full operating temperature range.

In order to keep stability in all operating conditions (temperature, input voltage and load variations), a minimum output capacitor of 0.47 μ F is recommended.

The suggested combination of 1 μ F input and output capacitors offers a good compromise among the stability of the regulator, optimum transient response and total PCB area occupation.

7 Typical characteristics

($C_{IN} = C_{OUT} = 1 \mu\text{F}$, V_{EN} to V_{IN} , $T_J = 25^\circ\text{C}$ unless otherwise specified).

Figure 4. Output voltage vs. temperature ($V_{OUT} = 1.8 \text{ V}$; $I_{OUT} = 1 \text{ mA}$)

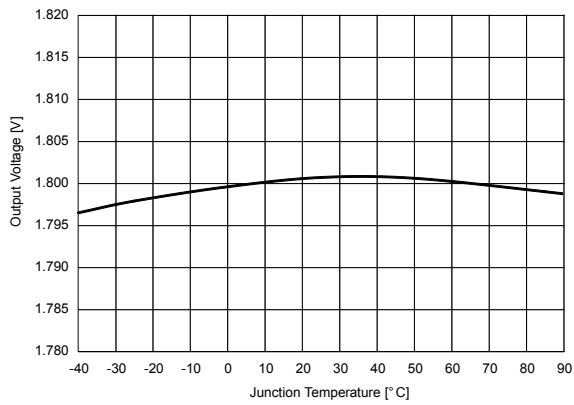

Figure 5. Output voltage vs. temperature ($V_{OUT} = 1.8 \text{ V}$; $I_{OUT} = 300 \text{ mA}$)

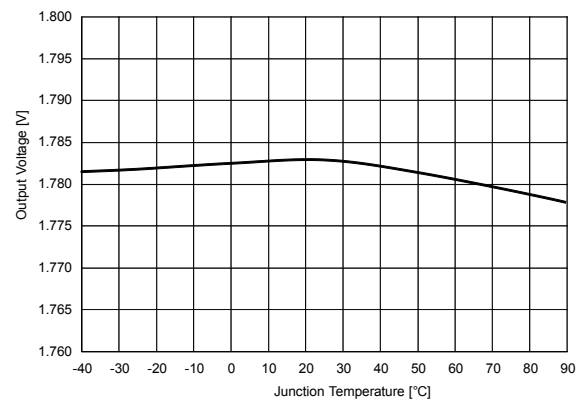

Figure 6. Line regulation vs. temperature ($V_{IN} = 2.8 \text{ V}$ to 5.5 V ; $V_{OUT} = 1.8 \text{ V}$; $I_{OUT} = 10 \text{ mA}$)

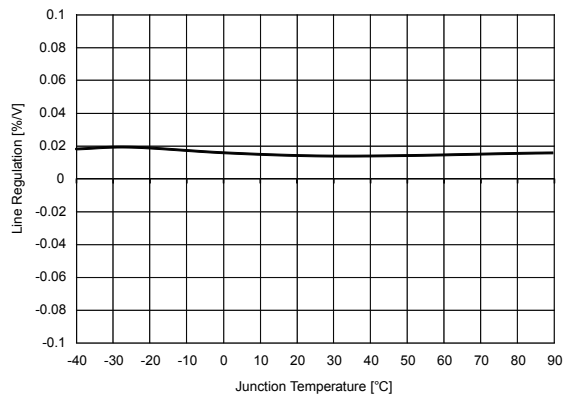

Figure 7. Load regulation vs. temperature ($V_{OUT} = 1.8 \text{ V}$; $I_{OUT} = 0$ to 300 mA)

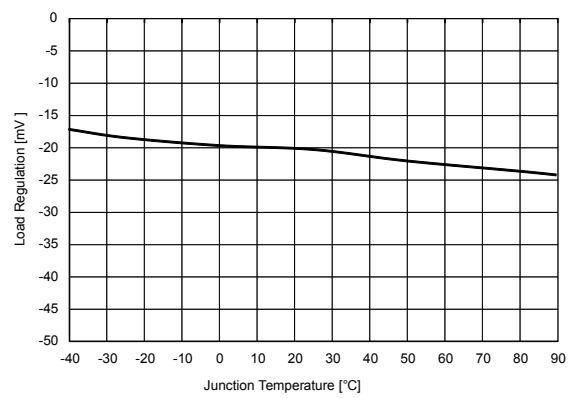

Figure 8. Quiescent current vs. temperature ($I_{OUT} = 0$ mA)

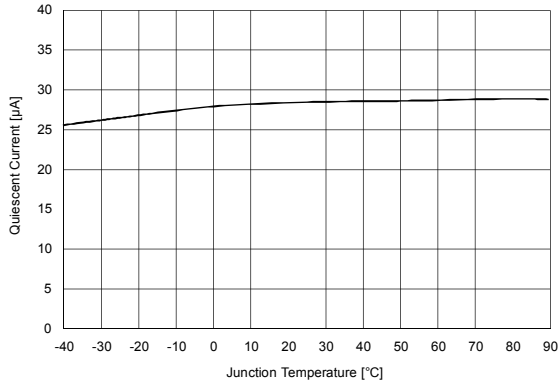

Figure 9. Quiescent current vs. temperature ($I_{OUT} = 300$ mA)

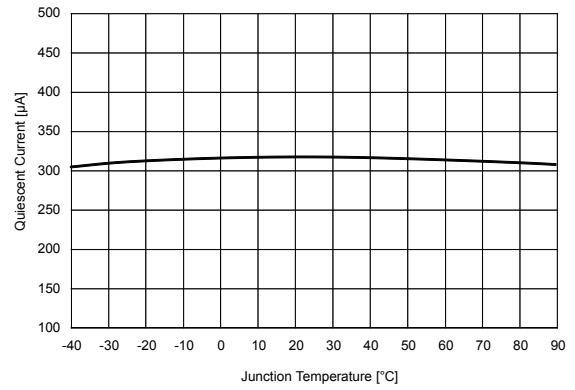

Figure 10. Shutdown current vs. temperature

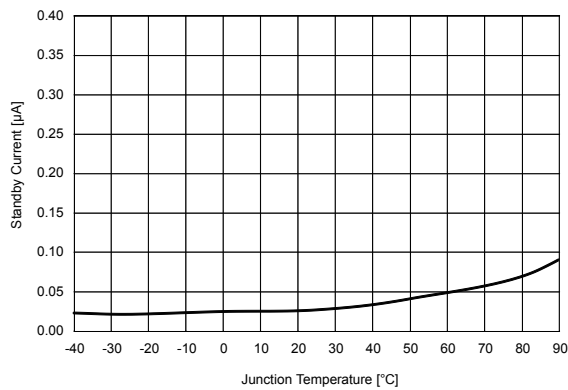

Figure 11. Dropout voltage vs. load current

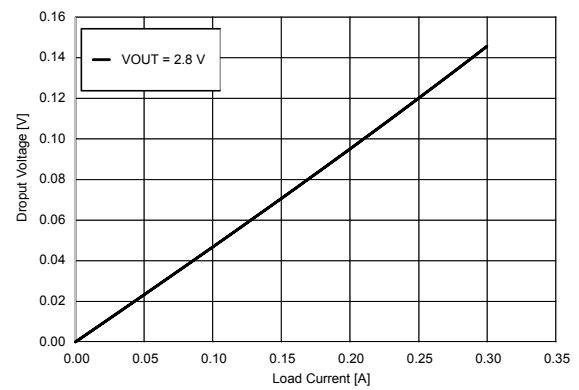

Figure 12. Quiescent current vs. output current ($V_{IN} = 2.8$ V; $V_{OUT} = 1.8$ V)

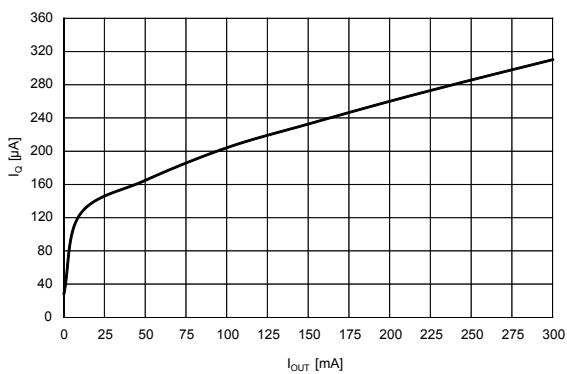

Figure 13. Dropout voltage vs. temperature ($V_{OUT} = 1.8$ V; $I_{OUT} = 300$ mA)

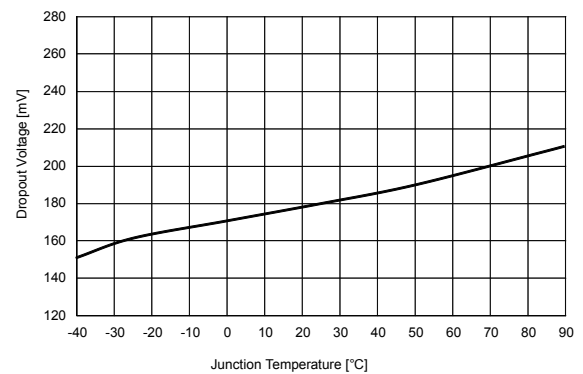

Figure 14. Supply voltage rejection vs. frequency

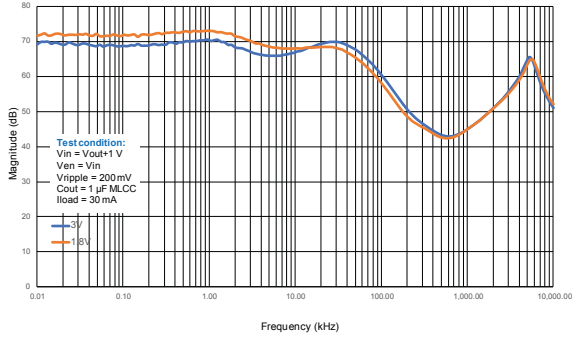

Figure 15. Stability area vs. (C_{OUT}, ESR)

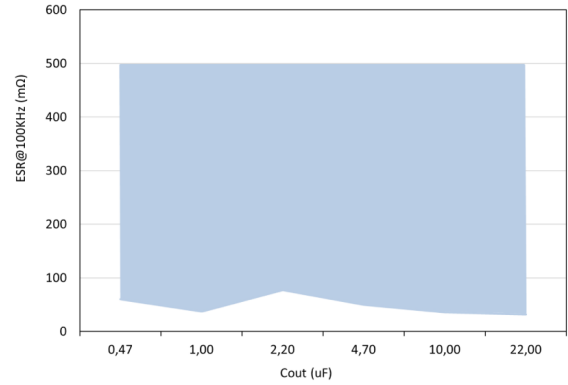

Figure 16. Output noise spectral density (V_{OUT} = 1.8 V)

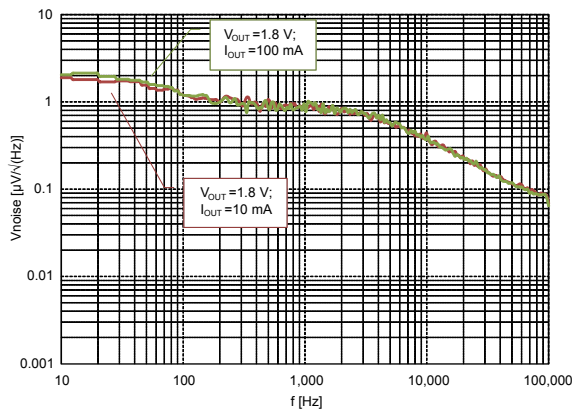

Figure 17. Output noise spectral density (V_{OUT} = 2.8 V)

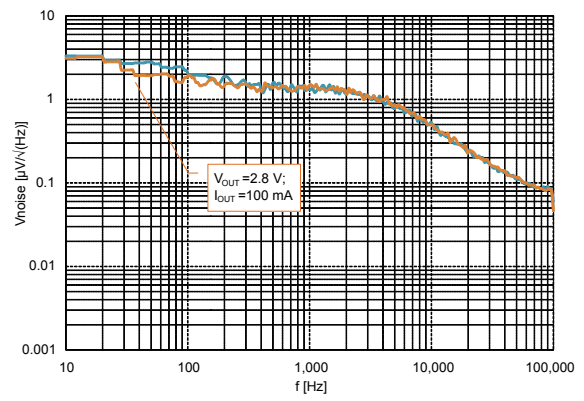

Figure 18. Turn-on Time (V_{OUT} = 1.8 V; I_{OUT} = 0 A, V_{IN} = 2.8 V, t_r = t_f = 1 µs)

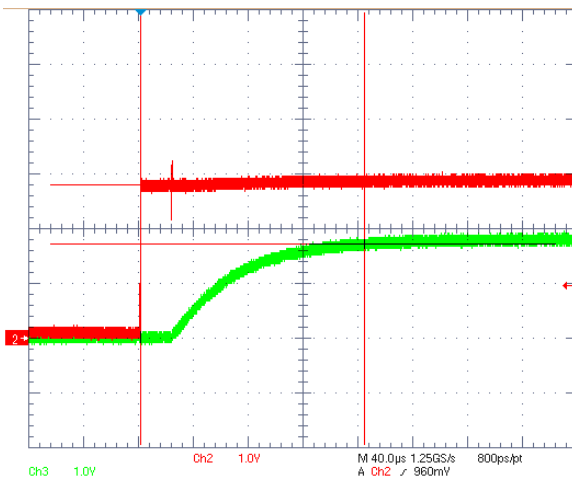

Figure 19. Line transient (V_{OUT} = 1.8 V; I_{OUT} = 10 mA, t_r = t_f = 1 µs)

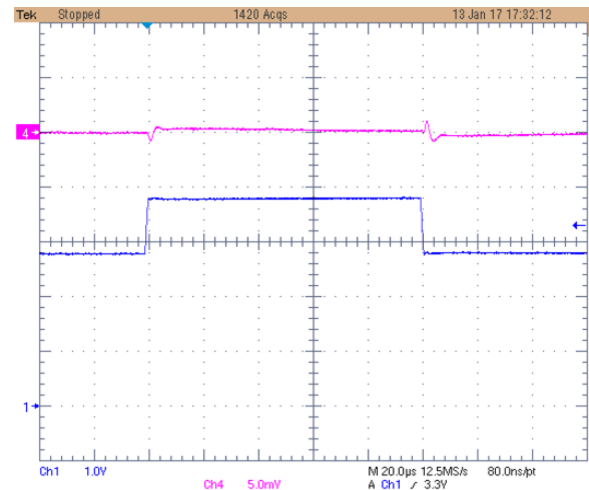

Figure 20. Output voltage vs. input voltage

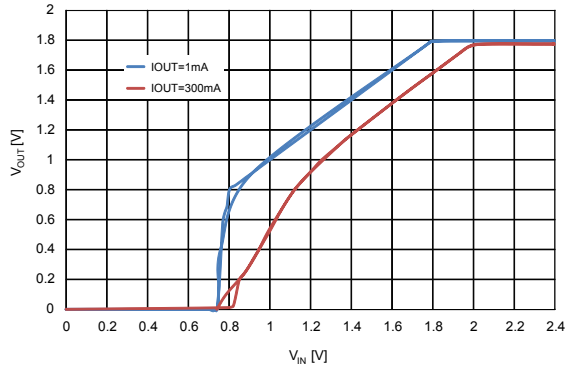
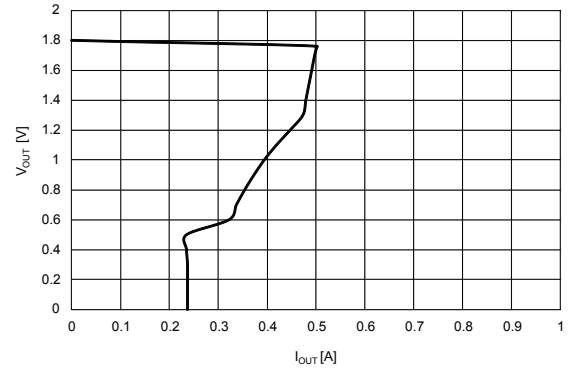

Figure 21. Output voltage vs. output current



8 Package information

In order to meet environmental requirements, ST offers these devices in different grades of **ECOPACK** packages, depending on their level of environmental compliance. ECOPACK specifications, grade definitions and product status are available at: www.st.com. ECOPACK is an ST trademark.

8.1 DFN4 1x1 package info

Figure 22. DFN4 1x1 package outline

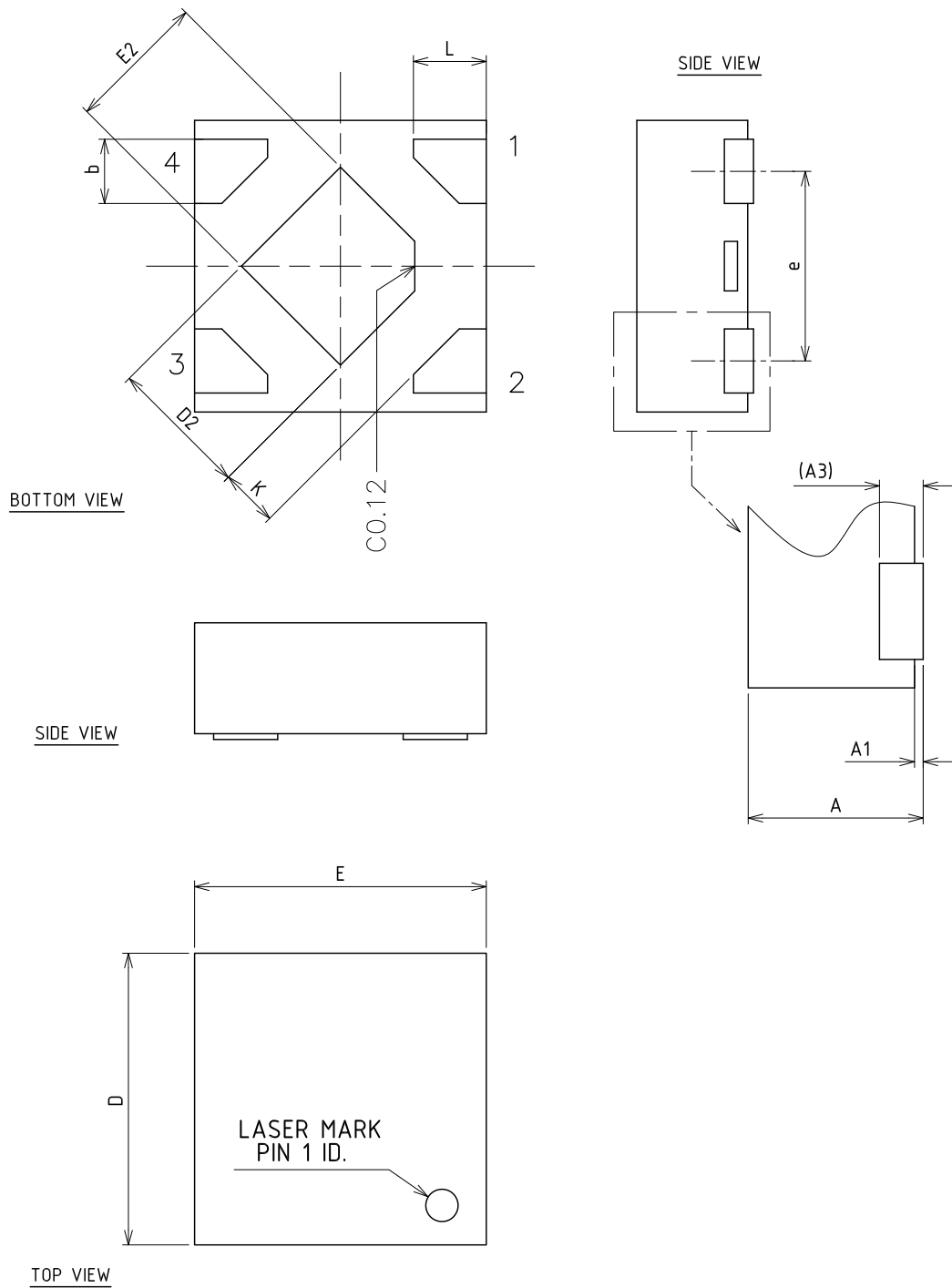

8405587_A

Table 7. DFN4 1x1 mechanical data

| Dim. | mm | | |
|------|------|------|------|
| | Min. | Typ. | Max. |
| A | 0.34 | 0.37 | 0.40 |
| A1 | 0 | 0.02 | 0.05 |
| A3 | | 0.10 | |
| b | 0.17 | 0.22 | 0.27 |
| D | 0.95 | 1.00 | 1.05 |
| D2 | 0.43 | 0.48 | 0.53 |
| E | 0.95 | 1.00 | 1.05 |
| E2 | 0.43 | 0.48 | 0.53 |
| e | | 0.65 | |
| L | 0.20 | 0.25 | 0.30 |
| K | 0.15 | | |

Figure 24. DFN4 1x1 tape outline

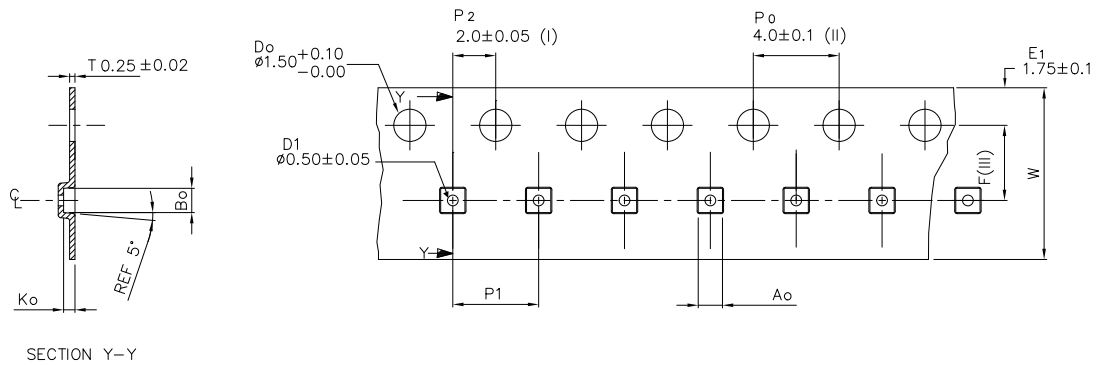

| | |
|----------------|----------------|
| A ₀ | 1.13 +/−0.05 |
| B ₀ | 1.13 +/−0.05 |
| K ₀ | 0.53 +/−0.05 |
| F | 3.50 +/−0.05 |
| P ₁ | 4.00 +/−0.10 |
| W | 8.00 +0.3/−0.1 |

- (I) Measured from centreline of sprocket hole to centreline of pocket.
- (II) Cumulative tolerance of 10 sprocket holes is ± 0.20 .
- (III) Measured from centreline of sprocket hole to centreline of pocket.
- (IV) Other material available.
- (V) Typical SR of form tape Max. 10° OHM/SR

ALL DIMENSIONS IN MILLIMETRES UNLESS OTHERWISE STATED.

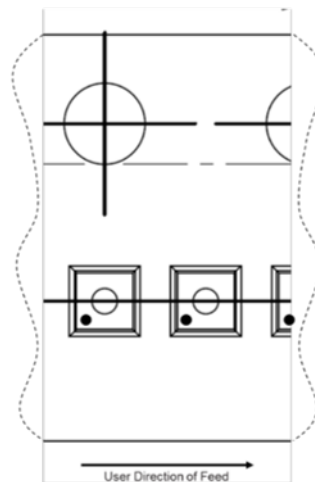
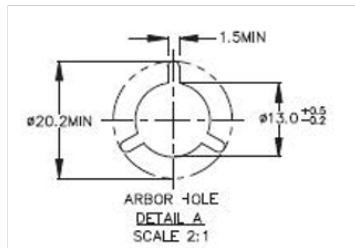
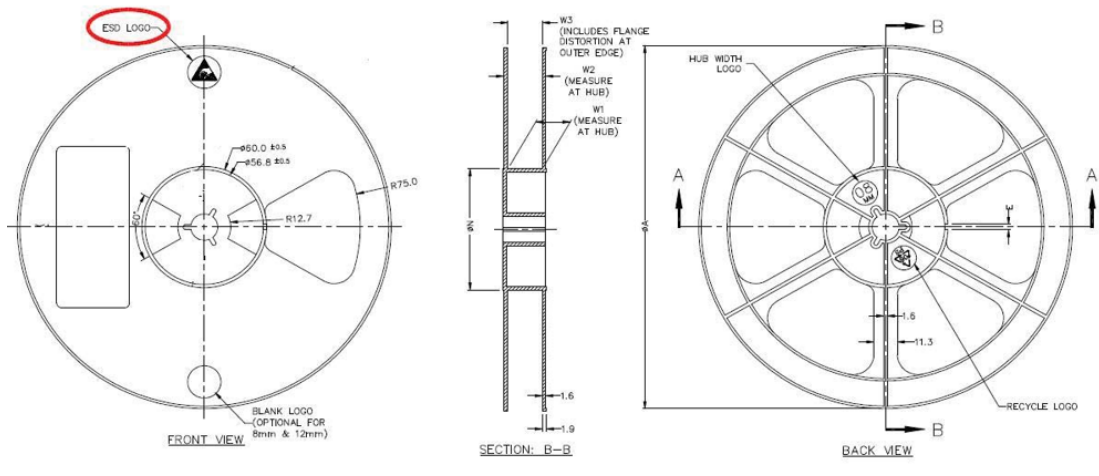

Figure 25. DFN4 1x1 reel outline



| Tape width (mm) | A max. | N min. | W1 max. | W2 max. | W3 min. / max. |
|-----------------|--------|--------|---------|---------|----------------|
| 8 | 180 | 60 | 8.4 | 14.4 | 7.9 / 10.9 |

9 Ordering information

Table 8. Order code

| Order code | Output voltage (V) | Auto-discharge | Marking |
|--------------------------------|--------------------|----------------|---------|
| LD59030DTPU105R ⁽¹⁾ | 1.05 | Yes | JQ |
| LD59030TPU105R ⁽¹⁾ | | No | KQ |
| LD59030DTPU12R | 1.2 | Yes | J5 |
| LD59030TPU12R ⁽¹⁾ | | No | K5 |
| LD59030DTPU18R | 1.8 | Yes | J7 |
| LD59030TPU18R ⁽¹⁾ | | No | K7 |
| LD59030DTPU25R | 2.5 | Yes | JA |
| LD59030TPU25R ⁽¹⁾ | | No | KA |
| LD59030DTPU28R | 2.8 | Yes | JC |
| LD59030TPU28R ⁽¹⁾ | | No | KC |
| LD59030DTPU30R | 3.0 | Yes | JF |
| LD59030TPU30R ⁽¹⁾ | | No | KF |
| LD59030DTPU33R | 3.3 | Yes | JJ |
| LD59030TPU33R ⁽¹⁾ | | No | KJ |

1. Available on request

Revision history

Table 9. Document revision history

| Date | Revision | Changes |
|-------------|----------|--|
| 28-Aug-2017 | 1 | Initial release. |
| 03-Nov-2017 | 2 | Datasheet promoted from preliminary data to datasheet. Update Figure 15: "Stability area vs. (COUT, ESR)". |
| 01-Jun-2018 | 3 | Updated: Figure 24. Tape dimensions. |
| 31-Jul-2018 | 4 | Updated: output voltage in Table 6. Dropout voltage at $I_{OUT} = 300$ mA. |
| 24-02-2020 | 5 | Updated Figure 14. |
| 02-Nov-2020 | 6 | Updated Section 8.1. |
| 24-Feb-2021 | 7 | Added footnote in Table 8. |
| 30-Mar-2021 | 8 | Updated: Thermal pad function in Table 1 Added: Note in Table 4 |

Contents

| | | |
|----------|---|-----------|
| 1 | Diagram | 2 |
| 2 | Pin configuration | 3 |
| 3 | Typical application | 4 |
| 4 | Maximum ratings | 5 |
| 5 | Electrical characteristics | 6 |
| 6 | Application information | 8 |
| 6.1 | Soft-start function | 8 |
| 6.2 | Output discharge function | 8 |
| 6.3 | Dropout voltage | 8 |
| 6.4 | Input and output capacitors | 8 |
| 7 | Typical characteristics | 9 |
| 8 | Package information | 13 |
| 8.1 | DFN4 1x1 package information | 14 |
| 9 | Ordering information | 19 |
| | Revision history | 20 |

List of tables

| | | |
|-----------------|---|----|
| Table 1. | Pin description | 3 |
| Table 2. | Absolute maximum ratings | 5 |
| Table 3. | Thermal data | 5 |
| Table 4. | ESD Performance | 5 |
| Table 5. | Electrical characteristics | 6 |
| Table 6. | Dropout voltage at $I_{OUT} = 300$ mA | 8 |
| Table 7. | DFN4 1x1 mechanical data | 15 |
| Table 8. | Order code | 19 |
| Table 9. | Document revision history | 20 |

List of figures

| | | |
|-------------------|--|----|
| Figure 1. | Block diagram | 2 |
| Figure 2. | Pin connection (top view) | 3 |
| Figure 3. | Typical application circuit | 4 |
| Figure 4. | Output voltage vs. temperature ($V_{OUT} = 1.8\text{ V}$; $I_{OUT} = 1\text{ mA}$) | 9 |
| Figure 5. | Output voltage vs. temperature ($V_{OUT} = 1.8\text{ V}$; $I_{OUT} = 300\text{ mA}$) | 9 |
| Figure 6. | Line regulation vs. temperature ($V_{IN} = 2.8\text{ V to } 5.5\text{ V}$; $V_{OUT} = 1.8\text{ V}$; $I_{OUT} = 10\text{ mA}$) | 9 |
| Figure 7. | Load regulation vs. temperature ($V_{OUT} = 1.8\text{ V}$; $I_{OUT} = 0\text{ to } 300\text{ mA}$) | 9 |
| Figure 8. | Quiescent current vs. temperature ($I_{OUT} = 0\text{ mA}$) | 10 |
| Figure 9. | Quiescent current vs. temperature ($I_{OUT} = 300\text{ mA}$) | 10 |
| Figure 10. | Shutdown current vs. temperature | 10 |
| Figure 11. | Dropout voltage vs. load current | 10 |
| Figure 12. | Quiescent current vs. output current ($V_{IN} = 2.8\text{ V}$; $V_{OUT} = 1.8\text{ V}$) | 10 |
| Figure 13. | Dropout voltage vs. temperature ($V_{OUT} = 1.8\text{ V}$; $I_{OUT} = 300\text{ mA}$) | 10 |
| Figure 14. | Supply voltage rejection vs. frequency | 11 |
| Figure 15. | Stability area vs. (C_{OUT} , ESR) | 11 |
| Figure 16. | Output noise spectral density ($V_{OUT} = 1.8\text{ V}$) | 11 |
| Figure 17. | Output noise spectral density ($V_{OUT} = 2.8\text{ V}$) | 11 |
| Figure 18. | Turn-on Time ($V_{OUT} = 1.8\text{ V}$; $I_{OUT} = 0\text{ A}$, $V_{IN} = 2.8\text{ V}$, $t_r = t_f = 1\text{ }\mu\text{s}$) | 11 |
| Figure 19. | Line transient ($V_{OUT} = 1.8\text{ V}$; $I_{OUT} = 10\text{ mA}$, $t_r = t_f = 1\text{ }\mu\text{s}$) | 11 |
| Figure 20. | Output voltage vs. input voltage | 12 |
| Figure 21. | Output voltage vs. output current | 12 |
| Figure 22. | DFN4 1x1 package outline | 14 |
| Figure 23. | DFN4 1x1 recommended footprint | 16 |
| Figure 24. | DFN4 1x1 tape outline | 17 |
| Figure 25. | DFN4 1x1 reel outline | 18 |

IMPORTANT NOTICE – PLEASE READ CAREFULLY

STMicroelectronics NV and its subsidiaries (“ST”) reserve the right to make changes, corrections, enhancements, modifications, and improvements to ST products and/or to this document at any time without notice. Purchasers should obtain the latest relevant information on ST products before placing orders. ST products are sold pursuant to ST’s terms and conditions of sale in place at the time of order acknowledgement.

Purchasers are solely responsible for the choice, selection, and use of ST products and ST assumes no liability for application assistance or the design of Purchasers’ products.

No license, express or implied, to any intellectual property right is granted by ST herein.

Resale of ST products with provisions different from the information set forth herein shall void any warranty granted by ST for such product.

ST and the ST logo are trademarks of ST. For additional information about ST trademarks, please refer to www.st.com/trademarks. All other product or service names are the property of their respective owners.

Information in this document supersedes and replaces information previously supplied in any prior versions of this document.

© 2021 STMicroelectronics – All rights reserved