

NCP2860

300 mA Very Low Noise, Low Dropout Linear Regulator

The NCP2860 is a low noise, low dropout linear regulator that is offered as a fixed output voltage regulator (2.77 V) and as an adjustable output regulator from 1.25 V to 5.80 V. It supplies 300 mA from a 3.0 V to 6.0 V input. The excellent performances that the NCP2860 features in terms of transient responses, PSRR and noise, make it an ideal solution for audio applications (e.g., audio amplifier drivers).

Features

- High Output Current (300 mA Max)
- Low Output Voltage Noise: 60 μ Vrms
- Low Dropout (150 mV @ $I_{out} = 300$ mA)
- Thermal Overload and Short Circuit Protections
- Very Low Consumption in Shutdown Mode (10 nA)
- High Power Supply Rejection Ratio (60 dB @ 1.0 kHz)
- $\overline{\text{FAULT}}$ Indicator
- Programmable Output Voltage
- Soft-Start
- Pb-Free Package is Available

Typical Applications

- Cellular Phone
- Handheld Instruments

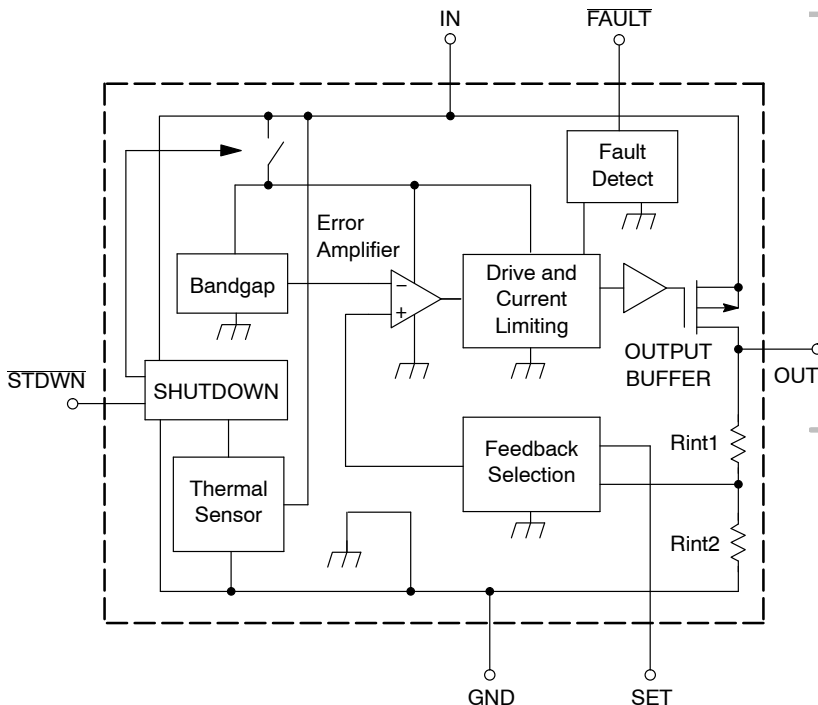

ON Semiconductor®

<http://onsemi.com>



**Micro8™
DM SUFFIX
CASE 846A**

MARKING DIAGRAM

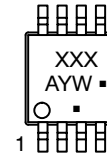

XXX = Specific Device Code
 A = Assembly Location
 Y = Year
 W = Work Week
 ■ = Pb-Free Package
 (Note: Microdot may be in either location)

PIN CONNECTIONS

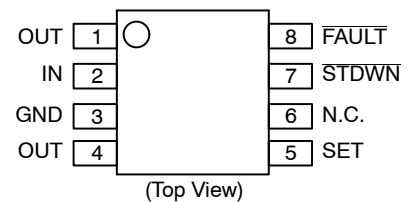

ORDERING INFORMATION

See detailed ordering and shipping information in the package dimensions section on page 10 of this data sheet.

NCP2860

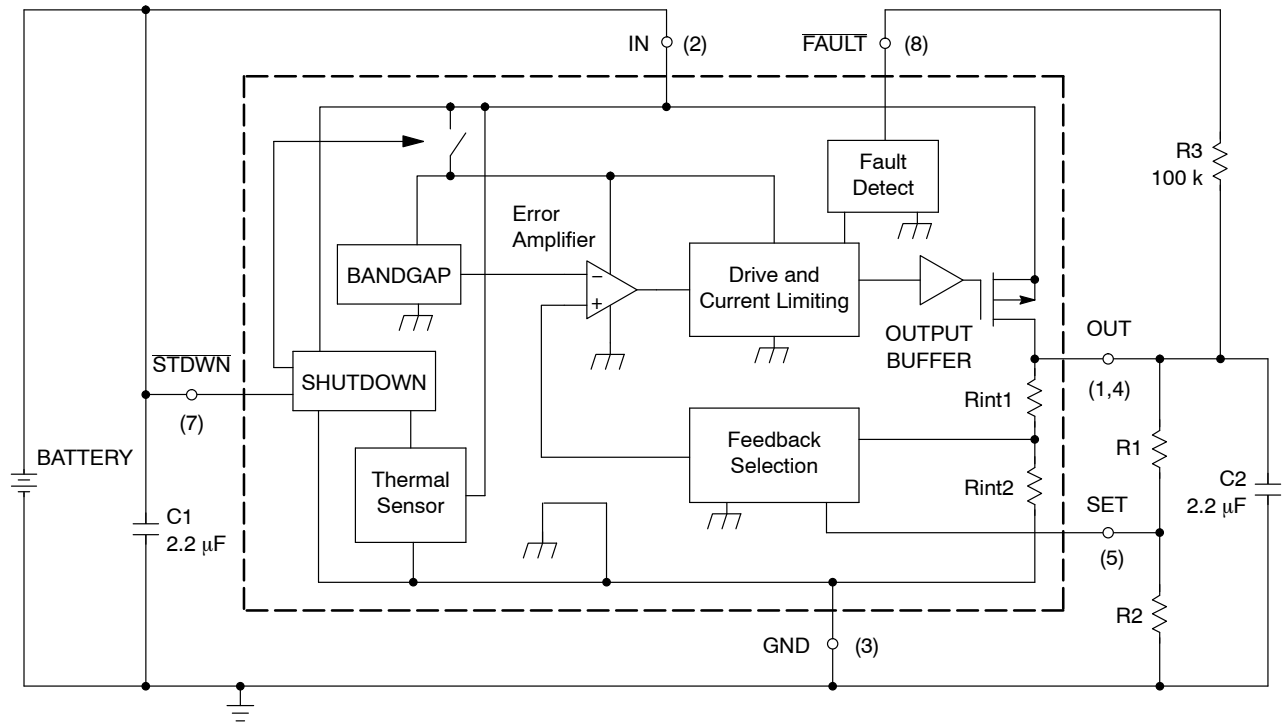

Figure 1. With External Output Voltage Adjustment

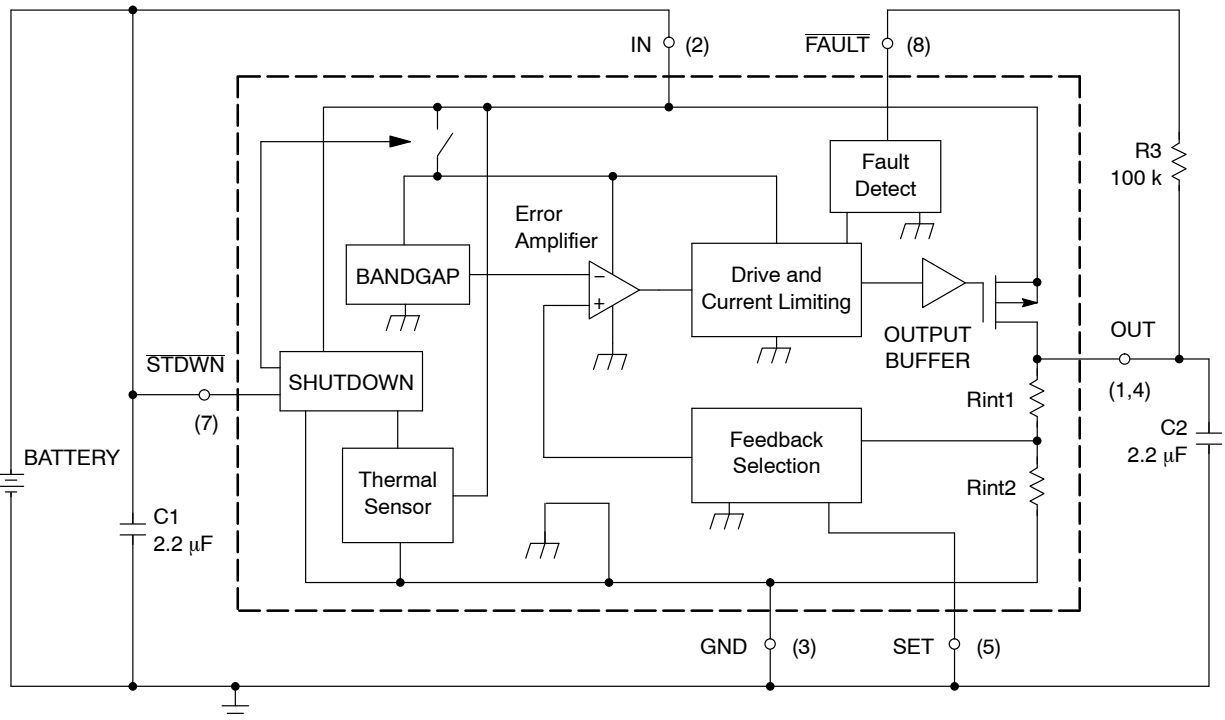

Figure 2. Application for 2.77 V Output Voltage

NCP2860

PIN DESCRIPTION

Pin	Name	Description
1, 4	OUT	"OUT" is the regulator output. A low ESR, bypass capacitor should be connected for stable operation.
2	IN	"IN" is the supply input that is connected to the power source (up to 6.0 V). Bypass with a 2.2 μ F capacitor.
3	GND	Ground
5	SET	Ground the "SET" pin to set the output voltage to 2.77 V. Connect to resistor–divider for ADJ output voltage. Refer to the "output voltage setting" paragraph if you need to program another value.
6	N.C.	This pin is non–connected.
7	STDWN	If the "STDWN" pin is low, the circuit enters the shutdown mode.
8	FAULT	The "FAULT" terminal is a high impedance, open drain output. If the circuit is out of regulation, the voltage pin goes low. Otherwise (normal operation or shutdown mode), this pin is high impedance. Connect the pin to ground, if unused.

MAXIMUM RATINGS

Rating	Symbol	Value	Unit
Input Voltage, Shutdown Pin, Voltage Range (Note 1)	V_{inmax}	-0.3, +6.0	V
Thermal Resistance (Note 2)	–	230	$^{\circ}$ C/W
Maximum Junction Temperature	T_{Jmax}	150	$^{\circ}$ C
Storage Temperature Range	T_{Smax}	- 65 to +150	$^{\circ}$ C
Lead Temperature (Soldering, 10s)	T_{Lmax}	300	$^{\circ}$ C
ESD Capability Human Body Model	–	2.0	kV
Machine Model	–	200	V
Latchup Capability @ 85 $^{\circ}$ C	–	+/-100	mA

Stresses exceeding Maximum Ratings may damage the device. Maximum Ratings are stress ratings only. Functional operation above the Recommended Operating Conditions is not implied. Extended exposure to stresses above the Recommended Operating Conditions may affect device reliability.

1. The recommended input voltage range for NCP2860 proper operation is 2.7 V to 6.0 V.
2. Circuit being mounted on a board that has no metal oxide traces attached to the leads. The addition of plated copper can lower the thermal resistance.

NCP2860

TYPICAL ELECTRICAL CHARACTERISTICS (Note 3) ($V_{in} = 3.6\text{ V}$, T_A from -25°C to $+85^\circ\text{C}$, unless otherwise noted.)

Characteristic for 2.77 V Fix Version SET = GND	Symbol	Min	Typ	Max	Unit
Output Voltage @ $I_{out} = 100\ \mu\text{A}$, $300\ \text{mA}$, $V_{in} = 3.2\ \text{V}$ and $T_A = 25^\circ\text{C}$ T_A from -25°C to $+85^\circ\text{C}$	V_{out}	2.73 2.70	2.77 2.77	2.81 2.84	V
Supply Current @ $I_{out} = 0$, $V_{in} = 3.2\ \text{V}$	I_{cc-0}	-	355	700	μA
Supply Current @ $I_{out} = 300\ \text{mA}$, $V_{in} = 3.2\ \text{V}$	I_{cc-300}	-	1.1	-	mA
Supply Current in Shutdown Mode (STDWN Pin Grounded) @ $T_A = 25^\circ\text{C}$	I_{stdwn}	-	0.01	1.0	μA
Dropout Voltage @ $I_{out} = 1.0\ \text{mA}$ (Note 4)	V_{drop-1}	-	0.6	-	mV
Dropout Voltage @ $I_{out} = 150\ \text{mA}$ (Note 4)	$V_{drop-150}$	-	75	150	mV
Dropout Voltage @ $I_{out} = 300\ \text{mA}$ (Note 4)	$V_{drop-300}$	-	150	250	mV
SET Input Leakage Current @ $V_{SET} = (0 - 0.2)\ \text{V}$ and $T_A = 25^\circ\text{C}$	I_{leak}	-	10	200	nA
Short Circuit Output Current Limitation @ $V_{in} = 3.2\ \text{V}$	I_{max_cc}	310	465	700	mA
Start-Up Current Limitation @ $T_A = 25^\circ\text{C}$, $V_{in} = 3.2\ \text{V}$	I_{max_stup}	-	220	-	mA
Line Regulation, V_{in} varying between $3.0\ \text{V}$ and $6.0\ \text{V}$ @ $I_{out} = 1.0\ \text{mA}$	LineReg1	-0.1	0.01	0.1	%/V
Line Regulation, V_{in} varying between $3.0\ \text{V}$ and $6.0\ \text{V}$ @ $I_{out} = 10\ \text{mA}$	LineReg2	-0.1	0.01	0.1	%/V
Load Regulation, I_{out} varying from $0.1\ \text{mA}$ to $300\ \text{mA}$ @ $V_{in} = 3.2\ \text{V}$	LoadReg2	-	0.001	-	%/mA
Output Voltage Noise @ $C_{out} = 22\ \mu\text{F}$ (Note 5) $10\ \text{Hz} < f < 10\ \text{kHz}$ $10\ \text{Hz} < f < 100\ \text{kHz}$	-	-	35 60	-	μV_{rms}
Power Supply Rejection Ratio @ $1.0\ \text{kHz}$ and $I_{out} = 100\ \text{mA}$	PSRR	-	60	-	dB
Shutdown Threshold (with hysteresis) @ $V_{in} = 5.0\ \text{V}$	V_{stdwn}	0.63	-	2.65	V
Shutdown Pin Bias Current @ STDWN = IN or GND and $T_A = 25^\circ\text{C}$	I_{stdwn}	-	-	100	nA
FAULT Detection Voltage @ $I_{out} = 200\ \text{mA}$	$V_{fault-th}$	-	120	280	mV
FAULT Output Low Voltage @ $I_{sink} = 2.0\ \text{mA}$	$V_{fault-out}$	-	0.15	0.4	V
FAULT Output OFF Leakage Current @ $T_A = 25^\circ\text{C}$	I_{fault}	-	0.1	100	nA
Start-Up Time @ $C_{out} = 10\ \mu\text{F}$, $I_{out} = 100\ \text{mA}$ (Note 5)	T_{stup}	-	60	-	μs
Thermal Shutdown Threshold	T_{limit}	-	170	-	$^\circ\text{C}$
Thermal Shutdown Hysteresis	H_{temp}	-	30	-	$^\circ\text{C}$

- The specification gives the targeted values. This specification may have to be slightly adjusted after the temperature characterization of the die.
- The dropout voltage is defined as $(V_{in} - V_{out})$ when V_{out} is $100\ \text{mV}$ below the value of V_{out} when $V_{in} > 3\ \text{V}$.
- Refer to characterization curves for more details.

NCP2860

TYPICAL ELECTRICAL CHARACTERISTICS (Note 3) ($V_{in} = 3.6\text{ V}$, T_A from -25°C to $+85^\circ\text{C}$, unless otherwise noted.)

Characteristic for Adjustable Version	Symbol	Min	Typ	Max	Unit
Adjustable Output Voltage Range @ $V_{in} = V_{out} + 0.5\text{ V}$ and $V_{in} > 3\text{ V}$, $I_{out} = (1 - 300)\text{ mA}$	V_{out}	1.25		5.80	V
Supply Current @ $I_{out} = 0$, $V_{in} = 6\text{ V}$, $V_{out} = 3.3\text{ V}$	I_{cc-0}		400	900	μA
Supply Current @ $I_{out} = 300$, $V_{in} = 6\text{ V}$, $V_{out} = 3.3\text{ V}$	I_{cc-300}	-	1180	1400	μA
Dropout Voltage @ $I_{out} = 1.0\text{ mA}$, $V_{out} = 3.3\text{ V}$	V_{drop-1}		0.7		mV
Dropout Voltage @ $I_{out} = 150\text{ mA}$, $V_{out} = 3.3\text{ V}$	$V_{drop-150}$		80	150	mV
Dropout Voltage @ $I_{out} = 300\text{ mA}$, $V_{out} = 3.3\text{ V}$	$V_{drop-300}$		155	200	mV
SET Threshold (SET = OUT) @ $I_{out} = 1\text{ mA}$ and $V_{in} = (3.0 - 6)\text{ V}$, $T_A = 25^\circ\text{C}$ T_A from -25°C to $+85^\circ\text{C}$	V_{ref}	1.226 1.22	1.244 1.244	1.262 1.27	V
SET Input Leakage Current @ $V_{SET} = 1.25\text{ V}$ and $T_A = 25^\circ\text{C}$	I_{leak}		10	200	nA
Short Circuit Output Current Limitation @ $V_{in} = V_{out} + 0.5\text{ V}$, $V_{out} = (2.5 - 3.3)\text{ V}$, $T_A = 25^\circ\text{C}$	I_{max_cc}	310	495	700	mA
Start-Up Current Limitation @ $T_A = 25^\circ\text{C}$, $V_{in} = 3.8\text{ V}$, $V_{out} = 3.3\text{ V}$	I_{max_stup}		200		mA
Line Regulation, $V_{in} = (3.8 - 6)\text{ V}$ @ $I_{out} = 1.0\text{ mA}$ and ($V_{out} = 3.3\text{ V}$)	$Line_{Reg1}$		0.1		%/V
Line Regulation, $V_{in} = (3.8 - 6)\text{ V}$ @ $I_{out} = 300\text{ mA}$, $V_{out} = 3.3\text{ V}$	$Line_{Reg300}$	-	0.3	-	%/V
Load Regulation, I_{out} varying from 0.1 mA to 300 mA, $V_{out} = 3.3\text{ V}$, @ $V_{in} = 3.8\text{ V}$	$Load_{Reg3V3}$		0.001		%/mA
Load Regulation, I_{out} varying from 0.1 mA to 300 mA and $V_{out} = 2.5\text{ V}$, $V_{in} = 3.0\text{ V}$	$Load_{Reg2V5}$	-	0.0005	-	%/mA
Output Voltage Noise @ SET = GND, $C_{out} = 22\text{ }\mu\text{F}$ (Note 5) 10 Hz < f < 10 kHz 10 Hz < f < 100 kHz	Adjustable	-	35 60		μVrms
Power Supply Rejection Ratio @ 1.0 kHz, $V_{out} = 3.3\text{ V}$ and $I_{out} = 10\text{ mA}$	PSRR		69		dB
Shutdown Threshold (with hysteresis) @ $V_{in} = 5.0\text{ V}$	V_{stdwn}	0.63		2.65	V
Shutdown Pin Bias Current @ STDWN = IN or GND and $T_A = 25^\circ\text{C}$	I_{stdwn}			100	nA
FAULT Detection Voltage @ $I_{out} = 200\text{ mA}$	$V_{fault-th}$		120	280	mV
FAULT Output Low Voltage @ $I_{sink} = 2.0\text{ mA}$	$V_{fault-out}$		0.15	0.4	V
FAULT Output OFF Leakage Current @ $T_A = 25^\circ\text{C}$	I_{fault}		0.1	100	nA
Start-Up Time @ $C_{out} = 10\text{ }\mu\text{F}$, $V_{out} = 3.3\text{ V}$, $I_{out} = 100\text{ mA}$ (Note 5)	T_{stup}		80		μs
Thermal Shutdown Threshold/Hysteresis	T_{limit}/H_{temp}		170/ 30		$^\circ\text{C}$

- The specification gives the targeted values. This specification may have to be slightly adjusted after the temperature characterization of the die.
- The dropout voltage is defined as ($V_{in} - V_{out}$) when V_{out} is 100 mV below the value of V_{out} when $V_{in} > 3\text{ V}$.
- Refer to characterization curves for more details.

NCP2860

TYPICAL ELECTRICAL CHARACTERISTICS

($V_{in} = V_{out} + 0.5\text{ V}$, $C_{in} = C_{out} = 2.2\ \mu\text{F}$, SET = GND, $T_A = 25^\circ\text{C}$, unless otherwise noted.)

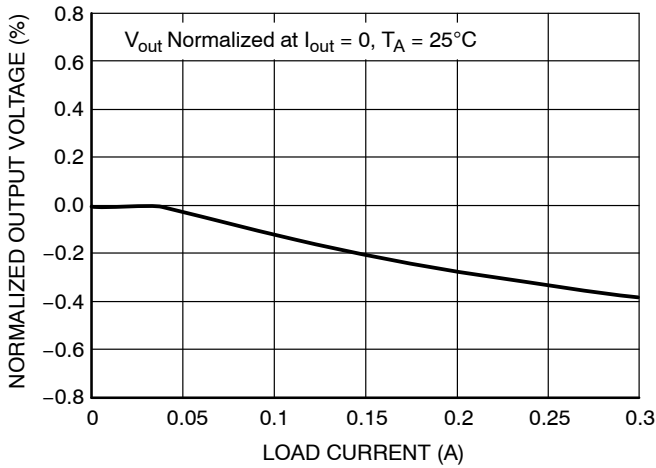

Figure 1. Normalized Output Voltage vs. Load Current

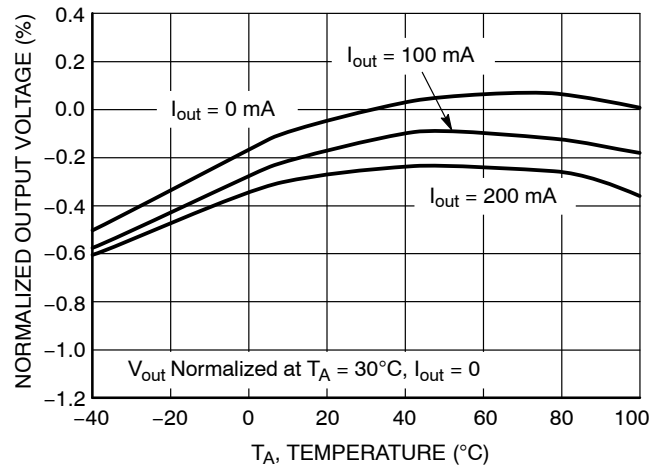

Figure 2. Normalized Output Voltage vs. Temperature

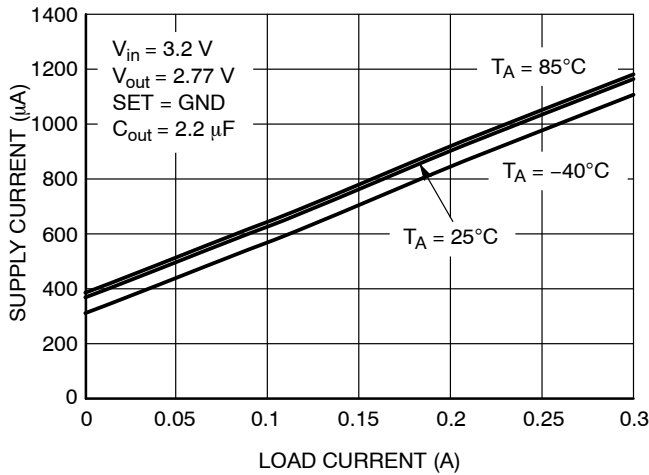

Figure 3. Supply Current vs. Load Current

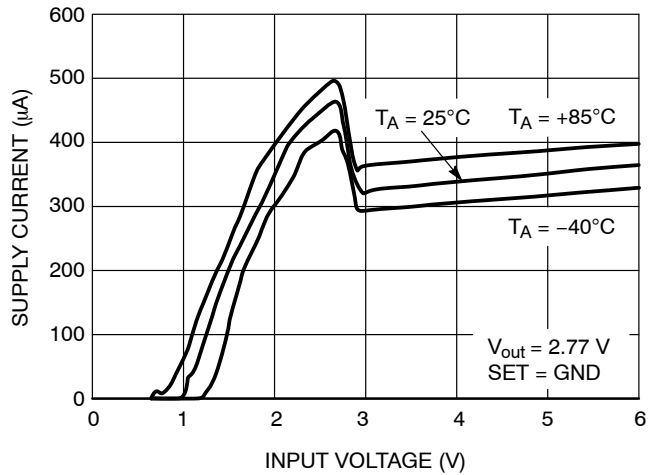

Figure 4. No Load Supply Current vs. Input Voltage

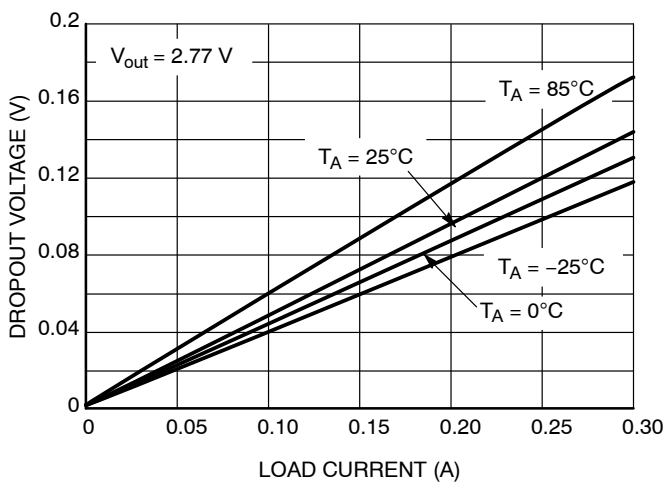

Figure 5. Dropout Voltage vs. Load Current

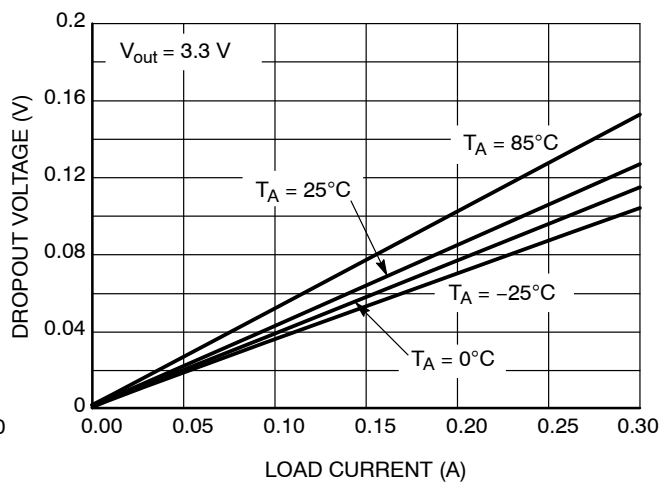

Figure 6. Dropout Voltage vs. Load Current

NCP2860

TYPICAL ELECTRICAL CHARACTERISTICS

($V_{in} = V_{out} + 0.5\text{ V}$, $C_{in} = C_{out} = 2.2\text{ }\mu\text{F}$, SET = GND, $T_A = 25^\circ\text{C}$, unless otherwise noted.)

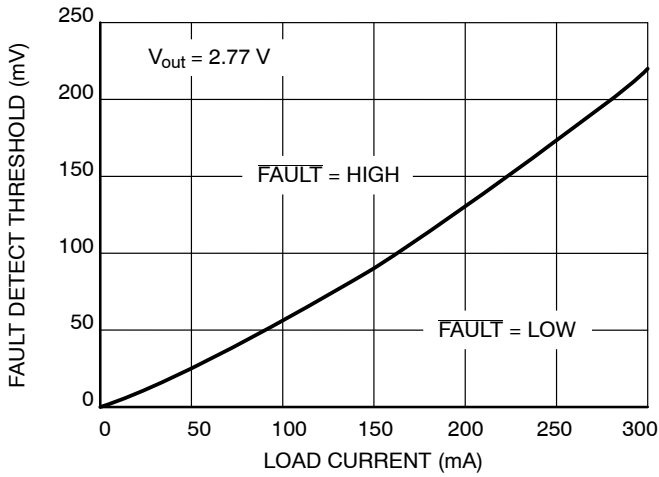

Figure 7. Fault Detect Threshold vs. Load Current

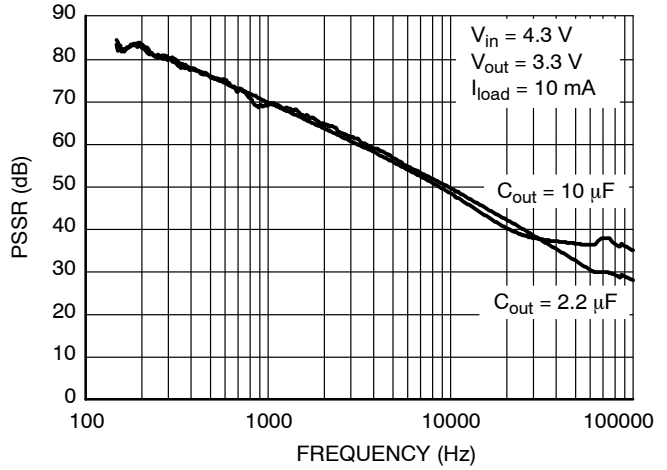

Figure 8. Power Supply Rejection Ratio

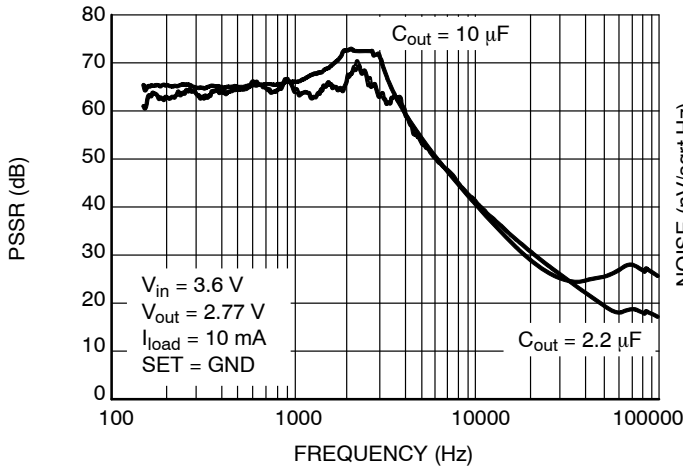

Figure 9. Power Supply Rejection Ratio

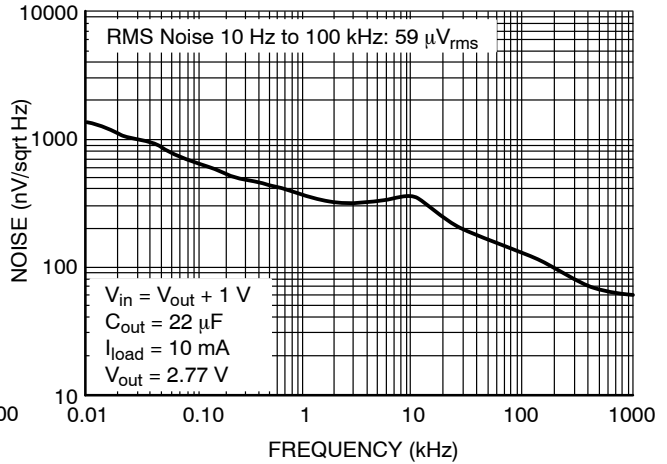

Figure 10. Output Noise Spectral Density

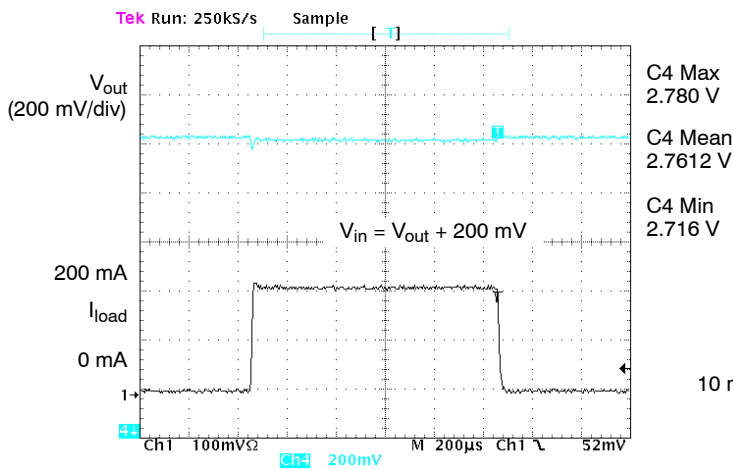

Figure 11. Load Transient Response

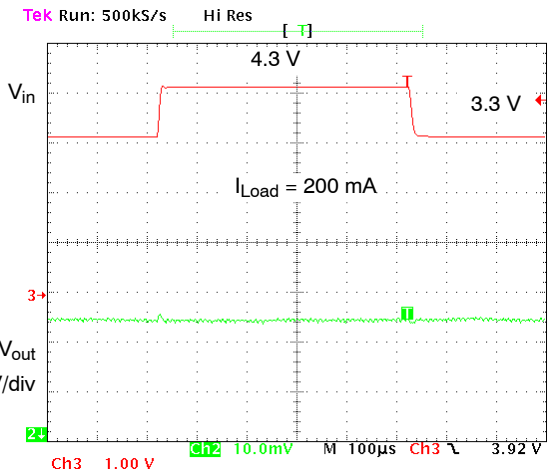

Figure 12. Line Transient

NCP2860

TYPICAL ELECTRICAL CHARACTERISTICS

($V_{in} = V_{out} + 0.5\text{ V}$, $C_{in} = C_{out} = 2.2\ \mu\text{F}$, SET = GND, $T_A = 25^\circ\text{C}$, unless otherwise noted.)

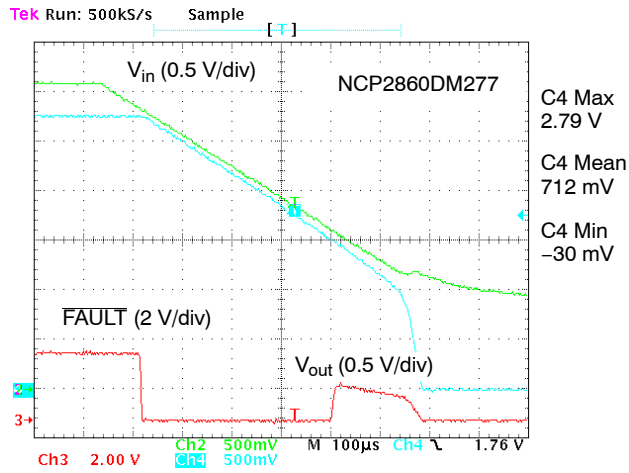

Figure 13. Power-Down Response ($I_{load} = 100\text{ mA}$)

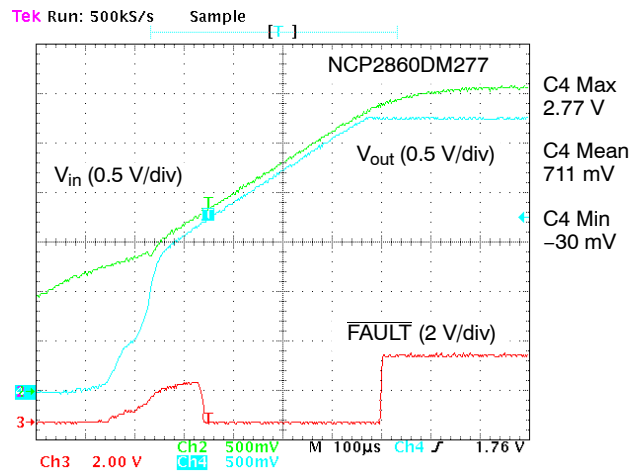

Figure 14. Power-Up Response ($I_{load} = 100\text{ mA}$)

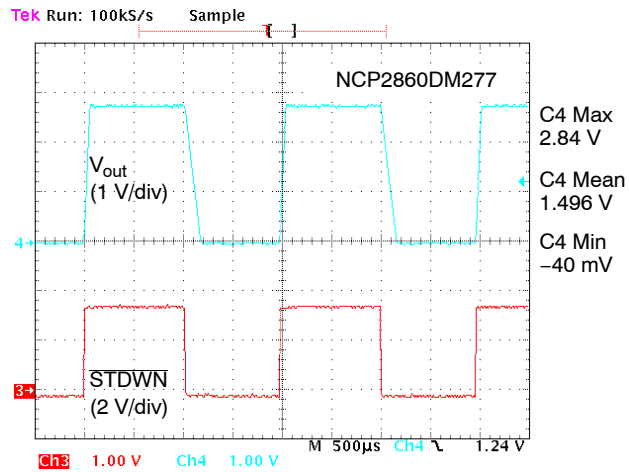

Figure 15. Shutdown/Power-Up
($V_{in} = V_{out} + 0.5\text{ V}$, $I_{load} = 50\text{ mA}$)

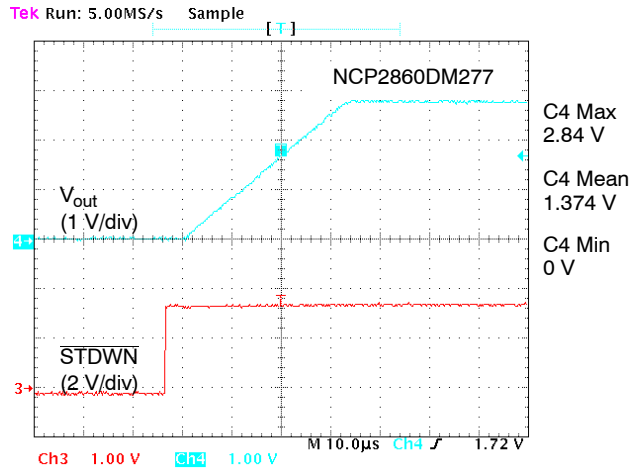

Figure 16. Shutdown/Power-Up
($V_{in} = V_{out} + 0.5\text{ V}$, $I_{load} = 0\text{ mA}$)

DETAILED OPERATING DESCRIPTION

Internal Pass Transistor

The NCP2860 incorporates a 0.5 Ω typical P-channel MOSFET pass transistor. The P-channel MOSFET requires no drive current and then compared to the PNP based regulators, this solution drastically reduces the quiescent current and associated losses.

Shutdown Block

The circuit turns into shutdown mode when the shutdown pin is in low state. In this mode, the internal biasing current sources are disconnected so that the pass transistor is off and the consumption reduced to a minimum value. Practically, the shutdown consumption is in the range of 10 nA. When this function is unused, "IN" is generally applied to the shutdown pin.

Current Limitation

The NCP2860 incorporates a short circuit protection that prevents the pass transistor current from exceeding 465 mA typically. The current limit is set to 220 mA during the start-up phase.

Thermal Protection

The thermal protection protects the die against excessive overheating. Practically, when the junction temperature exceeds 170°C for the 2.77 V option and 150°C for the 3.0 V option, an internal thermal sensor sends a logical signal to the shutdown block so that the circuit enters the shutdown mode. Once the die has cooled enough (typically 30°C), the circuit enters a new working phase.

Output Voltage Setting

- a) The output voltage is set by internal resistor divider to 2.77 V for NCP2860DM277R2 device. The "SET" pin must be grounded or pulled below 0.2 V.
- b) The output voltage can also be programmed to a different value for NCP2860DMADJR2G device. In this case a portion of the output voltage acquired by the external resistor divider must be applied to the "SET" pin. Do not leave the "SET" pin unconnected. If a (R1, R2) external resistors divider is used, then output voltage is given by equation:

$$V_{out} = (1 + R1/R2) * V_{ref}$$

Therefore, as V_{ref} typically equals 1.244 V:

$$V_{out} = 1.244 * (1 + R1/R2).$$

Now if R1 and R2 are high impedance resistors, the leakage current that is absorbed by the "SET" pin, may have to be taken into account as follows:

$$V_{out} = [1.244 * (1 + R1/R2)] + (R1 * I_{lk})$$

where I_{lk} is the "SET" pin leakage current.

If the output voltage is directly applied to the "SET" pin, $V_{out} = V_{ref} = 1.244$ V.

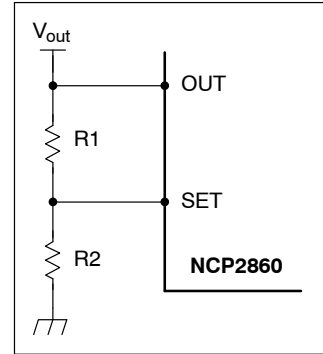

Regulation

The circuit incorporates a transconductance error amplifier. The error amplifier output varies in response to load and input voltage variations to control the pass transistor current so that the "OUT" pin delivers the wished voltage. No compensation capacitor is required.

Fault Detection Circuitry

The circuit detects when the input-output differential voltage is too low to ensure a correct load and line regulation at the output. The input-output differential threshold scales proportionally with the load current to be always just higher than the dropout.

When the circuit detects a fault condition, an internal switch connects "FAULT" to ground. In normal operation, the "FAULT" terminal is an open-drain-N-channel MOSFET and if a pull-up resistor is connected between "OUT" and "FAULT", "FAULT" goes high. The pullup resistor is generally selected in the range of 100 kΩ to minimize the current consumption.

Application Information

It is recommended to use 2.2 μF capacitors on the input and on the output of the NCP2860. Capacitor type is not very critical. Simply the ESR should be lower than 0.5 Ω to ensure a stable operation over the temperature and output current ranges. It could be convenient to increase the capacitor size and its quality (lower ESR) only if it was necessary to further improve the noise performances, the Power Supply Rejection Ratio or the fast transient response.

NCP2860

ORDERING INFORMATION

Device	Output Voltage (V)	Marking Code	Package	Shipping†
NCP2860DM277R2G	2.77	LC2	Micro8 (Pb-Free)	4000 / Tape & Reel
NCP2860DMADJR2G	Adjustable	AAA	Micro8 (Pb-Free)	4000 / Tape & Reel

†For information on tape and reel specifications, including part orientation and tape sizes, please refer to our Tape and Reel Packaging Specifications Brochure, BRD8011/D.

The product described herein (NCP2860), may be covered by the following U.S. patents: 6,664,773; 6,791,390. There may be other patents pending. Micro8 is a trademark of International Rectifier.

MECHANICAL CASE OUTLINE PACKAGE DIMENSIONS

ON Semiconductor®



SCALE 2:1

Micro8 CASE 846A-02 ISSUE K

DATE 16 JUL 2020

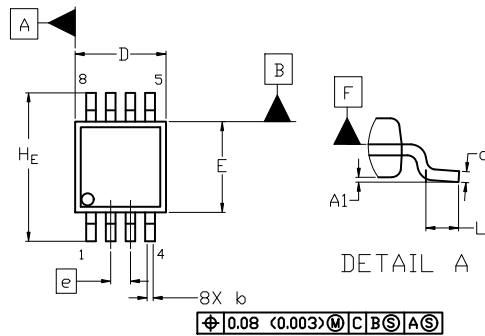

TOP VIEW

NOTE 3

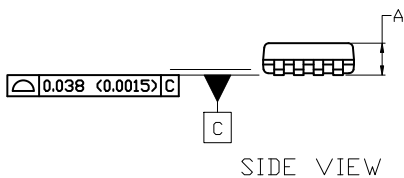

SIDE VIEW

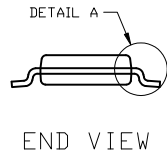

END VIEW

NOTES:

1. DIMENSIONING AND TOLERANCING PER ASME Y14.5M, 2009.
2. CONTROLLING DIMENSION: MILLIMETERS
3. DIMENSION *b* DOES NOT INCLUDE DAMBAR PROTRUSION. ALLOWABLE PROTRUSION SHALL BE 0.10 mm IN EXCESS OF MAXIMUM MATERIAL CONDITION.
4. DIMENSIONS *D* AND *E* DO NOT INCLUDE MOLD FLASH, PROTRUSION OR GATE BURRS. MOLD FLASH, PROTRUSIONS, OR GATE BURRS SHALL NOT EXCEED 0.15 mm PER SIDE. DIMENSION *E* DOES NOT INCLUDE INTERLEAD FLASH OR PROTRUSION. INTERLEAD FLASH OR PROTRUSION SHALL NOT EXCEED 0.25 mm PER SIDE. DIMENSIONS *D* AND *E* ARE DETERMINED AT DATUM *F*.
5. DATUMS *A* AND *B* ARE TO BE DETERMINED AT DATUM *F*.
6. *A1* IS DEFINED AS THE VERTICAL DISTANCE FROM THE SEATING PLANE TO THE LOWEST POINT ON THE PACKAGE BODY.

⌀ 0.08 (0.003) M C B S A S

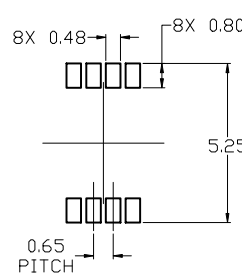

RECOMMENDED
MOUNTING FOOTPRINT

DIM	MILLIMETERS		
	MIN.	NDM.	MAX.
A	---	---	1.10
A1	0.05	0.08	0.15
<i>b</i>	0.25	0.33	0.40
<i>c</i>	0.13	0.18	0.23
<i>D</i>	2.90	3.00	3.10
<i>E</i>	2.90	3.00	3.10
<i>e</i>	0.65 BSC		
<i>H_E</i>	4.75	4.90	5.05
<i>L</i>	0.40	0.55	0.70

For additional information on our Pb-Free strategy and soldering details, please download the ON Semiconductor Soldering and Mounting Techniques Reference Manual, SOLDERM/D.

GENERIC MARKING DIAGRAM*

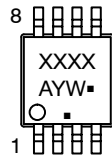

- XXXX = Specific Device Code
- A = Assembly Location
- Y = Year
- W = Work Week
- = Pb-Free Package

(Note: Microdot may be in either location)

*This information is generic. Please refer to device data sheet for actual part marking. Pb-Free indicator, "G" or microdot "▪", may or may not be present. Some products may not follow the Generic Marking.

STYLE 1:

1. SOURCE
2. SOURCE
3. SOURCE
4. GATE
5. DRAIN
6. DRAIN
7. DRAIN
8. DRAIN

STYLE 2:

1. SOURCE 1
2. GATE 1
3. SOURCE 2
4. GATE 2
5. DRAIN 2
6. DRAIN 2
7. DRAIN 1
8. DRAIN 1

STYLE 3:

1. N-SOURCE
2. N-GATE
3. P-SOURCE
4. P-GATE
5. P-DRAIN
6. P-DRAIN
7. N-DRAIN
8. N-DRAIN

DOCUMENT NUMBER:	98ASB14087C	Electronic versions are uncontrolled except when accessed directly from the Document Repository. Printed versions are uncontrolled except when stamped "CONTROLLED COPY" in red.
DESCRIPTION:	MICRO8	PAGE 1 OF 1

ON Semiconductor and ON are trademarks of Semiconductor Components Industries, LLC dba ON Semiconductor or its subsidiaries in the United States and/or other countries. ON Semiconductor reserves the right to make changes without further notice to any products herein. ON Semiconductor makes no warranty, representation or guarantee regarding the suitability of its products for any particular purpose, nor does ON Semiconductor assume any liability arising out of the application or use of any product or circuit, and specifically disclaims any and all liability, including without limitation special, consequential or incidental damages. ON Semiconductor does not convey any license under its patent rights nor the rights of others.

onsemi, **Onsemi**, and other names, marks, and brands are registered and/or common law trademarks of Semiconductor Components Industries, LLC dba "**onsemi**" or its affiliates and/or subsidiaries in the United States and/or other countries. **onsemi** owns the rights to a number of patents, trademarks, copyrights, trade secrets, and other intellectual property. A listing of **onsemi**'s product/patent coverage may be accessed at www.onsemi.com/site/pdf/Patent-Marking.pdf. **onsemi** reserves the right to make changes at any time to any products or information herein, without notice. The information herein is provided "as-is" and **onsemi** makes no warranty, representation or guarantee regarding the accuracy of the information, product features, availability, functionality, or suitability of its products for any particular purpose, nor does **onsemi** assume any liability arising out of the application or use of any product or circuit, and specifically disclaims any and all liability, including without limitation special, consequential or incidental damages. Buyer is responsible for its products and applications using **onsemi** products, including compliance with all laws, regulations and safety requirements or standards, regardless of any support or applications information provided by **onsemi**. "Typical" parameters which may be provided in **onsemi** data sheets and/or specifications can and do vary in different applications and actual performance may vary over time. All operating parameters, including "Typicals" must be validated for each customer application by customer's technical experts. **onsemi** does not convey any license under any of its intellectual property rights nor the rights of others. **onsemi** products are not designed, intended, or authorized for use as a critical component in life support systems or any FDA Class 3 medical devices or medical devices with a same or similar classification in a foreign jurisdiction or any devices intended for implantation in the human body. Should Buyer purchase or use **onsemi** products for any such unintended or unauthorized application, Buyer shall indemnify and hold **onsemi** and its officers, employees, subsidiaries, affiliates, and distributors harmless against all claims, costs, damages, and expenses, and reasonable attorney fees arising out of, directly or indirectly, any claim of personal injury or death associated with such unintended or unauthorized use, even if such claim alleges that **onsemi** was negligent regarding the design or manufacture of the part. **onsemi** is an Equal Opportunity/Affirmative Action Employer. This literature is subject to all applicable copyright laws and is not for resale in any manner.

PUBLICATION ORDERING INFORMATION

LITERATURE FULFILLMENT:

Email Requests to: orderlit@onsemi.com

onsemi Website: www.onsemi.com

TECHNICAL SUPPORT

North American Technical Support:

Voice Mail: 1 800-282-9855 Toll Free USA/Canada

Phone: 011 421 33 790 2910

Europe, Middle East and Africa Technical Support:

Phone: 00421 33 790 2910

For additional information, please contact your local Sales Representative

◇