

Features

- Internally frequency compensated
- Large DC voltage gain: 100 dB
- Wide bandwidth (unity gain: 1.1 MHz temperature compensated)
- Very low supply current per operator (500 μ A)
- Low input bias current: 20 nA (temperature compensated)
- Low input offset current: 2 nA
- Input common-mode voltage range includes ground
- Differential input voltage range equal to the power supply voltage
- Large output voltage swing 0 V to $V_{CC} - 1.5$ V
- Internal ESD protection:
 - 2 kV HBM
 - 200 V MM

Description

This circuit consists of two independent, high-gain, internally frequency-compensated operational amplifiers, designed specifically for automotive and industrial control systems. It operates from a single power supply over a wide range of voltages. The low power supply drain is independent of the magnitude of the power supply voltage.

Application areas include transducer amplifiers, DC gain blocks and all the conventional op-amp circuits which now can be more easily implemented in single power supply systems. For example, these circuits can be directly supplied from standard +5 V which is used in logic systems and will easily provide the required interface electronics without requiring any additional power supply.

In linear mode, the input common-mode voltage range includes ground and the output voltage can

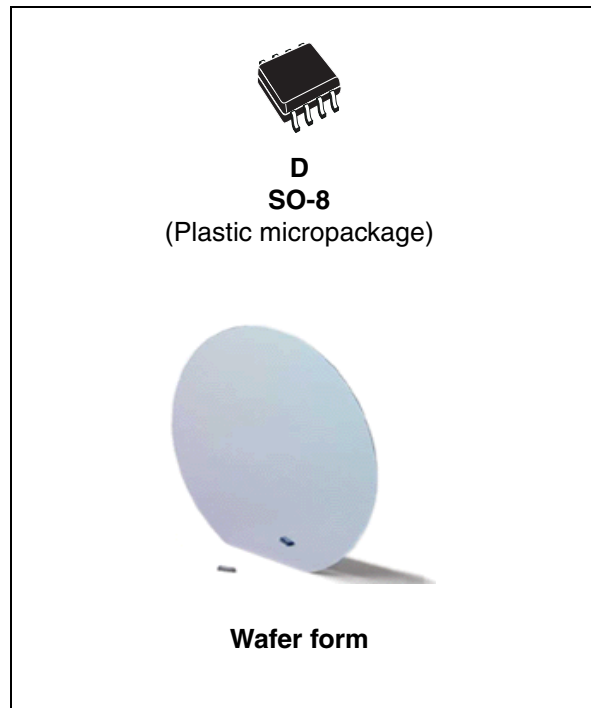

also swing to ground, even though operated from a single power supply.

1 Schematic diagram

Figure 1. Schematic diagram (1/2 LM2904WH)

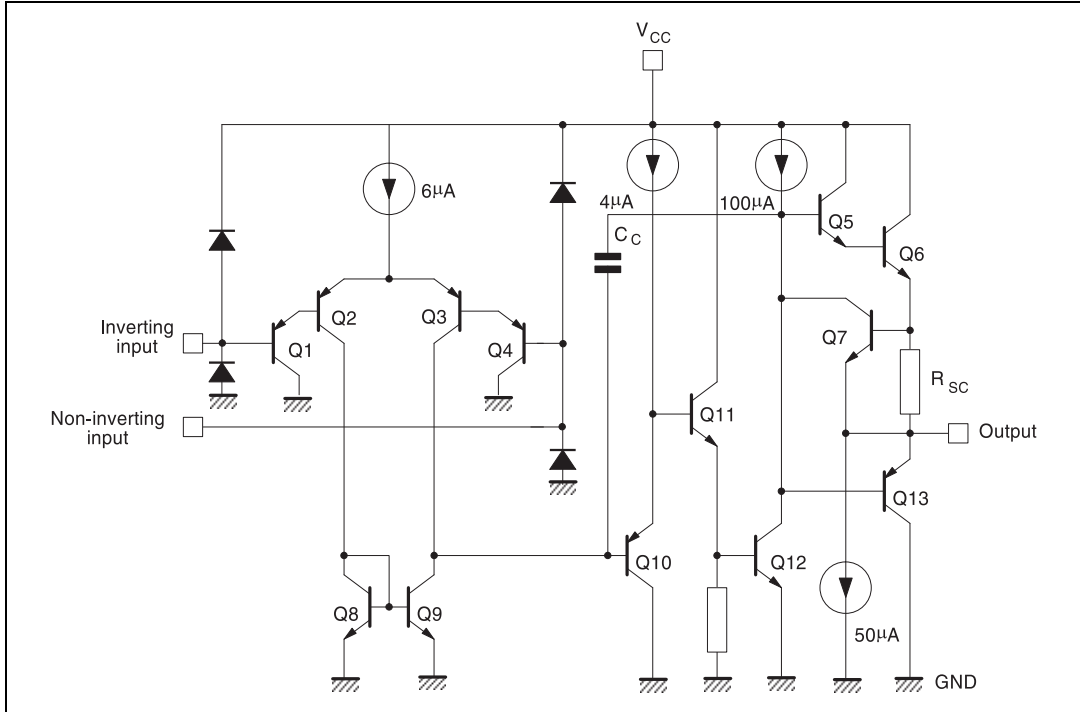
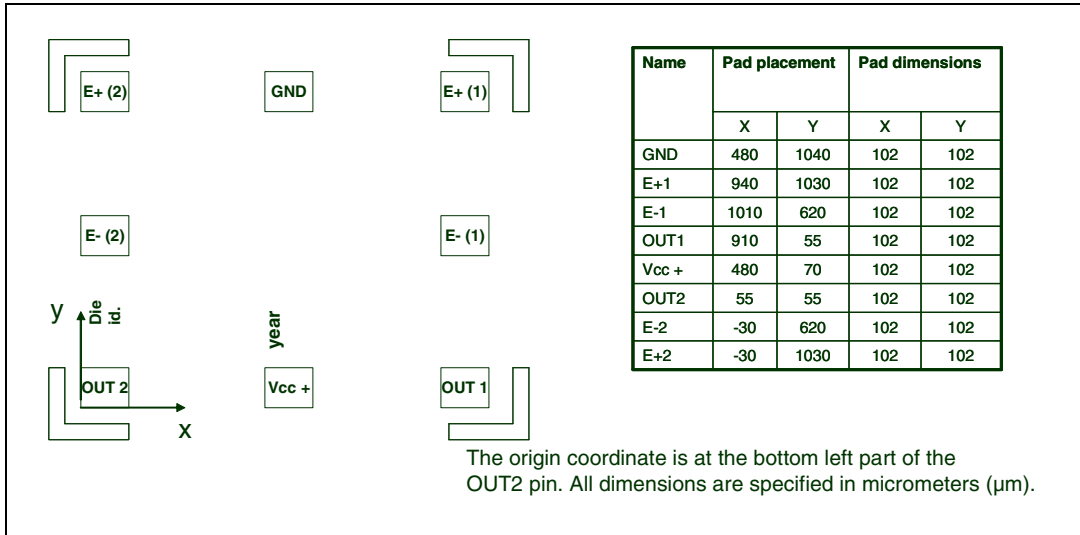

Figure 2. Pad locations



2 Absolute maximum ratings and operating conditions

Table 1. Absolute maximum ratings

Symbol	Parameter	Value	Unit
V_{CC}^+	Supply voltage	+32	V
V_{id}	Differential input voltage	-0.3 to $V_{CC}+0.3$	V
V_{in}	Input voltage	-0.3 to $V_{CC}+0.3$	V
	Output short-circuit to ground ⁽¹⁾	40	mA
T_j	Maximum junction temperature	150	°C
R_{thja}	Thermal resistance junction to ambient ⁽²⁾ SO-8	125	°C/W
R_{thjc}	Thermal resistance junction to case ⁽²⁾ SO-8	40	°C/W
I_{in}	Input current ⁽³⁾	5	mA
T_{stg}	Storage temperature range	-65 to +150	°C
ESD	HBM: human body model ⁽⁴⁾	2	kV
	MM: machine model ⁽⁵⁾	200	V
	CDM: charged device model ⁽⁶⁾	1.5	kV

- Short-circuits from the output to V_{CC} can cause excessive heating if $V_{CC}^+ > 15$ V. The maximum output current is approximately 40 mA, independent of the magnitude of V_{CC} . Destructive dissipation can result from simultaneous short-circuits on all amplifiers.
- Short-circuits can cause excessive heating and destructive dissipation. Values are typical.
- This input current only exists when the voltage values applied on the inputs is beyond the supply voltage line limits. This is not destructive if the current does not exceed 5 mA as indicated, and normal output is restored for input voltages above -0.3V.
- Human body model: A 100pF capacitor is charged to the specified voltage, then discharged through a 1.5k Ω resistor between two pins of the device. This is done for all couples of connected pin combinations while the other pins are floating.
- Machine model: A 200pF capacitor is charged to the specified voltage, then discharged directly between two pins of the device with no external series resistor (internal resistor < 5 Ω). This is done for all couples of connected pin combinations while the other pins are floating.
- Charged device model: all pins and the package are charged together to the specified voltage and then discharged directly to the ground through only one pin. This is done for all pins.

Table 2. Operating conditions

Symbol	Parameter	Value	Unit
V_{CC}^+	Supply voltage	3 to 30	V
T_{oper}	Operating free-air temperature range	-40 to +150	°C
V_{icm}	Input common mode voltage range ($V_{CC}^+=+30V$) ⁽¹⁾ $T_{amb} = 25^\circ C$ $T_{min} \leq T_{amb} \leq T_{max}$	0 to $V_{CC}^+ - 1.5$ 0 to $V_{CC}^+ - 2$	V

- The input common-mode voltage of either input signal voltage should not be allowed to go negative by more than 0.3 V. The upper end of the common-mode voltage range is $V_{CC}^+ - 1.5$ V, but either or both inputs can go to +32 V without damage.

3 Electrical characteristics

Table 3. $V_{CC}^+ = 5V$, $V_{CC}^- = \text{Ground}$, $V_O = 1.4V$, $T_{amb} = 25^\circ C$ (unless otherwise specified)

Symbol	Parameter	Min.	Typ.	Max.	Unit
V_{io}	Input offset voltage ⁽¹⁾ $T_{min} \leq T_{amb} \leq T_{max}$		2	7 9	mV
I_{io}	Input offset current $T_{min} \leq T_{amb} \leq T_{max}$		2	30 40	nA
I_{ib}	Input bias current ⁽²⁾ $T_{min} \leq T_{amb} \leq T_{max}$		20	150 200	nA
A_{vd}	Large signal voltage gain $V_{CC}^+ = +15V, R_L = 2k\Omega, V_O = 1.4V \text{ to } 11.4V$ $T_{min} \leq T_{amb} \leq T_{max}$	50 2.5	100		V/mV
SVR	Supply voltage rejection ratio $V_{CC}^+ = +5 \text{ to } +30V, R_S \leq 10k\Omega$ $T_{min} \leq T_{amb} \leq T_{max}$	65 65	100		dB
I_{CC}	Supply current, all amps, no load $V_{CC}^+ = +5V$ $T_{min} \leq T_{amb} \leq T_{max}, V_{CC} = +30V$		0.7	1.2 2	mA
CMR	Common-mode rejection ratio ($R_S = 10k\Omega$) $T_{min} \leq T_{amb} \leq T_{max}$	70 60	85		dB
I_{source}	Output short-circuit current $V_{CC}^+ = +15V, V_O = +2V, V_{id} = +1V$ $T_{min} \leq T_{amb} \leq T_{max}$	20 10	40	60	mA
I_{sink}	Output sink current $V_O = 2V, V_{CC}^+ = +5V$ $T_{min} \leq T_{amb} \leq T_{max}$ $V_O = +0.2V, V_{CC}^+ = +15V$ $T_{min} \leq T_{amb} \leq T_{max}$	10 5 12 10	20 50		mA μA
V_{OPP}	Output voltage swing ($R_L = 2k\Omega$) $T_{min} \leq T_{amb} \leq T_{max}$	0 0		$V_{CC}^+ - 1.5$ $V_{CC}^+ - 2$	V
V_{OH}	High level output voltage ($V_{CC}^+ = +30V$) $R_L = 2k\Omega$ $T_{min} \leq T_{amb} \leq T_{max}$ $R_L = 10k\Omega$ $T_{min} \leq T_{amb} \leq T_{max}$	26 26 27 27	27 28		V
V_{OL}	Low level output voltage ($R_L = 10k\Omega$) $T_{min} \leq T_{amb} \leq T_{max}$		5	20 20	mV

Table 3. $V_{CC}^+ = 5V$, $V_{CC}^- = \text{Ground}$, $V_o = 1.4V$, $T_{amb} = 25^\circ C$ (unless otherwise specified) (continued)

Symbol	Parameter	Min.	Typ.	Max.	Unit
SR	Slew rate (unity gain) $V_{CC}^+ = 15V$, $V_i = 0.5$ to $3V$, $R_L = 2k\Omega$, $C_L = 100pF$, $T_{min} \leq T_{amb} \leq T_{max}$	0.3 0.2	0.6		V/ μs
GBP	Gain bandwidth product $f = 100kHz$ $V_{CC}^+ = 30V$, $V_{in} = 10mV$, $R_L = 2k\Omega$, $C_L = 100pF$ $T_{min} \leq T_{amb} \leq T_{max}$	0.7 0.45	1.1		MHz
THD	Total harmonic distortion $f = 1kHz$, $A_V = 20dB$, $R_L = 2k\Omega$, $V_o = 2V_{pp}$, $C_L = 100pF$, $V_{CC} = 30V$		0.02		%
e_n	Equivalent input noise voltage $f = 1kHz$, $R_S = 100\Omega$, $V_{CC} = 30V$		55		nV/ \sqrt{Hz}
DV_{io}	Input offset voltage drift		7	30	$\mu V/^\circ C$
DI_{io}	Input offset current drift		10	300	pA/ $^\circ C$
V_{O1}/V_{O2}	Channel separation ⁽³⁾ $1kHz \leq f \leq 20kHz$		120		dB

- $V_o = 1.4V$, $R_S = 0\Omega$, $5V < V_{CC}^+ < 30V$, $0V < V_{ic} < V_{CC}^+ - 1.5V$.
- The direction of the input current is out of the IC. This current is essentially constant, independent of the state of the output, so there is no change in the loading charge on the input lines.
- Due to the proximity of external components, ensure that stray capacitance does not cause coupling between these external parts. Typically, this can be detected because this type of capacitance increases at higher frequencies.

Figure 3. Open loop frequency response

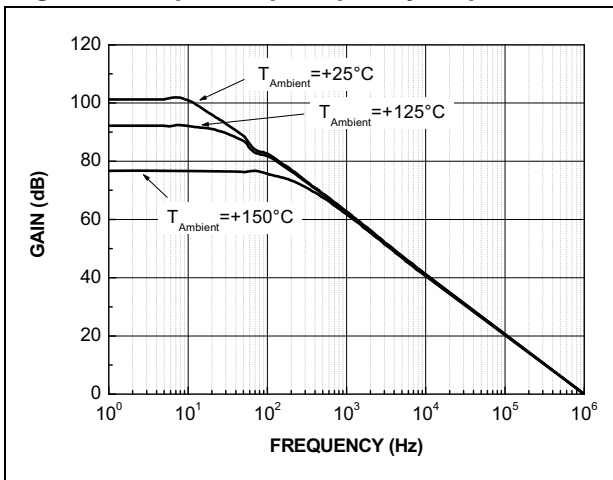

Figure 4. Large signal frequency response

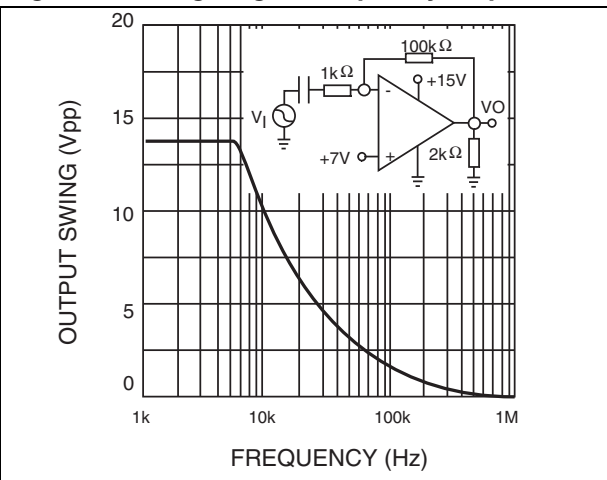

Figure 5. Voltage follower pulse response

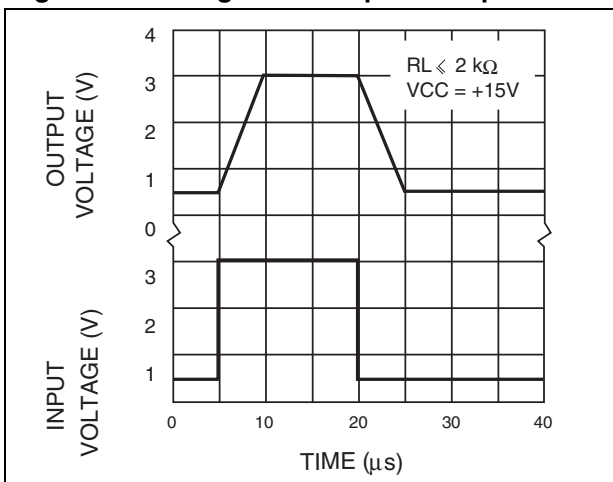

Figure 6. Input bias current

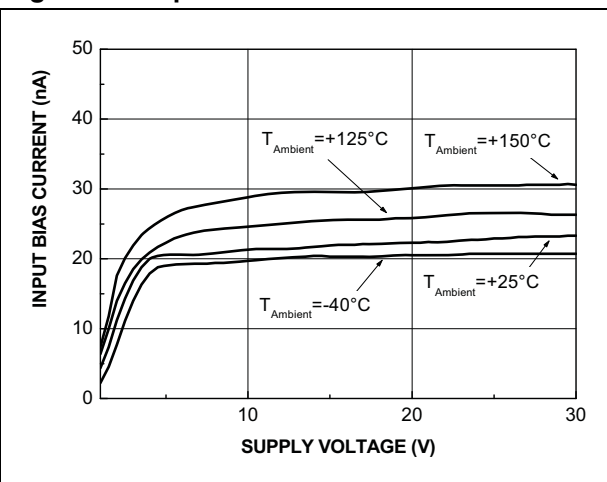

Figure 7. Supply current

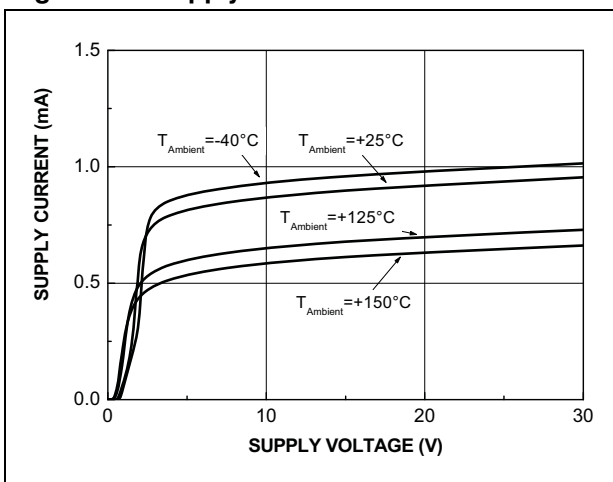

Figure 8. Output characteristics

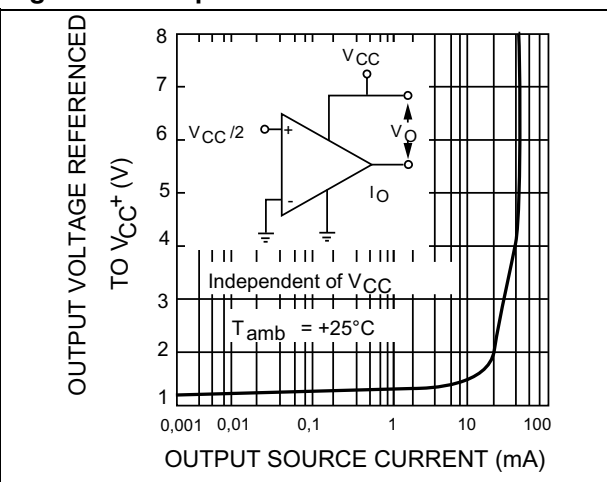

Figure 9. Output characteristics

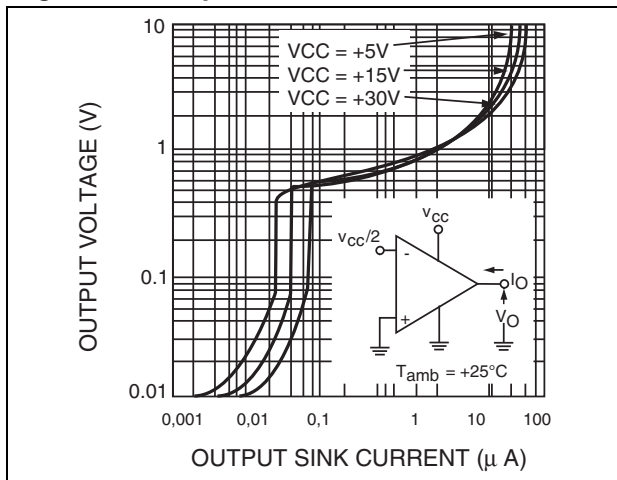

Figure 10. Current limiting

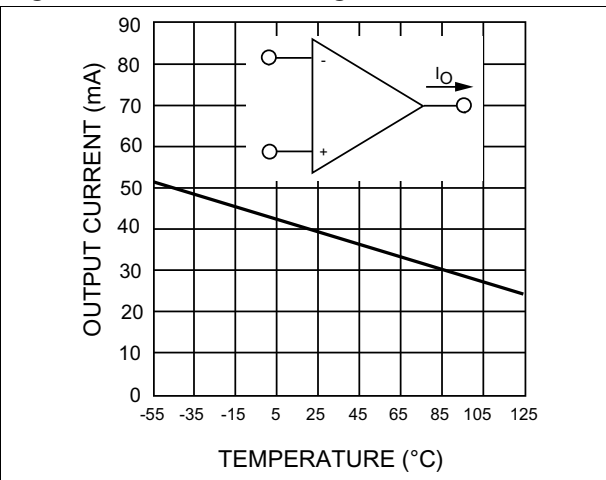

Figure 11. Voltage follower pulse response

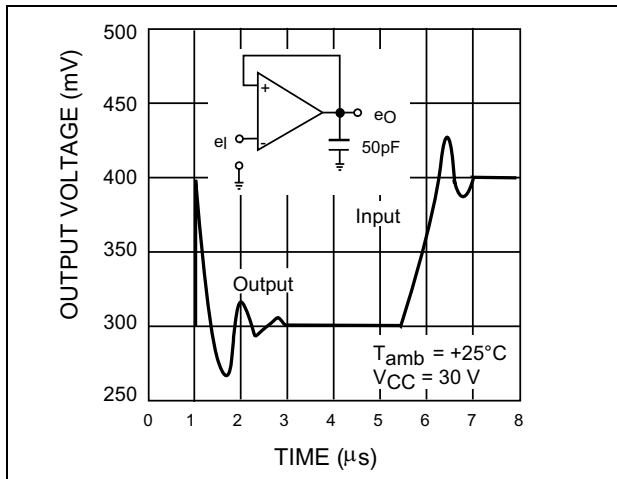

Figure 12. Input voltage range

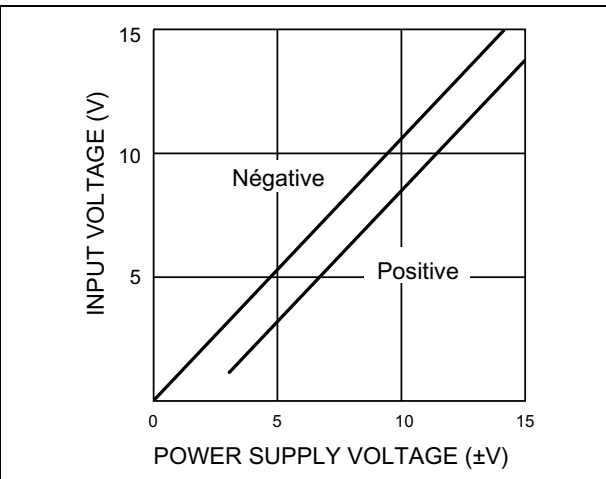

Figure 13. Voltage gain

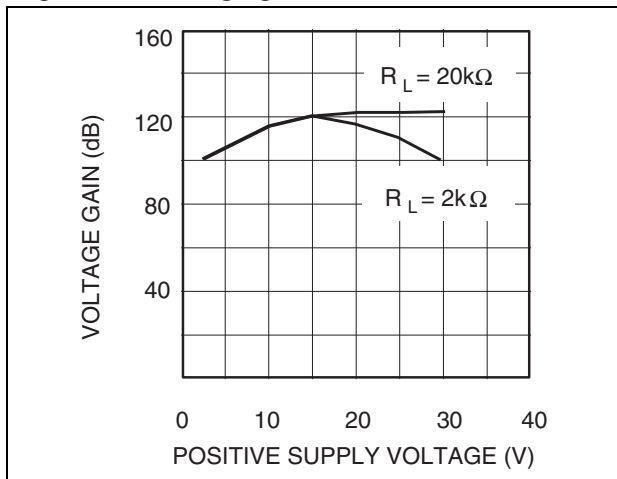

Figure 14. Gain bandwidth product

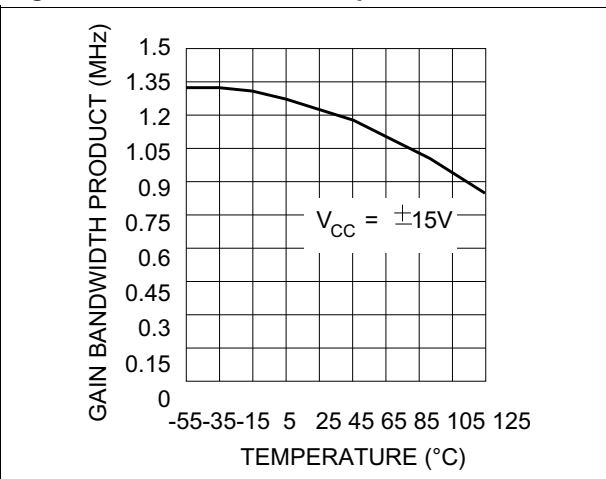

Figure 15. Power supply rejection ratio versus temperature

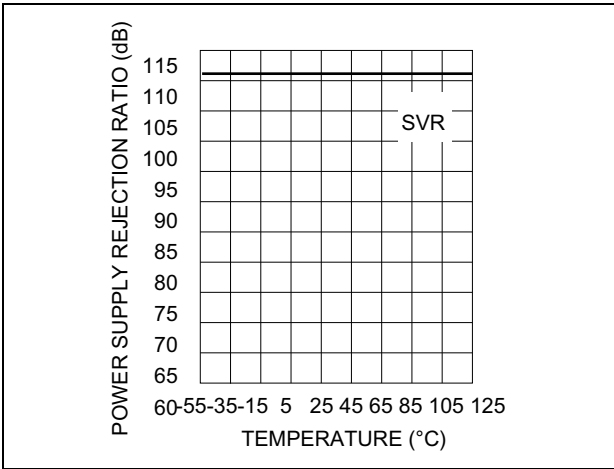
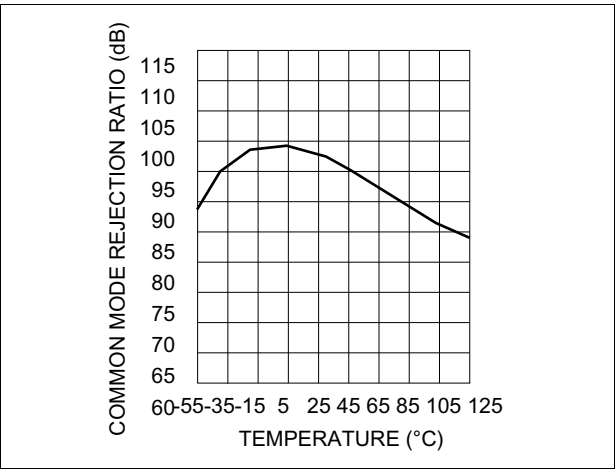

Figure 16. Common mode rejection ratio versus temperature



4 Package information

In order to meet environmental requirements, ST offers these devices in different grades of ECOPACK® packages, depending on their level of environmental compliance. ECOPACK® specifications, grade definitions and product status are available at: www.st.com. ECOPACK is an ST trademark.

Figure 17. SO-8 package mechanical drawing

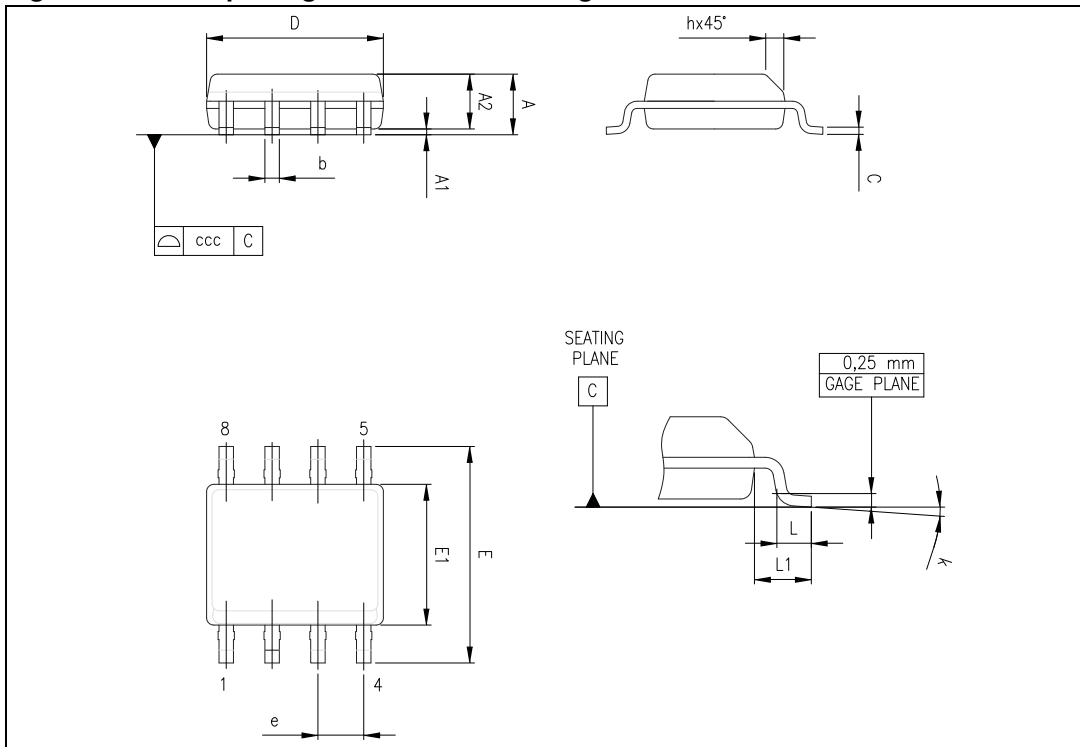

Table 4. SO-8 package mechanical data

Ref.	Dimensions					
	Millimeters			Inches		
	Min.	Typ.	Max.	Min.	Typ.	Max.
A			1.75			0.069
A1	0.10		0.25	0.004		0.010
A2	1.25			0.049		
b	0.28		0.48	0.011		0.019
c	0.17		0.23	0.007		0.010
D	4.80	4.90	5.00	0.189	0.193	0.197
E	5.80	6.00	6.20	0.228	0.236	0.244
E1	3.80	3.90	4.00	0.150	0.154	0.157
e		1.27			0.050	
h	0.25		0.50	0.010		0.020
L	0.40		1.27	0.016		0.050
k	1°		8°	1°		8°
ccc			0.10			0.004

5 Ordering information

Table 5. Order codes

Order code	Temperature range	Package	Packing	Marking
JLM2904WH-CD1	-40°C, +150°C	Wafer		
LM2904WHD LM2904WHDT		SO-8	Tube or Tape & reel	2904WH
LM2904WHYDT ⁽¹⁾		SO-8 (Automotive grade)	Tube or Tape & reel	2904WHY

1. Qualified and characterized according to AEC Q100 and Q003 or equivalent, advanced screening according to AEC Q001 & Q 002 or equivalent.

6 Revision history

Table 6. Document revision history

Date	Revision	Changes
01-Sep-2003	1	Initial release.
01-Jul-2005	2	PPAP references inserted in the datasheet, see Section 5: Ordering information .
01-Oct-2005	3	Correction of error in A_{VD} min. value in Table 3 . Minor grammatical and formatting changes throughout.
27-Sep- 2006	4	Correction of error in A_{VD} min. value in Table 3 .
20-Jul-2007	5	ESD values added in Table 1: Absolute maximum ratings . Equivalent input noise parameter added in Table 3 . Electrical characteristics curves updated. Section 4: Package information updated.
07-Apr-2008	6	Added R_{thja} and R_{thjc} parameters in Table 1: Absolute maximum ratings . Updated format of package information for SO-8. Corrected marking error in Table 5: Order codes (2904WHY, not 2904WY).
04-Jul-2012	7	Removed commercial type LM2904WHYD. Updated Table 5: Order codes .

Please Read Carefully:

Information in this document is provided solely in connection with ST products. STMicroelectronics NV and its subsidiaries ("ST") reserve the right to make changes, corrections, modifications or improvements, to this document, and the products and services described herein at any time, without notice.

All ST products are sold pursuant to ST's terms and conditions of sale.

Purchasers are solely responsible for the choice, selection and use of the ST products and services described herein, and ST assumes no liability whatsoever relating to the choice, selection or use of the ST products and services described herein.

No license, express or implied, by estoppel or otherwise, to any intellectual property rights is granted under this document. If any part of this document refers to any third party products or services it shall not be deemed a license grant by ST for the use of such third party products or services, or any intellectual property contained therein or considered as a warranty covering the use in any manner whatsoever of such third party products or services or any intellectual property contained therein.

UNLESS OTHERWISE SET FORTH IN ST'S TERMS AND CONDITIONS OF SALE ST DISCLAIMS ANY EXPRESS OR IMPLIED WARRANTY WITH RESPECT TO THE USE AND/OR SALE OF ST PRODUCTS INCLUDING WITHOUT LIMITATION IMPLIED WARRANTIES OF MERCHANTABILITY, FITNESS FOR A PARTICULAR PURPOSE (AND THEIR EQUIVALENTS UNDER THE LAWS OF ANY JURISDICTION), OR INFRINGEMENT OF ANY PATENT, COPYRIGHT OR OTHER INTELLECTUAL PROPERTY RIGHT.

UNLESS EXPRESSLY APPROVED IN WRITING BY TWO AUTHORIZED ST REPRESENTATIVES, ST PRODUCTS ARE NOT RECOMMENDED, AUTHORIZED OR WARRANTED FOR USE IN MILITARY, AIR CRAFT, SPACE, LIFE SAVING, OR LIFE SUSTAINING APPLICATIONS, NOR IN PRODUCTS OR SYSTEMS WHERE FAILURE OR MALFUNCTION MAY RESULT IN PERSONAL INJURY, DEATH, OR SEVERE PROPERTY OR ENVIRONMENTAL DAMAGE. ST PRODUCTS WHICH ARE NOT SPECIFIED AS "AUTOMOTIVE GRADE" MAY ONLY BE USED IN AUTOMOTIVE APPLICATIONS AT USER'S OWN RISK.

Resale of ST products with provisions different from the statements and/or technical features set forth in this document shall immediately void any warranty granted by ST for the ST product or service described herein and shall not create or extend in any manner whatsoever, any liability of ST.

ST and the ST logo are trademarks or registered trademarks of ST in various countries.

Information in this document supersedes and replaces all information previously supplied.

The ST logo is a registered trademark of STMicroelectronics. All other names are the property of their respective owners.

© 2012 STMicroelectronics - All rights reserved

STMicroelectronics group of companies

Australia - Belgium - Brazil - Canada - China - Czech Republic - Finland - France - Germany - Hong Kong - India - Israel - Italy - Japan - Malaysia - Malta - Morocco - Philippines - Singapore - Spain - Sweden - Switzerland - United Kingdom - United States of America

www.st.com