

ON Semiconductor

Is Now

onsemi™

To learn more about onsemi™, please visit our website at
www.onsemi.com

onsemi and **onsemi** and other names, marks, and brands are registered and/or common law trademarks of Semiconductor Components Industries, LLC dba "**onsemi**" or its affiliates and/or subsidiaries in the United States and/or other countries. **onsemi** owns the rights to a number of patents, trademarks, copyrights, trade secrets, and other intellectual property. A listing of **onsemi** product/patent coverage may be accessed at www.onsemi.com/site/pdf/Patent-Marking.pdf. **onsemi** reserves the right to make changes at any time to any products or information herein, without notice. The information herein is provided "as-is" and **onsemi** makes no warranty, representation or guarantee regarding the accuracy of the information, product features, availability, functionality, or suitability of its products for any particular purpose, nor does **onsemi** assume any liability arising out of the application or use of any product or circuit, and specifically disclaims any and all liability, including without limitation special, consequential or incidental damages. Buyer is responsible for its products and applications using **onsemi** products, including compliance with all laws, regulations and safety requirements or standards, regardless of any support or applications information provided by **onsemi**. "Typical" parameters which may be provided in **onsemi** data sheets and/or specifications can and do vary in different applications and actual performance may vary over time. All operating parameters, including "Typicals" must be validated for each customer application by customer's technical experts. **onsemi** does not convey any license under any of its intellectual property rights nor the rights of others. **onsemi** products are not designed, intended, or authorized for use as a critical component in life support systems or any FDA Class 3 medical devices or medical devices with a same or similar classification in a foreign jurisdiction or any devices intended for implantation in the human body. Should Buyer purchase or use **onsemi** products for any such unintended or unauthorized application, Buyer shall indemnify and hold **onsemi** and its officers, employees, subsidiaries, affiliates, and distributors harmless against all claims, costs, damages, and expenses, and reasonable attorney fees arising out of, directly or indirectly, any claim of personal injury or death associated with such unintended or unauthorized use, even if such claim alleges that **onsemi** was negligent regarding the design or manufacture of the part. **onsemi** is an Equal Opportunity/Affirmative Action Employer. This literature is subject to all applicable copyright laws and is not for resale in any manner. Other names and brands may be claimed as the property of others.

NCP585

Tri-Mode 300 mA CMOS LDO Regulator with Enable

The NCP585 series of low dropout regulators are designed for portable battery powered applications which require precise output voltage accuracy, low quiescent current, and high ripple rejection. These devices feature an enable function which lowers current consumption significantly and are offered in the SOT23-5 and the HSON-6 packages, in fixed output voltages between 0.8 V and 3.3 V.

This series of devices have three modes. Chip Enable (CE mode), Fast Transient Mode (FT mode), and Low Power Mode (LP mode). Both the FT and LP mode are utilized via the ECO pin.

Features

- Tri-mode Operation
- Low Dropout Voltage:
 - Typ 550 mV at 300 mA, Output Voltage = 0.9 V
 - Typ 480 mV at 300 mA, Output Voltage = 1.0 V
 - Typ 310 mV at 300 mA, Output Voltage = 1.5 V
- Excellent Line Regulation of 0.01%/V (0.05%/V LP Mode)
- Excellent Load Regulation of 15 mV (40 mV FT Mode)
- High Output Voltage Accuracy of $\pm 2\%$ ($\pm 3\%$ LP mode)
- Ultra-Low I_q Current of:
 - 3.5 μ A (LP mode, Output Voltage < 1.6 V)
 - 80 μ A (FT mode, Output Voltage < 1.8 V)
 - 60 μ A (FT mode, Output Voltage = 1.8 V)
- Very Low Shutdown Current of 0.1 μ A
- Excellent Power Supply Rejection Ratio of 70 dB at f = 1.0 kHz
- Low Temperature Drift Coefficient on the Output Voltage of ± 100 ppm/ $^{\circ}$ C
- Fold Back Protection Circuit
- Input Voltage up to 6.5 V
- These are Pb-Free Devices

Typical Applications

- Portable Equipment
- Hand-Held Instrumentation
- Camcorders and Cameras



ON Semiconductor®

<http://onsemi.com>

MARKING DIAGRAMS



SOT23-5
SN SUFFIX
CASE 1212

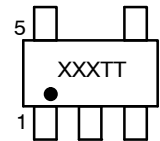

HSON-6
SAN SUFFIX
CASE 506AE

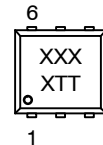

XXX = Specific Device Code
TT = Traceability Information

ORDERING INFORMATION

See detailed ordering and shipping information in the package dimensions section on page 11 of this data sheet.

*Additional voltage options may be available between 0.8 V and 3.3 V in 100 mV steps.

NCP585

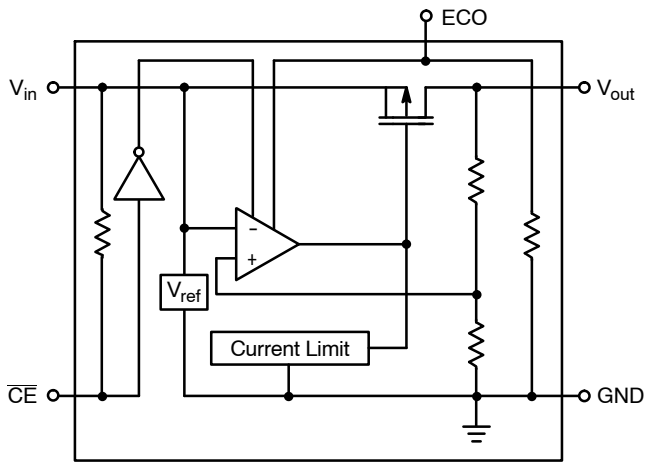

Figure 1. Simplified Block Diagram for Active Low

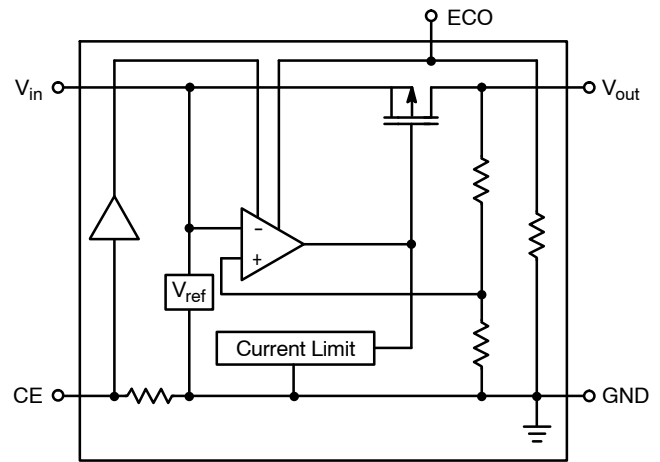

Figure 2. Simplified Block Diagram for Active High

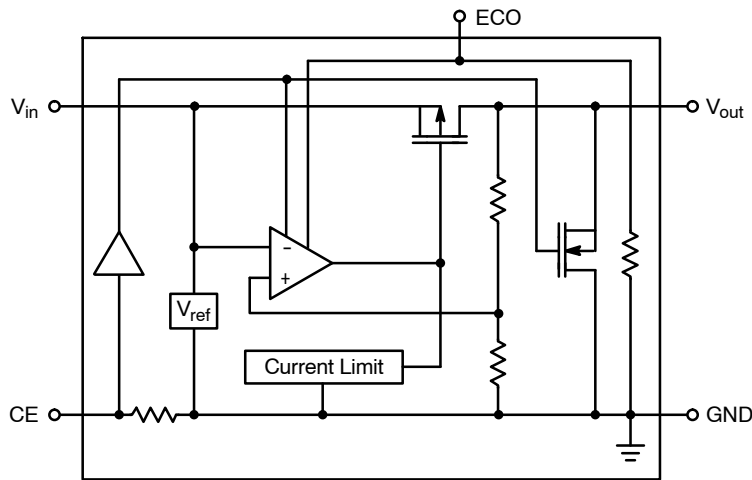

Figure 3. Simplified Block Diagram for Active High with Auto Discharge

PIN FUNCTION DESCRIPTION

| HSO-6 | SOT23-5 | Pin Name | Description |
|-------|---------|-----------------------|--|
| 1 | 1 | V_{in} | Power supply input voltage. |
| 2 | - | NC | No Connect. |
| 3 | 5 | V_{out} | Regulated output voltage. |
| 4 | 4 | ECO | Mode alternative pin. ($V_{ECO} = V_{in}$ for FT mode; $V_{ECO} = GND$ for LP mode) |
| 5 | 2 | GND | Power supply ground. |
| 6 | 3 | \overline{CE} or CE | Chip enable pin. |

NCP585

MAXIMUM RATINGS

| Rating | Symbol | Value | Unit |
|--|--------------|------------------------|-------------|
| Input Voltage | V_{in} | 6.5 | V |
| Input Voltage (\overline{CE} or CE Pin) | V_{CE} | -0.3 to 6.5 | V |
| Input Voltage (ECO Pin) | V_{ECO} | -0.3 to 6.5 | V |
| Output Voltage | V_{out} | -0.3 to $V_{in} + 0.3$ | V |
| Output Current | I_{out} | 350 | mA |
| Power Dissipation | P_D | 250 400 | mW |
| SOT23-5 HSO8-6 | | | |
| ESD Capability, Human Body Model, C = 100 pF, R = 1.5 k Ω | ESD_{HBM} | 2000 | V |
| ESD Capability, Machine Model, C = 200 pF, R = 0 Ω | ESD_{MM} | 150 | V |
| Operating Ambient Temperature Range | T_A | -40 to +85 | $^{\circ}C$ |
| Maximum Junction Temperature | $T_{J(max)}$ | 125 | $^{\circ}C$ |
| Storage Temperature Range | T_{stg} | -55 to +150 | $^{\circ}C$ |

Stresses exceeding Maximum Ratings may damage the device. Maximum Ratings are stress ratings only. Functional operation above the Recommended Operating Conditions is not implied. Extended exposure to stresses above the Recommended Operating Conditions may affect device reliability.

ELECTRICAL CHARACTERISTICS ($V_{in} = V_{out} + 1.0$ V, $T_A = 25^{\circ}C$, unless otherwise noted.)

| Characteristic | Symbol | Min | Typ | Max | Unit | | |
|--|----------------------------------|--|---|--|---|--|---|
| Input Voltage | V_{in} | 1.4 | - | 6.0 | V | | |
| Output Voltage ($1.0 \mu A \leq I_{out} \leq 30$ mA) $V_{ECO} = V_{in}$ $V_{ECO} = GND$ | V_{out} | $V_{out} \times 0.980$ $V_{out} \times 0.970$ | - - | $V_{out} \times 1.020$ $V_{out} \times 1.030$ | V | | |
| Line Regulation ($I_{out} = 30$ mA, $V_{out} + 0.5$ V $\leq V_{in} \leq 6.0$ V) FT Mode $V_{ECO} = V_{in}$ LP Mode $V_{ECO} = GND$ | Reg_{line} | - - | 0.01 0.05 | 0.15 0.20 | %/V | | |
| Load Regulation FT Mode (1.0 mA $\leq I_{out} \leq 300$ mA), $V_{ECO} = V_{in}$ LP Mode (1.0 mA $\leq I_{out} \leq 100$ mA), $V_{ECO} = GND$ | Reg_{load} | - - | 40 15 | 70 30 | mV | | |
| Dropout Voltage ($I_{out} = 300$ mA) $V_{out} = 0.9$ V 1.0 V $\leq V_{out} \leq 1.25$ V 1.5 V $\leq V_{out} \leq 2.5$ V 2.8 V $\leq V_{out} \leq 3.3$ V | V_{DO} | - - - - | ECO = H 0.55 0.48 0.31 0.23 | ECO = L 0.59 0.51 0.32 0.24 | ECO = H 0.78 0.70 0.45 0.35 | ECO = L 0.80 0.75 0.48 0.375 | V |
| Quiescent Current ($I_{out} = 0$ mA) FT Mode, $V_{ECO} = V_{in}$ $V_{out} < 1.8$ V $V_{out} \geq 1.8$ V LP Mode, $V_{ECO} = GND$ $V_{out} < 1.6$ V $V_{out} \geq 1.8$ V | I_q | - - - - | 80 60 3.5 4.5 | 111 90 8.0 9.0 | μA | | |
| Output Current ($V_{in} - V_{out} = 1.0$ V) | I_{out} | 300 | - | - | mA | | |
| Shutdown Current ($V_{CE} = V_{in}$) | I_{SD} | - | 0.1 | 1.0 | μA | | |
| Output Short Circuit Current ($V_{out} = 0$ V) | I_{lim} | - | 50 | - | mA | | |
| Enable Input Threshold Voltage - High - Low | $V_{th_{enh}}$ $V_{th_{enl}}$ | 1.0 0.0 | - - | V_{in} 0.3 | V | | |
| Output Noise Voltage (10 Hz - 100 kHz) | V_n | - | 30 | - | μV_{rms} | | |
| N-Channel On Resistance for Auto Discharge | R_{Low} | - | 60 | - | Ω | | |
| Ripple Rejection ($I_{out} = 50$ mA, $V_{out} = 0.9$ V, $V_{in} - V_{out} = 1.0$ V) $f = 120$ Hz $f = 1.0$ kHz $f = 10$ kHz | RR | - - - | 75 70 65 | - - - | dB | | |
| Output Voltage Temperature Coefficient ($I_{out} = 30$ mA, $-40^{\circ}C \leq T_A \leq 85^{\circ}C$) | $\Delta V_{out}/\Delta T$ | - | ± 100 | - | ppm/ $^{\circ}C$ | | |

TYPICAL CHARACTERISTICS

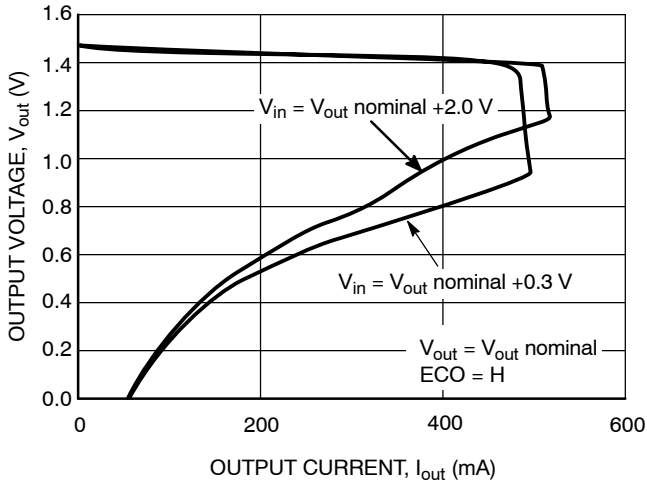

Figure 4. Output Voltage vs. Output Current

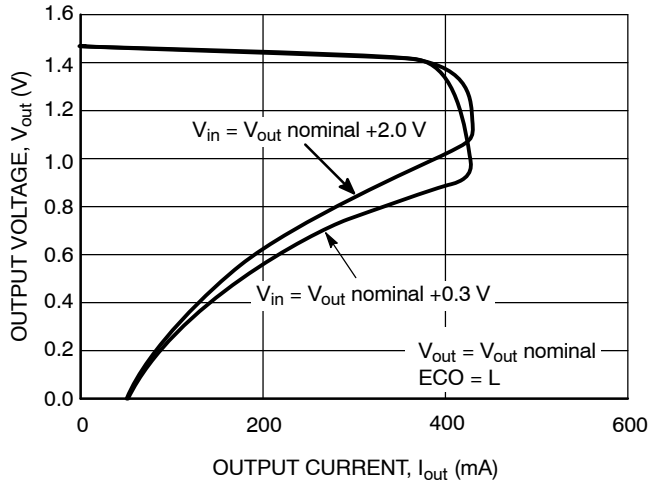

Figure 5. Output Voltage vs. Output Current

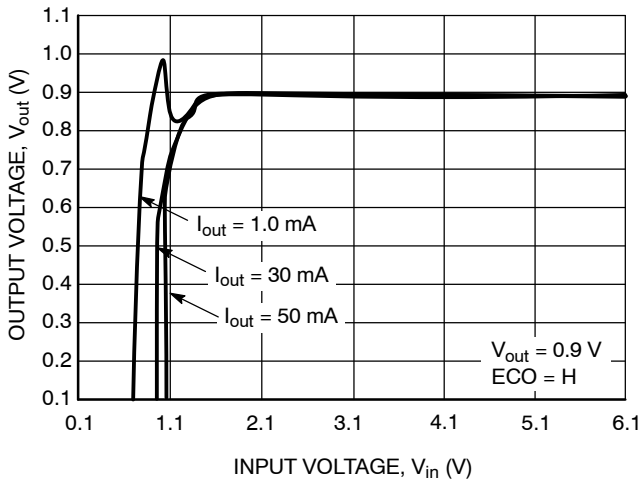

Figure 6. Output Voltage vs. Input Voltage

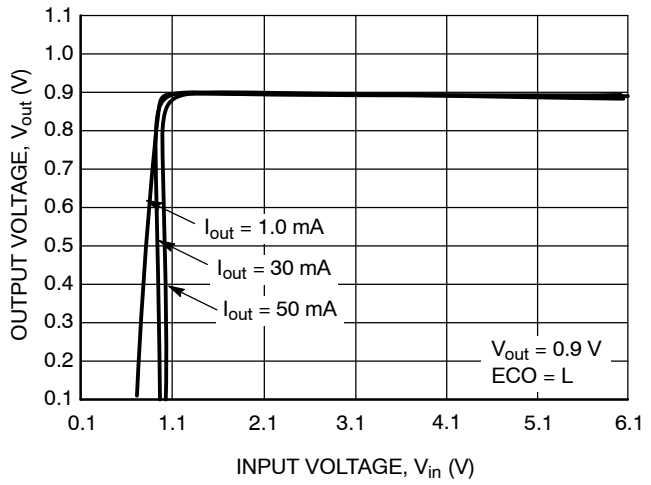

Figure 7. Output Voltage vs. Input Voltage

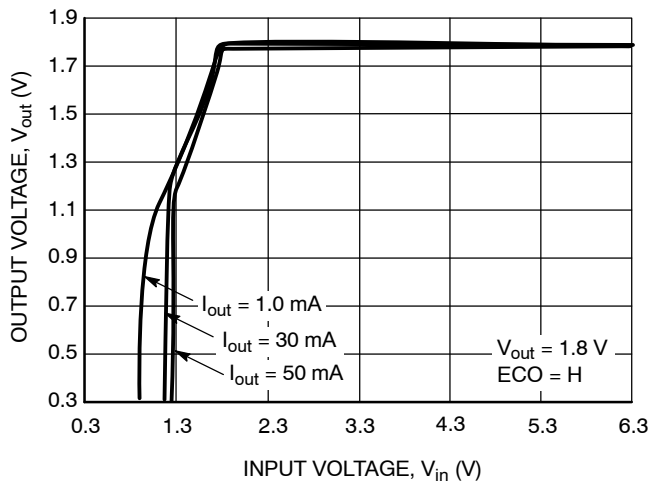

Figure 8. Output Voltage vs. Input Voltage

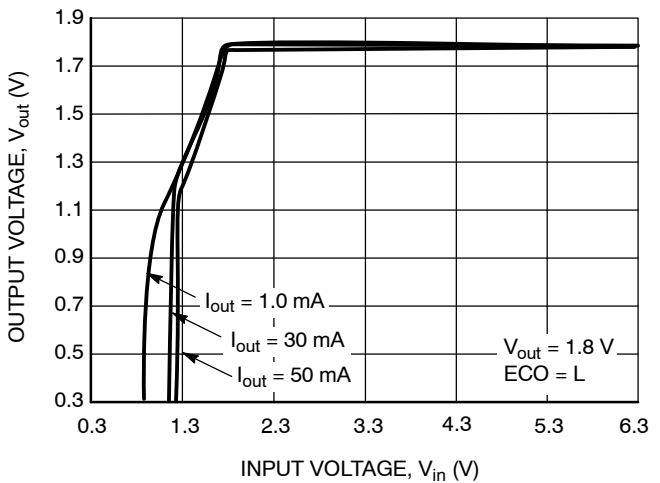

Figure 9. Output Voltage vs. Input Voltage

TYPICAL CHARACTERISTICS

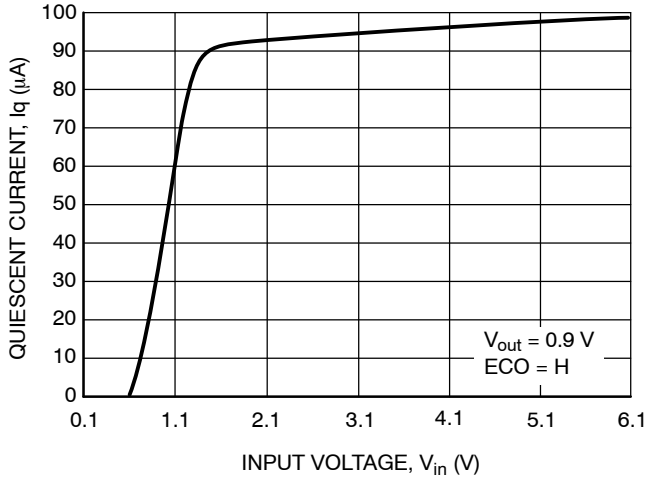

Figure 10. Quiescent Current vs. Input Voltage

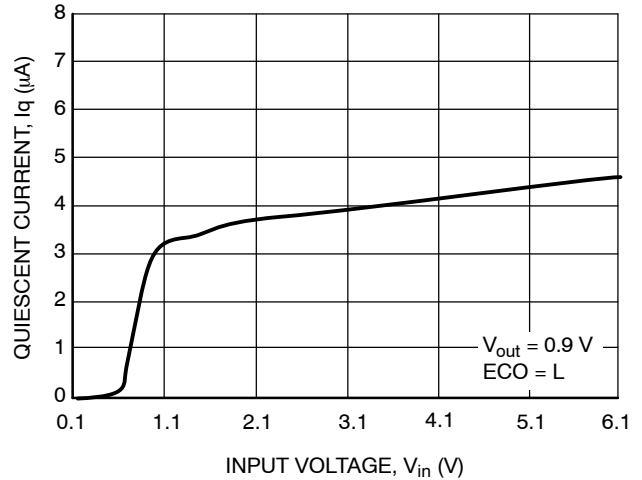

Figure 11. Quiescent Current vs. Input Voltage

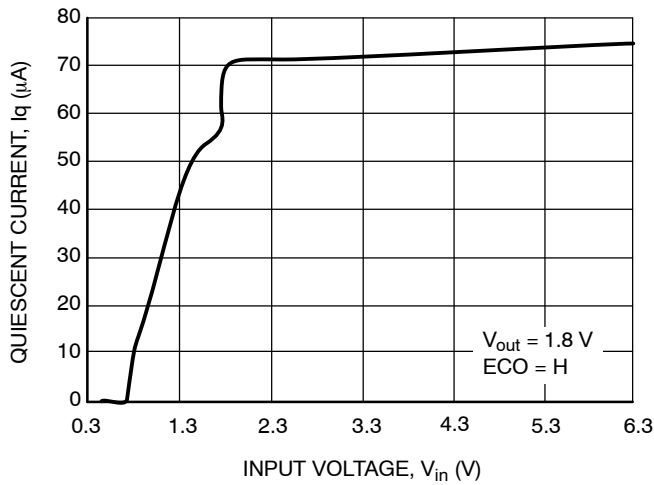

Figure 12. Quiescent Current vs. Input Voltage

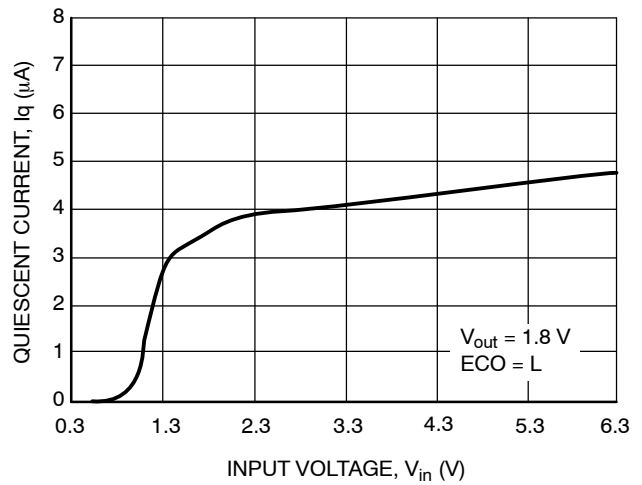

Figure 13. Quiescent Current vs. Input Voltage

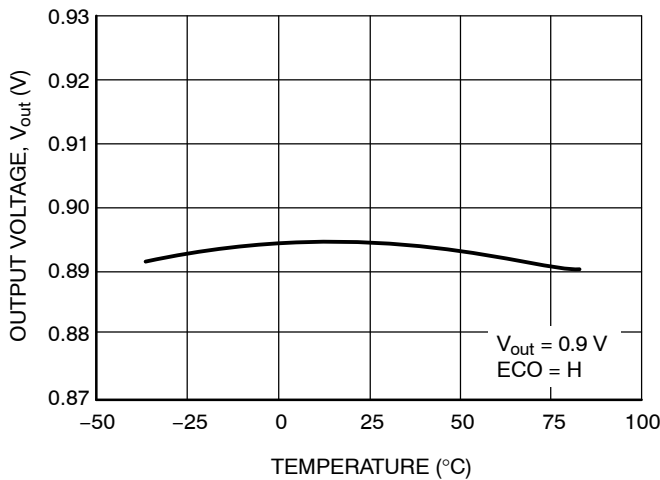

Figure 14. Output Voltage vs. Temperature

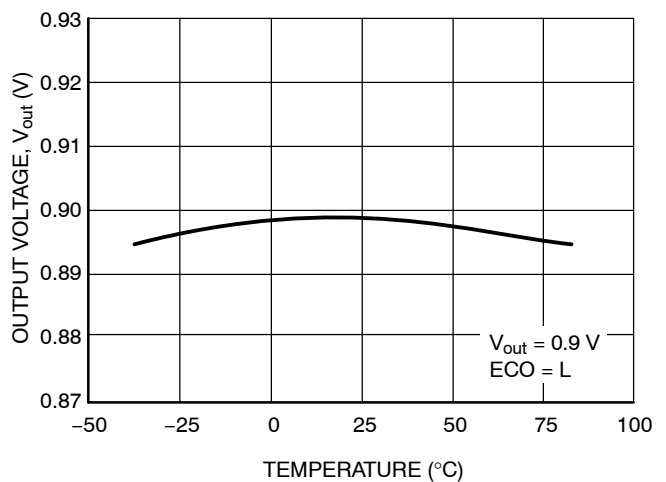

Figure 15. Output Voltage vs. Temperature

TYPICAL CHARACTERISTICS

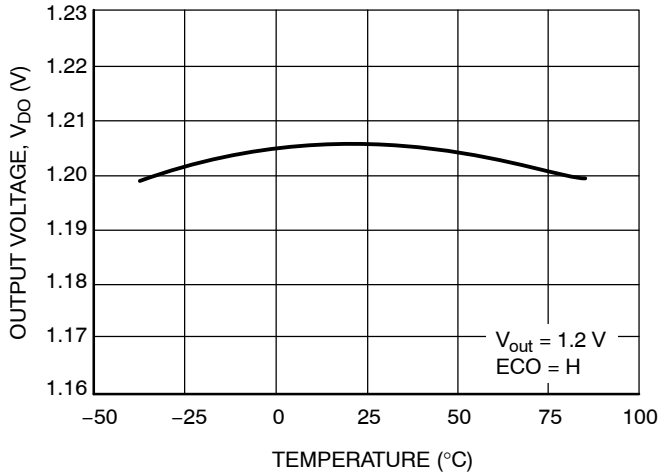

Figure 16. Output Voltage vs. Temperature

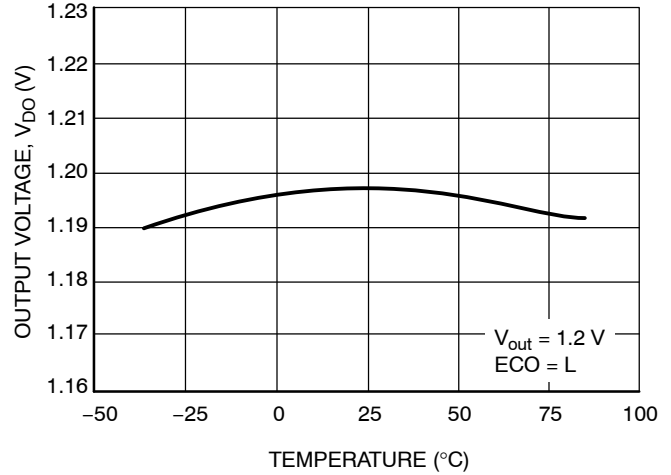

Figure 17. Output Voltage vs. Temperature

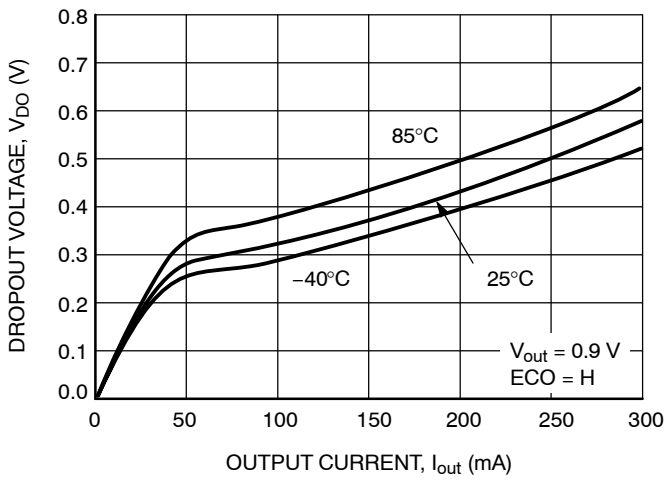

Figure 18. Dropout Voltage vs. Output Current

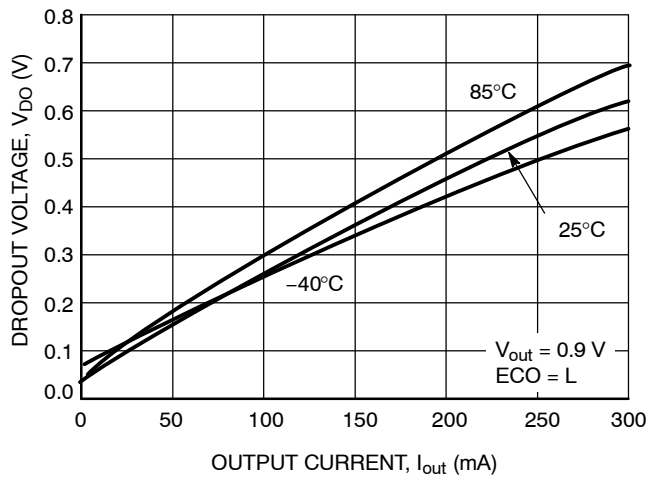

Figure 19. Dropout Voltage vs. Output Current

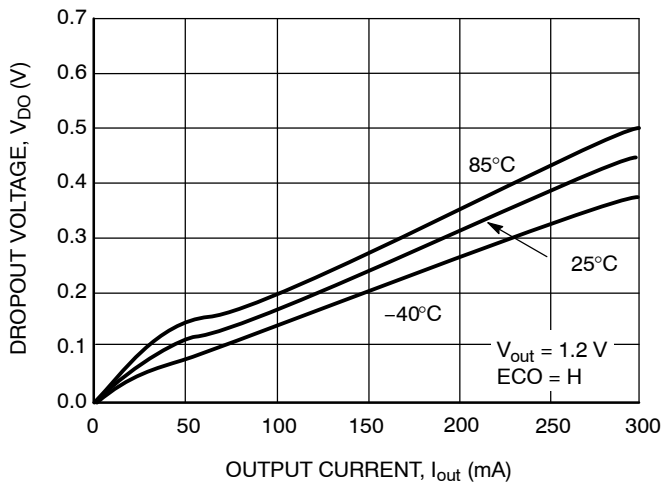

Figure 20. Dropout Voltage vs. Output Current

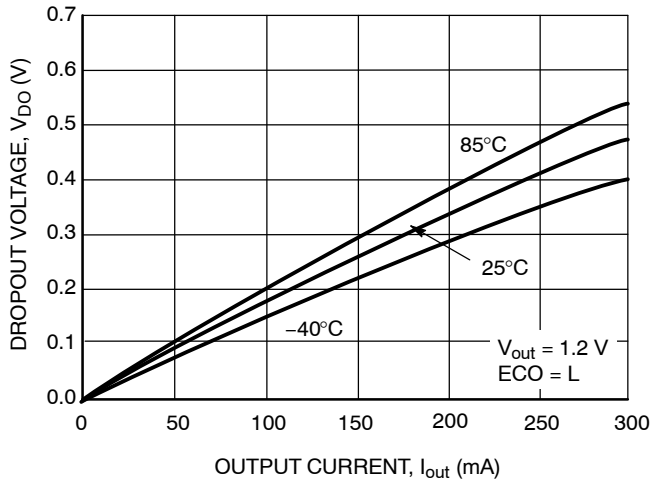

Figure 21. Dropout Voltage vs. Output Current

TYPICAL CHARACTERISTICS

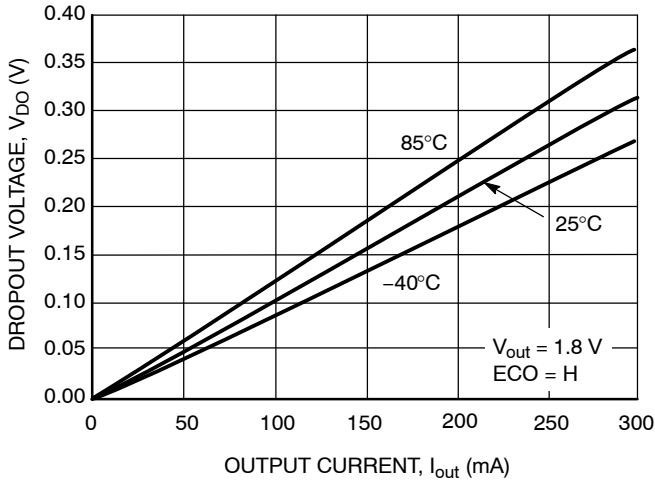

Figure 22. Dropout Voltage vs. Output Current

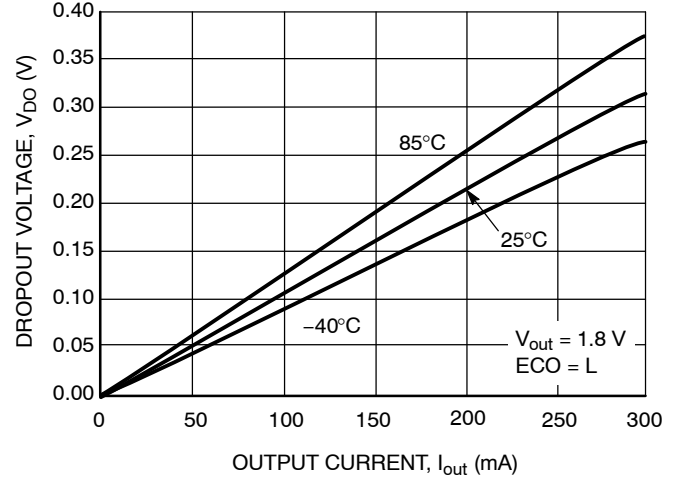

Figure 23. Dropout Voltage vs. Output Current

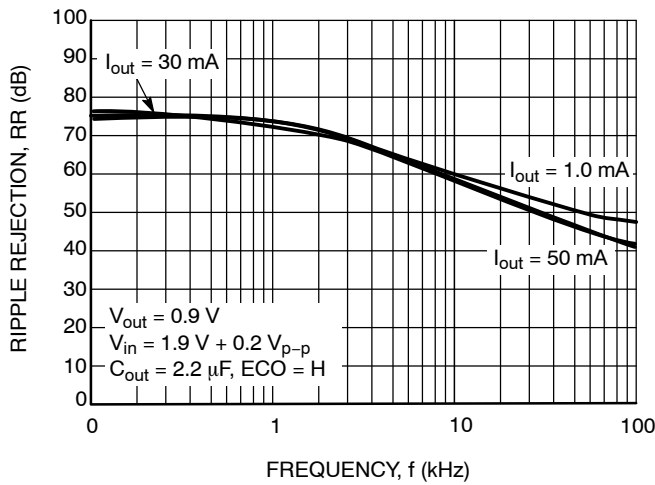

Figure 24. Ripple Rejection vs. Frequency

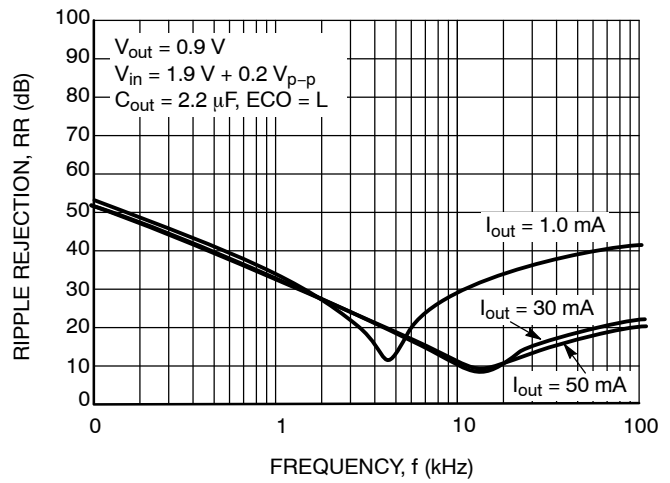

Figure 25. Ripple Rejection vs. Frequency

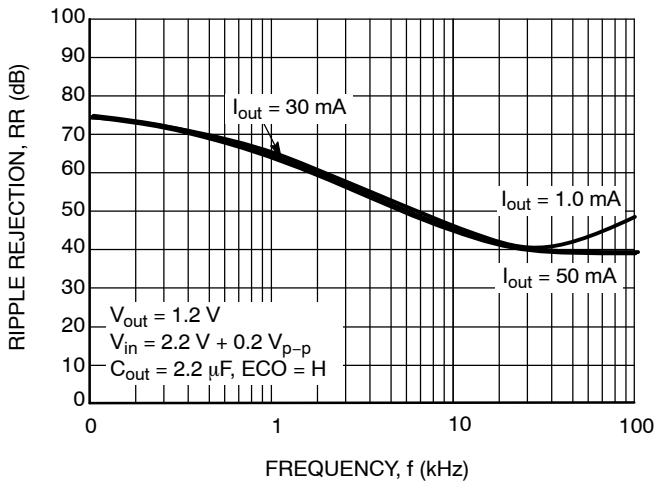

Figure 26. Ripple Rejection vs. Frequency

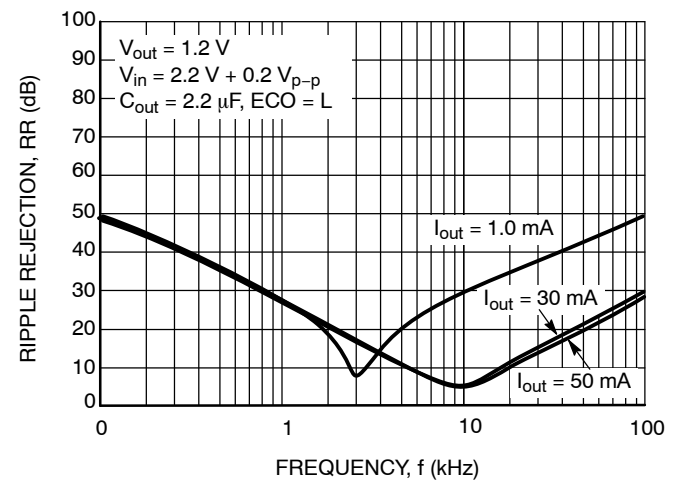

Figure 27. Ripple Rejection vs. Frequency

TYPICAL CHARACTERISTICS

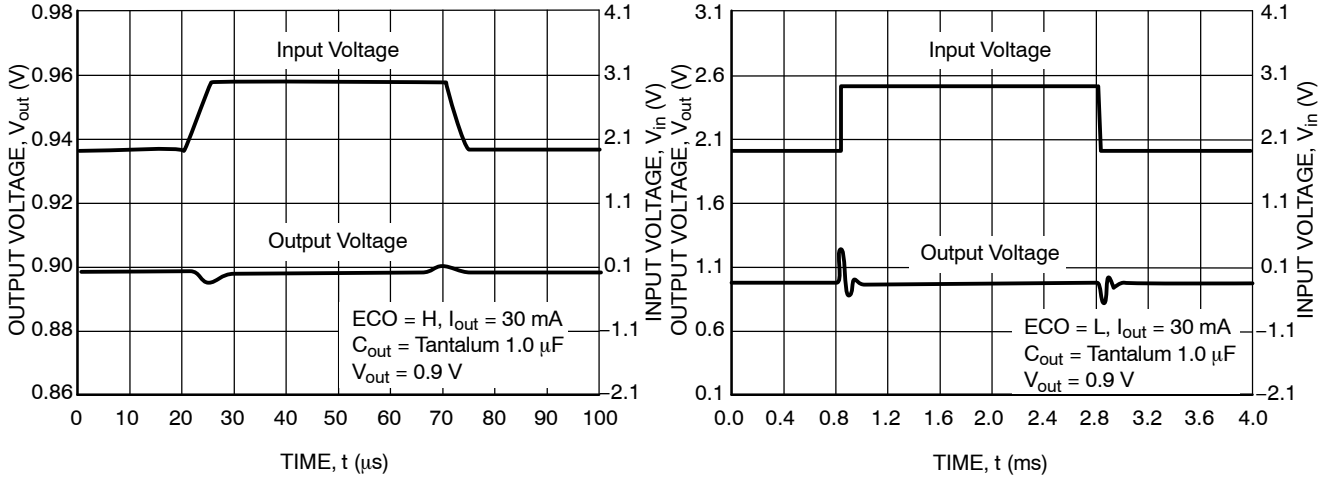

Figure 28. Input Transient Response

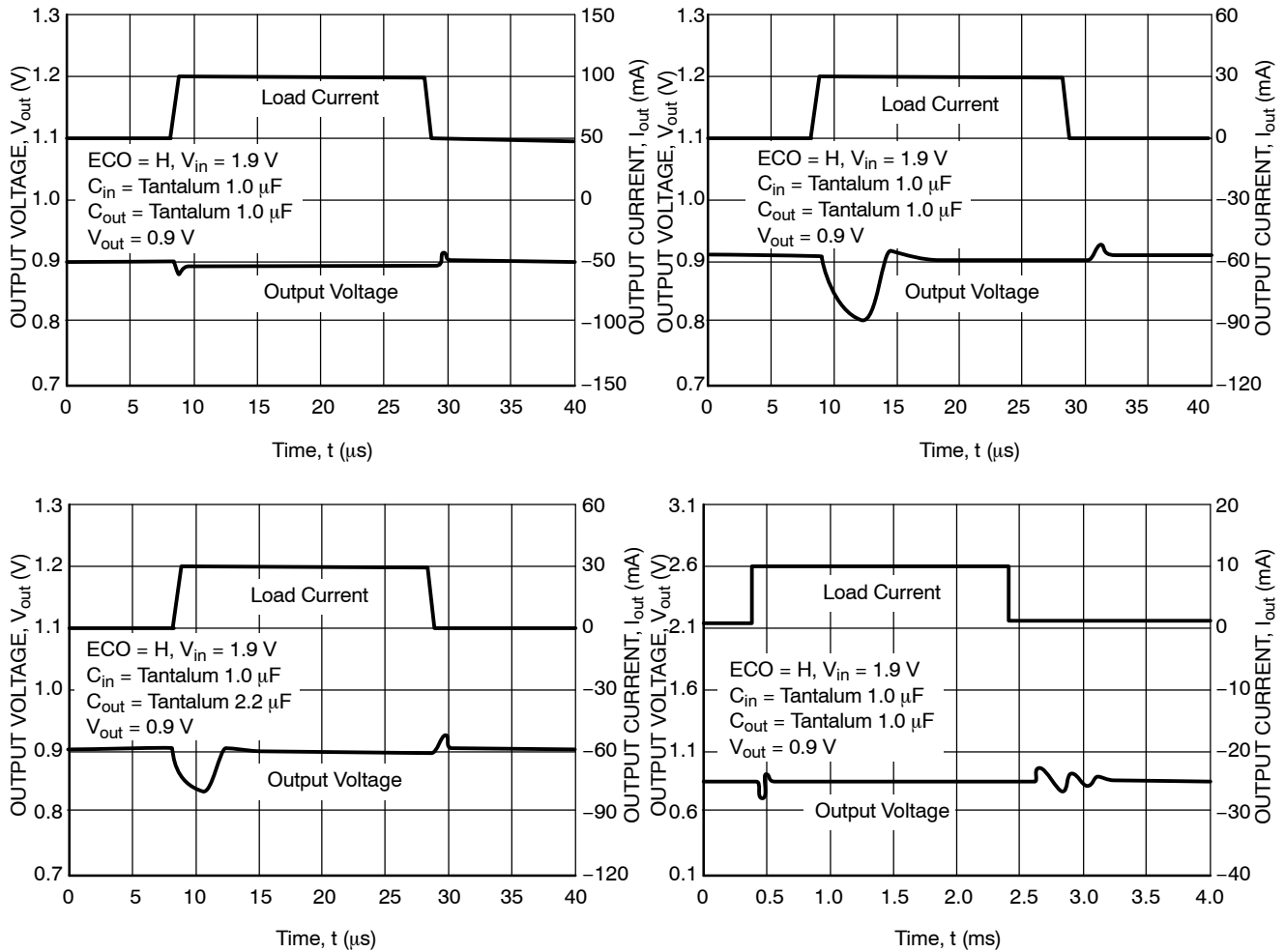

Figure 29. Load Transient Response

NCP585

TYPICAL CHARACTERISTICS

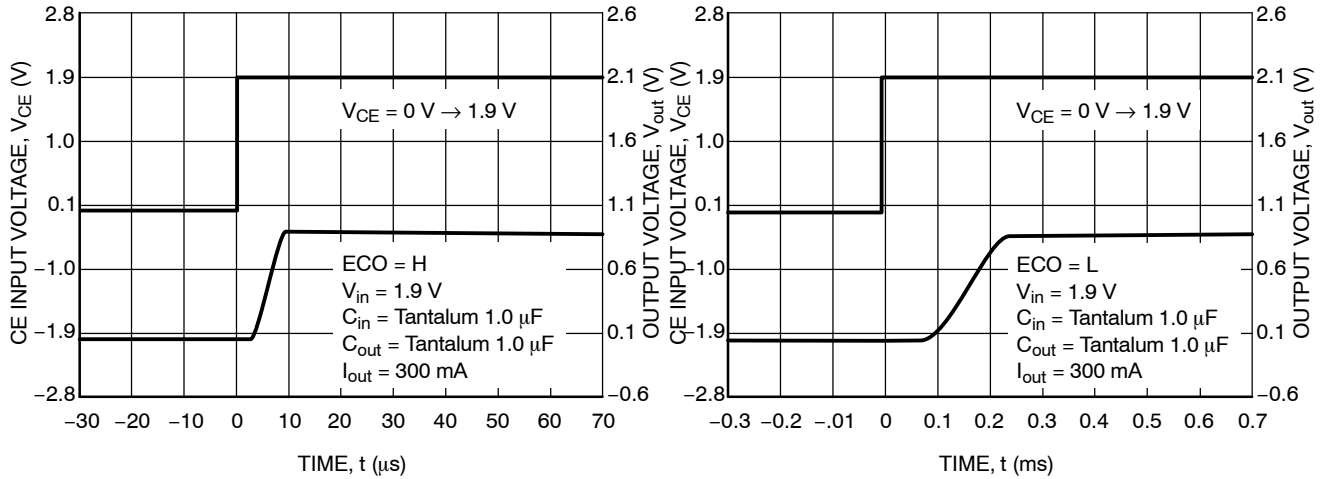

Figure 30. Turn-On Speed with CE Pin, V_{out} = 0.8 V

V_{in} = 1.9 V, C_{in} = Tantalum 1.0 μF, C_{out} = Tantalum 1.0 μF, V_{out} = 0.9 V

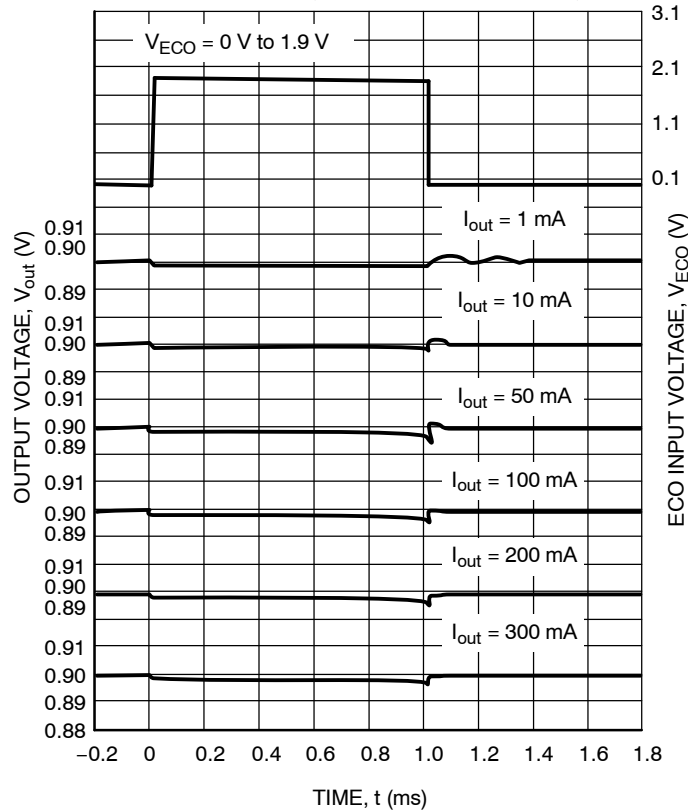

Figure 31. Output Voltage at Mode Alternative Point

TYPICAL CHARACTERISTICS

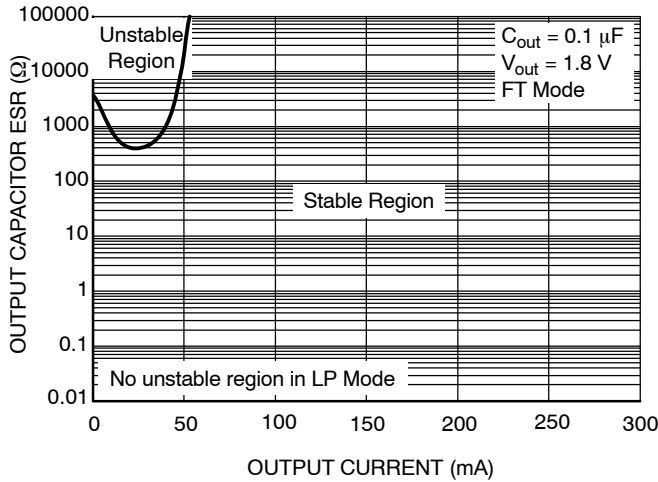

Figure 32. Output Stability, Output Capacitor ESR vs. Output Load Current (0.1 μF)

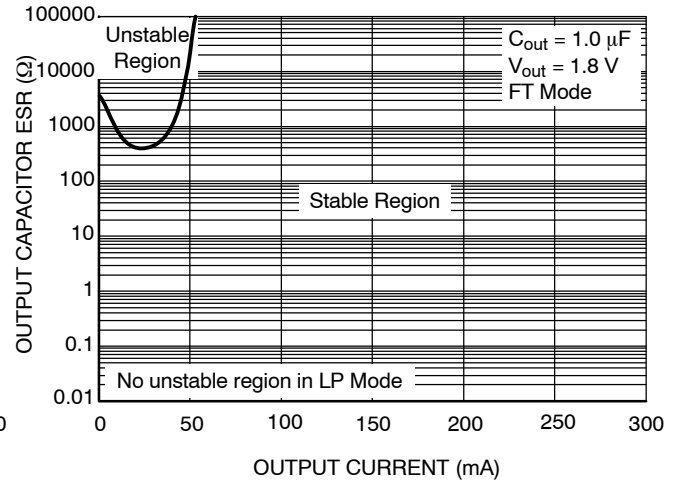

Figure 33. Output Stability, Output Capacitor ESR vs. Output Load Current (1.0 μF)

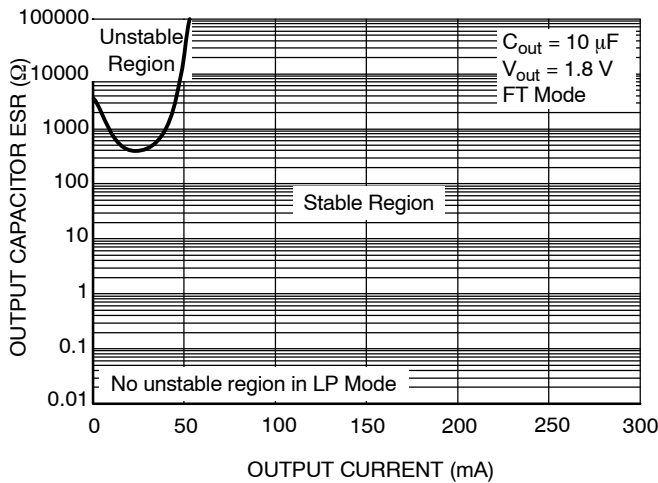

Figure 34. Output Stability, Output Capacitor ESR vs. Output Load Current (10 μF)

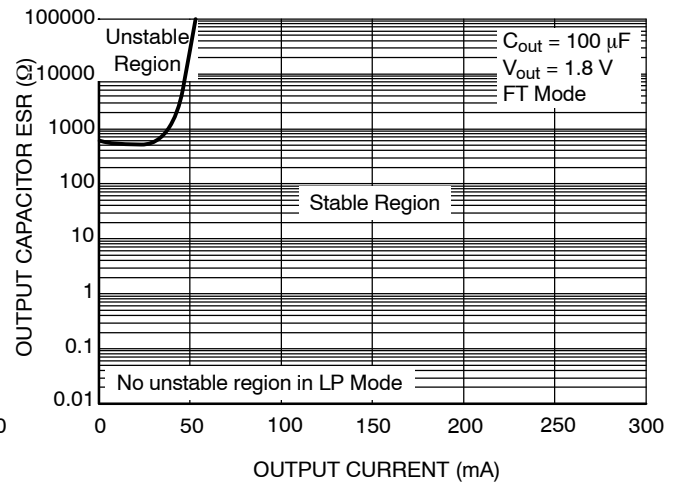

Figure 35. Output Stability, Output Capacitor ESR vs. Output Load Current (100 μF)

APPLICATION INFORMATION

Input Decoupling

A 1.0 μF ceramic capacitor is the recommended value to be connected between V_{in} and GND. For PCB layout considerations, the traces on V_{in} and GND should be sufficiently wide in order to minimize noise and prevent unstable operation.

Output Decoupling

It is best to use a 1.0 μF capacitor value on the V_{out} pin. For better performance, select a capacitor with low Equivalent Series Resistance (ESR). For PCB layout considerations, place the output capacitor close to the output pin and keep the leads short as possible.

NCP585

ORDERING INFORMATION

| Device | Output Type / Features | Nominal Output Voltage | Marking | Package | Shipping [†] |
|-----------------|--|------------------------|---------|-------------------|-----------------------|
| NCP585DSAN09T1G | Active High w/Auto Discharge, LP and FT Mode | 0.9 | B09D | HSO-6 (Pb-Free) | 3000 Tape & Reel |
| NCP585DSAN12T1G | Active High w/Auto Discharge, LP and FT Mode | 1.2 | B12D | HSO-6 (Pb-Free) | 3000 Tape & Reel |
| NCP585DSAN18T1G | Active High w/Auto Discharge, LP and FT Mode | 1.8 | B18D | HSO-6 (Pb-Free) | 3000 Tape & Reel |
| NCP585DSN09T1G | Active High w/Auto Discharge, LP and FT Mode | 0.9 | R09 | SOT23-5 (Pb-Free) | 3000 Tape & Reel |
| NCP585DSN12T1G | Active High w/Auto Discharge, LP and FT Mode | 1.2 | R12 | SOT23-5 (Pb-Free) | 3000 Tape & Reel |
| NCP585DSN125T1G | Active High w/Auto Discharge, LP and FT Mode | 1.25 | R01 | SOT23-5 (Pb-Free) | 3000 Tape & Reel |
| NCP585DSN15T1G | Active High w/Auto Discharge, LP and FT Mode | 1.5 | R15 | SOT23-5 (Pb-Free) | 3000 Tape & Reel |
| NCP585DSN18T1G | Active High w/Auto Discharge, LP and FT Mode | 1.8 | R18 | SOT23-5 (Pb-Free) | 3000 Tape & Reel |
| NCP585DSN25T1G | Active High w/Auto Discharge, LP and FT Mode | 2.5 | R25 | SOT23-5 (Pb-Free) | 3000 Tape & Reel |
| NCP585DSN28T1G | Active High w/Auto Discharge, LP and FT Mode | 2.8 | R28 | SOT23-5 (Pb-Free) | 3000 Tape & Reel |
| NCP585DSN30T1G | Active High w/Auto Discharge, LP and FT Mode | 3.0 | R30 | SOT23-5 (Pb-Free) | 3000 Tape & Reel |
| NCP585DSN33T1G | Active High w/Auto Discharge, LP and FT Mode | 3.3 | R33 | SOT23-5 (Pb-Free) | 3000 Tape & Reel |
| NCP585HSAN09T1G | Active High, LP and FT Mode | 0.9 | B09B | HSO-6 (Pb-Free) | 3000 Tape & Reel |
| NCP585HSAN12T1G | Active High, LP and FT Mode | 1.2 | B12B | HSO-6 (Pb-Free) | 3000 Tape & Reel |
| NCP585HSAN18T1G | Active High, LP and FT Mode | 1.8 | B18B | HSO-6 (Pb-Free) | 3000 Tape & Reel |
| NCP585HSN09T1G | Active High, LP and FT Mode | 0.9 | Q09 | SOT23-5 (Pb-Free) | 3000 Tape & Reel |
| NCP585HSN10T1G | Active High, LP and FT Mode | 1.0 | Q10 | SOT23-5 (Pb-Free) | 3000 Tape & Reel |
| NCP585HSN12T1G | Active High, LP and FT Mode | 1.2 | Q12 | SOT23-5 (Pb-Free) | 3000 Tape & Reel |
| NCP585HSN18T1G | Active High, LP and FT Mode | 1.8 | Q18 | SOT23-5 (Pb-Free) | 3000 Tape & Reel |
| NCP585HSN30T1G | Active High, LP and FT Mode | 3.0 | Q30 | SOT23-5 (Pb-Free) | 3000 Tape & Reel |
| NCP585LSAN09T1G | Active Low, LP and FT Mode | 0.9 | B09A | HSO-6 (Pb-Free) | 3000 Tape & Reel |
| NCP585LSAN12T1G | Active Low, LP and FT Mode | 1.2 | B12A | HSO-6 (Pb-Free) | 3000 Tape & Reel |
| NCP585LSAN18T1G | Active Low, LP and FT Mode | 1.8 | B18A | HSO-6 (Pb-Free) | 3000 Tape & Reel |
| NCP585LSN09T1G | Active Low, LP and FT Mode | 0.9 | P09 | SOT23-5 (Pb-Free) | 3000 Tape & Reel |
| NCP585LSN12T1G | Active Low, LP and FT Mode | 1.2 | P12 | SOT23-5 (Pb-Free) | 3000 Tape & Reel |
| NCP585LSN18T1G | Active Low, LP and FT Mode | 1.8 | P18 | SOT23-5 (Pb-Free) | 3000 Tape & Reel |

[†] For information on tape and reel specifications, including part orientation and tape sizes, please refer to our Tape and Reel Packaging Specification Brochure, BRD8011/D.

Other voltages are available. Consult your ON Semiconductor representative.

MECHANICAL CASE OUTLINE

PACKAGE DIMENSIONS

ON Semiconductor®



SCALE 2:1

SOT-23 5-LEAD CASE 1212-01 ISSUE A

DATE 28 JAN 2011

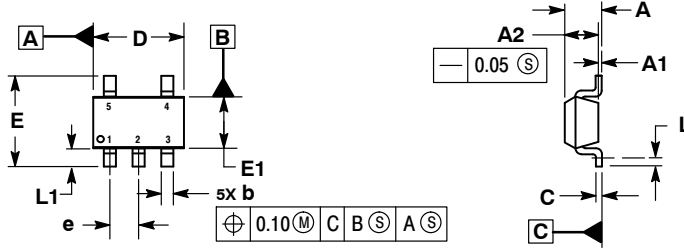

NOTES:

1. DIMENSIONING AND TOLERANCING PER ASME Y14.5M, 1994.
2. CONTROLLING DIMENSIONS: MILLIMETERS.
3. DATUM C IS THE SEATING PLANE.

| MILLIMETERS | | |
|-------------|----------|------|
| DIM | MIN | MAX |
| A | --- | 1.45 |
| A1 | 0.00 | 0.10 |
| A2 | 1.00 | 1.30 |
| b | 0.30 | 0.50 |
| c | 0.10 | 0.25 |
| D | 2.70 | 3.10 |
| E | 2.50 | 3.10 |
| E1 | 1.50 | 1.80 |
| e | 0.95 BSC | |
| L | 0.20 | --- |
| L1 | 0.45 | 0.75 |

RECOMMENDED SOLDERING FOOTPRINT*

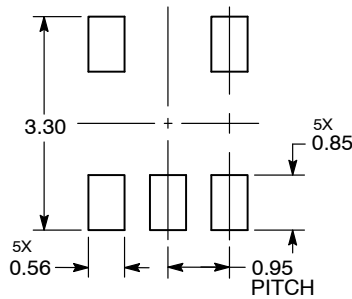

DIMENSIONS: MILLIMETERS

*For additional information on our Pb-Free strategy and soldering details, please download the ON Semiconductor Soldering and Mounting Techniques Reference Manual, SOLDERRM/D.

GENERIC MARKING DIAGRAM*

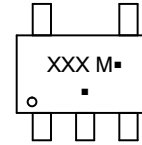

XXX = Specific Device Code

M = Date Code

▪ = Pb-Free Package

(Note: Microdot may be in either location)

*This information is generic. Please refer to device data sheet for actual part marking. Pb-Free indicator, "G" or microdot "▪", may or may not be present.

| | | |
|-------------------------|----------------------|--|
| DOCUMENT NUMBER: | 98ASH70518A | Electronic versions are uncontrolled except when accessed directly from the Document Repository. Printed versions are uncontrolled except when stamped "CONTROLLED COPY" in red. |
| DESCRIPTION: | SOT-23 5-LEAD | PAGE 1 OF 1 |

ON Semiconductor and are trademarks of Semiconductor Components Industries, LLC dba ON Semiconductor or its subsidiaries in the United States and/or other countries. ON Semiconductor reserves the right to make changes without further notice to any products herein. ON Semiconductor makes no warranty, representation or guarantee regarding the suitability of its products for any particular purpose, nor does ON Semiconductor assume any liability arising out of the application or use of any product or circuit, and specifically disclaims any and all liability, including without limitation special, consequential or incidental damages. ON Semiconductor does not convey any license under its patent rights nor the rights of others.

MECHANICAL CASE OUTLINE

PACKAGE DIMENSIONS

ON Semiconductor®



SCALE 2:1

HSO_N-6
CASE 506AE-01
ISSUE A

DATE 26 JAN 2005

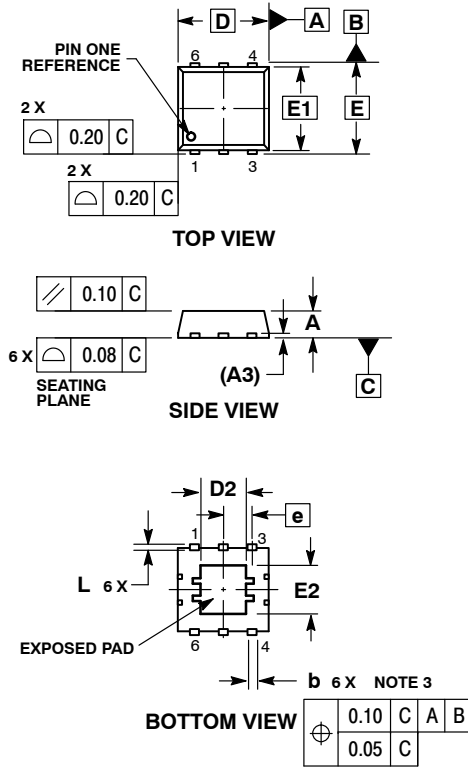

NOTES:

1. DIMENSIONING AND TOLERANCING PER ASME Y14.5M, 1994.
2. CONTROLLING DIMENSION: MILLIMETERS.
3. DIMENSION b APPLIES TO PLATED TERMINAL AND IS MEASURED BETWEEN 0.10 AND 0.15 MM FROM TERMINAL.
4. COPLANARITY APPLIES TO THE EXPOSED PAD AS WELL AS THE TERMINALS.

| DIM | MILLIMETERS | |
|-----|-------------|------|
| | MIN | MAX |
| A | 0.70 | 0.90 |
| A3 | 0.15 REF | |
| b | 0.20 | 0.40 |
| D | 2.90 BSC | |
| D2 | 1.40 | 1.60 |
| E | 3.00 BSC | |
| E1 | 2.80 BSC | |
| E2 | 1.50 | 1.70 |
| e | 0.95 BSC | |
| L | 0.15 | 0.25 |

GENERIC MARKING DIAGRAM*

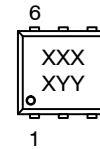

XXXX = Specific Device Code
YY = Wafer Lot

*This information is generic. Please refer to device data sheet for actual part marking. Pb-Free indicator, "G" or microdot "▪", may or may not be present.

| | | |
|-------------------------|---|--|
| DOCUMENT NUMBER: | 98AON19447D | Electronic versions are uncontrolled except when accessed directly from the Document Repository. Printed versions are uncontrolled except when stamped "CONTROLLED COPY" in red. |
| DESCRIPTION: | HSO_N-6, 2.9 X 3.0 MM, 0.95 MM PITCH | PAGE 1 OF 1 |

ON Semiconductor and are trademarks of Semiconductor Components Industries, LLC dba ON Semiconductor or its subsidiaries in the United States and/or other countries. ON Semiconductor reserves the right to make changes without further notice to any products herein. ON Semiconductor makes no warranty, representation or guarantee regarding the suitability of its products for any particular purpose, nor does ON Semiconductor assume any liability arising out of the application or use of any product or circuit, and specifically disclaims any and all liability, including without limitation special, consequential or incidental damages. ON Semiconductor does not convey any license under its patent rights nor the rights of others.

ON Semiconductor and  are trademarks of Semiconductor Components Industries, LLC dba ON Semiconductor or its subsidiaries in the United States and/or other countries. ON Semiconductor owns the rights to a number of patents, trademarks, copyrights, trade secrets, and other intellectual property. A listing of ON Semiconductor's product/patent coverage may be accessed at www.onsemi.com/site/pdf/Patent-Marking.pdf. ON Semiconductor reserves the right to make changes without further notice to any products herein. ON Semiconductor makes no warranty, representation or guarantee regarding the suitability of its products for any particular purpose, nor does ON Semiconductor assume any liability arising out of the application or use of any product or circuit, and specifically disclaims any and all liability, including without limitation special, consequential or incidental damages. Buyer is responsible for its products and applications using ON Semiconductor products, including compliance with all laws, regulations and safety requirements or standards, regardless of any support or applications information provided by ON Semiconductor. "Typical" parameters which may be provided in ON Semiconductor data sheets and/or specifications can and do vary in different applications and actual performance may vary over time. All operating parameters, including "Typicals" must be validated for each customer application by customer's technical experts. ON Semiconductor does not convey any license under its patent rights nor the rights of others. ON Semiconductor products are not designed, intended, or authorized for use as a critical component in life support systems or any FDA Class 3 medical devices or medical devices with a same or similar classification in a foreign jurisdiction or any devices intended for implantation in the human body. Should Buyer purchase or use ON Semiconductor products for any such unintended or unauthorized application, Buyer shall indemnify and hold ON Semiconductor and its officers, employees, subsidiaries, affiliates, and distributors harmless against all claims, costs, damages, and expenses, and reasonable attorney fees arising out of, directly or indirectly, any claim of personal injury or death associated with such unintended or unauthorized use, even if such claim alleges that ON Semiconductor was negligent regarding the design or manufacture of the part. ON Semiconductor is an Equal Opportunity/Affirmative Action Employer. This literature is subject to all applicable copyright laws and is not for resale in any manner.

PUBLICATION ORDERING INFORMATION

LITERATURE FULFILLMENT:

Email Requests to: orderlit@onsemi.com

ON Semiconductor Website: www.onsemi.com

TECHNICAL SUPPORT

North American Technical Support:
Voice Mail: 1 800-282-9855 Toll Free USA/Canada
Phone: 011 421 33 790 2910

Europe, Middle East and Africa Technical Support:

Phone: 00421 33 790 2910

For additional information, please contact your local Sales Representative

