

# ON Semiconductor

## Is Now

# onsemi™

To learn more about onsemi™, please visit our website at  
[www.onsemi.com](http://www.onsemi.com)

**onsemi** and **onsemi** and other names, marks, and brands are registered and/or common law trademarks of Semiconductor Components Industries, LLC dba "**onsemi**" or its affiliates and/or subsidiaries in the United States and/or other countries. **onsemi** owns the rights to a number of patents, trademarks, copyrights, trade secrets, and other intellectual property. A listing of **onsemi** product/patent coverage may be accessed at [www.onsemi.com/site/pdf/Patent-Marking.pdf](http://www.onsemi.com/site/pdf/Patent-Marking.pdf). **onsemi** reserves the right to make changes at any time to any products or information herein, without notice. The information herein is provided "as-is" and **onsemi** makes no warranty, representation or guarantee regarding the accuracy of the information, product features, availability, functionality, or suitability of its products for any particular purpose, nor does **onsemi** assume any liability arising out of the application or use of any product or circuit, and specifically disclaims any and all liability, including without limitation special, consequential or incidental damages. Buyer is responsible for its products and applications using **onsemi** products, including compliance with all laws, regulations and safety requirements or standards, regardless of any support or applications information provided by **onsemi**. "Typical" parameters which may be provided in **onsemi** data sheets and/or specifications can and do vary in different applications and actual performance may vary over time. All operating parameters, including "Typicals" must be validated for each customer application by customer's technical experts. **onsemi** does not convey any license under any of its intellectual property rights nor the rights of others. **onsemi** products are not designed, intended, or authorized for use as a critical component in life support systems or any FDA Class 3 medical devices or medical devices with a same or similar classification in a foreign jurisdiction or any devices intended for implantation in the human body. Should Buyer purchase or use **onsemi** products for any such unintended or unauthorized application, Buyer shall indemnify and hold **onsemi** and its officers, employees, subsidiaries, affiliates, and distributors harmless against all claims, costs, damages, and expenses, and reasonable attorney fees arising out of, directly or indirectly, any claim of personal injury or death associated with such unintended or unauthorized use, even if such claim alleges that **onsemi** was negligent regarding the design or manufacture of the part. **onsemi** is an Equal Opportunity/Affirmative Action Employer. This literature is subject to all applicable copyright laws and is not for resale in any manner. Other names and brands may be claimed as the property of others.

# NCP4623

## 150 mA, Wide Input Voltage Range, Low Dropout Regulator

The NCP4623 is a CMOS Linear Voltage Regulator designed for wide input voltage range. The maximum operating input voltage is up to 24 V with a minimum voltage starting from 2 V. The Chip Enable (CE) pin allows the device to lower standby current to 0.1  $\mu$ A typ. The NCP4623 features many protections for any current or thermal sensitive devices with current fold-back protection, thermal shutdown protection, and peak and short current protection. This device is available in adjustable and fixed voltage output in 0.1 V steps. They are available in very thin XDFN6 1.6x1.6x0.4 mm in size and the very popular SOT23-5 and SOT89-5 packages. Please contact your local sales office for additional output voltage options.

### Features

- Maximum Operating Input Voltage: 24 V
- Output Voltage Range: 2.5 V to 12.0 V (available in 0.1 V steps)  
2.5 V to 24.0 V (adjustable version)
- Output Voltage Accuracy:  $\pm 2.0\%$
- Supply Current: 5  $\mu$ A
- Stable with Ceramic Capacitors: 1  $\mu$ F or more
- Current Fold Back Protection
- Peak and Short Current Protection
- Thermal Shutdown Protection
- Available in XDFN6 1.6 x 1.6 mm, SOT23-5, SOT89-5 Packages
- These are Pb-Free Devices

### Typical Applications

- Battery-powered Equipment
- Networking and Communication Equipment
- Cameras, DVRs, STB and Camcorders
- Home Appliances

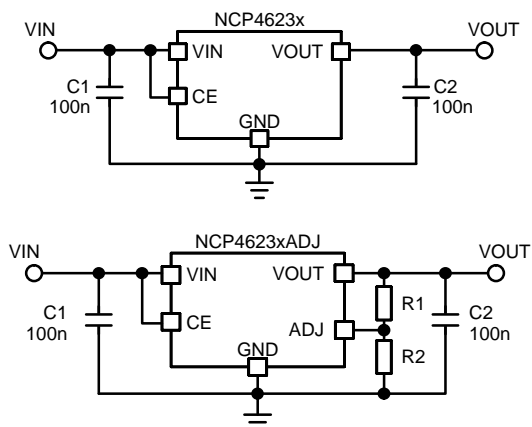

Figure 1. Typical Application Schematics



ON Semiconductor™

[www.onsemi.com](http://www.onsemi.com)

### MARKING DIAGRAMS

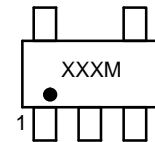
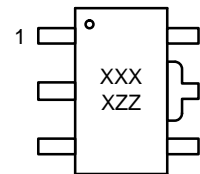
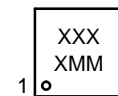

XXX, XXXX = Specific Device Code  
M, MM = Date Code  
ZZ = Lot Code

### ORDERING INFORMATION

See detailed ordering and shipping information in the package dimensions section on page 17 of this data sheet.

# NCP4623

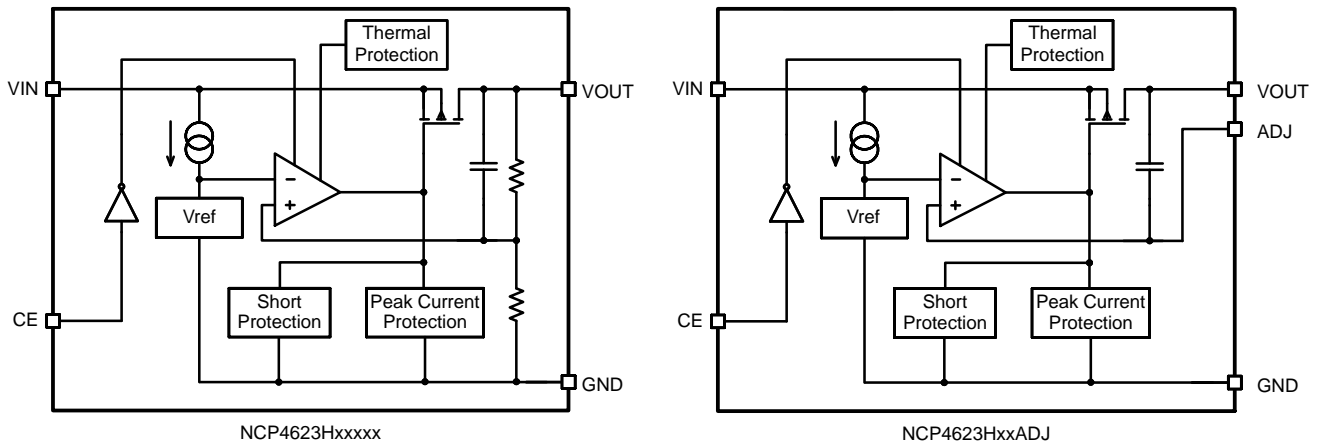

Figure 2. Simplified Schematic Block Diagram

## PIN FUNCTION DESCRIPTION

Pin No. XDFN (Note 1)	Pin No. SOT89-5	Pin No. SOT23	Pin Name	Description
3	1	1	V <sub>OUT</sub>	Output pin
6	2	2	GND	Ground
4	3	5	CE	Chip enable pin (Active "H")
1	5	3	V <sub>IN</sub>	Input pin
5	4	4	NC/ADJ	No connection (non ADJ versions) / Reference Voltage of Adjustable Output Pin (ADJ versions)
2	-	-	NC	No connection

1. Tab is connected to GND. Tab should be connected to GND, but leaving it unconnected is also acceptable

# NCP4623

## ABSOLUTE MAXIMUM RATINGS

Rating	Symbol	Value	Unit
Input Voltage (Note 2)	$V_{IN}$	26.0	V
Output Voltage	$V_{OUT}$	-0.3 to $V_{IN} + 0.3$	V
Chip Enable Input	$V_{CE}$	-0.3 to $V_{IN} + 0.3$	V
Reference Input Voltage	$V_{ADJ}$	-0.3 to $V_{IN} + 0.3$	V
Output Current	$I_{OUT}$	250	mA
Power Dissipation XDFN6-1616	$P_D$	640	mW
Power Dissipation SOT89-5		900	
Power Dissipation SOT23-5		420	
Junction Temperature	$T_J$	-40 to 150	°C
Operation Temperature	$T_A$	-40 to 85	°C
Storage Temperature	$T_{STG}$	-55 to 125	°C
ESD Capability, Human Body Model (Note 3)	$ESD_{HBM}$	2000	V
ESD Capability, Machine Model (Note 3)	$ESD_{MM}$	200	V

Stresses exceeding those listed in the Maximum Ratings table may damage the device. If any of these limits are exceeded, device functionality should not be assumed, damage may occur and reliability may be affected.

2. Refer to ELECTRICAL CHARACTERISTICS and APPLICATION INFORMATION for Safe Operating Area.

3. This device series incorporates ESD protection and is tested by the following methods:

ESD Human Body Model tested per AEC-Q100-002 (EIA/JESD22-A114)

ESD Machine Model tested per AEC-Q100-003 (EIA/JESD22-A115)

Latchup Current Maximum Rating tested per JEDEC standard: JESD78.

Latchup Current Maximum Rating tested per JEDEC standard: JESD78.

## THERMAL CHARACTERISTICS

Rating	Symbol	Value	Unit
Thermal Characteristics, XDFN6 Thermal Resistance, Junction-to-Air	$R_{\theta JA}$	156	°C/W
Thermal Characteristics, SOT23-5 Thermal Resistance, Junction-to-Air	$R_{\theta JA}$	238	°C/W
Thermal Characteristics, SOT89-5 Thermal Resistance, Junction-to-Air	$R_{\theta JA}$	111	°C/W

## ELECTRICAL CHARACTERISTICS NCP4623Hxxxx, $C_{IN} = C_{OUT} = 0.1 \mu F$ , $T_A = +25^\circ C$

Parameter	Test Conditions	Symbol	Min	Typ	Max	Unit	
Operating Input Voltage		$V_{IN}$	2		24	V	
Output Voltage	$V_{IN} = V_{OUT(NOM)} + 2.0 V$ , $I_{OUT} = 20 mA$	$V_{OUT}$	x0.98		x1.02	V	
Output Voltage Temp. Coefficient	$V_{IN} = V_{OUT(NOM)} + 2.0 V$ , $I_{OUT} = 20 mA$ , $-40^\circ C \leq T_A \leq 105^\circ C$	$\Delta V_{OUT}/\Delta T_A$		±100		ppm/°C	
Line Regulation	$V_{OUT(NOM)} + 1 V \leq V_{IN} \leq 24 V$ , $I_{OUT} = 20 mA$	$Line_{Reg}$		0.05	0.20	%/V	
Load Regulation	$V_{IN} = V_{OUT(NOM)} + 2.0 V$ , $I_{OUT} = 1 mA$ to 40 mA	$Load_{Reg}$	$2.5 V \leq V_{OUT} \leq 3.0 V$		20	50	mV
			$3.1 V \leq V_{OUT} \leq 5.0 V$		30	75	
			$5.1 V \leq V_{OUT} \leq 12.0 V$		40	115	
Dropout Voltage	$I_{OUT} = 20 mA$	$V_{DO}$	$2.5 V \leq V_{OUT} \leq 7.0 V$		0.20	0.40	V
			$7.1 V \leq V_{OUT} \leq 10.0 V$		0.25	0.50	
			$10.1 V \leq V_{OUT} \leq 12.0 V$		0.30	0.55	
Output Current	$V_{IN} = V_{OUT(NOM)} + 2.0 V$	$I_{OUT}$	$2.5 V \leq V_{OUT} \leq 2.9 V$	140		mA	
			$3.0 V \leq V_{OUT} \leq 12.0 V$	150			

## NCP4623

### ELECTRICAL CHARACTERISTICS NCP4623Hxxxx, $C_{IN} = C_{OUT} = 0.1 \mu F$ , $T_A = +25^\circ C$

Parameter	Test Conditions	Symbol	Min	Typ	Max	Unit
Short Current Limit	$V_{OUT} = 0 V$	$I_{SC}$		45		mA
Quiescent Current	$V_{IN} = V_{OUT(NOM)} + 2.0 V$ , $V_{CE} = V_{IN}$	$I_Q$		5	10	$\mu A$
Standby Current	$V_{IN} = 24 V$ , $V_{CE} = 0 V$	$I_{STB}$		0.1	1.0	$\mu A$
CE Pin Threshold Voltage	CE Input Voltage "H"	$V_{CEH}$	2.1		$V_{IN}$	V
	CE Input Voltage "L"	$V_{CEL}$	0		0.3	
Power Supply Rejection Ratio	$V_{OUT} = 3.3V V$ , $V_{IN} = 5.3 V$ , $\Delta V_{IN} = 0.2 V_{pk-pk}$ , $I_{OUT} = 30 mA$ , $f = 1 kHz$	PSRR		35		dB
Output Noise Voltage	$f = 10 Hz$ to $100 kHz$ , $V_{OUT} = 3.3 V$ , $V_{IN} = 5.3 V$ , $I_{OUT} = 30 mA$	$V_N$		90		$\mu V_{rms}$
Thermal Shutdown Temperature		$T_{SD}$		150		$^\circ C$
Thermal Shutdown Release Temperature		$T_{SR}$		125		$^\circ C$

### ELECTRICAL CHARACTERISTICS NCP4623HxxxADJ, $V_{ADJ} = V_{OUT}$ , $C_{IN} = C_{OUT} = 0.1 \mu F$ , $T_A = +25^\circ C$

Parameter	Test Conditions	Symbol	Min	Typ	Max	Unit
Operating Input Voltage		$V_{IN}$	2		24	V
Output Voltage	$V_{IN} = V_{OUT(NOM)} + 2.0 V$ , $I_{OUT} = 20 mA$	$V_{OUT}$	2.45	2.50	2.55	V
Output Voltage Temp. Coefficient	$V_{IN} = V_{OUT(NOM)} + 2.0 V$ , $I_{OUT} = 20 mA$ , $-40^\circ C \leq T_A \leq 105^\circ C$	$\Delta V_{OUT}/\Delta T_A$		$\pm 100$		ppm/ $^\circ C$
Line Regulation	$V_{OUT(NOM)} + 1 V \leq V_{IN} \leq 24 V$ , $I_{OUT} = 20 mA$	LineReg		0.05	0.20	%/V
Load Regulation	$V_{IN} = V_{OUT(NOM)} + 2.0 V$ , $I_{OUT} = 1 mA$ to $40 mA$	LoadReg		20	50	mV
Dropout Voltage	$I_{OUT} = 20 mA$	$V_{DO}$		0.20	0.40	V
Output Current	$V_{IN} = V_{OUT(NOM)} + 2.0 V$	$I_{OUT}$	140			mA
Short Current Limit	$V_{OUT} = 0 V$	$I_{SC}$		45		mA
3 Quiescent Current	$V_{IN} = V_{OUT(NOM)} + 2.0 V$ , $V_{CE} = V_{IN}$	$I_Q$		5	10	$\mu A$
Standby Current	$V_{IN} = 24 V$ , $V_{CE} = 0 V$	$I_{STB}$		0.1	1.0	$\mu A$
CE Pin Threshold Voltage	CE Input Voltage "H"	$V_{CEH}$	2.1		$V_{IN}$	V
	CE Input Voltage "L"	$V_{CEL}$	0		0.3	
Power Supply Rejection Ratio	$V_{IN} = 4.5 V$ , $V_{OUT} = 2.5 V$ , $\Delta V_{IN} = 0.2 V_{pk-pk}$ , $I_{OUT} = 30 mA$ , $f = 1 kHz$	PSRR		40		dB
Output Noise Voltage	$f = 10 Hz$ to $100 kHz$ , $V_{OUT} = 2.5 V$ , $V_{IN} = 4.5 V$ , $I_{OUT} = 30 mA$	$V_N$		80		$\mu V_{rms}$
Thermal Shutdown Temperature		$T_{SD}$		150		$^\circ C$
Thermal Shutdown Release Temperature		$T_{SR}$		125		$^\circ C$

TYPICAL CHARACTERISTICS

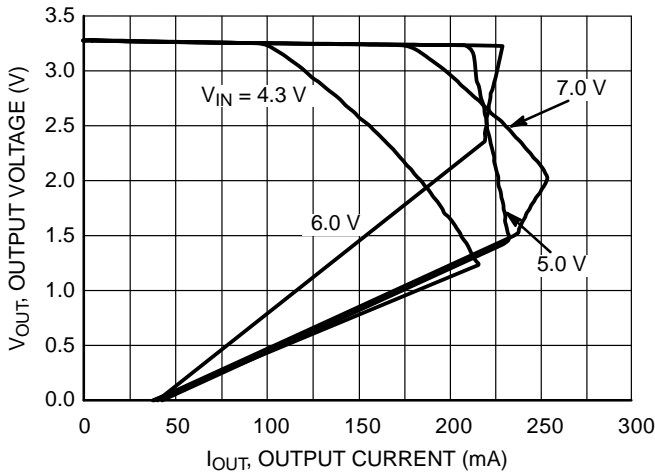

Figure 3. Output Voltage vs. Output Current  
3.3 V Version ( $T_J = 25^\circ\text{C}$ )

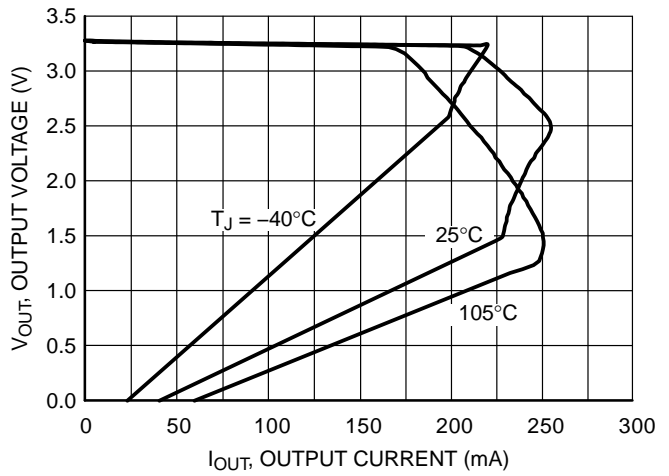

Figure 4. Output Voltage vs. Output Current  
3.3 V Version  $V_{IN} = 5.3\text{ V}$

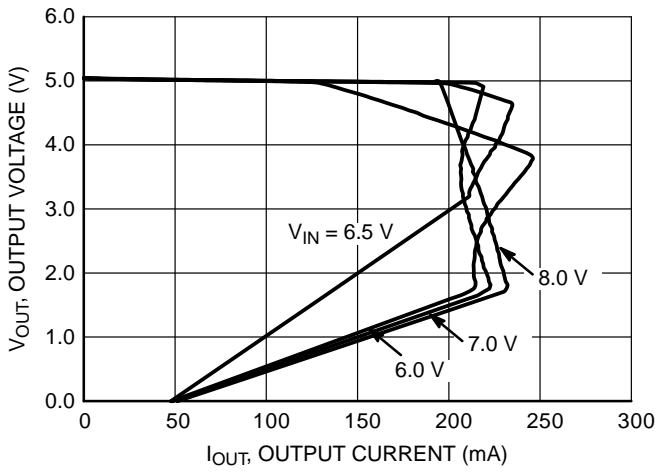

Figure 5. Output Voltage vs. Output Current  
5.0 V Version ( $T_J = 25^\circ\text{C}$ )

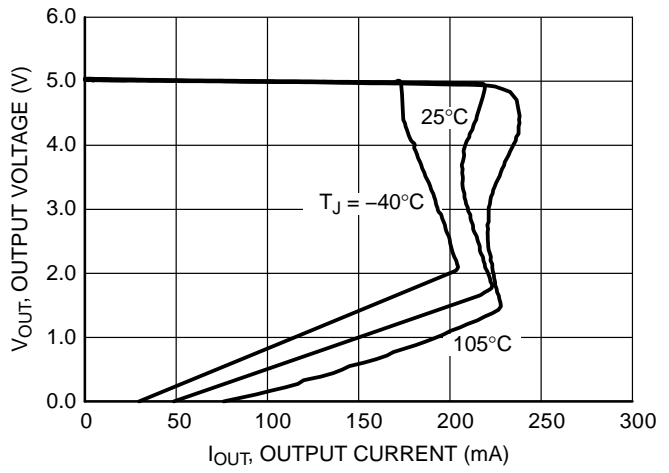

Figure 6. Output Voltage vs. Output Current  
5.0 V Version  $V_{IN} = 7.0\text{ V}$

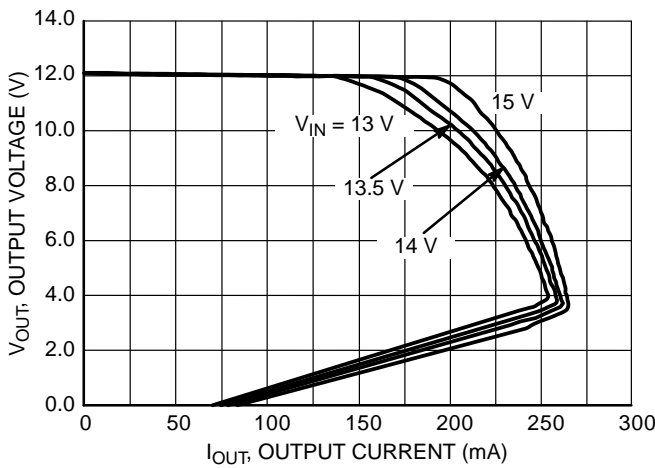

Figure 7. Output Voltage vs. Output Current  
12.0 V Version ( $T_J = 25^\circ\text{C}$ )

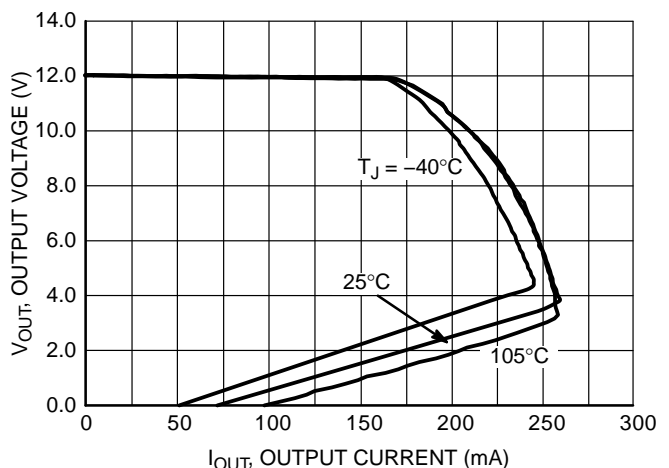

Figure 8. Output Voltage vs. Output Current  
12.0 V Version  $V_{IN} = 14.0\text{ V}$

TYPICAL CHARACTERISTICS

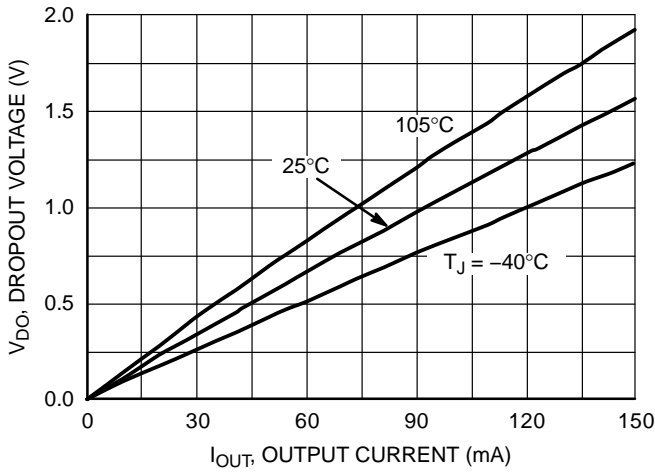

Figure 9. Dropout Voltage vs. Output Current  
3.3 V Version

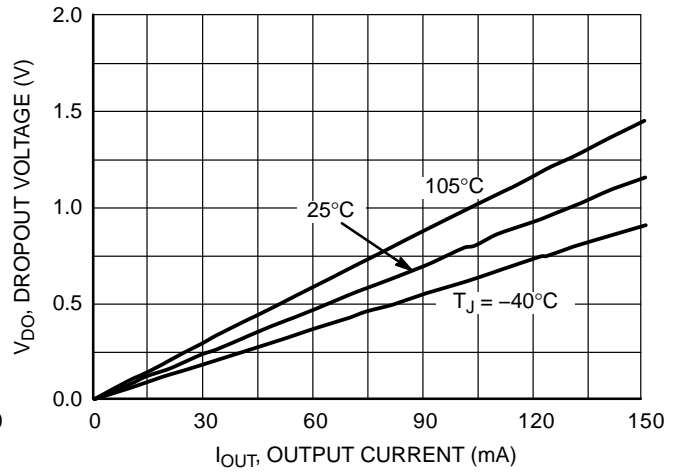

Figure 10. Dropout Voltage vs. Output Current  
5.0 V Version

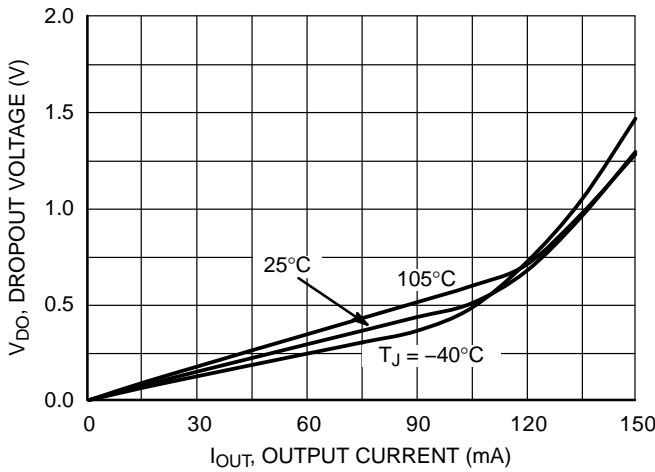

Figure 11. Dropout Voltage vs. Output Current  
12.0 V Version

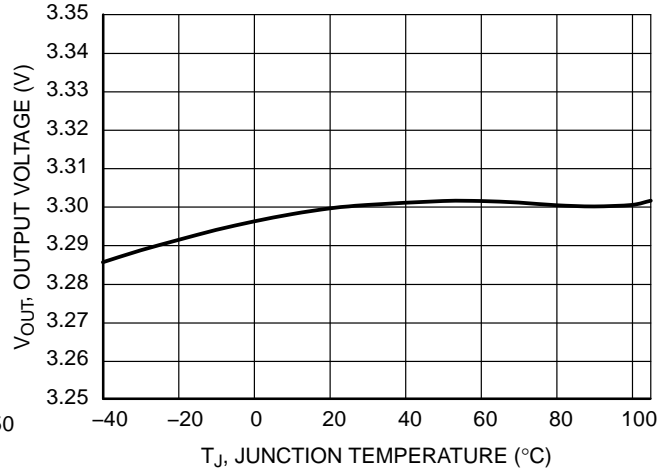

Figure 12. Output Voltage vs. Temperature,  
3.3 V Version,  $V_{IN} = 5.3$  V,  $I_{OUT} = 20$  mA

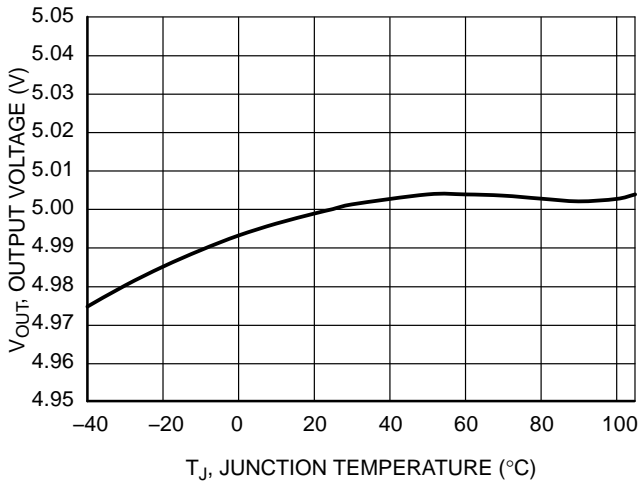

Figure 13. Output Voltage vs. Temperature,  
5.0 V Version,  $V_{IN} = 7.0$  V,  $I_{OUT} = 20$  mA

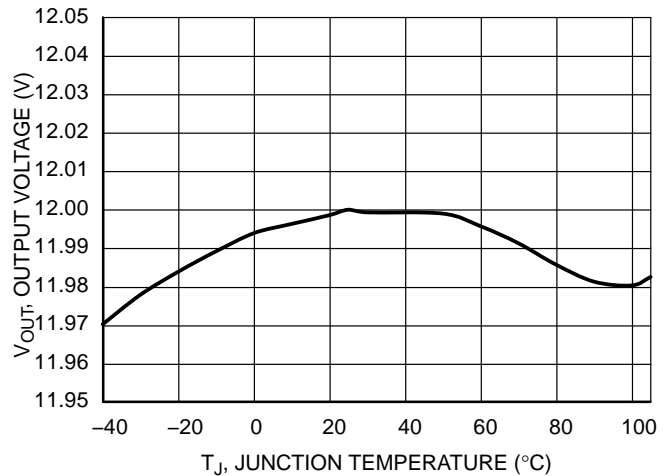

Figure 14. Output Voltage vs. Temperature,  
12.0 V Version,  $V_{IN} = 14.0$  V,  $I_{OUT} = 20$  mA

# NCP4623

## TYPICAL CHARACTERISTICS

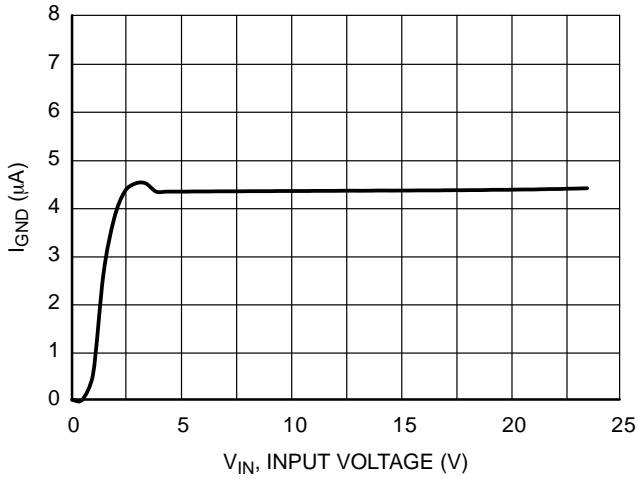

Figure 15. Supply Current vs. Input Voltage, 3.3 V Version

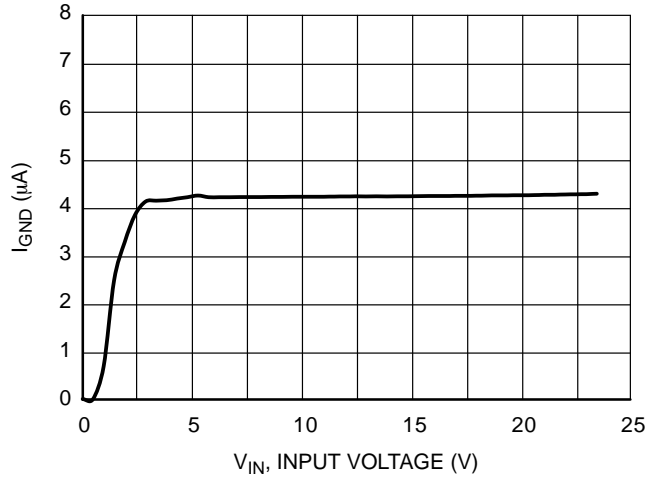

Figure 16. Supply Current vs. Input Voltage, 5.0 V Version

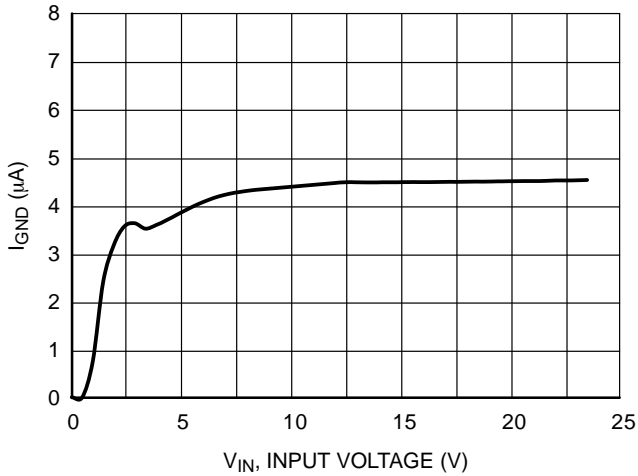

Figure 17. Supply Current vs. Input Voltage, 12.0 V Version

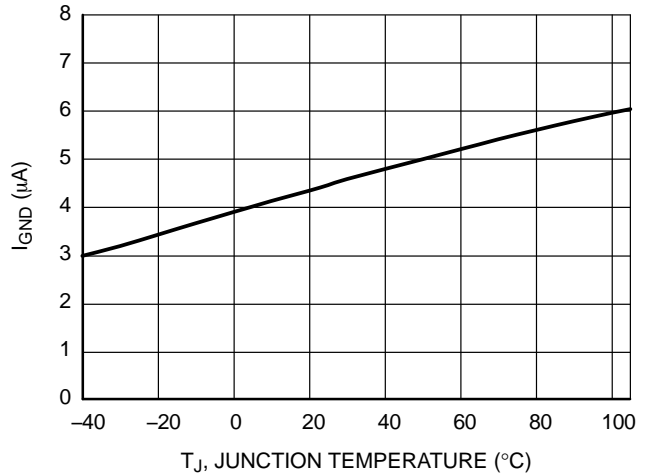

Figure 18. Supply Current vs. Temperature, 3.3 V Version, V<sub>IN</sub> = 5.3 V

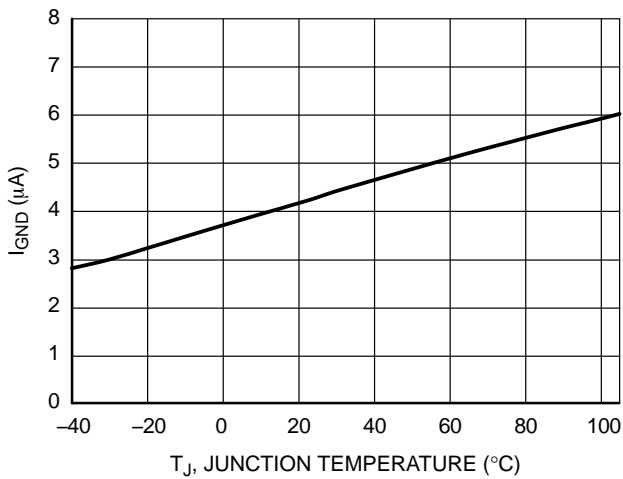

Figure 19. Supply Current vs. Temperature, 5.0 V Version, V<sub>IN</sub> = 7.0 V

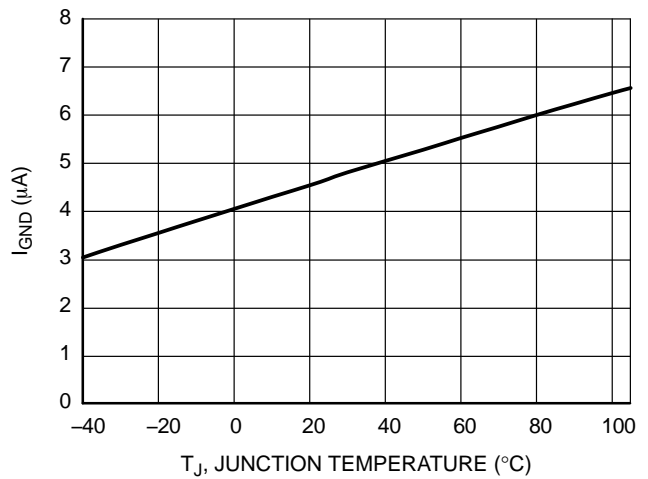

Figure 20. Supply Current vs. Temperature, 12.0 V Version, V<sub>IN</sub> = 14.0 V



TYPICAL CHARACTERISTICS

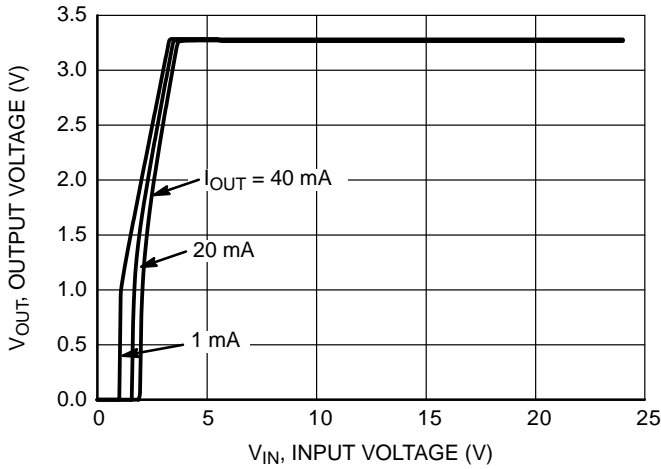

Figure 21. Output Voltage vs. Input Voltage, 3.3 V Version

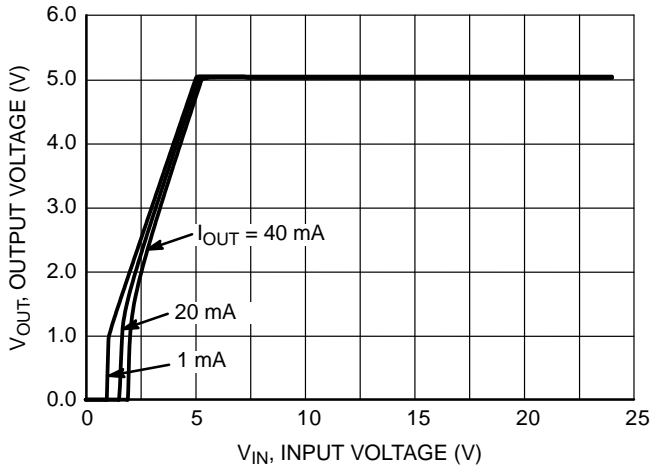

Figure 22. Output Voltage vs. Input Voltage, 5.0 V Version

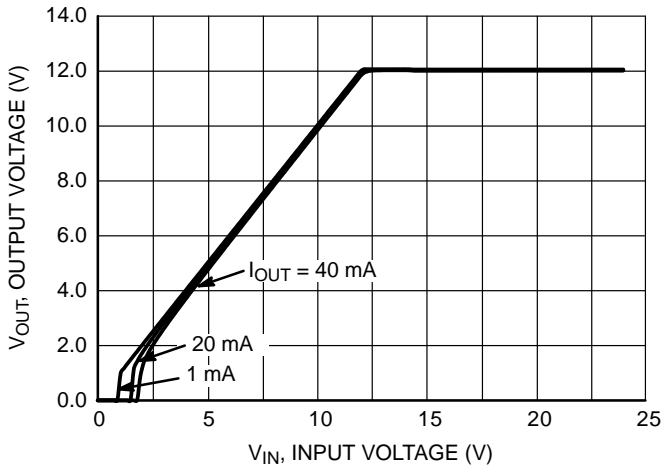

Figure 23. Output Voltage vs. Input Voltage, 12.0 V Version

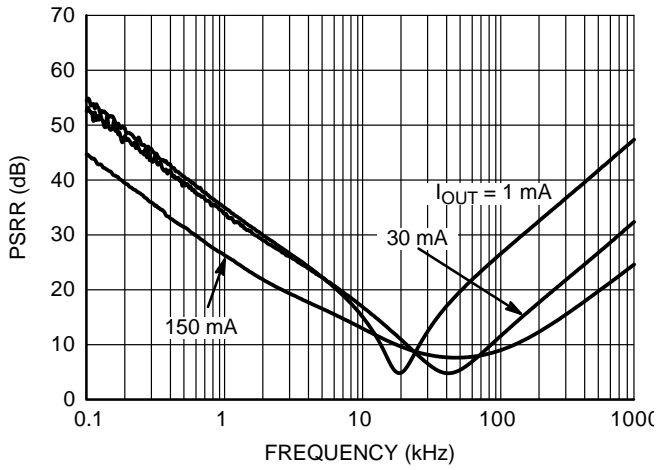

Figure 24. PSRR, 3.3 V Version,  $V_{IN} = 6.3 V$

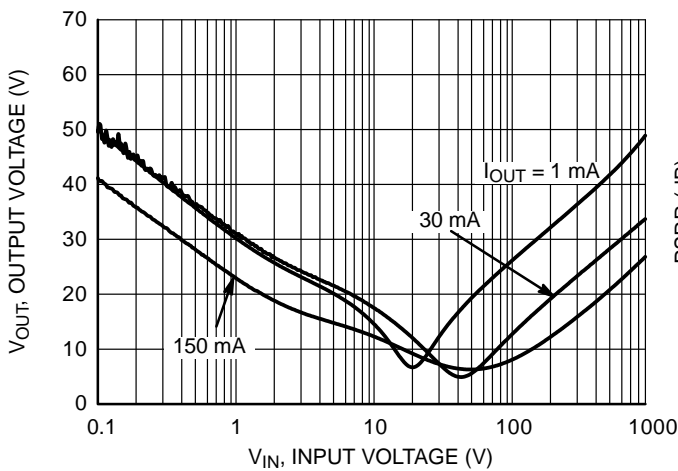

Figure 25. PSRR, 5.0 V Version,  $V_{IN} = 8.0 V$

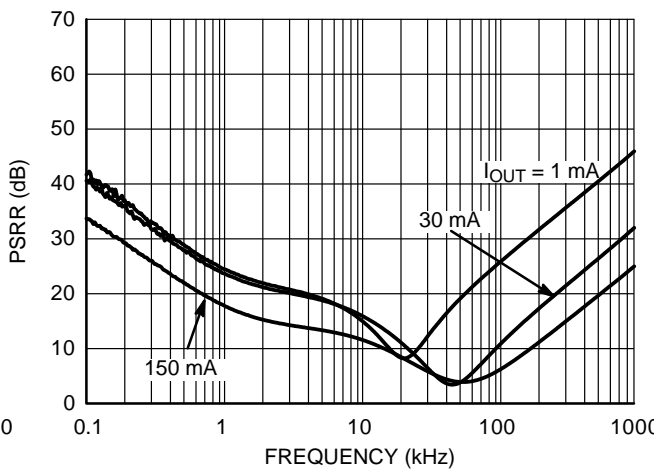

Figure 26. PSRR, 12.0 V Version,  $V_{IN} = 15.0 V$

TYPICAL CHARACTERISTICS

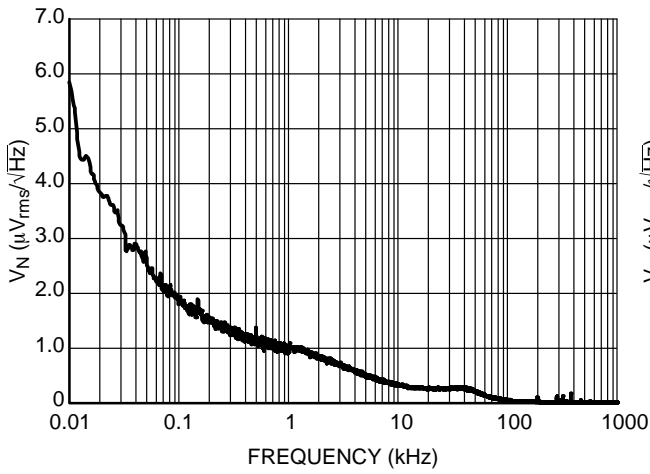

Figure 27. Output Voltage Noise, 3.3 V Version,  $V_{IN} = 5.3 \text{ V}$ ,  $I_{OUT} = 30 \text{ mA}$

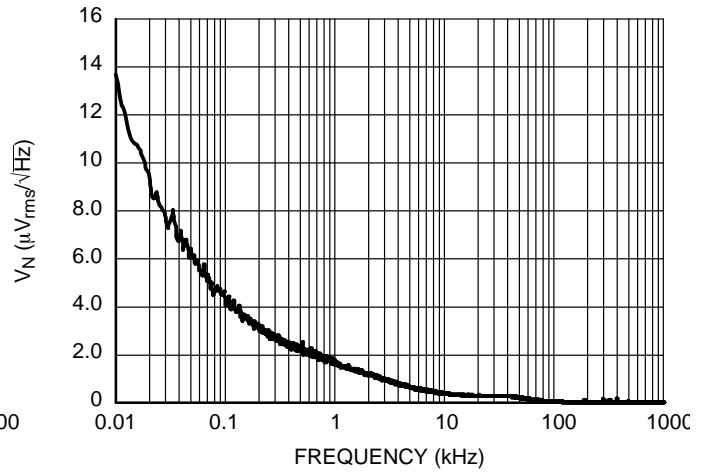

Figure 28. Output Voltage Noise, 5.0 V Version,  $V_{IN} = 7.0 \text{ V}$ ,  $I_{OUT} = 30 \text{ mA}$

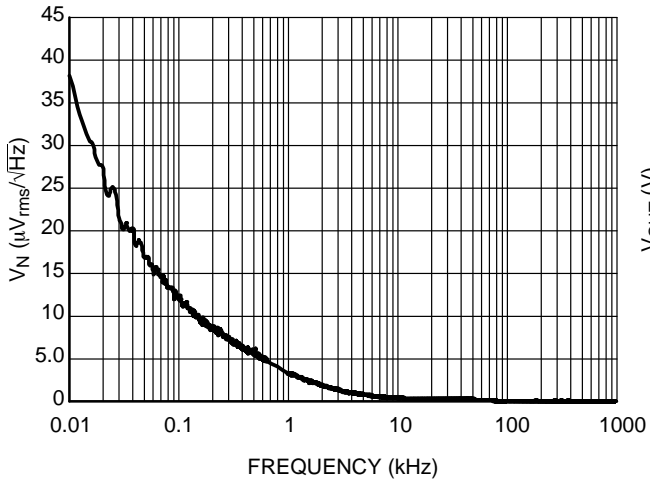

Figure 29. Output Voltage Noise, 12.0 V Version,  $V_{IN} = 14.0 \text{ V}$ ,  $I_{OUT} = 30 \text{ mA}$

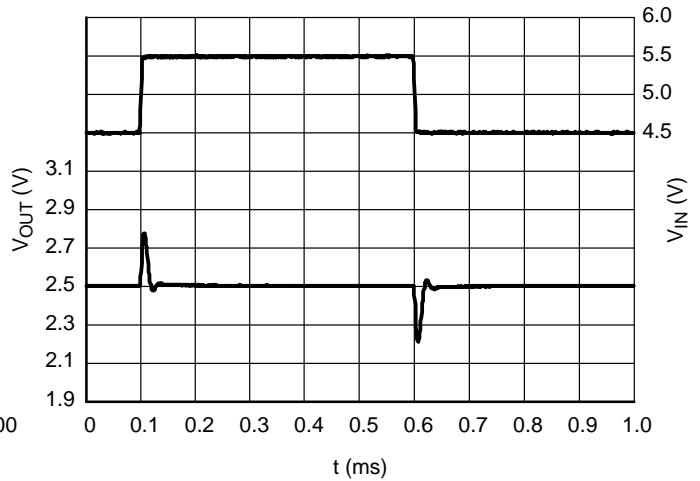

Figure 30. Line Transients, 2.5 V Version,  $t_R = t_F = 5 \mu\text{s}$ ,  $I_{OUT} = 30 \text{ mA}$

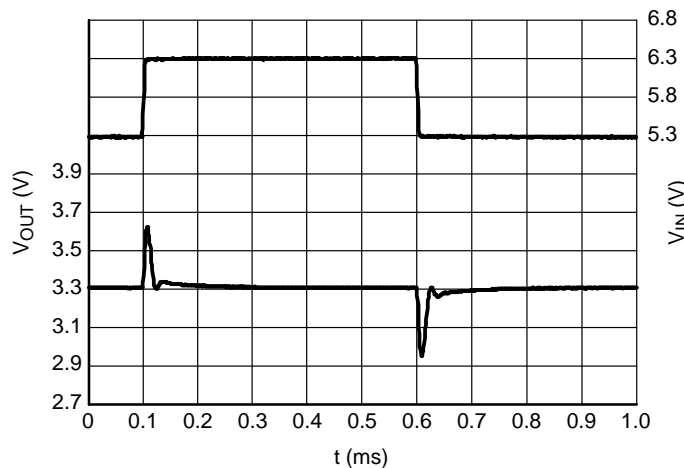

Figure 31. Line Transients, 3.3 V Version,  $t_R = t_F = 5 \mu\text{s}$ ,  $I_{OUT} = 30 \text{ mA}$

# NCP4623

## TYPICAL CHARACTERISTICS

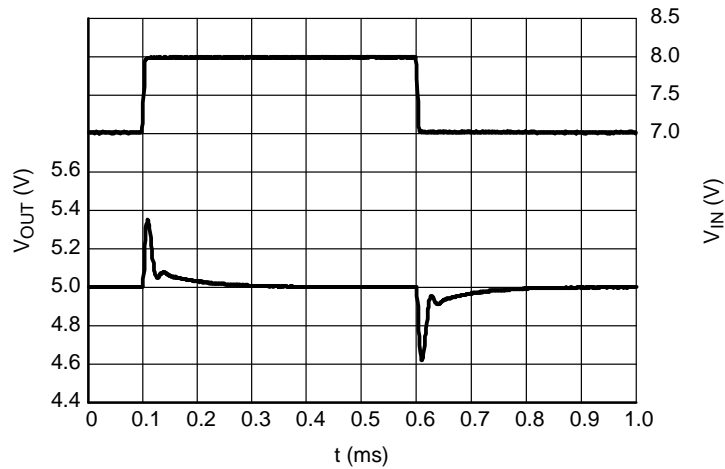

Figure 32. Line Transients, 5.0 V Version,  
 $t_R = t_F = 5 \mu s$ ,  $I_{OUT} = 30 \text{ mA}$

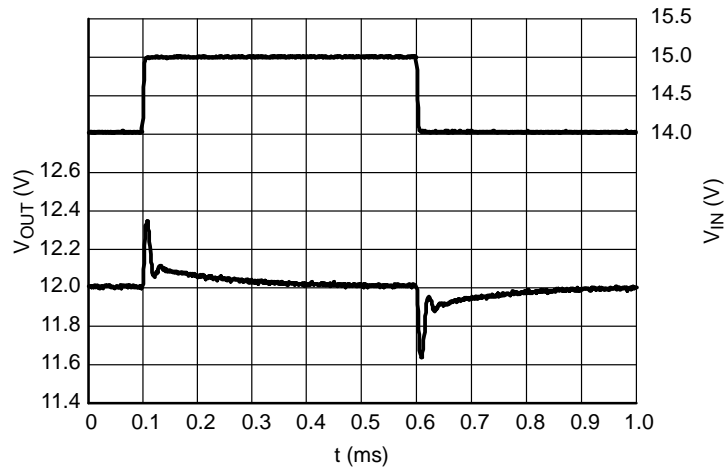
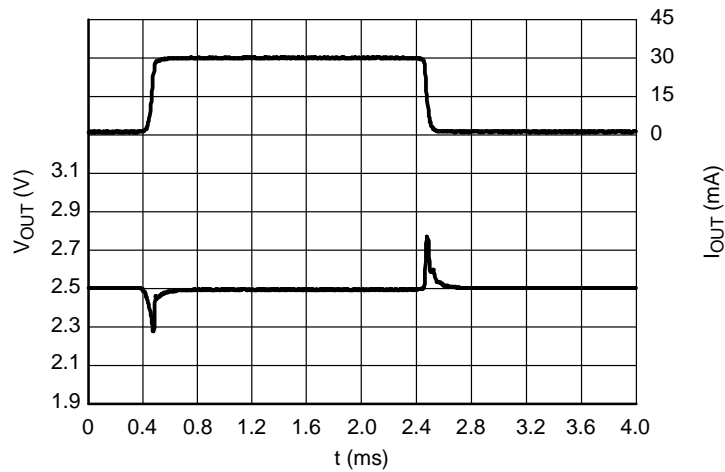

Figure 33. Line Transients, 12.0 V Version,  
 $t_R = t_F = 5 \mu s$ ,  $I_{OUT} = 30 \text{ mA}$



Load Transients, 2.5 V Version,  $I_{OUT} = 1 - 30 \text{ mA}$ ,  $t_R = t_F = 50 \mu s$ ,  $V_{IN} = 4.5 \text{ V}$

# NCP4623

## TYPICAL CHARACTERISTICS

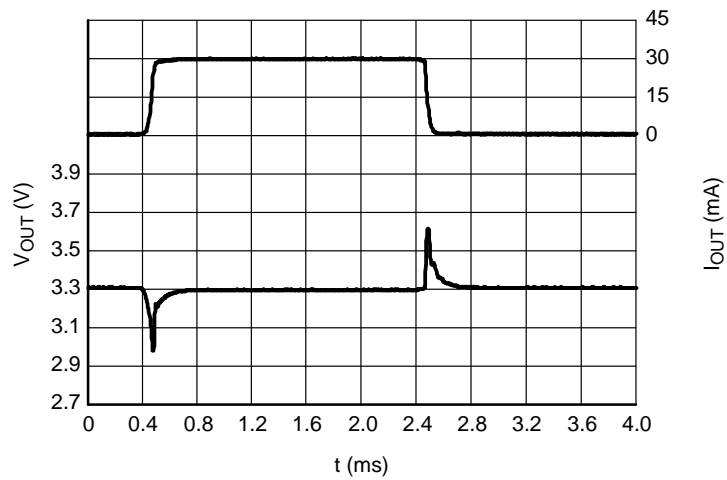

**Figure 34 - Load Transients, 3.3 V Version,  
 $I_{OUT} = 1 - 30$  mA,  $t_R = t_F = 50$   $\mu$ s,  $V_{IN} = 5.3$  V**

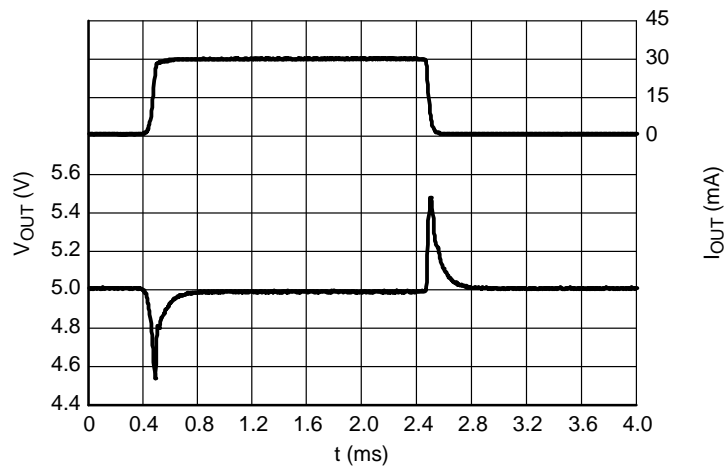

**Figure 35. Load Transients, 5.0 V Version,  
 $I_{OUT} = 1 - 30$  mA,  $t_R = t_F = 50$   $\mu$ s,  $V_{IN} = 7.0$  V**

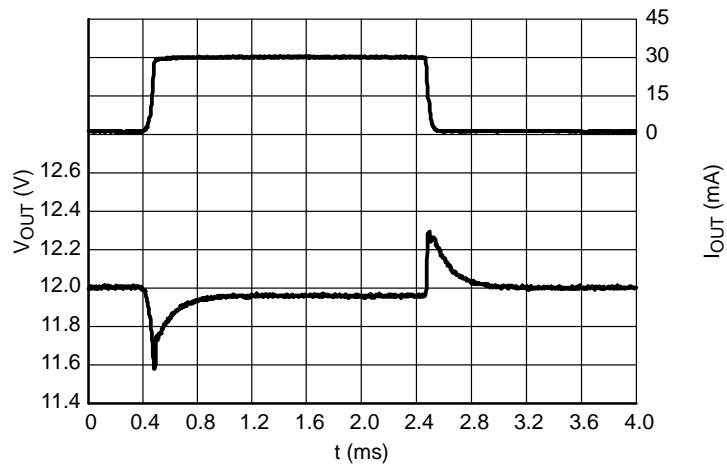

**Figure 36. Load Transients, 12.0 V Version,  
 $I_{OUT} = 1 - 30$  mA,  $t_R = t_F = 50$   $\mu$ s,  $V_{IN} = 14.0$  V**

# NCP4623

## TYPICAL CHARACTERISTICS

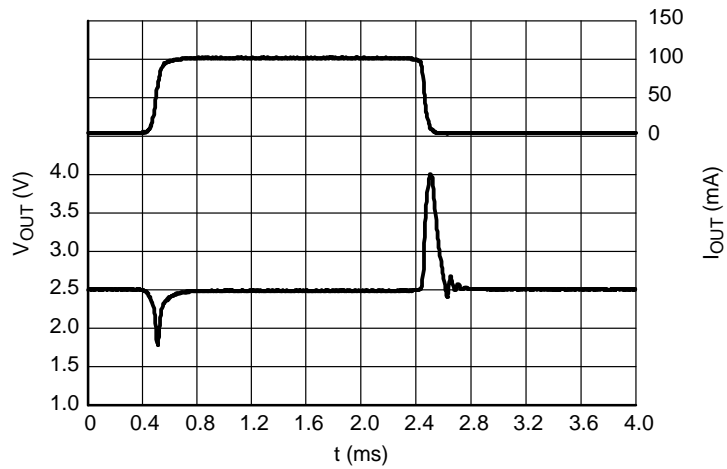

**Figure 37. Load Transients, 2.5 V Version,  
 $I_{OUT} = 1 - 100$  mA,  $t_R = t_F = 50$   $\mu$ s,  $V_{IN} = 4.5$  V**

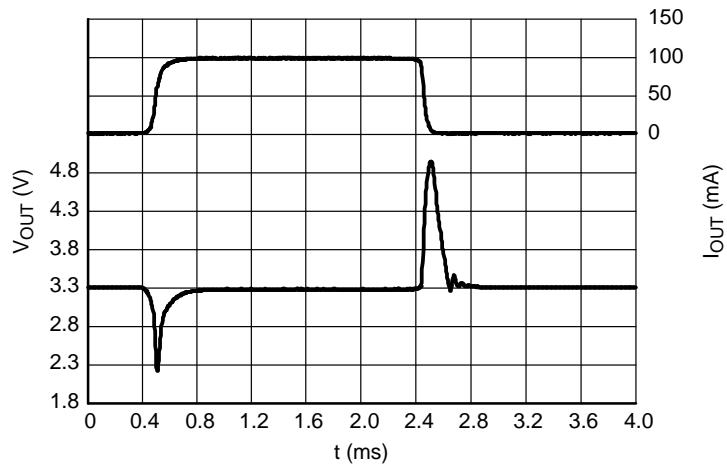

**Figure 38. Load Transients, 3.3 V Version,  
 $I_{OUT} = 1 - 100$  mA,  $t_R = t_F = 50$   $\mu$ s,  $V_{IN} = 5.3$  V**

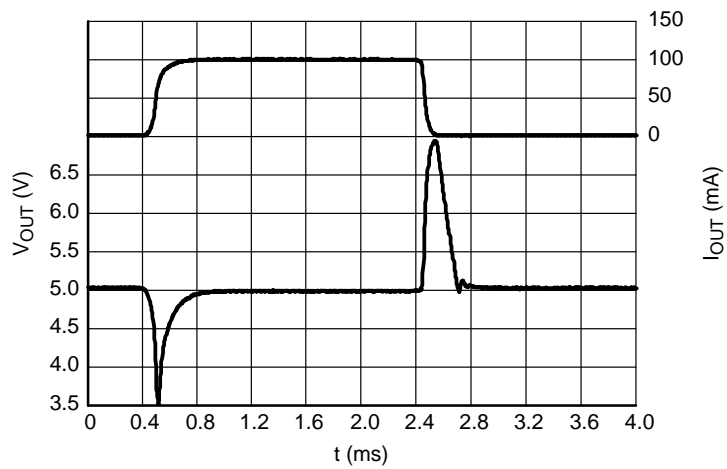

**Figure 39. Load Transients, 5.0 V Version,  
 $I_{OUT} = 1 - 100$  mA,  $t_R = t_F = 50$   $\mu$ s,  $V_{IN} = 7.0$  V**

# NCP4623

## TYPICAL CHARACTERISTICS

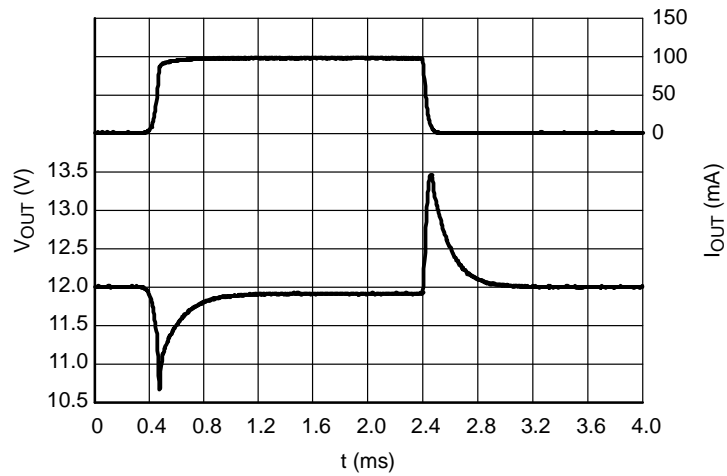

**Figure 40. Load Transients, 12.0 V Version,  $I_{OUT} = 1 - 100 \text{ mA}$ ,  $t_R = t_F = 50 \mu\text{s}$ ,  $V_{IN} = 14.0 \text{ V}$**

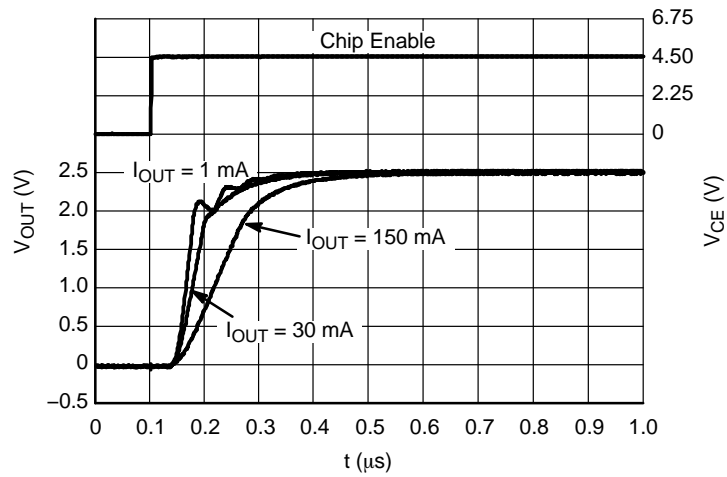

**Figure 41. Start-up, 2.5 V Version,  $V_{IN} = 4.5 \text{ V}$**

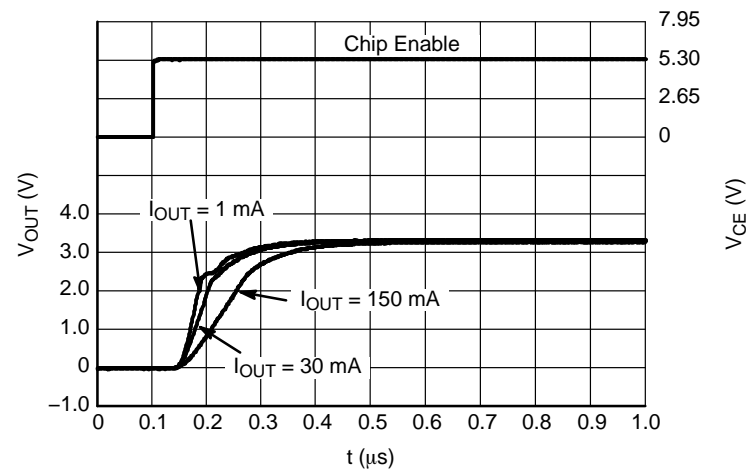

**Figure 42. Start-up, 3.3 V Version,  $V_{IN} = 5.3 \text{ V}$**

# NCP4623

## TYPICAL CHARACTERISTICS

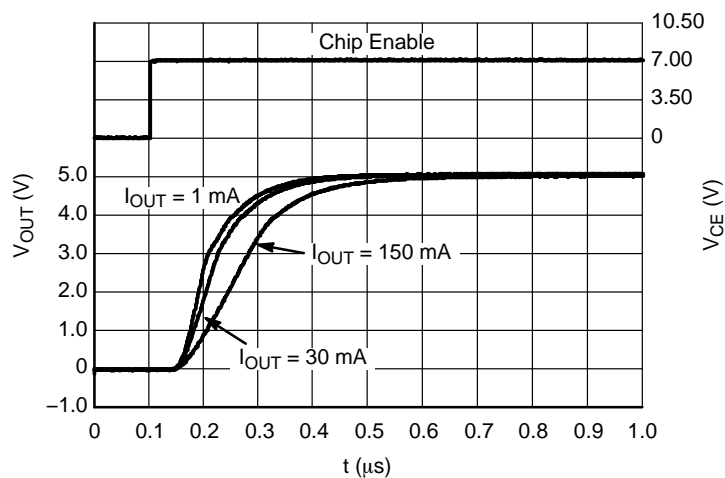

Figure 43. Start-up, 5.0 V Version,  $V_{IN} = 7.0$  V

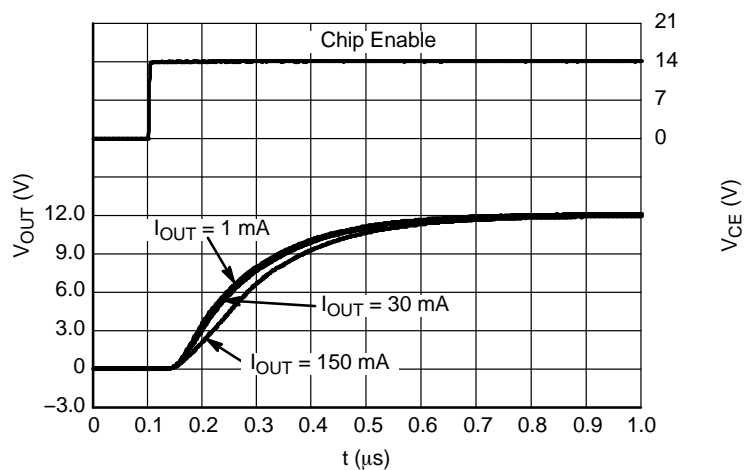

Figure 45. Start-up, 12.0 V Version,  $V_{IN} = 14.0$  V

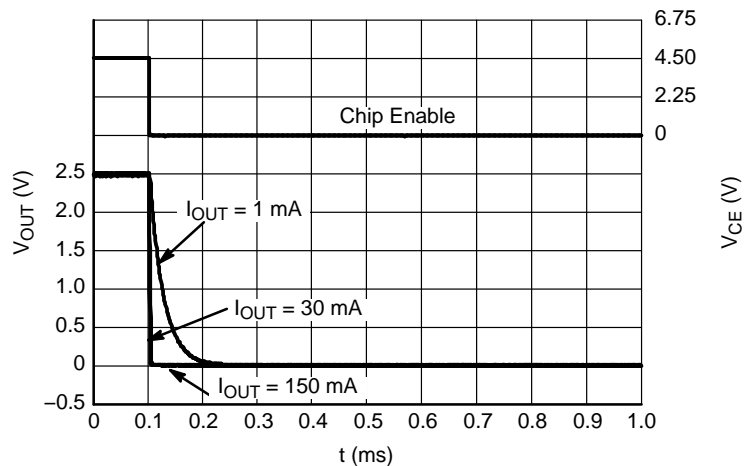

Figure 44. Shutdown, 2.5 V Version,  $V_{IN} = 4.5$  V

# NCP4623

## TYPICAL CHARACTERISTICS

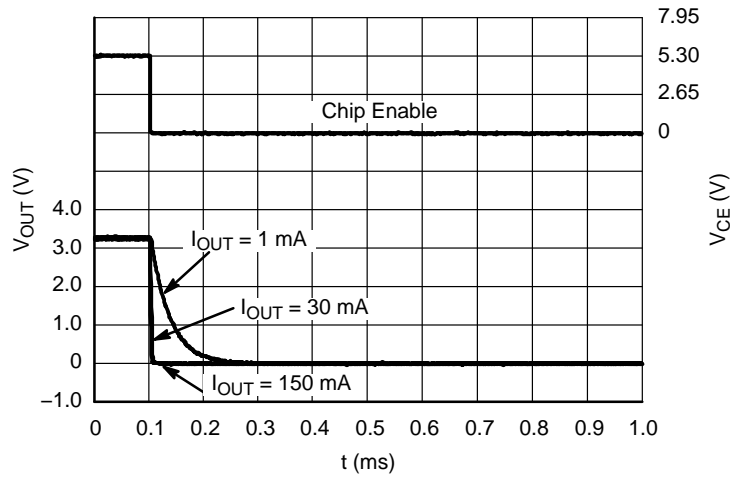

Figure 46. Shutdown, 3.3 V Version,  $V_{IN} = 5.3$  V

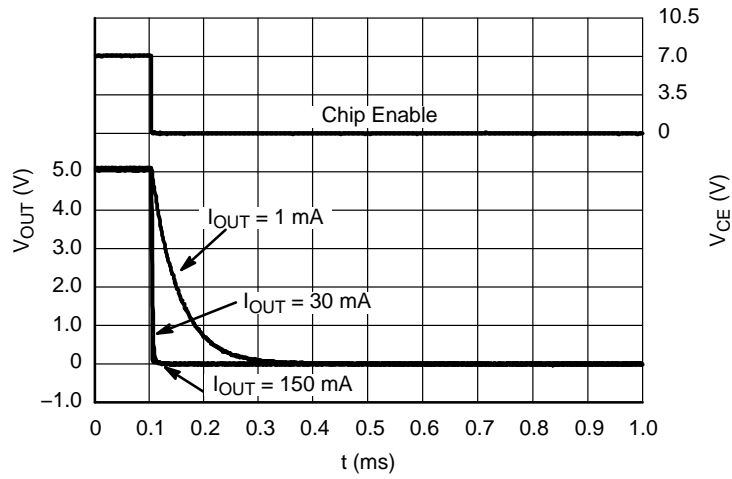

Figure 47. Shutdown, 5.0 V Version,  $V_{IN} = 7.0$  V

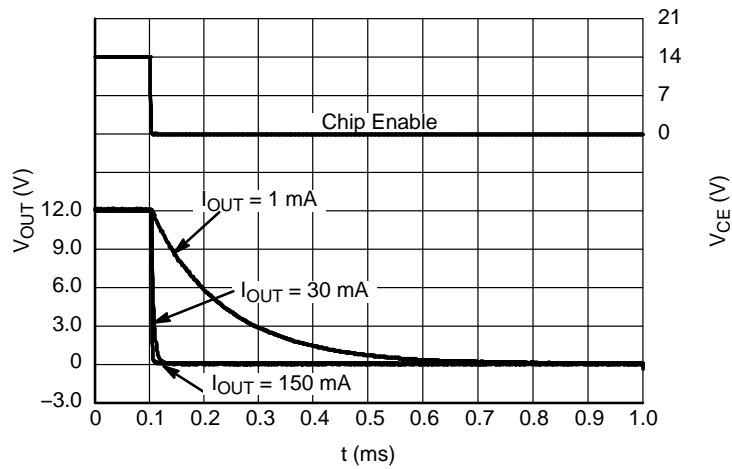

Figure 48. Shutdown, 12.0 V Version,  $V_{IN} = 14.0$  V



## APPLICATION INFORMATION

A typical application circuits for NCP4623 series is shown in Figure 49.

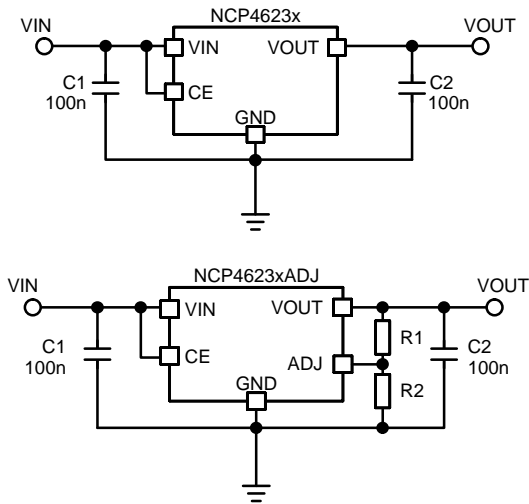

Figure 49. Typical Application Schematics

#### Input Decoupling Capacitor (C1)

A 0.1  $\mu\text{F}$  ceramic input decoupling capacitor should be connected as close as possible to the input and ground pin of the NCP4623. Higher values and lower ESR improves line transient response.

#### Output Decoupling Capacitor (C2)

Recommended values of the ceramic output decoupling capacitor is in the range from 0.1  $\mu\text{F}$  to 2.2  $\mu\text{F}$ . Stable operation of the regulator should be achieved within this range. If a tantalum capacitor is used, and its ESR is high, loop oscillation may result. The capacitors should be connected as close as possible to the output and ground pins. Larger values and lower ESR improves dynamic parameters.

#### Output Voltage Setting (ADJ version)

The output voltage of the adjustable regulator may be set for any output voltage from its voltage reference (2.5 V) up to  $V_{\text{IN}}$  voltage by an external voltage divider connected between VOUT and GND pins with its center connected to the ADJ pin. The voltage divider is loaded by current into ADJ pin that is typically around 200 nA. This current may cause an error in  $V_{\text{OUT}}$ , therefore it is good to choose values

of voltage divider low enough to achieve cross current around 2  $\mu\text{A}$  to eliminate error. Output voltage can be computed from the equation:

$$V_{\text{OUT}} = 2.5 \left( 1 + \frac{R1}{R2} \right) + R1 \cdot I_{\text{ADJ}} \quad (\text{eq. 1})$$

#### Enable Operation

The enable pin CE may be used for turning the regulator on and off. The IC is switched on when a high level voltage is applied to the CE pin. Do not leave the CE pin unconnected or between VCEH and VCEL voltage levels as this may leave the output voltage unstable or cause indefinite and unexpected currents flows internally.

#### Current Limit

This regulator includes a fold-back type current limit circuit. This type of protection doesn't limit output current up to specified current capability in normal operation, but when an over current occurs, output voltage and current decrease until the over current condition ends. Typical characteristics of this protection type can be observed in the Output Voltage vs. Output Current graphs shown in the typical characteristics section of this datasheet.

#### Thermal

As power across the IC increase, it might become necessary to provide some thermal relief. The maximum power dissipation supported by the device is dependent upon board design and layout. Mounting pad configuration on the PCB, the board material, and also the ambient temperature affect the rate of temperature increase for the part. When the device has good thermal conductivity through the PCB the junction temperature will be relatively low in high power dissipation applications.

The IC includes internal thermal shutdown circuit that stops operation of regulator, if junction temperature is higher than 150°C. After that, when junction temperature decreases below 125°C, the operation of voltage regulator will resume. During high power dissipation condition, the regulator shuts down and resumes repeatedly protecting itself from overheating.

#### PCB layout

Make the  $V_{\text{IN}}$  and GND line as large as practical. If their impedance is high, noise pickup or unstable operation may result. Connect capacitors C1 and C2 as close as possible to the IC, and make wiring as short as possible.

# NCP4623

## ORDERING INFORMATION

Device	Nominal Output Voltage	Description	Marking	Package	Shipping†
NCP4623HSNADJT1G	Adjustable	Enable high	J24	SOT23-5 (Pb-Free)	3000 / Tape & Reel
NCP4623HSN050T1G	5.0 V	Enable high	J50		
NCP4623HSN100T1G	10.0 V	Enable high	J00		
NCP4623HSN120T1G	12.0 V	Enable high	J20		
NCP4623HMXADJTCG	Adjustable	Enable high	BQ24	XDFN1616-6 (Pb-Free)	5000 / Tape & Reel
NCP4623HMX025TCG	2.5 V	Enable high	BQ25		
NCP4623HMX033TCG	3.3 V	Enable high	BQ33		
NCP4623HMX045TCG	4.5 V	Enable high	BQ45		
NCP4623HMX048TCG	4.8 V	Enable high	BQ48		
NCP4623HMX050TCG	5.0 V	Enable high	BQ50		
NCP4623HMX080TCG	8.0 V	Enable high	BQ80		

†For information on tape and reel specifications, including part orientation and tape sizes, please refer to our Tape and Reel Packaging Specifications Brochure, BRD8011/D.

\*To order other package and voltage variants, please contact your ON Semiconductor sales representative.

# NCP4623

## PACKAGE DIMENSIONS

**XDFN6 1.6x1.6, 0.5P**  
CASE 711AC  
ISSUE O

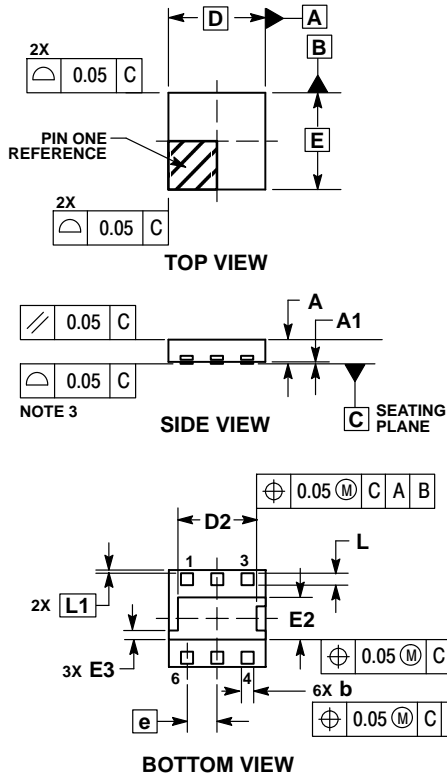

- NOTES:
1. DIMENSIONING AND TOLERANCING PER ASME Y14.5M, 1994.
  2. CONTROLLING DIMENSION: MILLIMETERS.
  3. COPLANARITY APPLIES TO THE EXPOSED PAD AS WELL AS THE TERMINALS.

MILLIMETERS		
DIM	MIN	MAX
A	—	0.40
A1	0.00	0.05
b	0.15	0.25
D	1.60 BSC	
D2	1.25	1.35
E	1.60 BSC	
E2	0.65	0.75
E3	0.15 REF	
e	0.50 BSC	
L	0.15	0.25
L1	0.05 BSC	

### RECOMMENDED MOUNTING FOOTPRINT\*

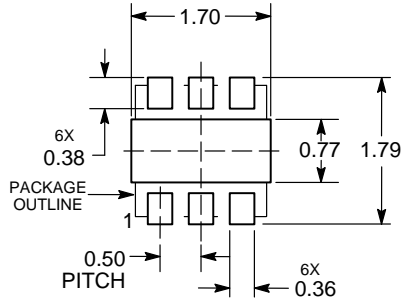

DIMENSIONS: MILLIMETERS

\*For additional information on our Pb-Free strategy and soldering details, please download the ON Semiconductor Soldering and Mounting Techniques Reference Manual, SOLDERRM/D.

# NCP4623

## PACKAGE DIMENSIONS

**SOT-89, 5 LEAD**  
**CASE 528AB**  
**ISSUE O**

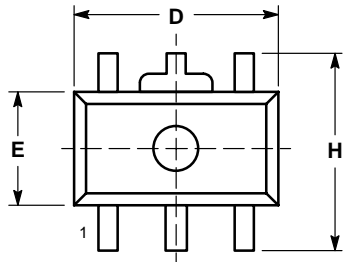

TOP VIEW

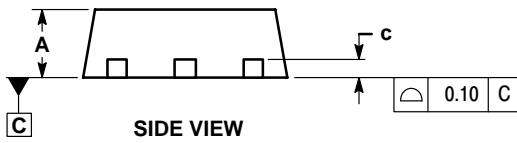

SIDE VIEW

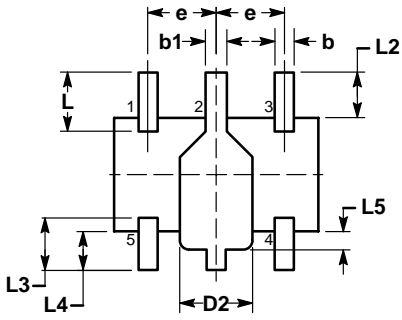

BOTTOM VIEW

NOTES:

1. DIMENSIONING AND TOLERANCING PER ASME Y14.5M, 1994.
2. CONTROLLING DIMENSION: MILLIMETERS.
3. LEAD THICKNESS INCLUDES LEAD FINISH.
4. DIMENSIONS D AND E DO NOT INCLUDE MOLD FLASH, PROTRUSIONS, OR GATE BURRS.
5. DIMENSIONS L, L2, L3, L4, L5, AND H ARE MEASURED AT DATUM PLANE C.

DIM	MILLIMETERS	
	MIN	MAX
A	1.40	1.60
b	0.32	0.52
b1	0.37	0.57
c	0.30	0.50
D	4.40	4.60
D2	1.40	1.80
E	2.40	2.60
e	1.40	1.60
H	4.25	4.45
L	1.10	1.50
L2	0.80	1.20
L3	0.95	1.35
L4	0.65	1.05
L5	0.20	0.60

### RECOMMENDED MOUNTING FOOTPRINT\*

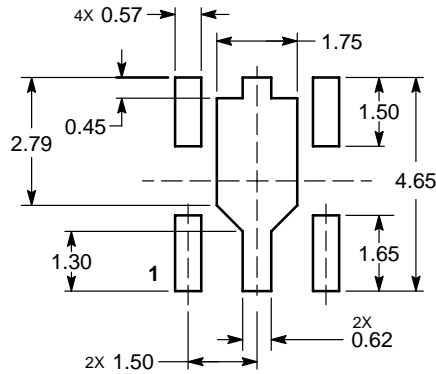

DIMENSIONS: MILLIMETERS

\*For additional information on our Pb-Free strategy and soldering details, please download the ON Semiconductor Soldering and Mounting Techniques Reference Manual, SOLDERRM/D.

# NCP4623

## PACKAGE DIMENSIONS

### SOT-23 5-LEAD CASE 1212 ISSUE A

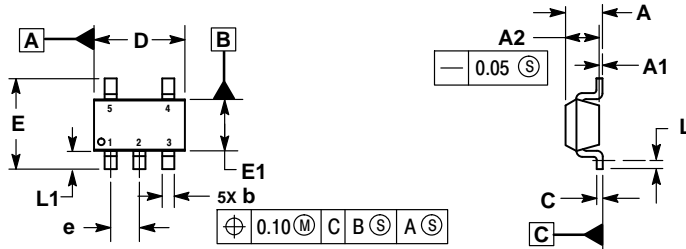

#### NOTES:

1. DIMENSIONING AND TOLERANCING PER ASME Y14.5M, 1994.
2. CONTROLLING DIMENSIONS: MILLIMETERS.
3. DATUM C IS THE SEATING PLANE.

MILLIMETERS		
DIM	MIN	MAX
A	---	1.45
A1	0.00	0.10
A2	1.00	1.30
b	0.30	0.50
c	0.10	0.25
D	2.70	3.10
E	2.50	3.10
E1	1.50	1.80
e	0.95 BSC	
L	0.20	---
L1	0.45	0.75

### RECOMMENDED SOLDERING FOOTPRINT\*

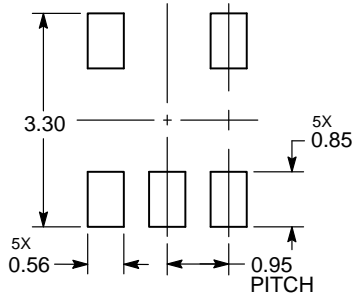

DIMENSIONS: MILLIMETERS

\*For additional information on our Pb-Free strategy and soldering details, please download the ON Semiconductor Soldering and Mounting Techniques Reference Manual, SOLDERRM/D.

ON Semiconductor and the  are registered trademarks of Semiconductor Components Industries, LLC (SCILLC) or its subsidiaries in the United States and/or other countries. SCILLC owns the rights to a number of patents, trademarks, copyrights, trade secrets, and other intellectual property. A listing of SCILLC's product/patent coverage may be accessed at [www.onsemi.com/site/pdf/Patent-Marking.pdf](http://www.onsemi.com/site/pdf/Patent-Marking.pdf). SCILLC reserves the right to make changes without further notice to any products herein. SCILLC makes no warranty, representation or guarantee regarding the suitability of its products for any particular purpose, nor does SCILLC assume any liability arising out of the application or use of any product or circuit, and specifically disclaims any and all liability, including without limitation special, consequential or incidental damages. "Typical" parameters which may be provided in SCILLC data sheets and/or specifications can and do vary in different applications and actual performance may vary over time. All operating parameters, including "Typicals" must be validated for each customer application by customer's technical experts. SCILLC does not convey any license under its patent rights nor the rights of others. SCILLC products are not designed, intended, or authorized for use as components in systems intended for surgical implant into the body, or other applications intended to support or sustain life, or for any other application in which the failure of the SCILLC product could create a situation where personal injury or death may occur. Should Buyer purchase or use SCILLC products for any such unintended or unauthorized application, Buyer shall indemnify and hold SCILLC and its officers, employees, subsidiaries, affiliates, and distributors harmless against all claims, costs, damages, and expenses, and reasonable attorney fees arising out of, directly or indirectly, any claim of personal injury or death associated with such unintended or unauthorized use, even if such claim alleges that SCILLC was negligent regarding the design or manufacture of the part. SCILLC is an Equal Opportunity/Affirmative Action Employer. This literature is subject to all applicable copyright laws and is not for resale in any manner.

### PUBLICATION ORDERING INFORMATION

#### LITERATURE FULFILLMENT:

Literature Distribution Center for ON Semiconductor  
19521 E. 32nd Pkwy, Aurora, Colorado 80011 USA  
Phone: 303-675-2175 or 800-344-3860 Toll Free USA/Canada  
Fax: 303-675-2176 or 800-344-3867 Toll Free USA/Canada  
Email: [orderlit@onsemi.com](mailto:orderlit@onsemi.com)

**N. American Technical Support:** 800-282-9855 Toll Free  
USA/Canada  
**Europe, Middle East and Africa Technical Support:**  
Phone: 421 33 790 2910  
**Japan Customer Focus Center**  
Phone: 81-3-5817-1050

**ON Semiconductor Website:** [www.onsemi.com](http://www.onsemi.com)

**Order Literature:** <http://www.onsemi.com/orderlit>

For additional information, please contact your local Sales Representative

NCP4623/D