

# ON Semiconductor

## Is Now

# onsemi™

To learn more about onsemi™, please visit our website at  
[www.onsemi.com](http://www.onsemi.com)

**onsemi** and **onsemi** and other names, marks, and brands are registered and/or common law trademarks of Semiconductor Components Industries, LLC dba "**onsemi**" or its affiliates and/or subsidiaries in the United States and/or other countries. **onsemi** owns the rights to a number of patents, trademarks, copyrights, trade secrets, and other intellectual property. A listing of **onsemi** product/patent coverage may be accessed at [www.onsemi.com/site/pdf/Patent-Marking.pdf](http://www.onsemi.com/site/pdf/Patent-Marking.pdf). **onsemi** reserves the right to make changes at any time to any products or information herein, without notice. The information herein is provided "as-is" and **onsemi** makes no warranty, representation or guarantee regarding the accuracy of the information, product features, availability, functionality, or suitability of its products for any particular purpose, nor does **onsemi** assume any liability arising out of the application or use of any product or circuit, and specifically disclaims any and all liability, including without limitation special, consequential or incidental damages. Buyer is responsible for its products and applications using **onsemi** products, including compliance with all laws, regulations and safety requirements or standards, regardless of any support or applications information provided by **onsemi**. "Typical" parameters which may be provided in **onsemi** data sheets and/or specifications can and do vary in different applications and actual performance may vary over time. All operating parameters, including "Typicals" must be validated for each customer application by customer's technical experts. **onsemi** does not convey any license under any of its intellectual property rights nor the rights of others. **onsemi** products are not designed, intended, or authorized for use as a critical component in life support systems or any FDA Class 3 medical devices or medical devices with a same or similar classification in a foreign jurisdiction or any devices intended for implantation in the human body. Should Buyer purchase or use **onsemi** products for any such unintended or unauthorized application, Buyer shall indemnify and hold **onsemi** and its officers, employees, subsidiaries, affiliates, and distributors harmless against all claims, costs, damages, and expenses, and reasonable attorney fees arising out of, directly or indirectly, any claim of personal injury or death associated with such unintended or unauthorized use, even if such claim alleges that **onsemi** was negligent regarding the design or manufacture of the part. **onsemi** is an Equal Opportunity/Affirmative Action Employer. This literature is subject to all applicable copyright laws and is not for resale in any manner. Other names and brands may be claimed as the property of others.

# Three Phase Inverter Automotive Power MOSFET Module

## NXV04V120DB1

### Features

- Three-Phase Inverter Bridge for Variable Speed Motor Drive
- RC Snubber for Low EMI
- Current Sensing and Temperature Sensing
- Electrically Isolated DBC Substrate for Low Thermal Resistance
- Compact Design for Low Total Module Resistance
- Module Serialization for Full Traceability
- AEC Qualified – AQG324
- PPAP Capable
- This Device is Pb-free, RoHS and UL94-V0 Compliant

### Applications

- 12 V Motor Control
- Electric and Electro-Hydraulic Power Steering
- Electric Water Pump, Oil Pump and Fan

### Benefits

- Enable Design of Small, Efficient and Reliable System for Reduced Vehicle Fuel Consumption and CO<sub>2</sub> Emission
- Simplified Vehicle Assembly
- Enable Low Thermal Resistance to Junction-to-Heat Sink by Direct Mounting via Thermal Interface Material between Module Case and Heat Sink



ON Semiconductor®

[www.onsemi.com](http://www.onsemi.com)

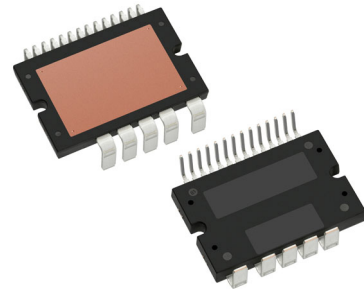

19LD, APM, PDD STD  
CASE MODCD

### MARKING DIAGRAM

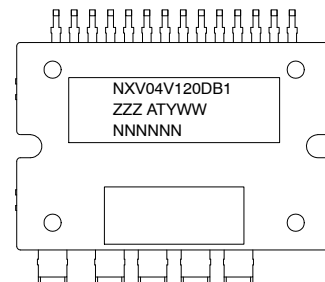

NXV04V120DB1 = Specific Device Code  
ZZZ = Lot ID  
AT = Assembly & Test Location  
Y = Year  
WW = Work Week  
NNN = Serial Number

### ORDERING INFORMATION

See detailed ordering and shipping information on page 2 of this data sheet.

# NXV04V120DB1

## PACKAGE MARKING AND ORDERING INFORMATION

Part Number	Package	Pb-Free and RoHS Compliant	Operating Temperature Range	Packing Method
NXV04V120DB1	APM19-CBC	Yes	-40 ~ 150°C	Tube

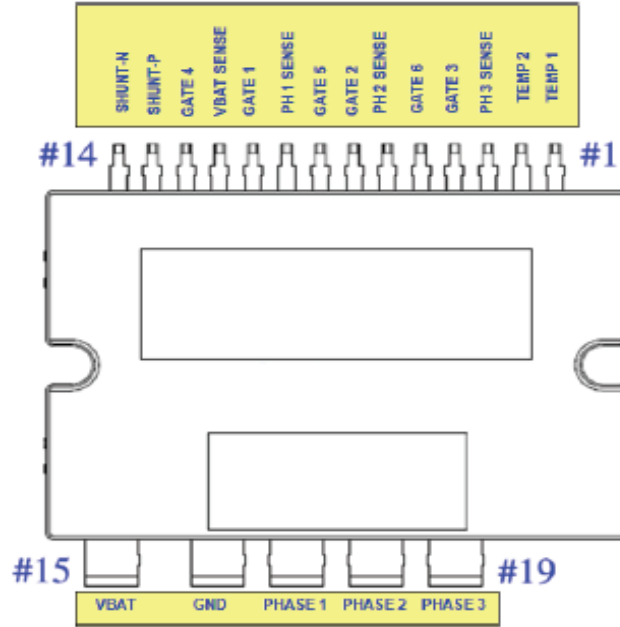

Figure 1. Pin Configuration

## PIN DESCRIPTION

Pin Number	Pin Name	Pin Description
1	TEMP 1	NTC Thermistor Terminal 1
2	TEMP 2	NTC Thermistor Terminal 2
3	PHASE 3 SENSE	Source of Q3 and Drain of Q6
4	GATE 3	Gate of Q3, high side Phase 3 MOSFET
5	GATE 6	Gate of Q6, low side Phase 3 MOSFET
6	PHASE 2 SENSE	Source of Q2 and Drain of Q5
7	GATE 2	Gate of Q2, high side Phase 2 MOSFET
8	GATE 5	Gate of Q5, low side Phase 2 MOSFET
9	PHASE 1 SENSE	Source of Q1 and Drain of Q4
10	GATE 1	Gate of Q2, high side Phase 1 MOSFET
11	VBAT SENSE	Sense pin for battery voltage and Drain of high side MOSFETs
12	GATE 4	Gate of Q4, low side Phase 1 MOSFET
13	SHUNT P	Positive CSR sense pin and source connection for low side MOSFETs
14	SHUNT N	Negative CSR sense pin and sense pin for battery return
15	VBAT	Battery voltage power lead
16	GND	Battery return power lead
17	PHASE 1	Phase 1 power lead
18	PHASE 2	Phase 2 power lead
19	PHASE 3	Phase 3 power lead

# NXV04V120DB1

## Schematic Diagram

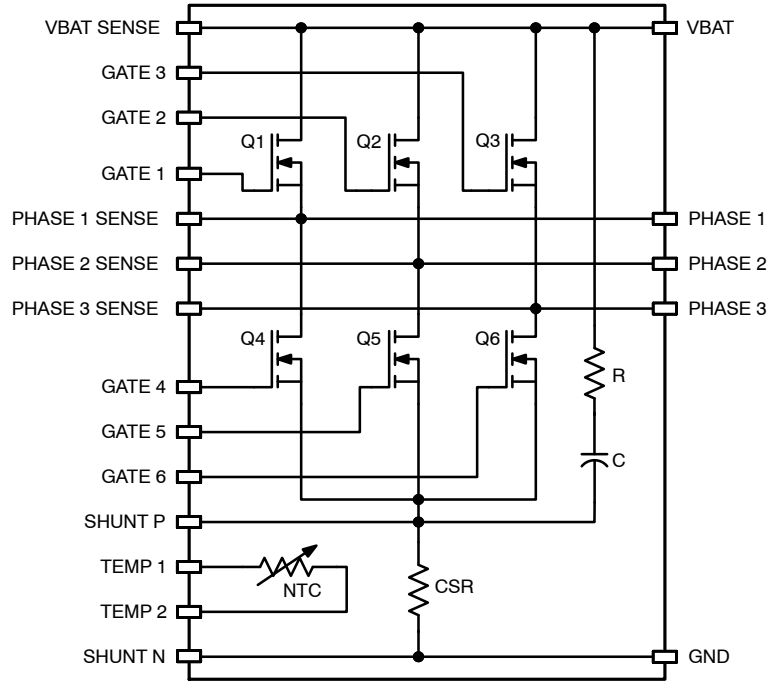

Figure 2. Schematic

### Flammability Information

All materials present in the power module meet UL flammability rating class 94V-0 or higher.

### Solder

Solder used is a lead free SnAgCu alloy.

### Compliance to RoHS Directives

The power module is 100% lead free and RoHS compliant 2000/53/C directive.

### ABSOLUTE MAXIMUM RATINGS ( $T_J = 25^\circ\text{C}$ unless otherwise noted)

Symbol	Parameter	Max	Unit
$V_{DS}$	Drain-to-Source Voltage	40	V
$V_{GS}$	Gate-to-Source Voltage	$\pm 20$	V
$I_D$	Drain Current Continuous ( $T_C = 25^\circ\text{C}$ , $T_J = 175^\circ\text{C}$ ) (Note 1)	160	A
$E_{AS}$	Single Pulse Avalanche Energy (Note 2)	340	mJ
$T_{J(max)}$	Maximum Junction Temperature	175	$^\circ\text{C}$
$T_{STG}$	Storage Temperature Range	150	$^\circ\text{C}$
$V_{ISO}$	Isolation Voltage	2500	V <sub>rms</sub>

Stresses exceeding those listed in the Maximum Ratings table may damage the device. If any of these limits are exceeded, device functionality should not be assumed, damage may occur and reliability may be affected.

1. Defined by design, not subject to production testing. The value is the result of the calculation, Min (package limit max current, Silicon limit max current) where the silicon limit current is calculated based on the maximum value which is not to exceed  $T_J = 175^\circ\text{C}$  on maximum thermal limitation and on resistance.
2. Starting  $T_J = 25^\circ\text{C}$ ,  $L = 0.47\text{ mH}$ ,  $I_{AS} = 50\text{ A}$ ,  $V_{DD} = 40\text{ V}$  during inductor charging and  $V_{DD} = 0\text{ V}$  during time in avalanche.

# NXV04V120DB1

## THERMAL CHARACTERISTICS

Symbol	Parameter	Min	Typ	Max	Unit
$R_{\theta JC}$	Thermal Resistance, Junction-to-Case (Note 3)	-	-	1.2	K/W

3. Test method compliant with MIL-STD-883-1012.1, case temperature measured below the package at the chip center. Cosmetic oxidation and discolor on the DBC surface is allowed.

## MODULE SPECIFIC CHARACTERISTICS ( $T_J = 25^\circ\text{C}$ unless otherwise noted)

Parameters	Test Conditions	Symbol	Min	Typ	Max	Unit
Drain-to-Source Breakdown Voltage	$I_D = 250 \mu\text{A}$ , $V_{GS} = 0 \text{ V}$	$B_{VDSS}$	40	-	-	V
Drain-to-Source Leakage Current	$V_{DS} = 40 \text{ V}$ , $V_{GS} = 0 \text{ V}$	$I_{DSS}$	-	-	1	$\mu\text{A}$
Gate-to-Source Leakage Current	$V_{GS} = \pm 20 \text{ V}$	$I_{GSS}$	-100	-	+100	nA
Gate-to-Source Threshold Voltage	$V_{GS} = V_{DS}$ , $I_D = 250 \mu\text{A}$	$V_{GS(th)}$	2.0	-	4.0	V
Body Diode Forward Voltage of MOSFET	$I_S = 80 \text{ A}$ , $V_{GS} = 0 \text{ V}$	$V_{SD}$	-	-	0.955	V
Drain-to-Source On Resistance, Q1	$I_D = 80 \text{ A}$ , $V_{GS} = 10 \text{ V}$ (Note 4)	$R_{DS(ON)Q1}$	-	0.85	1.1	$\text{m}\Omega$
Drain-to-Source On Resistance, Q2		$R_{DS(ON)Q2}$	-	0.9	1.1	$\text{m}\Omega$
Drain-to-Source On Resistance, Q3		$R_{DS(ON)Q3}$	-	1	1.2	$\text{m}\Omega$
Drain-to-Source On Resistance, Q4		$R_{DS(ON)Q4}$	-	1.1	1.3	$\text{m}\Omega$
Drain-to-Source On Resistance, Q5		$R_{DS(ON)Q5}$	-	1.3	1.5	$\text{m}\Omega$
Drain-to-Source On Resistance, Q6		$R_{DS(ON)Q6}$	-	1.6	1.9	$\text{m}\Omega$
VBAT to PHASE 1	$I_D = 80 \text{ A}$ , $V_{GS} = 10 \text{ V}$	$R_{DS(ON)MQ1}$	-	1.7	2	$\text{m}\Omega$
VBAT to PHASE 2		$R_{DS(ON)MQ2}$	-	1.8	2	$\text{m}\Omega$
VBAT to PHASE 3		$R_{DS(ON)MQ3}$	-	1.9	2.1	$\text{m}\Omega$
PHASE1 to GND		$R_{DS(ON)MQ4}$	-	1.9	2.2	$\text{m}\Omega$
PHASE2 to GND		$R_{DS(ON)MQ5}$	-	2.1	2.4	$\text{m}\Omega$
PHASE3 to GND		$R_{DS(ON)MQ6}$	-	2.4	2.7	$\text{m}\Omega$
Total Loop Resistance B+ $\geq$ Phase $\geq$ GND	$I_D = 80 \text{ A}$ , $V_{GS} = 10 \text{ V}$		-	4.15	4.8	$\text{m}\Omega$

4. All MOSFETs have same size and on resistance. However, the different values listed due to the different access points available inside the module for on resistance measurement. Q1 has the shortest measurement path in the layout, in this reason, on resistance of Q1 can be used for simple power loss calculation.

## COMPONENTS

Symbol	Spec	Quantity	Size
RESISTOR	1.0 $\Omega$	1	142 $\times$ 55 mil
CAPACITOR	100 V, 0.022 $\mu\text{F}$	1	79 $\times$ 49 mil
CURRENT SENSING RESISTOR	0.5 $\text{m}\Omega$	1	250 $\times$ 120 mil
NTC	B57342V5103H060, 10 k $\Omega$	1	63 $\times$ 32 mil

# NXV04V120DB1

## ELECTRICAL CHARACTERISTICS

(T<sub>J</sub> = 25°C unless otherwise noted, Reference typical characteristics of FDBL9406–F085, TOLL)

Symbol	Parameter	Test Conditions	Min	Typ	Max	Unit
--------	-----------	-----------------	-----	-----	-----	------

### DYNAMIC CHARACTERISTICS

C <sub>iss</sub>	Input Capacitance	V <sub>DS</sub> = 25 V, V <sub>GS</sub> = 0 V, f = 1 MHz	–	7735	–	pF
C <sub>oss</sub>	Output Capacitance		–	2160	–	pF
C <sub>rss</sub>	Reverse Transfer Capacitance		–	129	–	pF
R <sub>g</sub>	Gate Resistance	f = 1 MHz	–	2.5	–	Ω
Q <sub>g(ToT)</sub>	Total Gate Charge	V <sub>GS</sub> = 0 to 10 V	–	90	112	nC
Q <sub>g(th)</sub>	Threshold Gate Charge	V <sub>GS</sub> = 0 to 2 V	–	13.5	18	nC
Q <sub>gs</sub>	Gate-to-Source Gate Charge	V <sub>DD</sub> = 32 V, I <sub>D</sub> = 80 A	–	43	–	nC
Q <sub>gd</sub>	Gate-to-Drain "Miller" Charge		–	10	–	nC

### SWITCHING CHARACTERISTICS

t <sub>on</sub>	Turn-On Time	V <sub>DD</sub> = 20 V, I <sub>D</sub> = 80 A, V <sub>GS</sub> = 10 V, R <sub>GEN</sub> = 6 Ω	–	–	102	ns
t <sub>d(on)</sub>	Turn-On Delay Time		–	33	–	ns
t <sub>r</sub>	Turn-On Rise Time		–	40	–	ns
t <sub>d(off)</sub>	Turn-Off Delay Time		–	47	–	ns
t <sub>f</sub>	Turn-Off Fall Time		–	23	–	ns
t <sub>off</sub>	Turn-Off Time		–	–	91	ns

Product parametric performance is indicated in the Electrical Characteristics for the listed test conditions, unless otherwise noted. Product performance may not be indicated by the Electrical Characteristics if operated under different conditions.

TYPICAL CHARACTERISTICS

(Graphs are generated using the die assembled in discrete package for reference purposes only. Datasheet of FDBL9406-F085 is available in the web)

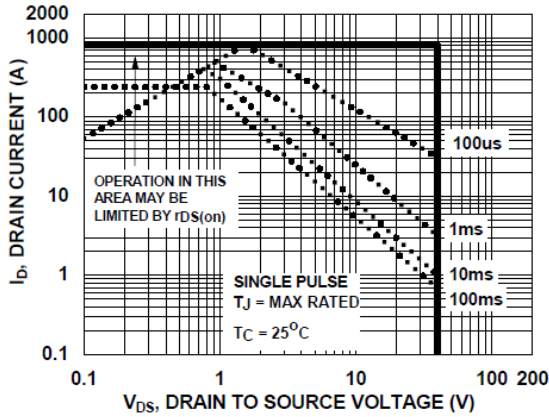
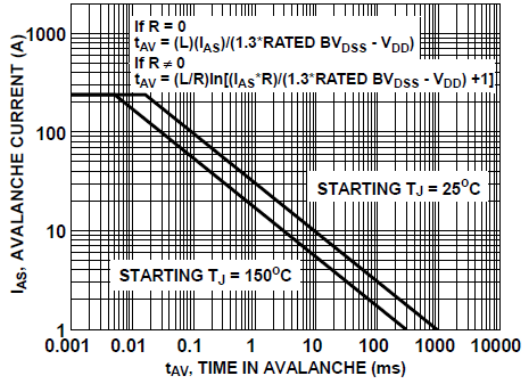

Figure 3. Forward Bias Safe Operating Area



NOTE: Refer to ON Semiconductor Application Notes AN7514 and AN7515

Figure 4. Unclamped Inductive Switching Capability

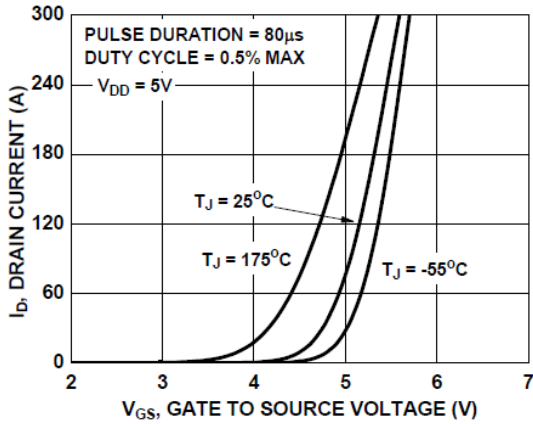

Figure 5. Transfer Characteristics

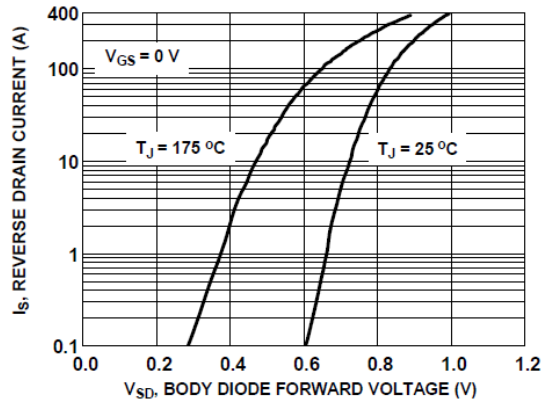

Figure 6. Forward Diode Characteristics

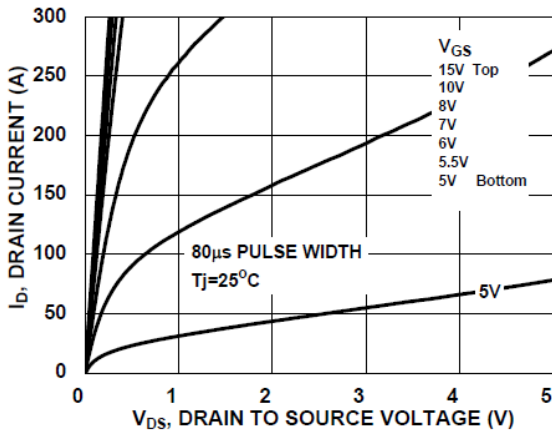

Figure 7. Saturation Characteristics

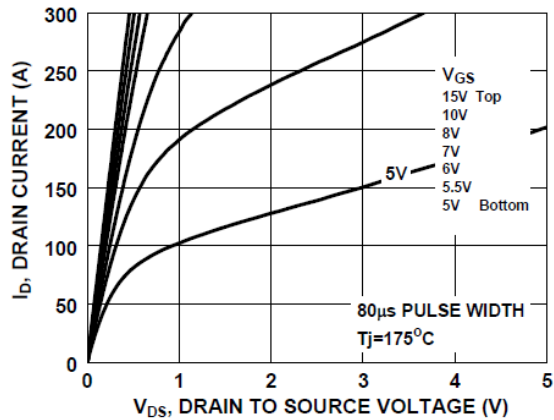

Figure 8. Saturation Characteristics

# NXV04V120DB1

## TYPICAL CHARACTERISTICS (continued)

(Graphs are generated using the die assembled in discrete package for reference purposes only. Datasheet of FDBL9406-F085 is available in the web)

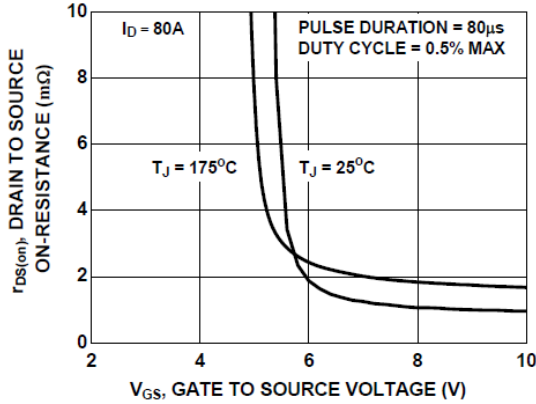

Figure 9.  $R_{DS(on)}$  vs. Gate Voltage

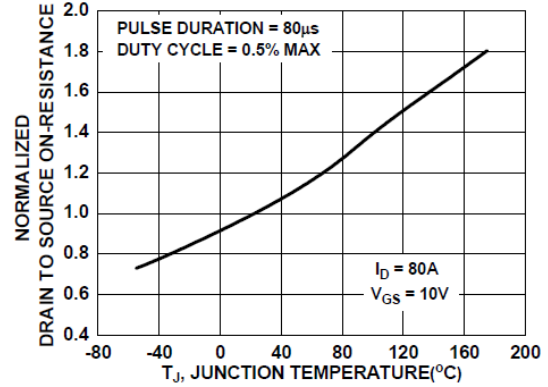

Figure 10. Normalized  $R_{DS(on)}$  vs. Junction Temperature

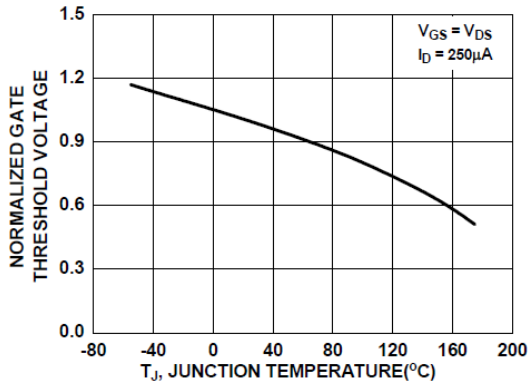

Figure 11. Normalized Gate Threshold Voltage vs. Temperature

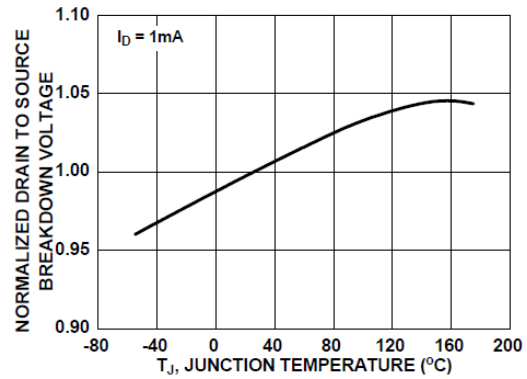

Figure 12. Normalized Drain-to-Source Breakdown Voltage vs. Junction Temperature

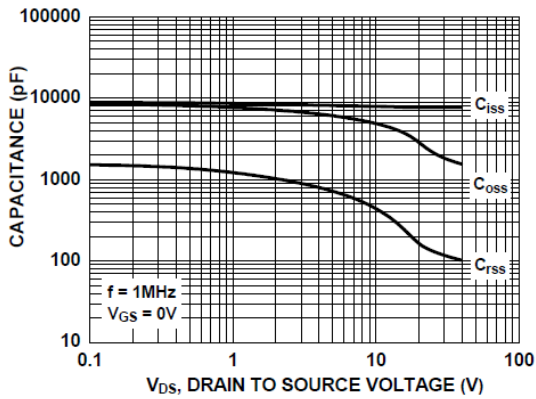

Figure 13. Capacitance vs. Drain-to-Source Voltage

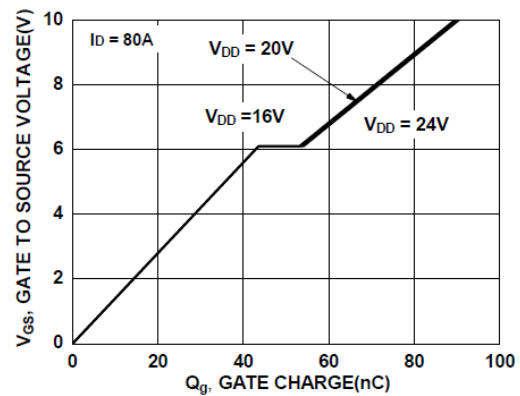
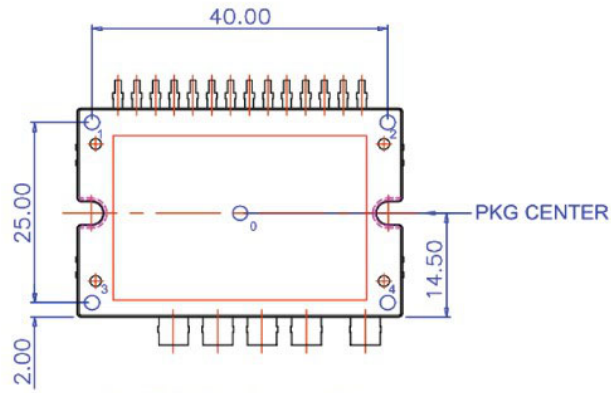

Figure 14. Gate Charge vs. Gate-to-Source Voltage



# NXV04V120DB1



FLATNESS: MAX. 150um

-. MEASURING AT INDICATING POINTS  
1, 2, 3, AND 4 (BASED ON "0")

**Figure 15. Flatness Measurement Position**

## MECHANICAL CHARACTERISTICS AND RATINGS

Parameter	Test Conditions	Min.	Typ.	Max.	Units
Device Flatness	Refer to the package dimensions	0	-	150	um
Mounting Torque	Mounting screw: M3, recommended 0.7 N•m	0.4	-	0.8	N•m
Weight		-	20	-	g

# MECHANICAL CASE OUTLINE

## PACKAGE DIMENSIONS

ON Semiconductor®



### 19LD, APM, PDD STD (APM19-CBC) CASE MODCD ISSUE O

DATE 30 NOV 2016

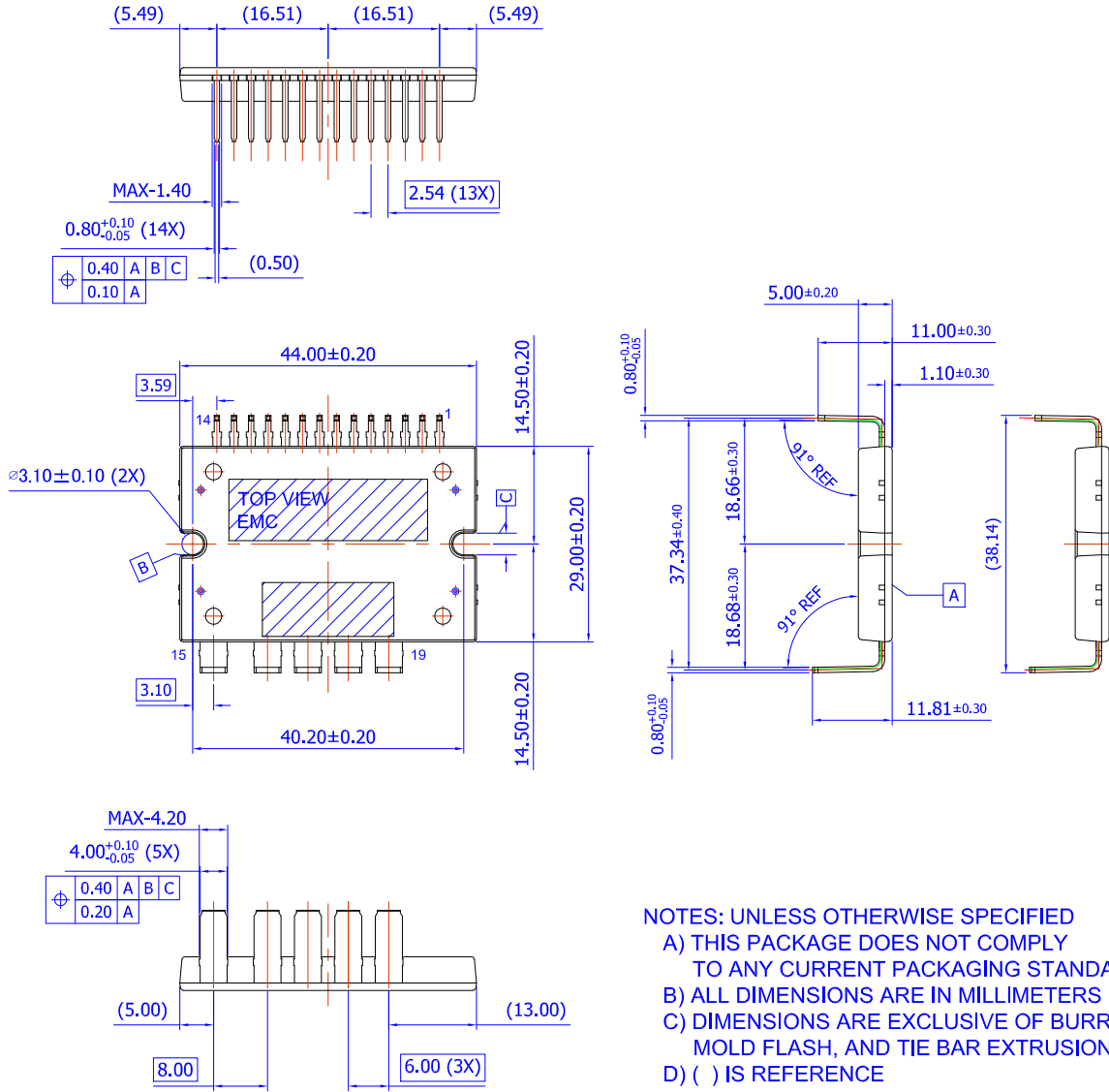

<b>DOCUMENT NUMBER:</b>	<b>98AON13505G</b>	Electronic versions are uncontrolled except when accessed directly from the Document Repository. Printed versions are uncontrolled except when stamped "CONTROLLED COPY" in red.
<b>DESCRIPTION:</b>	<b>19LD, APM, PDD STD (APM19-CBC)</b>	<b>PAGE 1 OF 1</b>

ON Semiconductor and are trademarks of Semiconductor Components Industries, LLC dba ON Semiconductor or its subsidiaries in the United States and/or other countries. ON Semiconductor reserves the right to make changes without further notice to any products herein. ON Semiconductor makes no warranty, representation or guarantee regarding the suitability of its products for any particular purpose, nor does ON Semiconductor assume any liability arising out of the application or use of any product or circuit, and specifically disclaims any and all liability, including without limitation special, consequential or incidental damages. ON Semiconductor does not convey any license under its patent rights nor the rights of others.

ON Semiconductor and  are trademarks of Semiconductor Components Industries, LLC dba ON Semiconductor or its subsidiaries in the United States and/or other countries. ON Semiconductor owns the rights to a number of patents, trademarks, copyrights, trade secrets, and other intellectual property. A listing of ON Semiconductor's product/patent coverage may be accessed at [www.onsemi.com/site/pdf/Patent-Marking.pdf](http://www.onsemi.com/site/pdf/Patent-Marking.pdf). ON Semiconductor reserves the right to make changes without further notice to any products herein. ON Semiconductor makes no warranty, representation or guarantee regarding the suitability of its products for any particular purpose, nor does ON Semiconductor assume any liability arising out of the application or use of any product or circuit, and specifically disclaims any and all liability, including without limitation special, consequential or incidental damages. Buyer is responsible for its products and applications using ON Semiconductor products, including compliance with all laws, regulations and safety requirements or standards, regardless of any support or applications information provided by ON Semiconductor. "Typical" parameters which may be provided in ON Semiconductor data sheets and/or specifications can and do vary in different applications and actual performance may vary over time. All operating parameters, including "Typicals" must be validated for each customer application by customer's technical experts. ON Semiconductor does not convey any license under its patent rights nor the rights of others. ON Semiconductor products are not designed, intended, or authorized for use as a critical component in life support systems or any FDA Class 3 medical devices or medical devices with a same or similar classification in a foreign jurisdiction or any devices intended for implantation in the human body. Should Buyer purchase or use ON Semiconductor products for any such unintended or unauthorized application, Buyer shall indemnify and hold ON Semiconductor and its officers, employees, subsidiaries, affiliates, and distributors harmless against all claims, costs, damages, and expenses, and reasonable attorney fees arising out of, directly or indirectly, any claim of personal injury or death associated with such unintended or unauthorized use, even if such claim alleges that ON Semiconductor was negligent regarding the design or manufacture of the part. ON Semiconductor is an Equal Opportunity/Affirmative Action Employer. This literature is subject to all applicable copyright laws and is not for resale in any manner.

## PUBLICATION ORDERING INFORMATION

### LITERATURE FULFILLMENT:

Email Requests to: [orderlit@onsemi.com](mailto:orderlit@onsemi.com)

ON Semiconductor Website: [www.onsemi.com](http://www.onsemi.com)

### TECHNICAL SUPPORT

North American Technical Support:  
Voice Mail: 1 800-282-9855 Toll Free USA/Canada  
Phone: 011 421 33 790 2910

Europe, Middle East and Africa Technical Support:

Phone: 00421 33 790 2910

For additional information, please contact your local Sales Representative

