

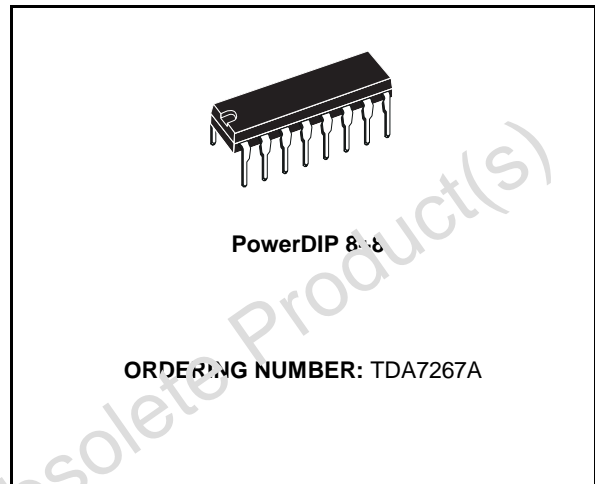

# TDA7267A

## 3W MONO AMPLIFIER

- CAN DELIVER 3W THD 10% 14.5V/8Ω
- INTERNAL FIXED GAIN 32dB
- NO FEEDBACK CAPACITOR
- NO BOUCHEROT CELL
- THERMAL PROTECTION
- AC SHORT CIRCUIT PROTECTION
- SVR CAPACITOR FOR BETTER RIPPLE REJECTION
- LOW TURN-ON/OFF POP
- STAND-BY MODE



### DESCRIPTION

The device TDA7267A is a new technology Mono Audio Amplifier in PowerDIP package specifically designed for TV application.

Thanks to the fully complementary output configura-

tion the device delivers a rail to rail voltage swing without need of bootstrap capacitors.

### BLOCK DIAGRAM

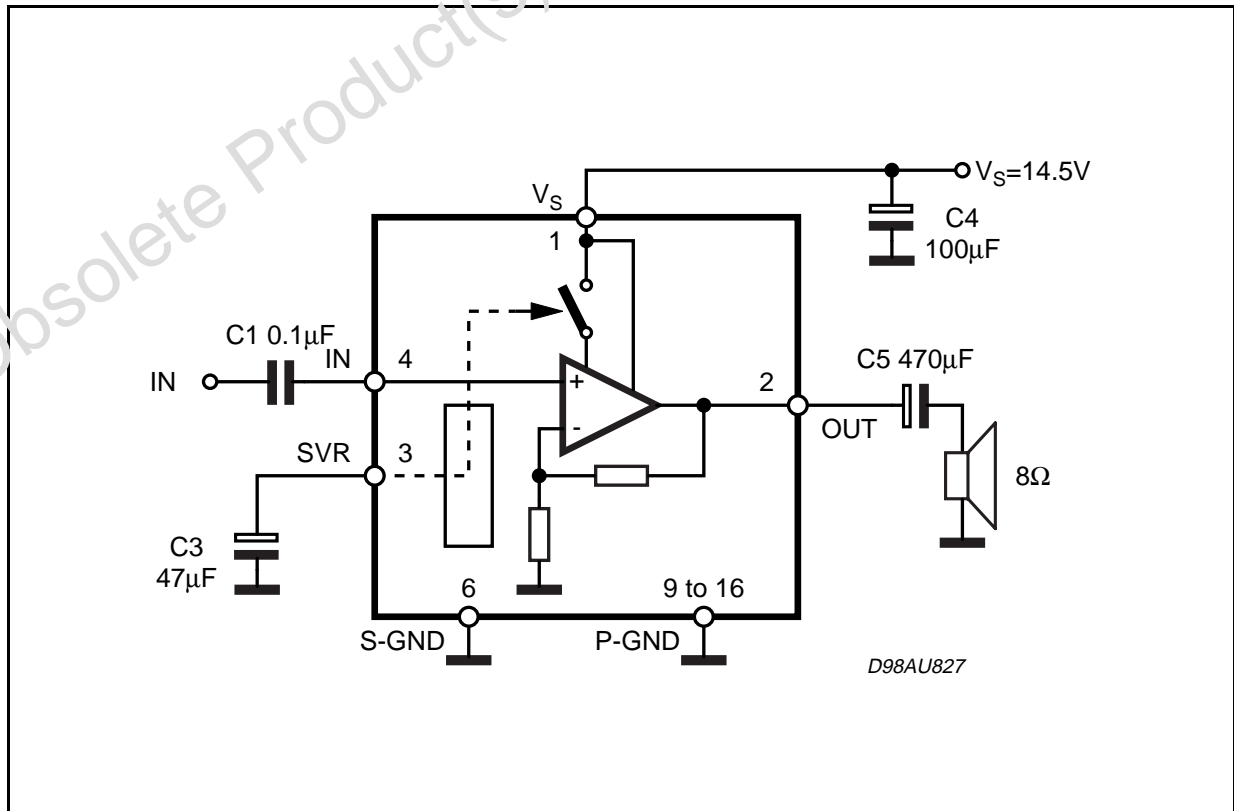

# TDA7267A

## ABSOLUTE MAXIMUM RATINGS

Symbol	Parameter	Value	Unit
$V_S$	Operating Supply Voltage	18	V
$I_o$	Output Put Peak Current	1.5	A
$T_{op}$	Operating Temperature Range	0 to 70	°C
$T_j$	Junction Temperature	150	°C
$T_{stg}$	Storage Temperature Range	-40 to 125	°C

## PIN CONNECTION (Top view)

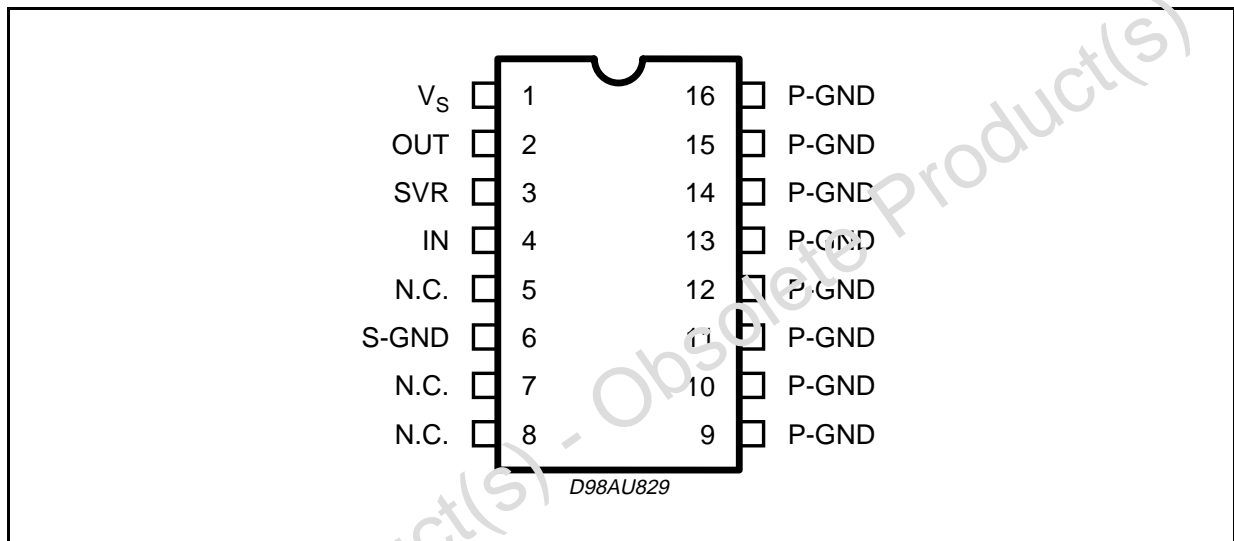

Rth with "on Board" Square Heat Sink vs. Copper Area

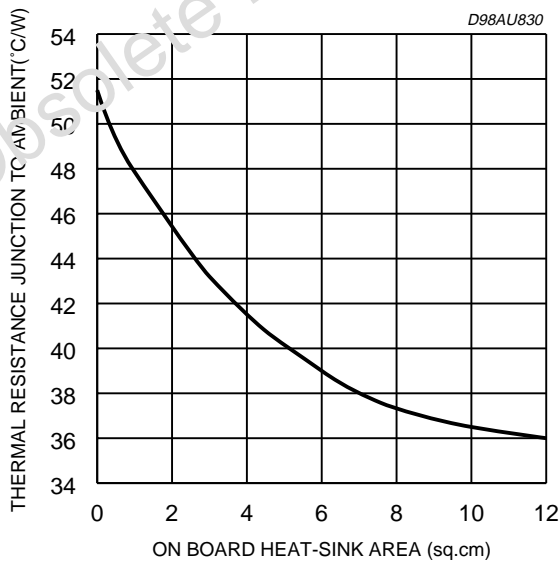

Example of heatsink using PC board copper

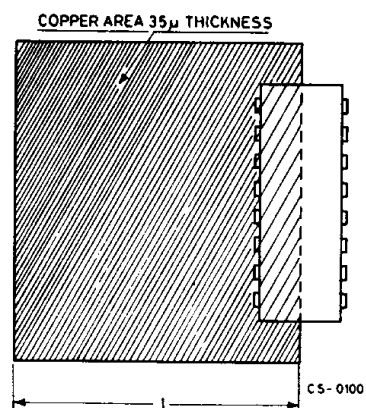

**THERMAL DATA**

Symbol	Parameter	Value	Unit
R <sub>th j-amb</sub>	Thermal Resistance Junction to ambient	70	°C/W
R <sub>th j-case</sub>	Thermal Resistance Junction to case	15	°C/W

**ELECTRICAL CHARACTERISTICS** (T<sub>amb</sub> = 25°C; V<sub>S</sub> = 14.5V; R<sub>L</sub> = 8Ω; f = 1KHz; unless otherwise specified.)

Symbol	Parameter	Test Condition	Min.	Typ.	Max.	Unit
V <sub>S</sub>	Supply Voltage Range		5		18	V
I <sub>S</sub>	Quiescent Current			23	35	mA
I <sub>sb</sub>	Stand-By Current	Pin 3 shorted to GND			0.3	nA
V <sub>O</sub>	Quiescent Output Voltage			7.5		V
A <sub>V</sub>	Voltage Gain		31		33	dB
R <sub>IN</sub>	Input Impedance		50	∞		KΩ
P <sub>O</sub>	Output Power	THD = 10%	2.7	3		W
THD	Distortion	P <sub>O</sub> = 1W		0.1	0.3	%
SVR	Supply Voltage Rejection	V <sub>ripple</sub> = 150mVrms; F <sub>ripple</sub> = 1KHz		50		dB
E <sub>I</sub>	Input Noise Voltage	R <sub>g</sub> = 10KΩ; BW = 20Hz to 20KHz		5	10	μV
V <sub>sb</sub>	Stand-By Enable Voltage				1	V

**Figure 1. Application Circuit**

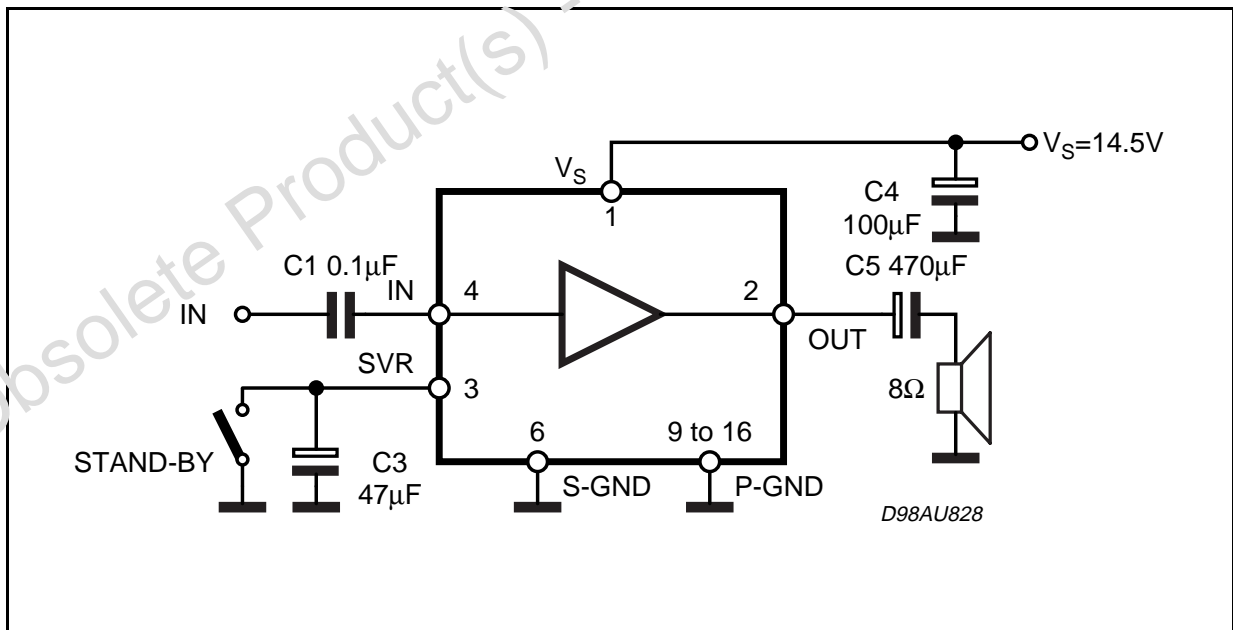

**APPLICATION HINTS:**

For 14.5V supply and 8Ω speaker application, its maximum power dissipation is about 1.8W.

Assuming that max ambient temperature is 70°C, the required thermal resistance of the device mounted on the PCB with a dissipating area

must be equal to:  $(150 - 70)/1.8 = 44.4^{\circ}\text{C/W}$ .

Junction to pin thermal resistance of the package is about 15°C/W. That means external heat sink of about 30°C/W is required.

Cu ground plane of PCB can be used as heat dissipating means.

Figure 2. PCB And Components Layout Of The Application Circuit of Figure 1

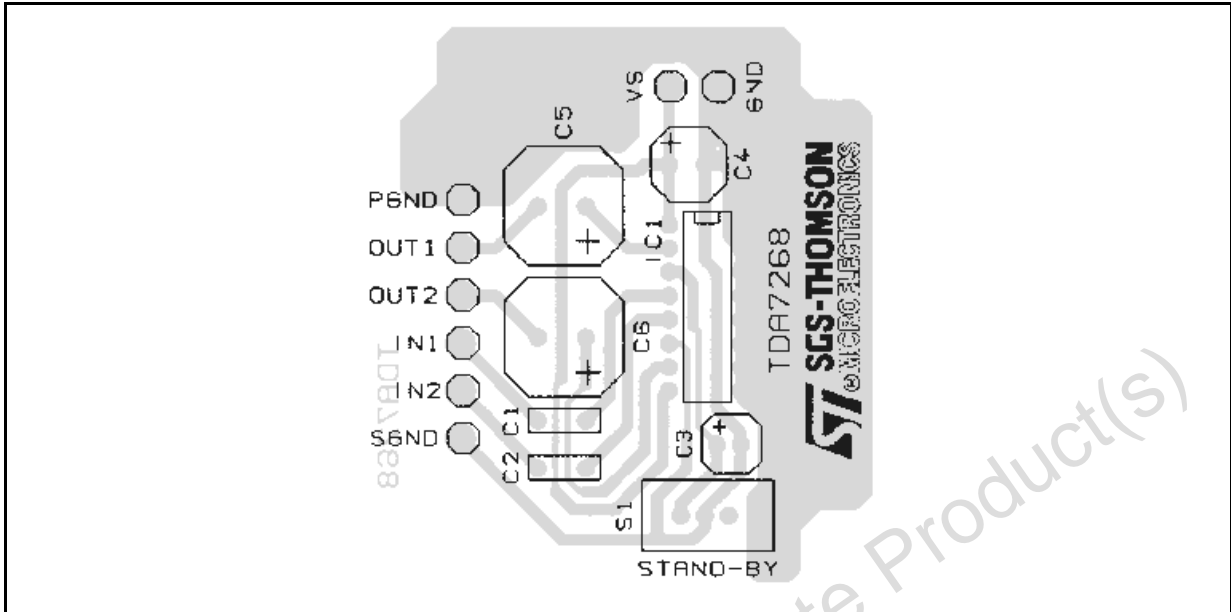

Components C2 and C6 must be ignored.

Figure 3. Distortion vs Output Power

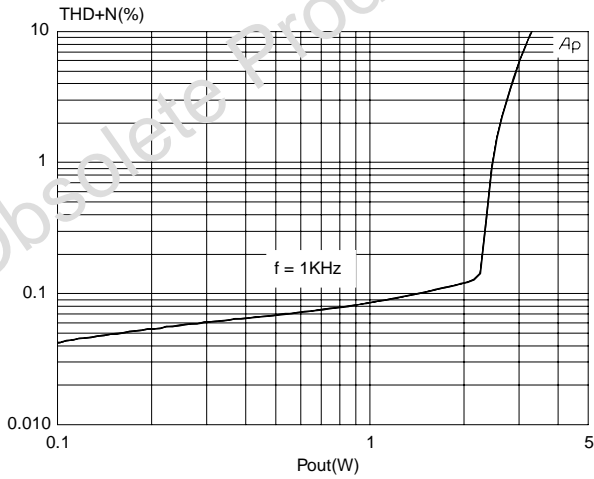
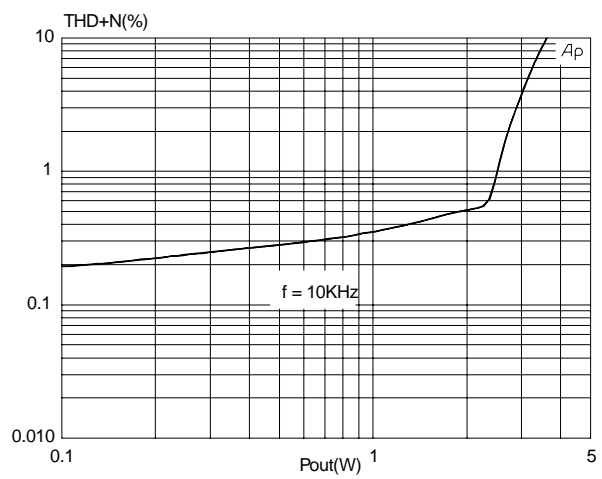

Figure 4. Distortion vs Output Power



Remark: all the characterization curves refer to the electrical test conditions.

Figure 5. Distortion vs Output Power

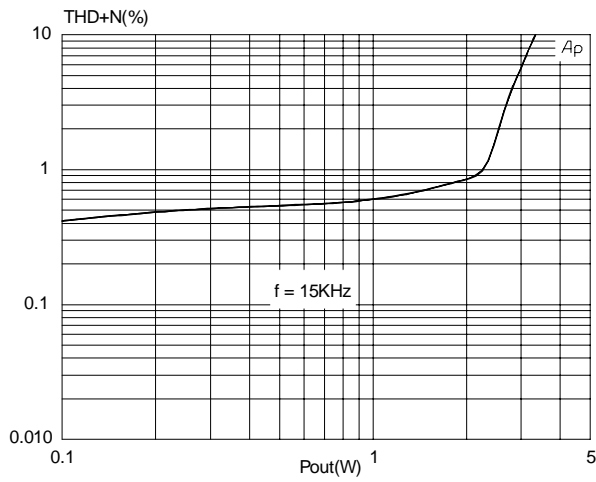

Figure 6. Output Power vs Supply Voltage

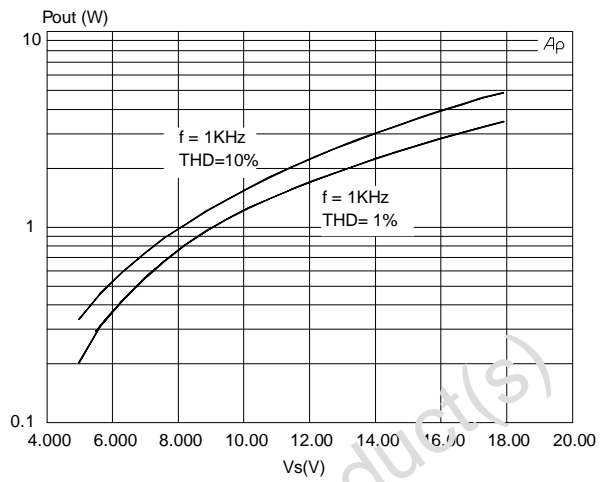

Figure 7. Distortion vs Frequency

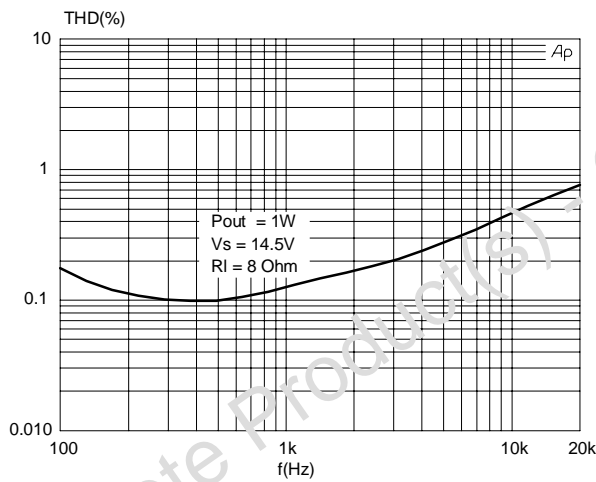

Figure 8. Quiescent current vs Supply Voltage

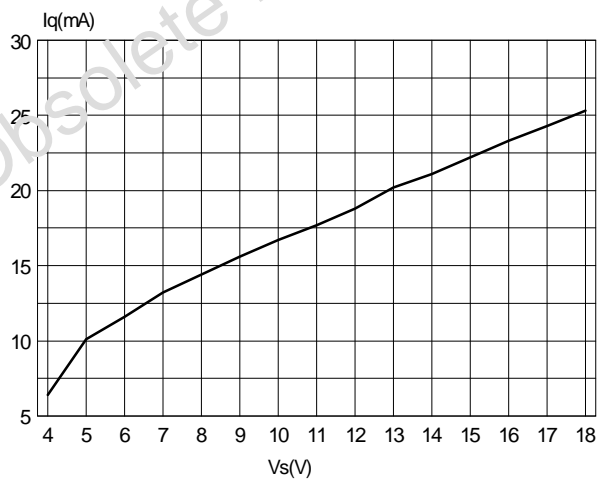
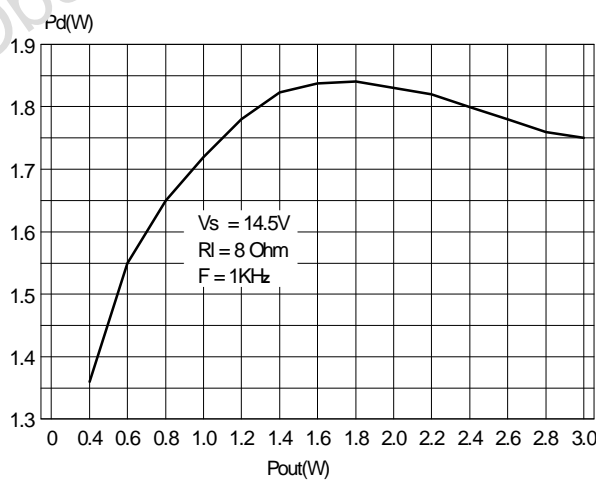
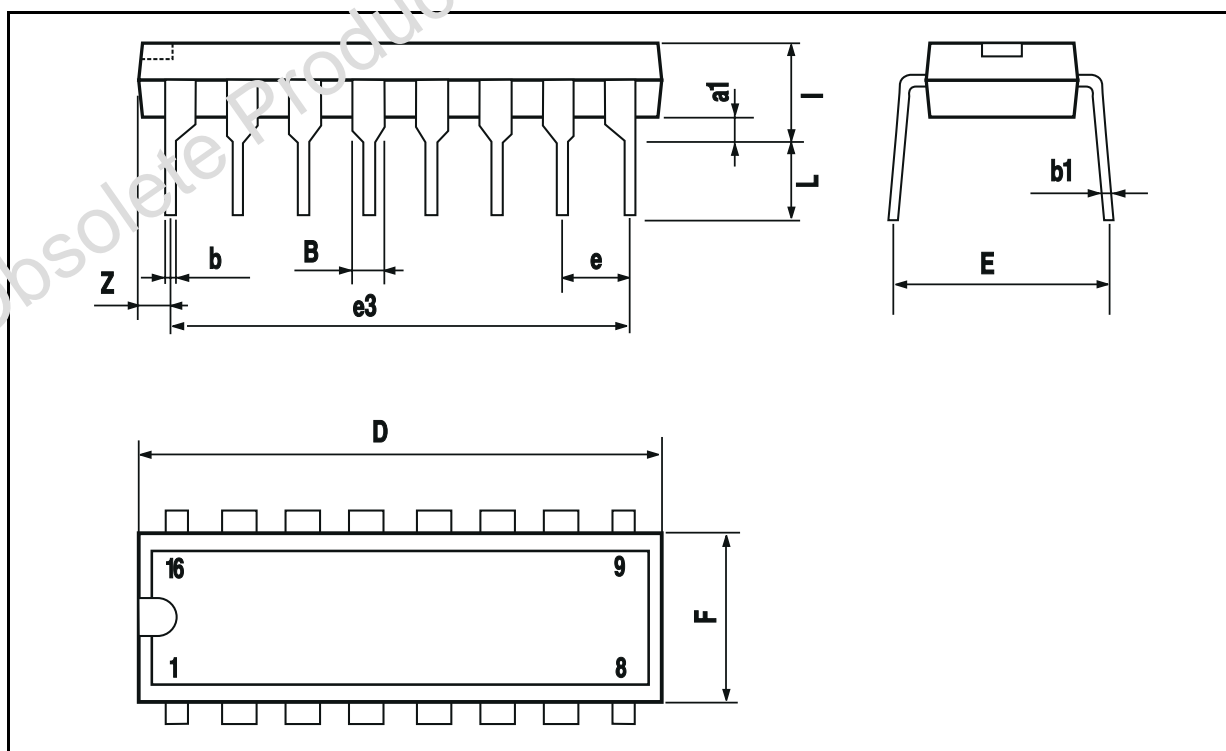

Figure 9. Power dissipation vs Output Power



POWERDIP 8+8 PACKAGE MECHANICAL DATA

DIM.	mm			inch		
	MIN.	TYP.	MAX.	MIN.	TYP.	MAX.
a1	0.51			0.020		
B	0.77		1.65	0.030		0.065
b		0.5			0.020	
b1		0.25			0.010	
D			20			0.787
E		8.5			0.335	
e		2.54			0.100	
e3		17.78			0.700	
F			7.1			0.280
I			5.1			0.201
L		3.3			0.130	
Z			1.27			0.050



Obsolete Product(s) - Obsolete Product(s)

Information furnished is believed to be accurate and reliable. However, STMicroelectronics assumes no responsibility for the consequences of use of such information nor for any infringement of patents or other rights of third parties which may result from its use. No license is granted by implication or otherwise under any patent or patent rights of STMicroelectronics. Specification mentioned in this publication are subject to change without notice. This publication supersedes and replaces all information previously supplied. STMicroelectronics products are not authorized for use as critical components in life support devices or systems without express written approval of STMicroelectronics.

The ST logo is a registered trademark of STMicroelectronics  
© 1998 STMicroelectronics – Printed in Italy – All Rights Reserved  
STMicroelectronics GROUP OF COMPANIES

Australia - Brazil - Canada - China - France - Germany - Italy - Japan - Korea - Malaysia - Malta - Mexico - Morocco - The Netherlands - Singapore - Spain - Sweden - Switzerland - Taiwan - Thailand - United Kingdom - U.S.A.

