

## L99DZ100G, L99DZ120 Evaluation Board

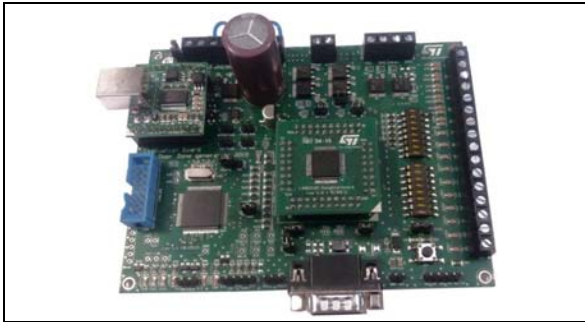

Data brief

### Features

- 1 half bridge for 7.5 A load (RON = 100 mΩ)
- 1 half bridge for 7.5 A load (RON = 150 mΩ)
- 2 half bridges for 0.5 A load (RON = 2000 mΩ) (not present in L99DZ120)
- 2 half bridges for 3 A load (RON = 300 mΩ)
- 1 configurable high-side driver for up to 1.5 A (RON = 500 mΩ) or 0.35 A (RON = 1600 mΩ) load
- 1 configurable high-side driver for 0.8 A (RON = 800 mΩ) or 0.35 A (RON = 1600 mΩ) load
- 3 configurable high-side drivers for 0.15 A/0.35 A (RON = 2 Ω)
- 1 configurable high-side driver for 0.25 A/0.5 A (RON = 2 Ω) to supply EC Glass MOSFET (not present in L99DZ120)
- 4 configurable HS drivers for 0.15A/0.25A (RON = 5 Ω)
- Internal 10bit PWM timer for each stand-alone HS driver
- Buffered supply for voltage regulators and 2 high-side drivers (OUT15 & OUT\_HS / both P-channel) to supply e.g. external contacts
- Programmable soft-start function to drive loads with higher inrush currents as current limitation

value (for OUT1-6, OUT7, OUT8 and OUT\_HS) with thermal expiration feature

- Control block for electro-chromic element (not present in L99DZ120)
- Two 5 V voltage regulators for microcontroller and peripheral supply
- Configurable window watchdog
- LIN 2.2a compliant (SAEJ2602 compatible) transceiver
- Advanced high speed CAN transceiver (ISO 11898-2:2003 /-5:2007 and SAE J2284 compliant) with local failure and bus failure diagnosis and selective wake-up functionality according to ISO 11898-6:2013 (not present in L99DZ120)
- Separated (Isolated) fail-safe block with 2 LS (RON = 1 mΩ) to pull down the gates of the external HS MOSFETs
- Thermal clusters
- A/D conversion of supply voltages and internal temperature sensors
- Embedded and programmable VS duty cycle adjustment for LED driver outputs

Table 1. Device summary

Order code	Reference
EVAL-L99DZ100G	L99DZ100G Mother and Daughter Board
EVAL-D-L99DZ100G	L99DZ100G Daughter Board
EVAL-L99DZ120	L99DZ120 Mother and Daughter Board
EVAL-D-L99DZ120	L99DZ120 Daughter Board

# Contents

- 1 Description ..... 5**
- 2 Application schematics and layouts ..... 6**
  - 2.1 L99DZ100G motherboard ..... 6
- 3 L99DZ100G daughterboard ..... 10**
- 4 Demonstration software ..... 12**
  - 4.1 System requirements ..... 12
- 5 Revision history ..... 13**



## List of tables

Table 1.	Device summary . . . . .	1
Table 2.	Document revision history . . . . .	13

## List of figures

Figure 1.	L99DZ100G motherboard top layer . . . . .	6
Figure 2.	L99DZ100G motherboard bottom layer . . . . .	7
Figure 3.	Motherboard typical application diagram example (1) . . . . .	8
Figure 4.	Motherboard typical application diagram example (2) . . . . .	9
Figure 5.	L99DZ100G Daughterboard top layer . . . . .	10
Figure 6.	L99DZ100G Daughterboard bottom layer . . . . .	10
Figure 7.	L99DZ100G Daughterboard typical application example . . . . .	11

# 1 Description

The EVAL-L99DZ100G and EVAL-L99DZ120 are evaluation boards designed for Door Zone Applications. Both are composed by the same motherboard and they differentiate for the daughter board on which is pre-assembled the L99DZ100G in the EVAL-L99DZ100G case (conceived for front door application) or the L99DZ120 in the EVAL-L99DZ120 case (conceived for rear door applications).

The motherboard, based on STM8 microcontroller, provides the logic section for monitoring and driving the L99DZ100G or the L99DZ120 assembled in the daughterboard.

With aim of making the board usage and settings simpler, ST provides a dedicated and a user-friendly software with a Graphic User Interface (GUI). This enables the user to set L99DZ100G or L99DZ120 parameters and at the same time it shows real time device diagnostic information as the current output evolution, the battery voltage monitoring, the board temperature and much more.

## 2 Application schematics and layouts

### 2.1 L99DZ100G motherboard

Figure 1. L99DZ100G motherboard top layer

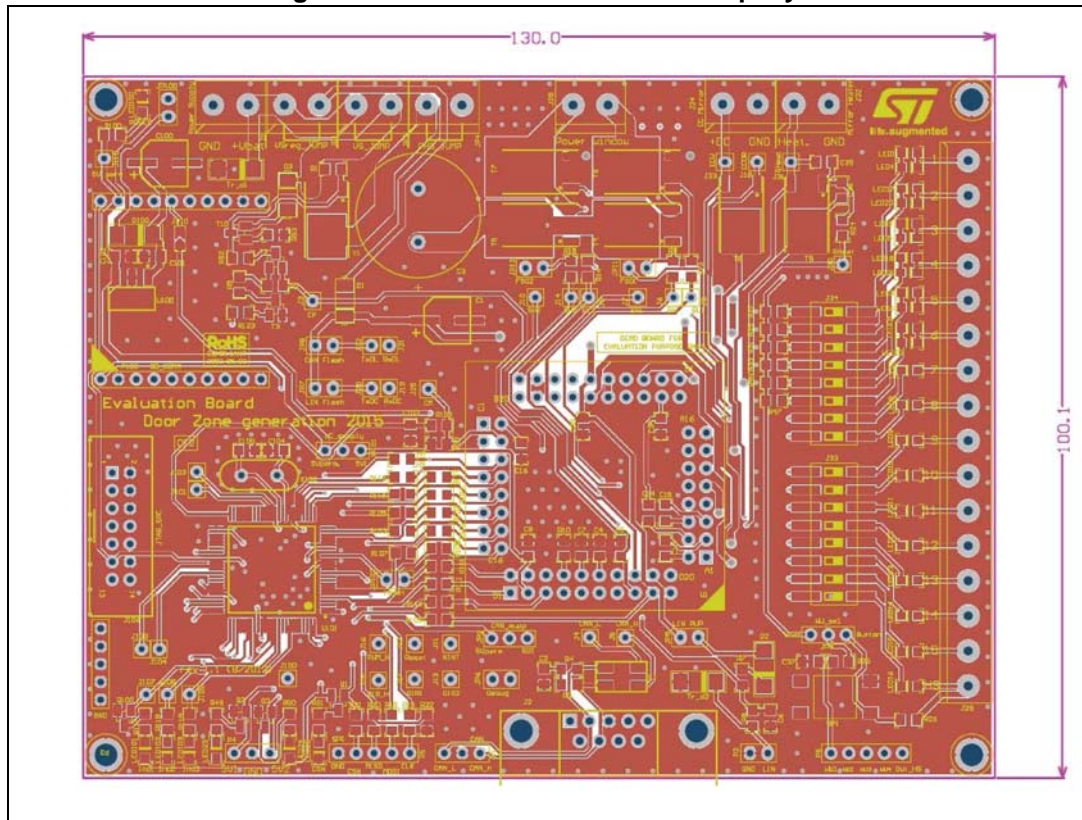

Figure 2. L99DZ100G motherboard bottom layer

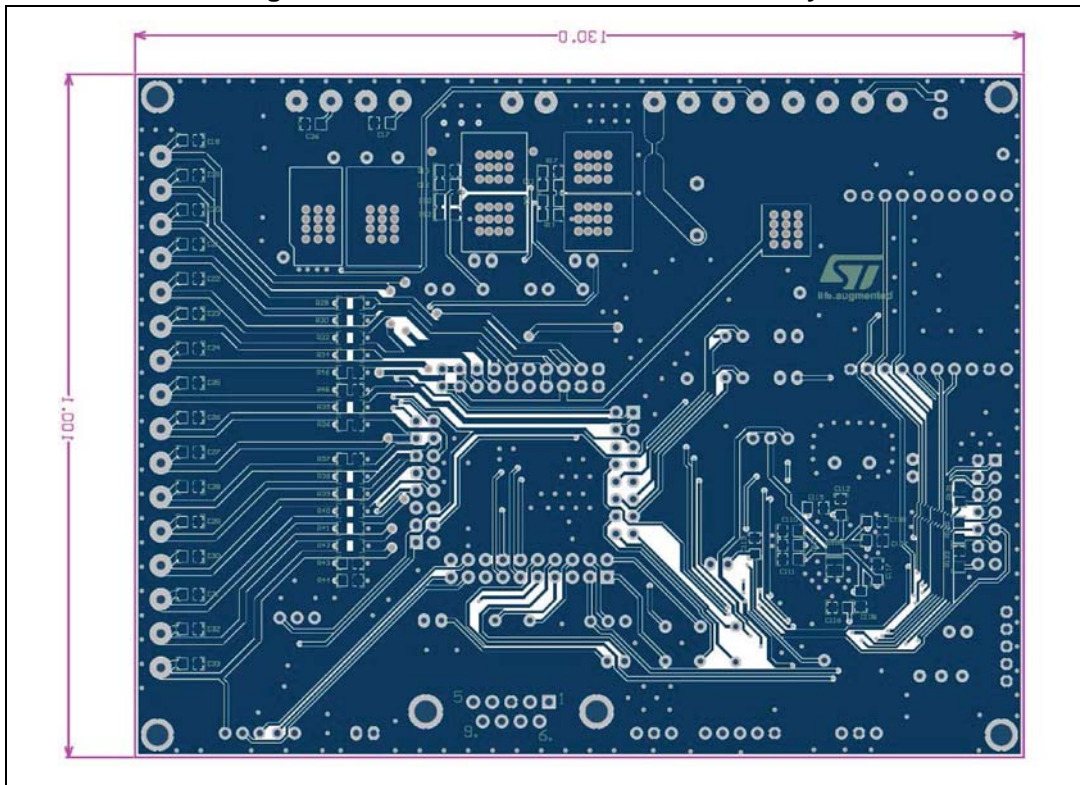



Figure 3. Motherboard typical application diagram example (1)

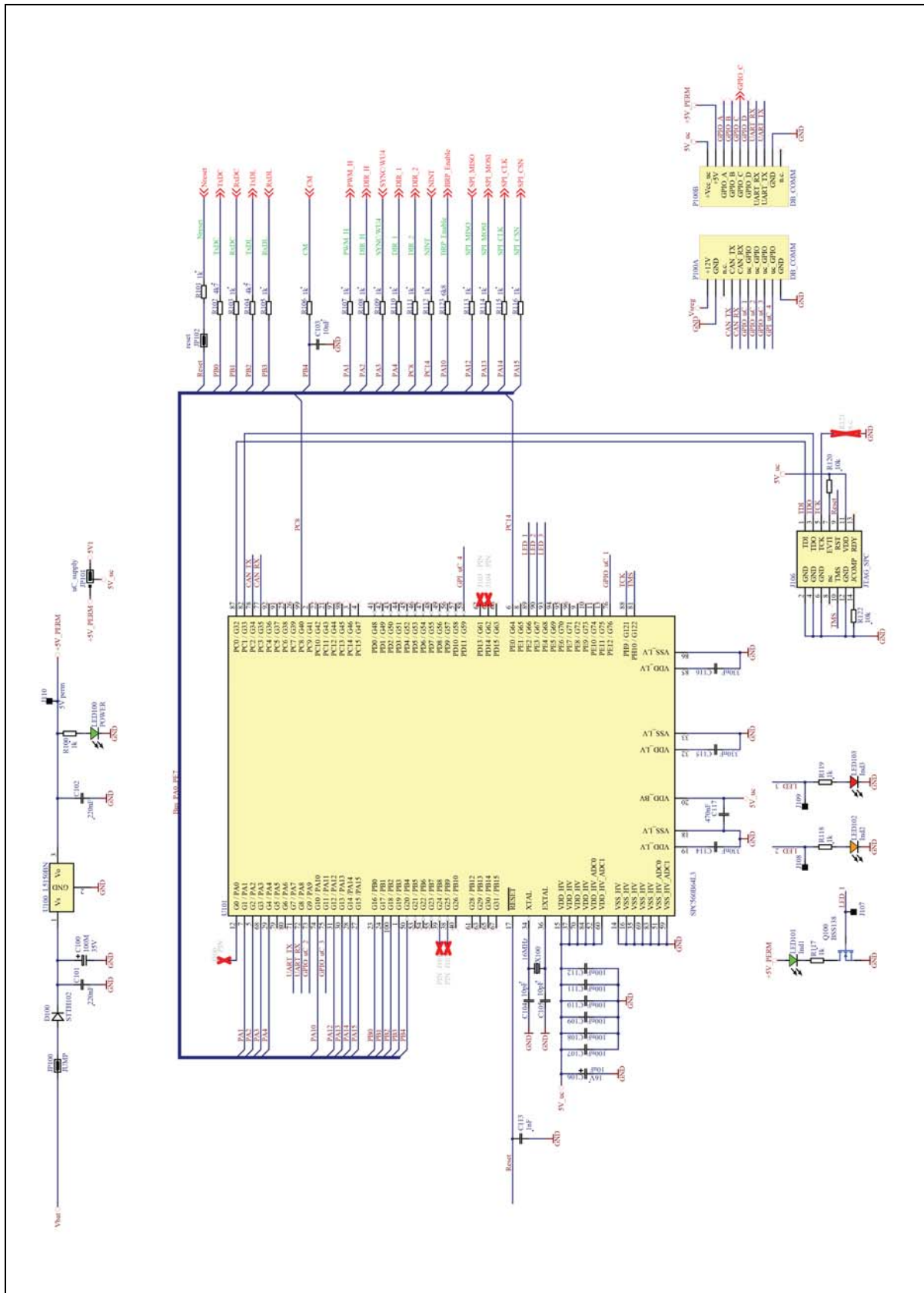
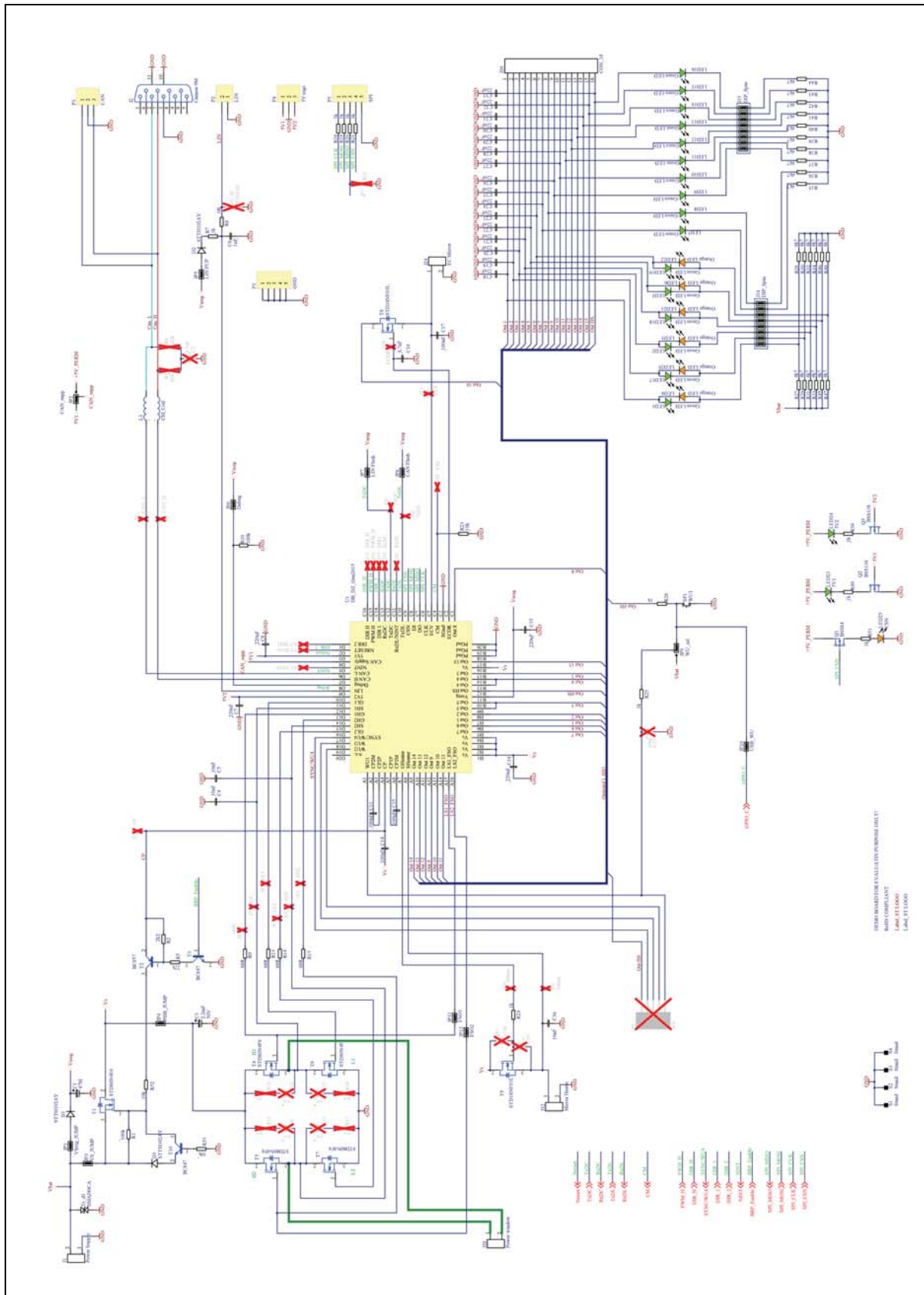



Figure 4. Motherboard typical application diagram example (2)



### 3 L99DZ100G daughterboard

Figure 5. L99DZ100G Daughterboard top layer

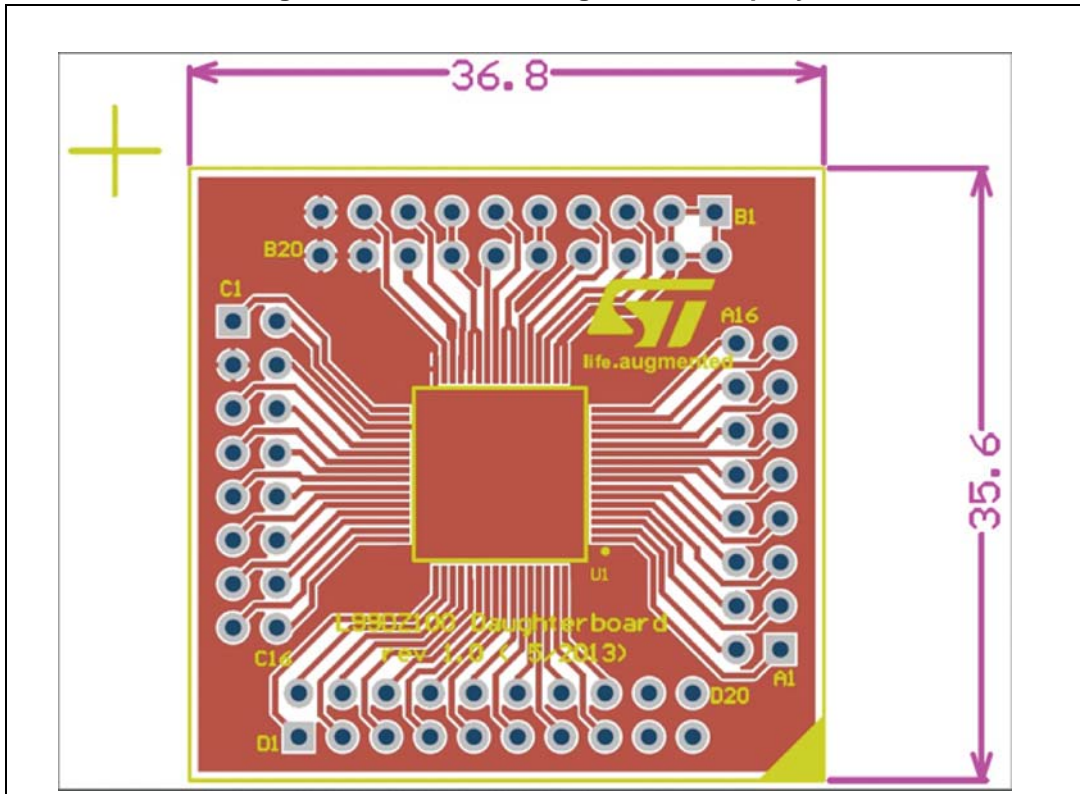

Figure 6. L99DZ100G Daughterboard bottom layer

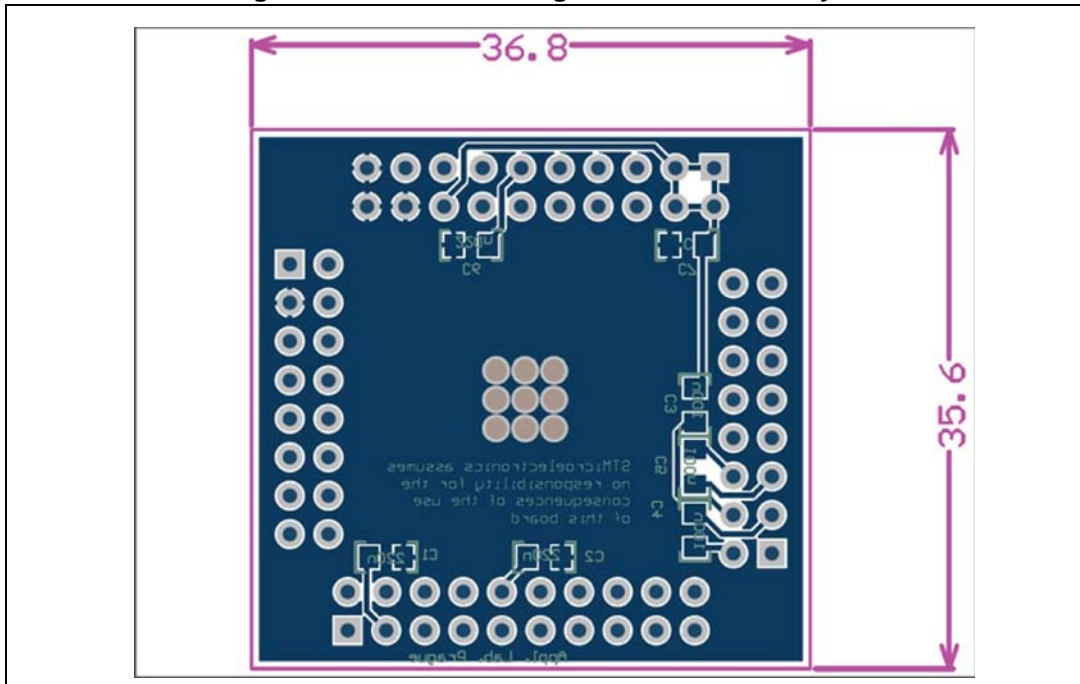
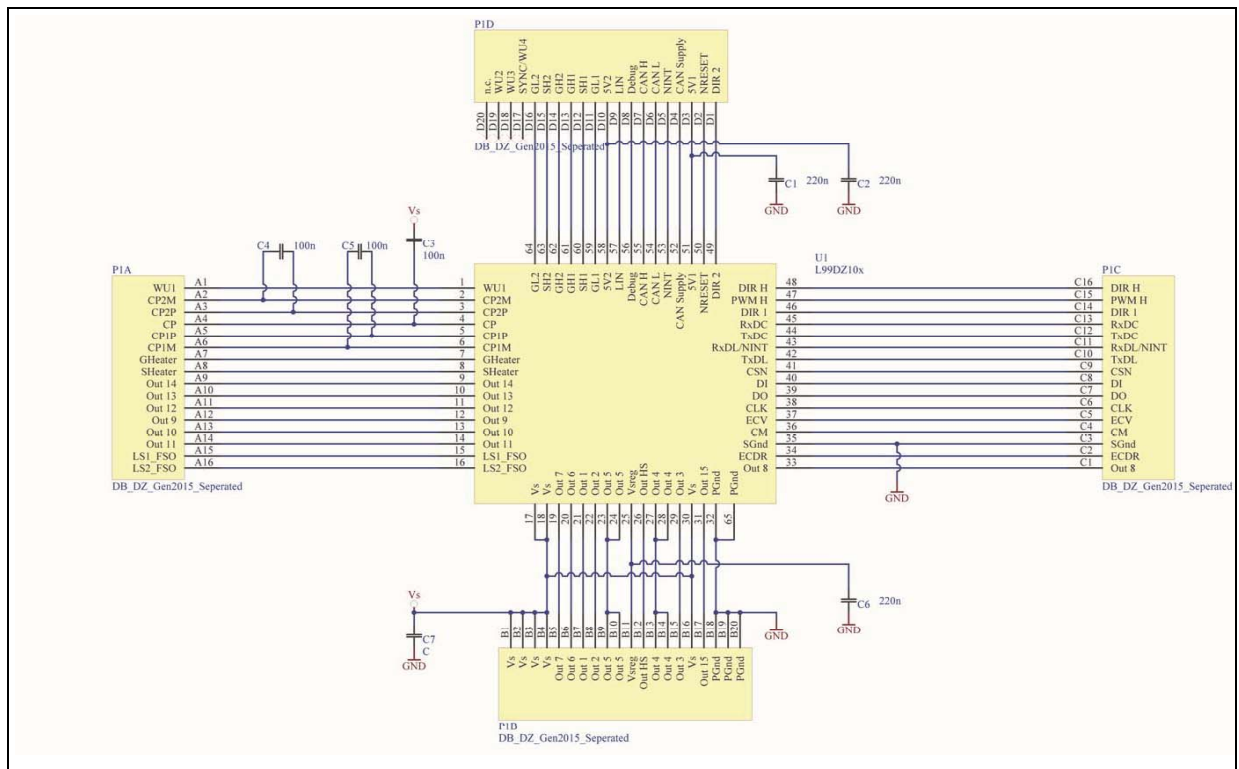

Figure 7. L99DZ100G Daughterboard typical application example



## 4 Demonstration software

A software GUI (Graphical User Interface) for easy demonstration of the L99DZ100G and L99DZ120 features is delivered on customer request.

### 4.1 System requirements

- Windows OS (XP, 7, 8)
- USB type B

## 5 Revision history

Table 2. Document revision history

Date	Revision	Changes
15-Dec-2017	1	Initial release.

**IMPORTANT NOTICE – PLEASE READ CAREFULLY**

STMicroelectronics NV and its subsidiaries ("ST") reserve the right to make changes, corrections, enhancements, modifications, and improvements to ST products and/or to this document at any time without notice. Purchasers should obtain the latest relevant information on ST products before placing orders. ST products are sold pursuant to ST's terms and conditions of sale in place at the time of order acknowledgement.

Purchasers are solely responsible for the choice, selection, and use of ST products and ST assumes no liability for application assistance or the design of Purchasers' products.

No license, express or implied, to any intellectual property right is granted by ST herein.

Resale of ST products with provisions different from the information set forth herein shall void any warranty granted by ST for such product.

ST and the ST logo are trademarks of ST. All other product or service names are the property of their respective owners.

Information in this document supersedes and replaces information previously supplied in any prior versions of this document.

© 2017 STMicroelectronics – All rights reserved