

NCV890430

Synchronous Regulator - Automotive, Step-Down, 100% Duty Cycle

0.6 A, 2 MHz

The NCV890430 is a fixed-frequency Synchronous Buck regulator intended for Automotive, battery-connected applications that operate with up to a 45 V input supply. It is suitable for automotive systems requiring low noise and low shutdown currents that also need to operate at low input voltage close to the output voltage. A reset pin (with adjustable delay) simplifies interfacing with a microcontroller. This part also features an enable input that can either be connected to a low voltage (such as a micro-controller output) or high voltage (such as the battery input), and a synchronization input.

The NCV890430 also provides several protection features expected in automotive power supply systems such as current limit, short circuit protection, and thermal shutdown. In addition, the high switching frequency produces low output voltage ripple even when using small inductor values and all-ceramic input output filter capacitors – forming a space-efficient switching regulator solution.

Features

- Internal 550 mΩ P-channel and 300 mΩ N-channel Power Switches
- Capable of 100% Duty Cycle Operation
- V_{IN} Operating Range 3.5 V to 37 V
- Withstands Load Dump to 45 V
- 2 MHz Free-running Switching Frequency
- Low Shutdown Current < 10 μ A
- High Voltage Enable Pin
- Synchronization Input Pin
- Maximum DC Output Current of at Least 0.6 A
- Fixed Output Voltage (5 V, 3.3 V, 2.5 V Versions)
- $\pm 2\%$ Output Voltage Accuracy
- DFN Package with Wettable Flanks (Pin Edge Plating per JEDEC MO220)
- NCV Prefix for Automotive and Other Applications Requiring Unique Site and Control Change Requirements; AEC-Q100 Qualified and PPAP Capable
- These are Pb-Free Devices

Typical Applications

- Automotive Infotainment and Instrumentation
- Automotive Body Applications
- Linear Regulator Replacement
- Rear View Camera



ON Semiconductor®

www.onsemi.com



DFN8, 3x3, 0.65P
CASE 506CS

PIN CONNECTIONS

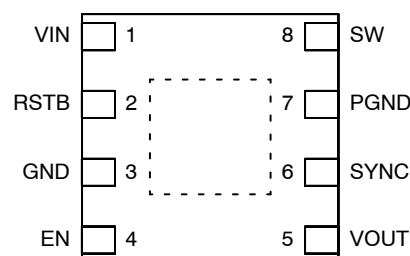

(DFN8 Top View)

MARKING DIAGRAM

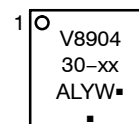

V890430-xx = Specific Device Code
xx = 25, 33 or 50
A = Assembly Location
L = Wafer Lot
Y = Year
W = Work Week
▪ = Pb-Free Package

(Note: Microdot may be in either location)

ORDERING INFORMATION

See detailed ordering, marking and shipping information on page 9 of this data sheet.

Table 1. PIN FUNCTION DESCRIPTIONS

Pin No.	Pin Name	Description
1	VIN	Input voltage from battery. Place an input filter capacitor in close proximity to this pin.
2	RSTB	Reset reporting flag. Open drain output, pulling down to ground when the output voltage is out of regulation. The value of the external pull-up resistor determines the delay time that the Reset is held low.
3	GND	Analog ground reference – should be connected directly to the output capacitor ground and the exposed pad.
4	EN	Enable input. Connecting a “high” voltage (TTL compatible, battery voltage tolerant) to this pin turns on the regulator. A low voltage forces the part into a very low Iq shutdown mode.
5	VOUT	Output voltage sensing for regulation.
6	SYNC	Synchronization input. Connecting an external clock to this pin synchronizes switching to the rising edge of the SYNC signal.
7	PGND	Power ground, connect directly to the input capacitor ground and to the exposed pad.
8	SW	Switching node of the Regulator. Connect the output inductor to this pin.
Exposed Pad	EPAD	Must be connected to GND (pin 3, electrical ground) and to a low thermal resistance path to the ambient temperature environment.

Table 2. ABSOLUTE MAXIMUM RATINGS

Rating	Symbol	Value	Unit
Min/Max Voltage VIN		-0.3 to 45	V
Max Voltage VIN to SW		45	V
Min/Max Voltage SW		-0.7 to 40	V
Min Voltage SW – 20 ns		-3.0	V
Min/Max Voltage EN		-0.3 to 40	V
Min/Max Voltage on SYNC, RSTB		-0.3 to 6	V
Min/Max Voltage VOUT		-0.3 to 18	V
Thermal Resistance, DFN8 Junction-to-Ambient (Note 1)	R _{θJA}	40	°C/W
Storage Temperature Range		-55 to +150	°C
Operating Junction Temperature Range	T _J	-40 to +150	°C
ESD withstand Voltage (Human Body Model)	V _{ESD}	2.0	kV
Moisture Sensitivity	MSL	Level 1	
Peak Reflow Soldering Temperature (Note 1)		260	°C

Stresses exceeding those listed in the Maximum Ratings table may damage the device. If any of these limits are exceeded, device functionality should not be assumed, damage may occur and reliability may be affected.

1. Mounted on 1 sq. in. of a 4-layer PCB with 1 oz. copper thickness.

Table 3. ELECTRICAL CHARACTERISTICS

($V_{IN} = 4.5\text{ V to }28\text{ V}$, $EN = 5\text{ V}$. Min/Max values are valid for the temperature range $-40^{\circ}\text{C} \leq T_J \leq 150^{\circ}\text{C}$ unless noted otherwise, and are guaranteed by test, design or statistical correlation.)

Parameter	Test Conditions	Symbol	Min	Typ	Max	Unit
QUIESCENT CURRENT						
Quiescent Current, Enabled	$V_{IN} = 13.2\text{ V}$, no switching	I_{qEN}		2.0	3.0	mA
Quiescent Current, Shutdown	$V_{IN} = 13.2\text{ V}$, $V_{EN} = 0\text{ V}$, $T_J = 25^{\circ}\text{C}$	I_{qSD}		5.0	8.0	μA
UNDERVOLTAGE LOCKOUT – VIN						
UVLO Start Threshold	V_{IN} Rising	V_{UVLSTT}	4.1		4.5	V
UVLO Stop Threshold	V_{IN} Falling	V_{UVLSTP}	3.2		3.5	V
SOFT-START						
Soft-Start Completion Time		t_{SS}	0.8	1.4	2.0	ms
OUTPUT VOLTAGE						
Output Voltage during Regulation	$100\ \mu\text{A} < I_{OUT} < 0.6\text{ A}$ 5.0 V Option 3.3 V Option 2.5 V Option	V_{OUTreg}	4.9 3.234 2.45	5.0 3.3 2.5	5.1 3.366 2.55	V
OSCILLATOR						
Frequency	$4.5\text{ V} < V_{IN} < 18\text{ V}$ $20\text{ V} < V_{IN} < 28\text{ V}$	f_{SW} $f_{SW(HV)}$	1.8 0.9	2.0 1.0	2.2 1.1	MHz
VBAT OVERVOLTAGE SHUTDOWN MONITOR						
Overvoltage Stop Threshold		V_{OV1SP}	37		40	V
Overvoltage Start Threshold		V_{OV1ST}	34.5			V
Overvoltage Hysteresis		V_{OV1HY}	0.9	1.7	2.5	V
VIN FREQUENCY FOLDBACK MONITOR						
Frequency Foldback Threshold	V_{IN} Rising V_{IN} Falling	V_{FLDUP} V_{FLDDN}	18.4 18		20 19.8	V
Frequency Foldback Hysteresis		V_{FLDHY}	0.2	0.3	0.4	V
PEAK CURRENT LIMIT						
Current Limit Threshold		I_{LIM}	1.5	1.7	1.9	A
Low-Side Current Limit Threshold	$V_{SW} = 13.2\text{ V}$	I_{LIMLS}	1.5	2.1	2.7	A
POWER SWITCHES						
High-Side Switch ON Resistance		$R_{DS(on)-HS}$		550	1000	$\text{m}\Omega$
Low-Side Switch ON Resistance		$R_{DS(on)-LS}$		300	550	$\text{m}\Omega$
Leakage Current V_{IN} to SW	$EN = 0\text{ V}$, $V_{SW} = 0$	I_{LKSWH}			10	μA
Leakage Current SW to GND	$EN = 0\text{ V}$, $V_{SW} = V_{IN}$	I_{LKSWL}			10	μA
Minimum ON Time	Measured at SW Pin 2.5 V Option 3.3 V & 5.0 V Options	t_{ONMIN}	35 45		55 70	ns
Minimum OFF Time when Not 100% Duty Cycle	Measured at SW Pin at $f_{SW} = 2\text{ MHz}$	t_{OFFMIN}		30	50	ns
Non-Overlap Time		t_{NOVLP}		10		ns
SLOPE COMPENSATION						
Ramp Slope (Note 2) (With Respect to Switch Current)	$4.5\text{ V} < V_{IN} < 18\text{ V}$ $20\text{ V} < V_{IN} < 28\text{ V}$	S_{ramp} $S_{ramp(HV)}$	1.05 0.45	1.5 0.70	1.95 0.95	$\text{A}/\mu\text{s}$

NCV890430

Table 3. ELECTRICAL CHARACTERISTICS (continued)

($V_{IN} = 4.5\text{ V to }28\text{ V}$, $EN = 5\text{ V}$. Min/Max values are valid for the temperature range $-40^{\circ}\text{C} \leq T_J \leq 150^{\circ}\text{C}$ unless noted otherwise, and are guaranteed by test, design or statistical correlation.)

Parameter	Test Conditions	Symbol	Min	Typ	Max	Unit
-----------	-----------------	--------	-----	-----	-----	------

SHORT CIRCUIT FREQUENCY FOLDBACK

Switching Frequency in Short-Circuit Condition						kHz
Lowest Foldback Frequency	$V_{OUT} = 0\text{ V}$, $4.5\text{ V} < V_{IN} < 18\text{ V}$	f_{SWAF}	450	550	650	
Lowest Foldback Frequency – High V_{IN}	$V_{OUT} = 0\text{ V}$, $20\text{ V} < V_{IN} < 28\text{ V}$	f_{SWAFHV}	225	275	325	

HICCUP MODE

Hiccup Mode	$V_{SW} = 0\text{ V}$, no switching	f_{SWHIC}	24	32	40	kHz
Hiccup Mode 2 – SW Short to Battery	$V_{SW} = 13.2\text{ V}$	$f_{SWHICLS}$	24	32	40	kHz

SYNCHRONIZATION

SYNC Input Resistance to Ground	$V_{SYNC} = 5.0\text{ V}$	$R_{H(SYNC)}$	50		200	k Ω
SYNC Input High Threshold Voltage		V_{HSYNC}	2.0			V
SYNC Input Low Threshold Voltage		V_{LSYNC}			0.8	V
SYNC High Pulse Width	$V_{SYNC} > \max V_{HSYNC}$	t_{HSYNC}	40			ns
SYNC Low Pulse Width	$V_{SYNC} < \min V_{LSYNC}$	t_{LSYNC}	40			ns
External SYNC Frequency	2.5 V Option 3.3 V & 5.0 V Options	f_{SYNC}	1.8 1.8		2.2 2.5	MHz
Master Reassertion Time	Time from Last Rising SYNC Edge to First Un-synchronized Turn-on.	$t_{I(SYNC)}$		650		ns

RESET

Reset Threshold	V_{OUT} Decreasing V_{OUT} Increasing	K_{RES_LO} K_{RES_HI}	91 91.5	93	95 97	%
Reset Hysteresis (Ratio of V_{OUT})		K_{RES_HYS}	0.5			%
Leakage Current into RSTB Pin					1.0	μA
Noise-Filtering Delay	From $V_{OUT} < V_{RESET}$ to RSTB Pin Going Low	t_{RES_FLT}	10		25	μs
Reset Delay Time	$I_{RSTB} = 1.1\text{ mA}$ $I_{RSTB} = 500\text{ }\mu\text{A}$ $I_{RSTB} = 100\text{ }\mu\text{A}$	t_{RESET}	4.0 19	1.0 5.0 24	6.0 29	μs ms ms
Reset Delay Modes	Power Good Mode (No Delay) Delay Mode		1000		600	μA
Reset Output Low Level	$I_{RSTB} = 1.2\text{ mA}$	V_{RESL}			0.4	V

ENABLE

Logic Low Threshold Voltage		V_{ENlow}			0.8	V
Logic High Threshold Voltage		V_{ENhigh}	2.0			V
EN Pin Input Current		I_{ENbias}	8.0		30	μA

THERMAL SHUTDOWN

Thermal Shutdown Activation Temperature (Note 2)		T_{SD}	155		190	$^{\circ}\text{C}$
Thermal Shutdown Hysteresis (Note 2)		T_{HYS}	5.0		20	$^{\circ}\text{C}$

Product parametric performance is indicated in the Electrical Characteristics for the listed test conditions, unless otherwise noted. Product performance may not be indicated by the Electrical Characteristics if operated under different conditions.

2. Not tested in production. Limits are guaranteed by design.

TYPICAL CHARACTERISTICS

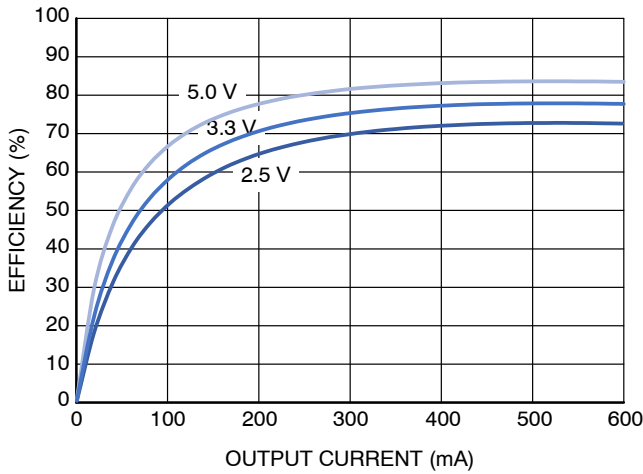

Figure 3. Measured Efficiency vs. Output Current for 12 V Input Voltage*

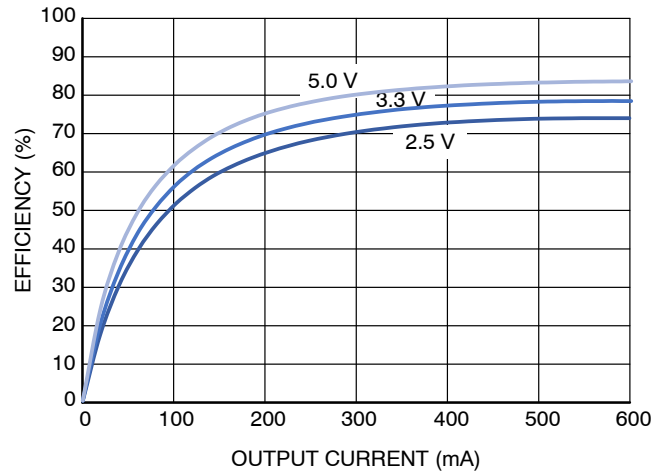

Figure 4. Measured Efficiency vs. Output Current In Frequency Foldback - 20 V Input Voltage*

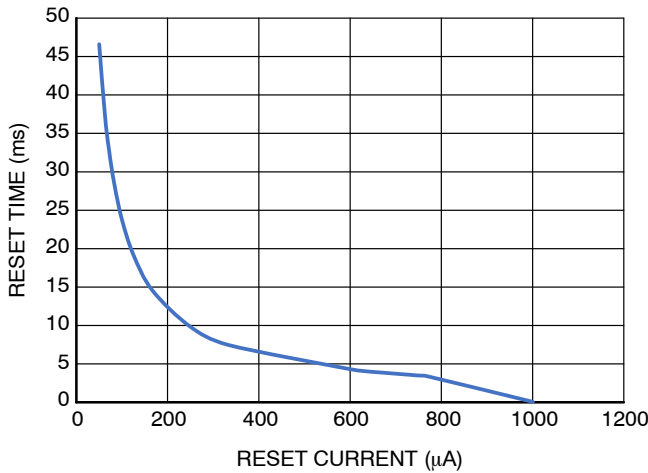

Figure 5. Measured Reset Time vs. Reset Current**

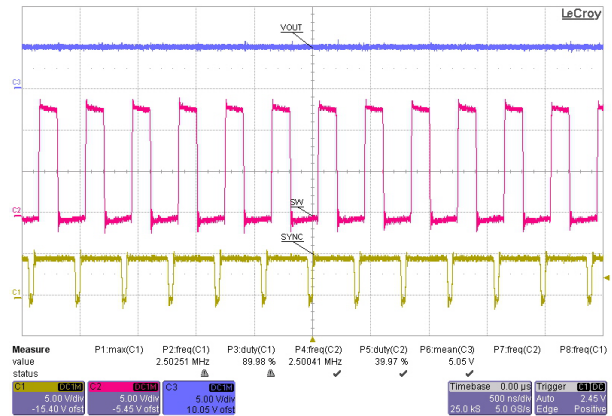

Figure 6. Synchronization with 90% Duty, 2.5 MHz Signal at SYNC Pin

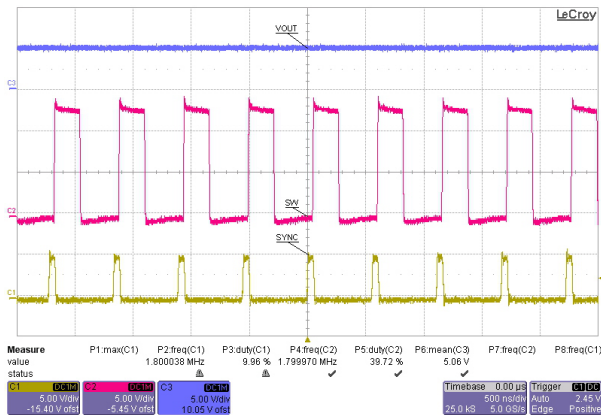

Figure 7. Synchronization with 10% Duty, 1.8 MHz Signal at SYNC Pin

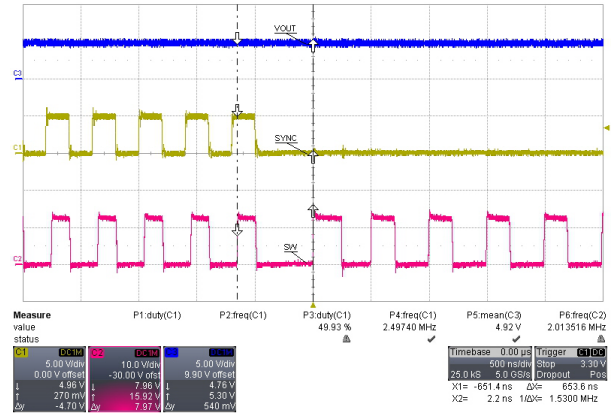

Figure 8. Master Reassertion Time when 2.5 MHz SYNC Signal Disconnected**

*Efficiency Measurements completed with NCV890430 Demo Board and Bourns SRP4020TA-4R7M Inductor.

**Measurements completed with NCV890430 Demo board populated according to the Bill of Materials unless otherwise stated.

APPLICATION INFORMATION

General Description

The NCV890430 is a high-frequency synchronous switch-mode regulator with current-mode control, fixed output voltage and fixed internal closed-loop compensation, accepting a wide input voltage range typical to automotive applications.

The use of a P-channel high-side MOSFET simplifies the driving scheme (no bootstrap circuitry needed), and enables a duty cycle of 100% for low dropout operation at low input voltage.

Input Voltage

An Undervoltage Lockout (UVLO) circuit monitors the input, and can inhibit switching and reset the soft-start circuit if there is insufficient voltage for proper regulation. Depending on the output conditions (voltage option and loading), the NCV890430 may lose regulation and run in drop-out mode before reaching the UVLO threshold: refer to the Minimum V_{IN} calculation tool for details. When the input voltage drops low enough that the part cannot regulate

because it reaches its maximum duty cycle, the high-side MOSFET can turn on permanently (100% duty cycle operation), to help lower the minimum voltage at which the regulator loses regulation.

An overvoltage monitoring circuit automatically terminates switching and disables the output if the input voltage exceeds 37 V (see Figure 9), but the NCV890430 can withstand input voltages up to 45 V.

To avoid skipping switching pulses and entering an uncontrolled mode of operation, the switching frequency is reduced by a factor of 2 when the input voltage exceeds the V_{IN} Frequency Foldback threshold (see Figure 9 below). Frequency reduction is automatically terminated when the input voltage drops back below the V_{IN} Frequency Foldback threshold. This also helps to limit the power lost in switching and generating the drive voltage for the Power Switches at high input voltage. Above the frequency foldback threshold, improved efficiency can be expected due to the lower switching frequency.

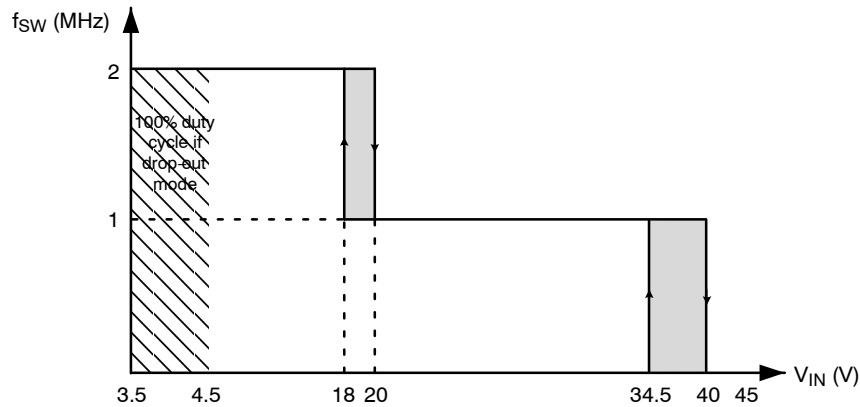

Figure 9. NCV890430 Worst-Case Switching Frequency Profile vs. Input Voltage

Soft-Start

Upon being enabled or released from a fault condition, a soft-start circuit ramps the switching regulator error amplifier reference voltage to the final value, forcing the output to follow the same soft-start ramp. During soft-start, the average switching frequency is lower until the output voltage approaches regulation.

Slope Compensation

A fixed slope compensation signal is generated internally and added to the sensed current to avoid increased output voltage ripple due to bifurcation of inductor ripple current at duty cycles above 50%. The fixed amplitude of the slope compensation signal requires the inductor to be greater than a minimum value, depending on output voltage, in order to

avoid sub-harmonic oscillations. The recommended inductor value is between 1.8 and 3.3 μ H, although other values are possible.

Short Circuit Protection

During severe output overloads or short circuits, the NCV890430 automatically reduces its switching frequency. This creates duty cycles small enough to limit the peak current in the power components, while maintaining the ability to automatically reestablish the output voltage if the overload is removed.

In more severe short-circuit conditions where the inductor current reaches the peak current limit during the minimum on time, the regulator enters a hiccup mode that further reduces the power dissipation and protects the system.

RESET Function

The RSTB pin is pulled low when the output voltage falls below 7% of the nominal regulation level, and floats when the output is properly regulated. A pull-up resistor tied to the output is needed to generate a logic high signal on this open-drain pin. The pin can be left unconnected when not used.

When the output voltage drops out of regulation, the pin goes low after a short noise-filtering delay (t_{RES_FILT}). After the output goes back to regulation, the RSTB pin stays low for an adjustable delay time, simplifying the connection to a micro-controller.

The RSTB signal can either be used as a reset with delay or a power good (no delay). The adjustable delay is determined by the current into the RSTB pin, set by a resistor, as shown in Figure 10.

Use the following equation to determine the ideal reset delay time using currents less than 500 μ A:

$$t_{delay} = \frac{2500}{I_{RSTB}} \quad (eq. 1)$$

where: t_{delay} is the ideal reset delay time [ms]
 I_{RSTB} is the current into the RSTB pin [μ A]

Using $I_{RSTB} = 1$ mA removes the delay and allows the reset to act as a “power good” pin.

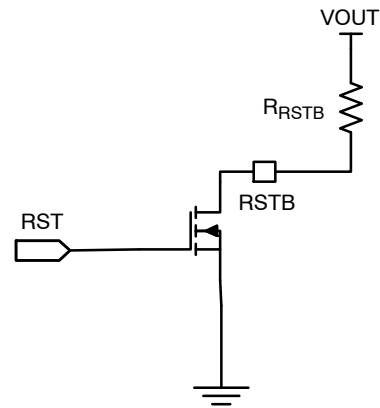

Figure 10. Reset with Adjustable Delay on a Single Pin

The RSTB resistor is commonly tied to VOUT. A RSTB resistor value that sets the current at the reset pin between 0.5 mA and 1 mA is not recommended due to the variation of the threshold between a set delay time and power good. Depending on the output voltage option, typical delay times can be achieved with the following resistor values:

Table 4. TYPICAL DELAY TIMES – MEASURED

R_{RSTB} (k Ω)	t_{delay} (ms) – 5 V	t_{delay} (ms) – 3.3 V	t_{delay} (ms) – 2.5 V
5	–	–	5
10	5	7.6	10
20	10	15	20
30	15	23	–
50	25	–	–

Enable

The NCV890430 is designed to accept either a logic-level signal or battery voltage as an Enable signal. However, if voltages above 40 V are expected, EN should be tied to VIN through a 10 k Ω resistor in order to limit the current flowing into the overvoltage protection of the pin.

A low signal on Enable induces a shutdown mode which shuts off the regulator and minimizes its supply current to less than 5 μ A by disabling all functions.

Once the switching regulator output is enabled, a soft-start is always initiated.

Thermal Shutdown

A thermal shutdown circuit inhibits switching and resets the soft-start circuit if internal temperature exceeds a safe level indicated by the Thermal Shutdown Activation Temperature. Switching is automatically restored when temperature returns to a safe level based on the Thermal Shutdown Hysteresis.

Synchronization

Any number of NCV890430 can be synchronized to an external clock. If a part does not have its switching frequency controlled by the SYNC input, the part will be driven at the 2 MHz default switching frequency. A rising edge at the SYNC pin causes an NCV890430 to immediately turn on the power switch. If another rising edge does not arrive at the SYNC pin, the NCV890430 will start controlling its own frequency within the Master Reassertion Time. This allows uninterrupted operation if the clock is turned off. An external pulldown resistor is not needed at the SYNC pin if it is unconnected.

Exposed Pad

The exposed pad (EPAD) on the back of the package must be electrically connected to both the analog and the power electrical ground GND and PGND pins for proper, noise-free operation. It is recommended to connect these 2 pins directly to the EPAD with a PCB trace. Refer to the Recommended Layout for more information.

NCV890430

DEVICE ORDERING INFORMATION

Device	Output	Marking	Package	Shipping†
NCV890430MW50TXG	5.0 V	V890430-50	DFN8 (Pb-Free)	3000 / Tape & Reel
NCV890430MW33TXG	3.3 V	V890430-33		
NCV890430MW25TXG	2.5 V	V890430-25		

†For information on tape and reel specifications, including part orientation and tape sizes, please refer to our Tape and Reel Packaging Specifications Brochure, BRD8011/D.

RECOMMENDED LAYOUT

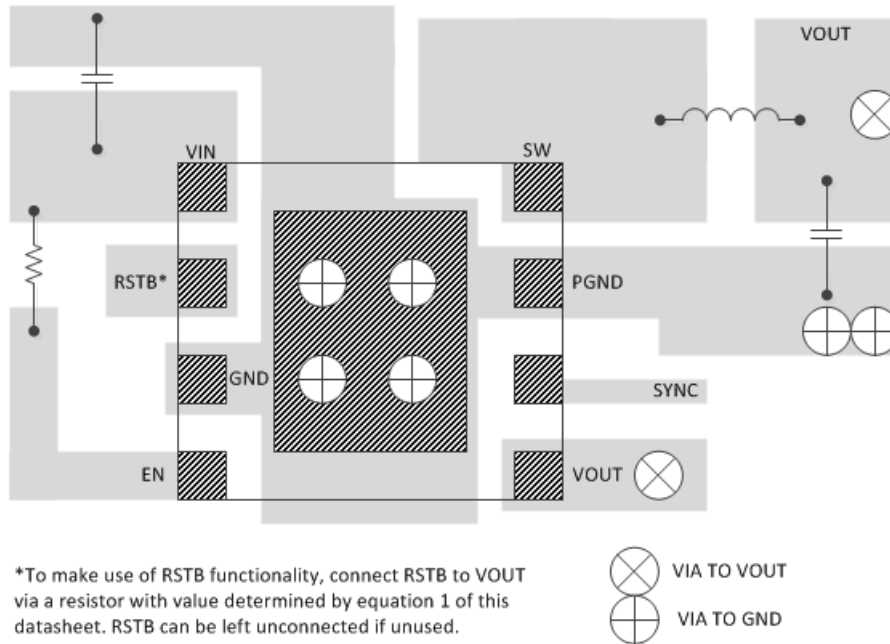

Figure 11. Recommended NCV890430 Layout

MECHANICAL CASE OUTLINE

PACKAGE DIMENSIONS

ON Semiconductor®



SCALE 2:1

DFN8, 3x3, 0.65P
CASE 506BY
ISSUE A

DATE 23 MAY 2012

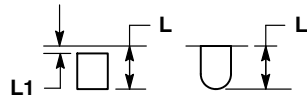
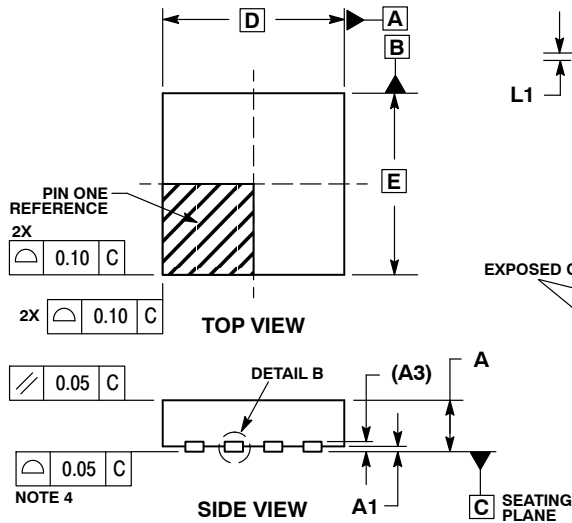

DETAIL A
ALTERNATE
CONSTRUCTIONS

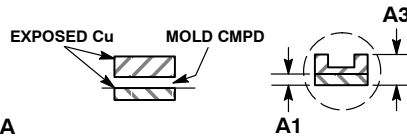

DETAIL B
ALTERNATE
CONSTRUCTIONS

- NOTES:
1. DIMENSIONING AND TOLERANCING PER ASME Y14.5M, 1994.
 2. CONTROLLING DIMENSION: MILLIMETERS.
 3. DIMENSION b APPLIES TO PLATED TERMINAL AND IS MEASURED BETWEEN 0.15 AND 0.30mm FROM THE TERMINAL TIP.
 4. COPLANARITY APPLIES TO THE EXPOSED PAD AS WELL AS THE TERMINALS.
 5. FOR DEVICE OPN CONTAINING W OPTION, DETAIL B ALTERNATE CONSTRUCTION IS NOT APPLICABLE.

DIM	MILLIMETERS	
	MIN	MAX
A	0.80	1.00
A1	0.00	0.05
A3	0.20	REF
b	0.25	0.35
D	3.00	BSC
D2	2.20	2.40
E	3.00	BSC
E2	1.40	1.60
e	0.65	BSC
K	0.20	---
L	0.20	0.40
L1	0.00	0.15

GENERIC MARKING DIAGRAM*

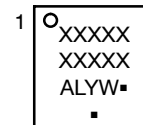

- XXXXX = Specific Device Code
- A = Assembly Location
- L = Wafer Lot
- Y = Year
- W = Work Week
- = Pb-Free Package

(Note: Microdot may be in either location)
*This information is generic. Please refer to device data sheet for actual part marking.
Pb-Free indicator, "G" or microdot "▪", may or may not be present.

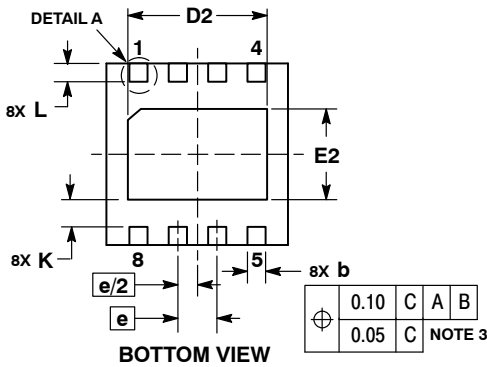

RECOMMENDED SOLDERING FOOTPRINT*

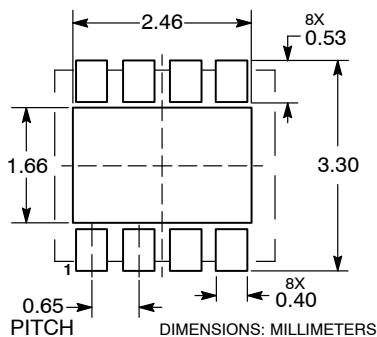

*For additional information on our Pb-Free strategy and soldering details, please download the ON Semiconductor Soldering and Mounting Techniques Reference Manual, SOLDERRM/D.

DOCUMENT NUMBER:	98AON56369E	Electronic versions are uncontrolled except when accessed directly from the Document Repository. Printed versions are uncontrolled except when stamped "CONTROLLED COPY" in red.
DESCRIPTION:	DFN8, 3X3, 0.65P	PAGE 1 OF 1

ON Semiconductor and ON are trademarks of Semiconductor Components Industries, LLC dba ON Semiconductor or its subsidiaries in the United States and/or other countries. ON Semiconductor reserves the right to make changes without further notice to any products herein. ON Semiconductor makes no warranty, representation or guarantee regarding the suitability of its products for any particular purpose, nor does ON Semiconductor assume any liability arising out of the application or use of any product or circuit, and specifically disclaims any and all liability, including without limitation special, consequential or incidental damages. ON Semiconductor does not convey any license under its patent rights nor the rights of others.

onsemi, **Onsemi**, and other names, marks, and brands are registered and/or common law trademarks of Semiconductor Components Industries, LLC dba "**onsemi**" or its affiliates and/or subsidiaries in the United States and/or other countries. **onsemi** owns the rights to a number of patents, trademarks, copyrights, trade secrets, and other intellectual property. A listing of **onsemi**'s product/patent coverage may be accessed at www.onsemi.com/site/pdf/Patent-Marking.pdf. **onsemi** reserves the right to make changes at any time to any products or information herein, without notice. The information herein is provided "as-is" and **onsemi** makes no warranty, representation or guarantee regarding the accuracy of the information, product features, availability, functionality, or suitability of its products for any particular purpose, nor does **onsemi** assume any liability arising out of the application or use of any product or circuit, and specifically disclaims any and all liability, including without limitation special, consequential or incidental damages. Buyer is responsible for its products and applications using **onsemi** products, including compliance with all laws, regulations and safety requirements or standards, regardless of any support or applications information provided by **onsemi**. "Typical" parameters which may be provided in **onsemi** data sheets and/or specifications can and do vary in different applications and actual performance may vary over time. All operating parameters, including "Typicals" must be validated for each customer application by customer's technical experts. **onsemi** does not convey any license under any of its intellectual property rights nor the rights of others. **onsemi** products are not designed, intended, or authorized for use as a critical component in life support systems or any FDA Class 3 medical devices or medical devices with a same or similar classification in a foreign jurisdiction or any devices intended for implantation in the human body. Should Buyer purchase or use **onsemi** products for any such unintended or unauthorized application, Buyer shall indemnify and hold **onsemi** and its officers, employees, subsidiaries, affiliates, and distributors harmless against all claims, costs, damages, and expenses, and reasonable attorney fees arising out of, directly or indirectly, any claim of personal injury or death associated with such unintended or unauthorized use, even if such claim alleges that **onsemi** was negligent regarding the design or manufacture of the part. **onsemi** is an Equal Opportunity/Affirmative Action Employer. This literature is subject to all applicable copyright laws and is not for resale in any manner.

PUBLICATION ORDERING INFORMATION

LITERATURE FULFILLMENT:

Email Requests to: orderlit@onsemi.com

onsemi Website: www.onsemi.com

TECHNICAL SUPPORT

North American Technical Support:

Voice Mail: 1 800-282-9855 Toll Free USA/Canada

Phone: 011 421 33 790 2910

Europe, Middle East and Africa Technical Support:

Phone: 00421 33 790 2910

For additional information, please contact your local Sales Representative

