

# NCV8774

## Ultra Low $I_q$ 350 mA LDO Regulator

The NCV8774 is a 350 mA LDO regulator. Its robustness allows NCV8774 to be used in severe automotive environments. Ultra low quiescent current as low as 18  $\mu\text{A}$  typical makes it suitable for applications permanently connected to battery requiring ultra low quiescent current with or without load. This feature is especially critical when modules remain in active mode when ignition is off. The NCV8774 contains protection functions as current limit, thermal shutdown and reverse output current protection.

### Features

- Output Voltage Options: 3.3 V and 5 V
- Output Voltage Accuracy:  $\pm 1.5\%$  ( $T_J = 25^\circ\text{C}$  to  $125^\circ\text{C}$ )
- Output Current up to 350 mA
- Ultra Low Quiescent Current: typ 18  $\mu\text{A}$  (max 23  $\mu\text{A}$ )
- Very Wide Range of  $C_{out}$  and ESR Values for Stability
- Wide Input Voltage Operation Range: up to 40 V
- Protection Features
  - Current Limitation
  - Thermal Shutdown
- These are Pb-Free Devices

### Typical Applications

- Body Control Module
- Instruments and Clusters
- Occupant Protection and Comfort
- Powertrain

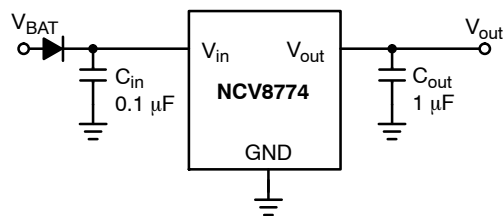

Figure 1. Typical Application Schematic



**ON Semiconductor®**

<http://onsemi.com>

### MARKING DIAGRAM

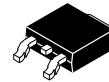

**DPAK-3  
DT SUFFIX  
CASE 369C**

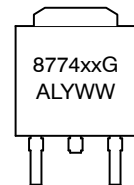

xx = Voltage Option  
A = Assembly Location  
WL, L = Wafer Lot  
Y = Year  
WW = Work Week  
G = Pb-Free Package

### ORDERING INFORMATION

See detailed ordering and shipping information in the package dimensions section on page 11 of this data sheet.

# NCV8774

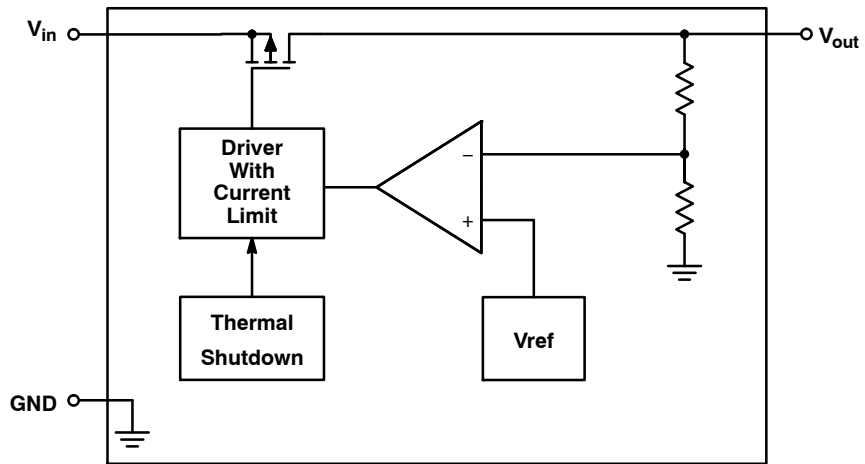

Figure 2. Simplified Block Diagram

## PIN CONNECTIONS

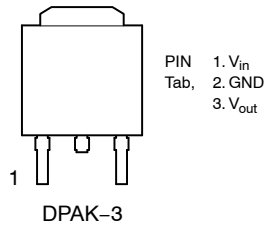

Figure 3. Pin Connections

## PIN FUNCTION DESCRIPTION

Pin No.	Pin Name	Description
1	$V_{in}$	Positive Power Supply Input. Connect 0.1 $\mu\text{F}$ capacitor to ground.
2, TAB	GND	Power Supply Ground.
3	$V_{out}$	Regulated Output Voltage. Connect 1 $\mu\text{F}$ capacitor with ESR < 100 $\Omega$ to ground.

**ABSOLUTE MAXIMUM RATINGS**

Rating	Symbol	Min	Max	Unit
Input Voltage (Note 1) DC Transient, t < 100 ms	V <sub>in</sub>	-0.3 -	40 45	V
Input Current	I <sub>in</sub>	-5	-	mA
Output Voltage (Note 2)	V <sub>out</sub>	-0.3	5.5	V
Output Current	I <sub>out</sub>	-3	Current Limited	mA
Junction Temperature	T <sub>J</sub>	-40	150	°C
Storage Temperature	T <sub>STG</sub>	-55	150	°C

Stresses exceeding Maximum Ratings may damage the device. Maximum Ratings are stress ratings only. Functional operation above the Recommended Operating Conditions is not implied. Extended exposure to stresses above the Recommended Operating Conditions may affect device reliability.

1. Refer to ELECTRICAL CHARACTERISTICS and APPLICATION INFORMATION for Safe Operating Area.
2. 5.5 V or (V<sub>in</sub> + 0.3 V) (whichever is lower).

**ESD CAPABILITY** (Note 3)

Rating	Symbol	Min	Max	Unit
ESD Capability, Human Body Model	ESD <sub>HBM</sub>	-2	2	kV
ESD Capability, Machine Model	ESD <sub>MM</sub>	-200	200	V
ESD Capability, Charged Device Model	ESD <sub>CDM</sub>	-1	1	kV

3. This device series incorporates ESD protection and is tested by the following methods:  
 ESD Human Body Model tested per AEC-Q100-002 (JS-001-2010)  
 ESD Machine Model tested per AEC-Q100-003 (EIA/JESD22-A115)  
 ESD Charge Device Model tested per AEC-Q100-011 (EIA/JESD22-C101)

**LEAD SOLDERING TEMPERATURE AND MSL** (Note 4)

Rating	Symbol	Min	Max	Unit
Moisture Sensitivity Level DPAK-3	MSL		1	-
Lead Temperature Soldering Reflow (SMD Styles Only), Pb-Free Versions	T <sub>SLD</sub>	-	265 peak	°C

4. For more information, please refer to our Soldering and Mounting Techniques Reference Manual, SOLDERRM/D.

**THERMAL CHARACTERISTICS** (Note 5)

Rating	Symbol	Value	Unit
Thermal Characteristics, DPAK-3 Thermal Resistance, Junction-to-Air (Note 6) Thermal Reference, Junction-to-Case (Note 6)	R <sub>θJA</sub> R <sub>ψJC</sub>	56 8.4	°C/W

5. Refer to ELECTRICAL CHARACTERISTICS and APPLICATION INFORMATION for Safe Operating Area.
6. Values based on copper area of 645 mm<sup>2</sup> (or 1 in<sup>2</sup>) of 1 oz copper thickness and FR4 PCB substrate.

**RECOMMENDED OPERATING RANGE** (Note 7)

Rating	Symbol	Min	Max	Unit
Input Voltage (Note 8)	V <sub>in</sub>	4.5	40	V
Junction Temperature	T <sub>J</sub>	-40	150	°C

7. Refer to ELECTRICAL CHARACTERISTICS and APPLICATION INFORMATION for Safe Operating Area.
8. Minimum V<sub>in</sub> = 4.5 V or (V<sub>out</sub> + V<sub>DO</sub>), whichever is higher.

# NCV8774

**ELECTRICAL CHARACTERISTICS**  $V_{in} = 13.2\text{ V}$ ,  $C_{in} = 0.1\ \mu\text{F}$ ,  $C_{out} = 1\ \mu\text{F}$ , for typical values  $T_J = 25^\circ\text{C}$ , for min/max values  $T_J = -40^\circ\text{C}$  to  $150^\circ\text{C}$ ; unless otherwise noted. (Notes 9 and 10)

Parameter	Test Conditions	Symbol	Min	Typ	Max	Unit
<b>REGULATOR OUTPUT</b>						
Output Voltage (Accuracy %)	$T_J = 25^\circ\text{C}$ to $125^\circ\text{C}$ $V_{in} = 4.5\text{ V}$ to $16\text{ V}$ , $I_{out} = 0.1\text{ mA}$ to $200\text{ mA}$ $V_{in} = 5.575\text{ V}$ to $16\text{ V}$ , $I_{out} = 0.1\text{ mA}$ to $200\text{ mA}$	$V_{out}$	3.2505 4.925 (-1.5%)	3.3 5.0	3.3495 5.075 (+1.5%)	V
Output Voltage (Accuracy %)	$V_{in} = 4.5\text{ V}$ to $40\text{ V}$ , $I_{out} = 0.1\text{ mA}$ to $200\text{ mA}$ $V_{in} = 4.5\text{ V}$ to $16\text{ V}$ , $I_{out} = 0.1\text{ mA}$ to $350\text{ mA}$ $V_{in} = 5.6\text{ V}$ to $40\text{ V}$ , $I_{out} = 0.1\text{ mA}$ to $200\text{ mA}$ $V_{in} = 5.975\text{ V}$ to $16\text{ V}$ , $I_{out} = 0.1\text{ mA}$ to $350\text{ mA}$	$V_{out}$	3.234 3.234 4.9 4.9 (-2%)	3.3 3.3 5.0 5.0	3.366 3.366 5.1 5.1 (+2%)	V
Output Voltage (Accuracy %)	$T_J = -40^\circ\text{C}$ to $125^\circ\text{C}$ $V_{in} = 4.5\text{ V}$ to $28\text{ V}$ , $I_{out} = 0\text{ mA}$ to $350\text{ mA}$ $V_{in} = 5.975\text{ V}$ to $28\text{ V}$ , $I_{out} = 0\text{ mA}$ to $350\text{ mA}$	$V_{out}$	3.234 4.9 (-2%)	3.3 5.0	3.366 5.1 (+2%)	V
Line Regulation	$V_{in} = 4.5\text{ V}$ to $28\text{ V}$ , $I_{out} = 5\text{ mA}$ $V_{in} = 6\text{ V}$ to $28\text{ V}$ , $I_{out} = 5\text{ mA}$	$Reg_{line}$	-20	0	20	mV
Load Regulation	$I_{out} = 0.1\text{ mA}$ to $350\text{ mA}$	$Reg_{load}$	-35	0	35	mV
Dropout Voltage (Note 11)	$I_{out} = 200\text{ mA}$ $I_{out} = 350\text{ mA}$	$V_{DO}$	- -	250 440	500 875	mV

## QUIESCENT CURRENT

Quiescent Current ( $I_q = I_{in} - I_{out}$ )	$I_{out} = 0.1\text{ mA}$ , $T_J = 25^\circ\text{C}$ $I_{out} = 0.1\text{ mA}$ to $350\text{ mA}$ , $T_J \leq 125^\circ\text{C}$	$I_q$	- -	18 -	22 23	$\mu\text{A}$
--	---	-------	--------	---------	----------	---------------

## CURRENT LIMIT PROTECTION

Current Limit	$V_{out} = 0.96 \times V_{out\_nom}$	$I_{LIM}$	400	-	1100	mA
Short Circuit Current Limit	$V_{out} = 0\text{ V}$	$I_{SC}$	400	-	1100	mA

## PSRR

Power Supply Ripple Rejection (Note 12)	$f = 100\text{ Hz}$ , $0.5\text{ V}_{pp}$	PSRR	-	54	-	dB
---	---	------	---	----	---	----

## THERMAL SHUTDOWN

Thermal Shutdown Temperature (Note 12)		$T_{SD}$	150	175	195	$^\circ\text{C}$
Thermal Shutdown Hysteresis (Note 12)		$T_{SH}$	-	25	-	$^\circ\text{C}$

9. Refer to ABSOLUTE MAXIMUM RATINGS and APPLICATION INFORMATION for Safe Operating Area.

10. Performance guaranteed over the indicated operating temperature range by design and/or characterization tested at  $T_A \approx T_J$ . Low duty cycle pulse techniques are used during testing to maintain the junction temperature as close to ambient as possible.

11. Measured when output voltage falls 100 mV below the regulated voltage at  $V_{in} = 13.2\text{ V}$ .

12. Values based on design and/or characterization.

TYPICAL CHARACTERISTICS

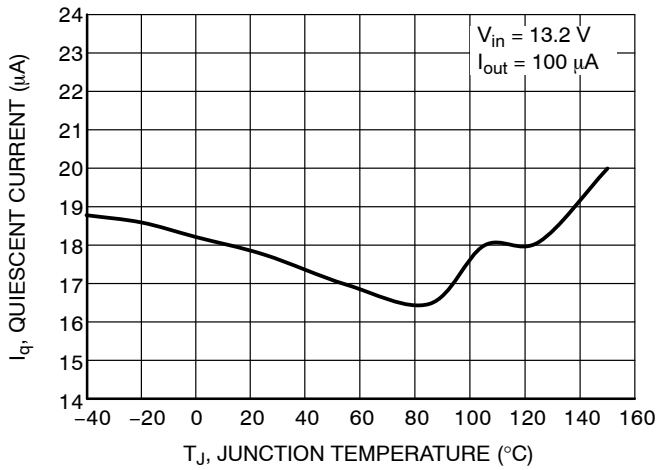

Figure 4. Quiescent Current vs. Temperature

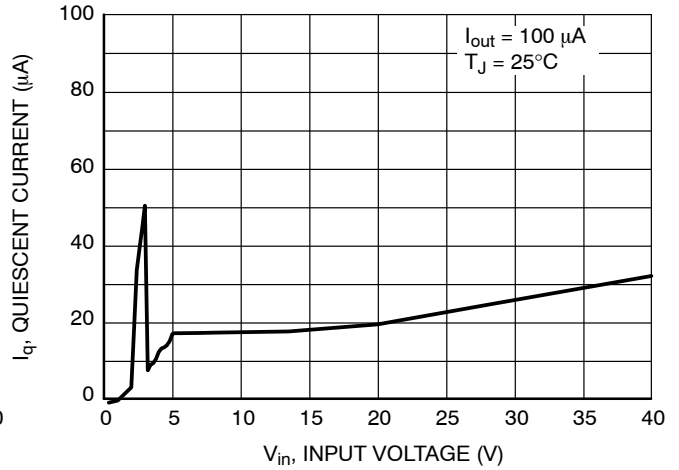

Figure 5. Quiescent Current vs. Input Voltage

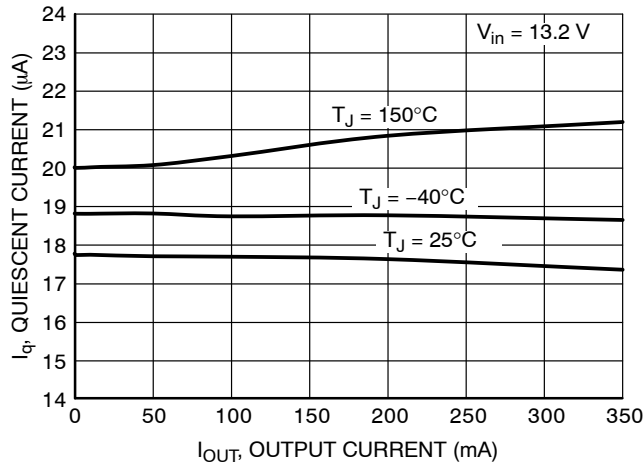

Figure 6. Quiescent Current vs. Output Current

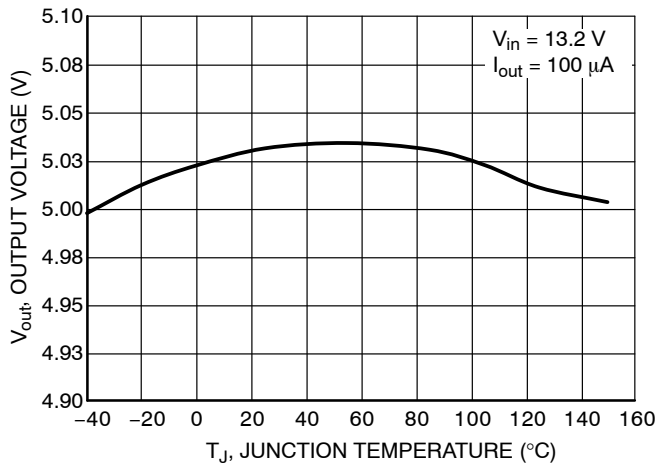

Figure 7. Output Voltage vs. Temperature (5 V Option)

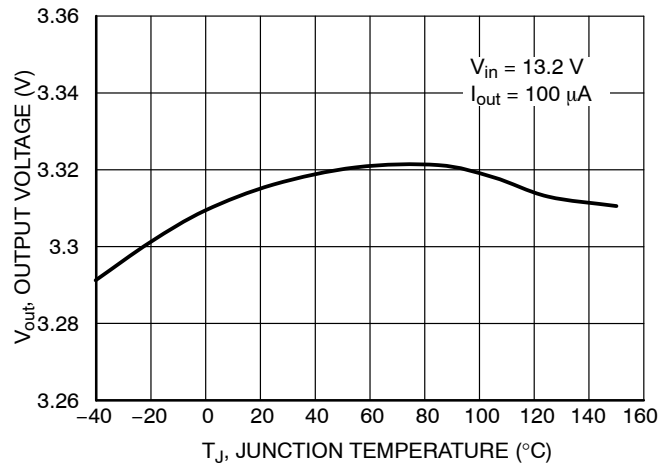

Figure 8. Output Voltage vs. Temperature (3.3 V Option)

TYPICAL CHARACTERISTICS

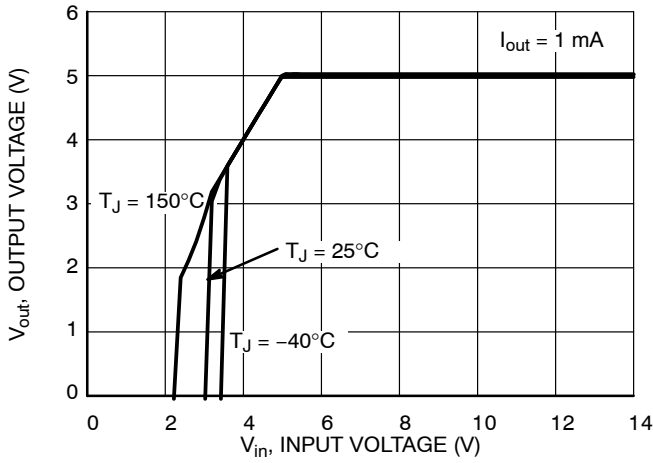

Figure 9. Output Voltage vs. Input Voltage (5 V Option)

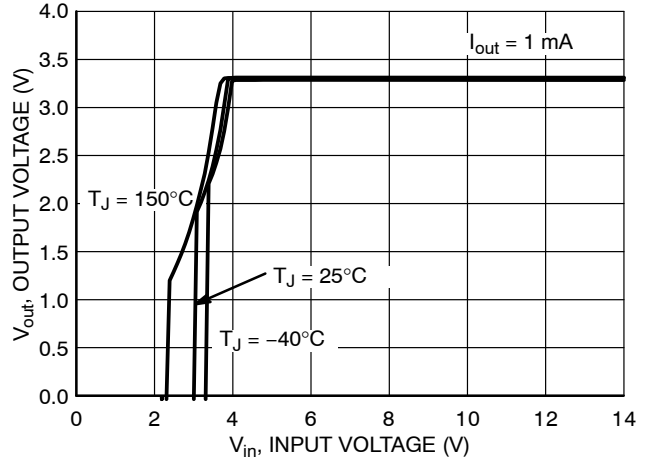

Figure 10. Output Voltage vs. Input Voltage (3.3 V Option)

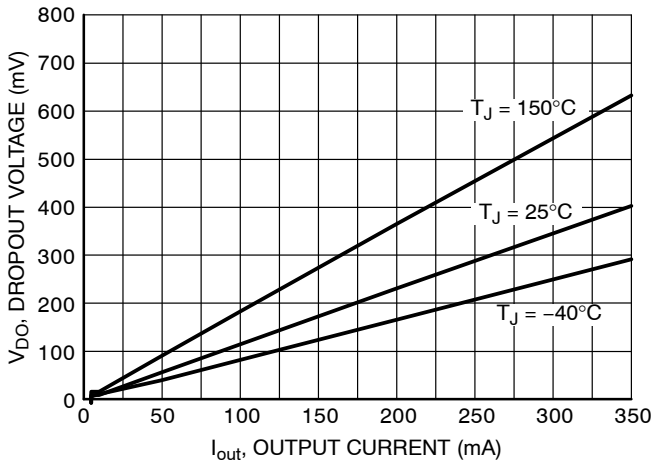

Figure 11. Dropout vs. Output Current (5 V Option)

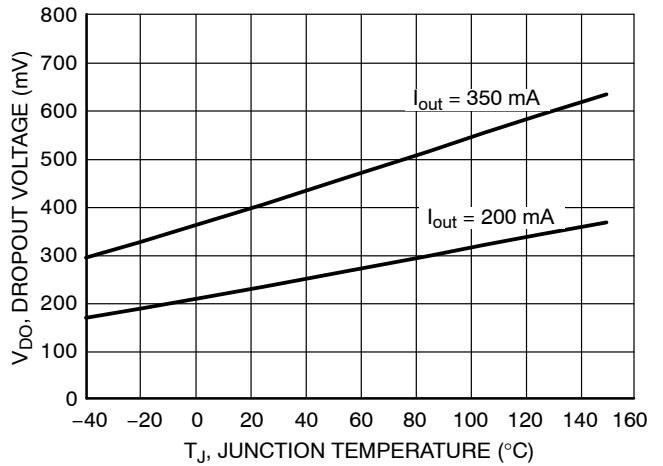

Figure 12. Dropout vs. Temperature (5 V Option)

TYPICAL CHARACTERISTICS

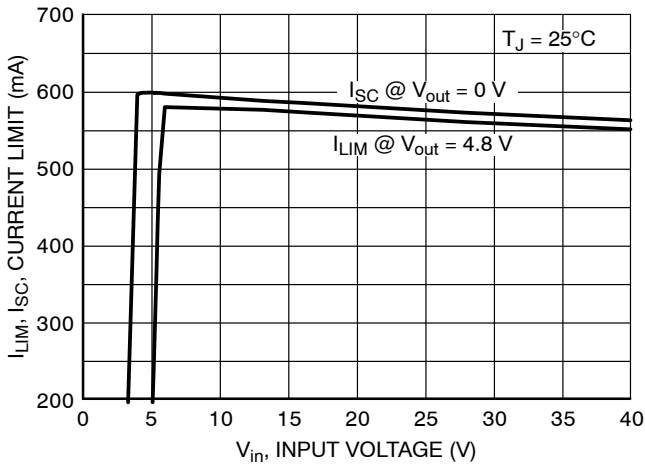

Figure 13. Output Current Limit vs. Input Voltage (5 V Option)

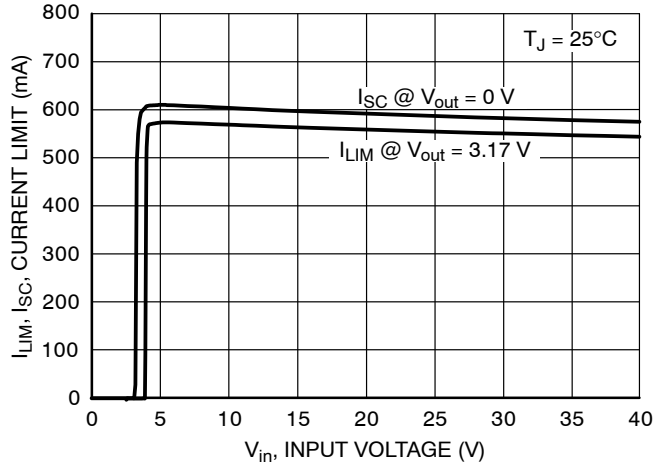

Figure 14. Output Current Limit vs. Input Voltage (3.3 V Option)

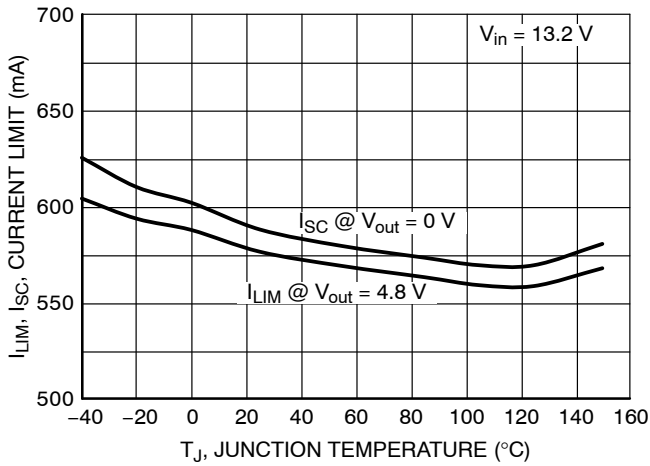

Figure 15. Output Current Limit vs. Temperature (5 V Option)

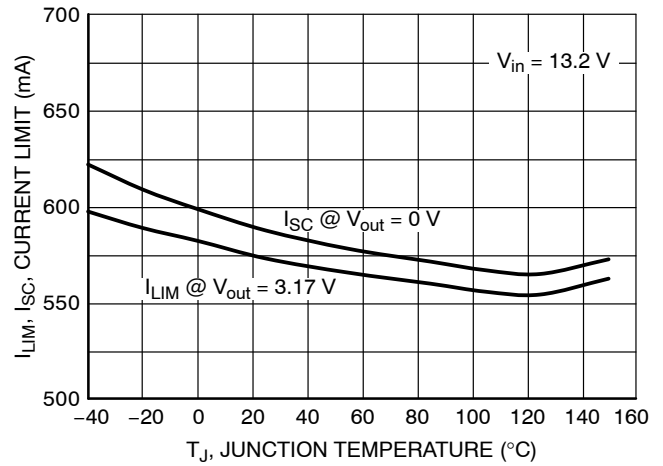

Figure 16. Output Current Limit vs. Temperature (3.3 V Option)

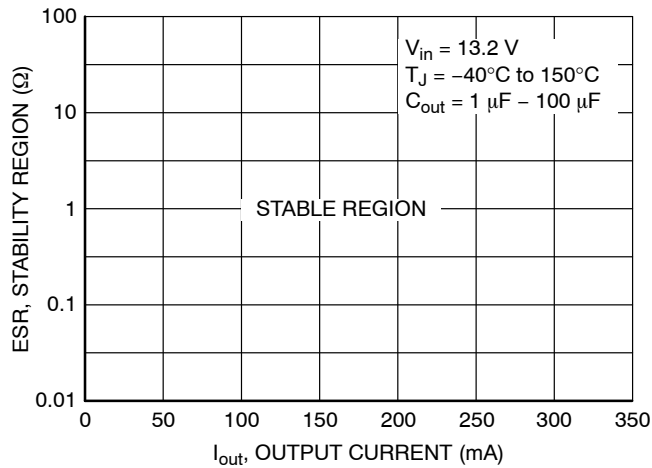
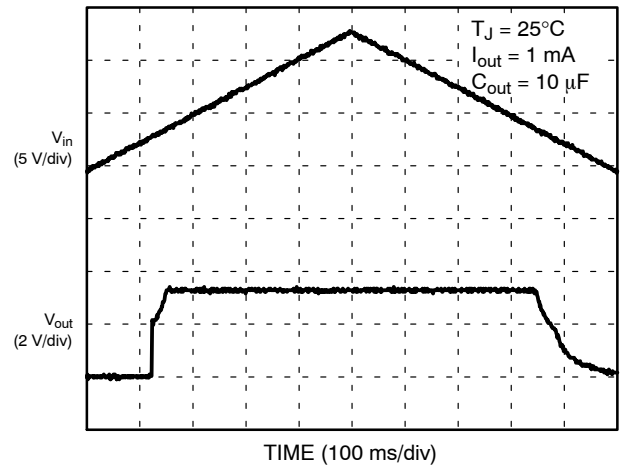
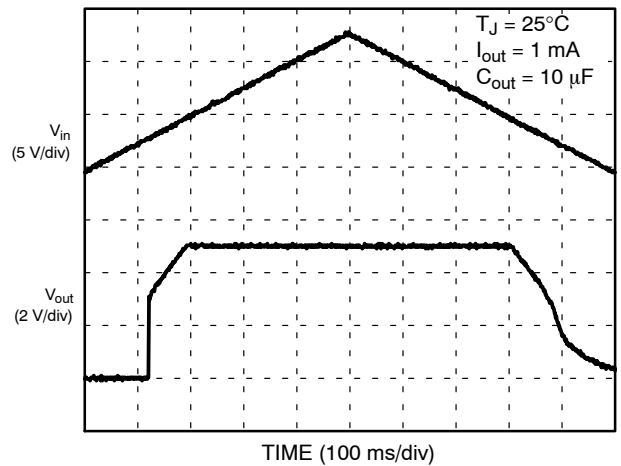
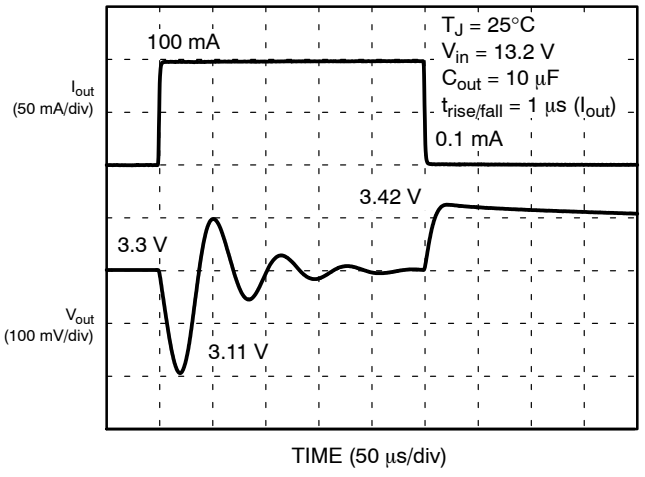
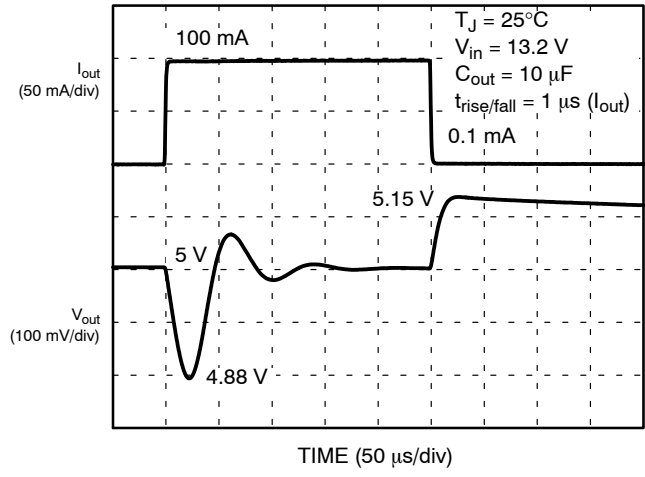
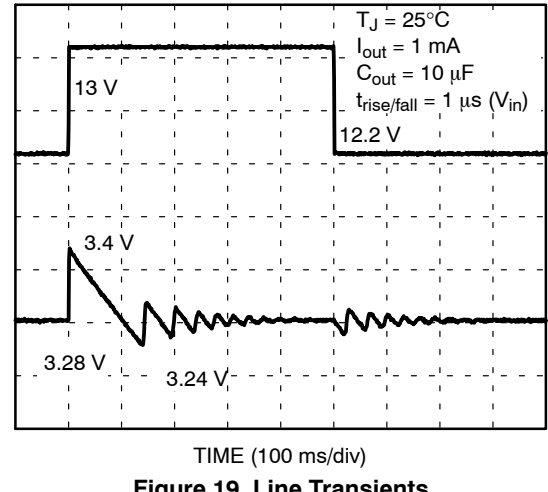
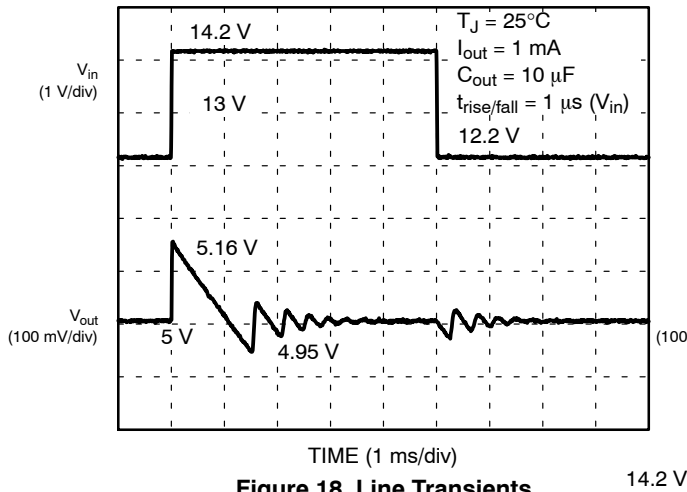

Figure 17.  $C_{out}$  ESR Stability Region vs. Output Current

TYPICAL CHARACTERISTICS





TYPICAL CHARACTERISTICS

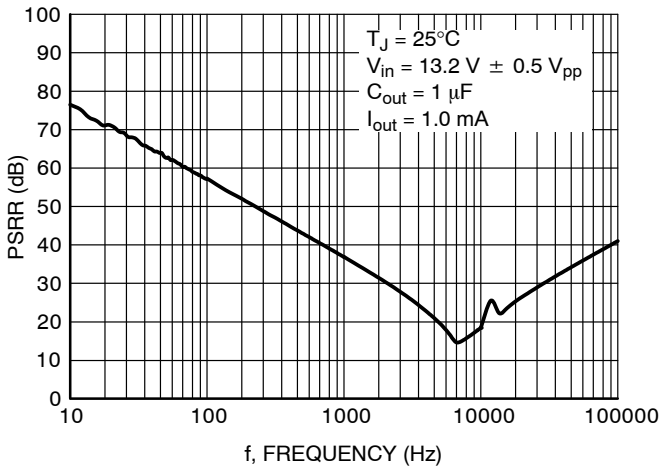

Figure 24. PSRR vs. Frequency (5 V Option)

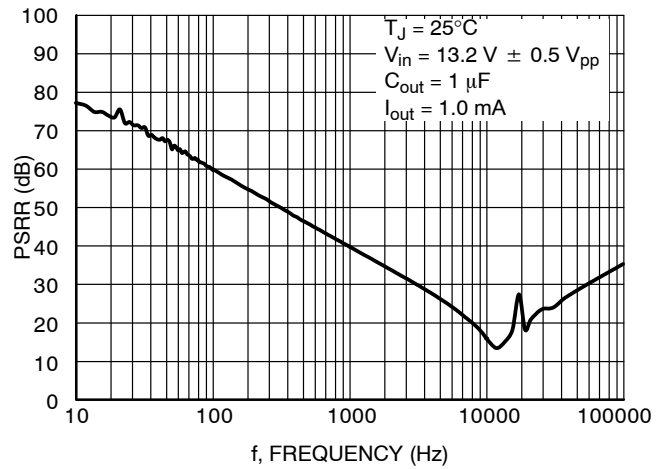

Figure 25. PSRR vs. Frequency (3.3 V Option)

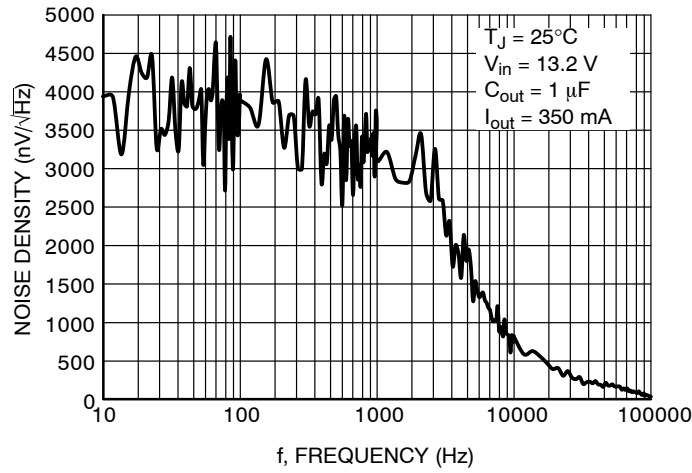

Figure 26. Noise vs. Frequency

## DEFINITIONS

### General

All measurements are performed using short pulse low duty cycle techniques to maintain junction temperature as close as possible to ambient temperature.

### Output voltage

The output voltage parameter is defined for specific temperature, input voltage and output current values or specified over Line, Load and Temperature ranges.

### Line Regulation

The change in output voltage for a change in input voltage measured for specific output current over operating ambient temperature range.

### Load Regulation

The change in output voltage for a change in output current measured for specific input voltage over operating ambient temperature range.

### Dropout Voltage

The input to output differential at which the regulator output no longer maintains regulation against further reductions in input voltage. It is measured when the output drops 100 mV below its nominal value. The junction temperature, load current, and minimum input supply requirements affect the dropout level.

### Quiescent and Disable Currents

Quiescent Current ( $I_q$ ) is the difference between the input current (measured through the LDO input pin) and the output load current.

### Current Limit and Short Circuit Current Limit

Current Limit is value of output current by which output voltage drops below 96% of its nominal value. Short Circuit Current Limit is output current value measured with output of the regulator shorted to ground.

### PSRR

Power Supply Rejection Ratio is defined as ratio of output voltage and input voltage ripple. It is measured in decibels (dB).

### Line Transient Response

Typical output voltage overshoot and undershoot response when the input voltage is excited with a given slope.

### Load Transient Response

Typical output voltage overshoot and undershoot response when the output current is excited with a given slope between low-load and high-load conditions.

### Thermal Protection

Internal thermal shutdown circuitry is provided to protect the integrated circuit in the event that the maximum junction temperature is exceeded. When activated at typically 175°C, the regulator turns off. This feature is provided to prevent failures from accidental overheating.

### Maximum Package Power Dissipation

The power dissipation level is maximum allowed power dissipation for particular package or power dissipation at which the junction temperature reaches its maximum operating value, whichever is lower.

APPLICATIONS INFORMATION

The NCV8774 regulator is self-protected with internal thermal shutdown and internal current limit. Typical characteristics are shown in Figures 4 to 26.

**Input Decoupling (C<sub>in</sub>)**

A ceramic or tantalum 0.1 μF capacitor is recommended and should be connected close to the NCV8774 package. Higher capacitance and lower ESR will improve the overall line and load transient response.

If extremely fast input voltage transients are expected then appropriate input filter must be used in order to decrease rising and/or falling edges below 50 V/μs for proper operation. The filter can be composed of several capacitors in parallel.

**Output Decoupling (C<sub>out</sub>)**

The NCV8774 is a stable component and does not require a minimum Equivalent Series Resistance (ESR) for the output capacitor. Stability region of ESR vs Output Current is shown in Figure 17. The minimum output decoupling value is 1 μF and can be augmented to fulfill stringent load transient requirements. The regulator works with ceramic chip capacitors as well as tantalum devices. Larger values improve noise rejection and load regulation transient response.

**Thermal Considerations**

As power in the NCV8774 increases, it might become necessary to provide some thermal relief. The maximum power dissipation supported by the device is dependent upon board design and layout. Mounting pad configuration on the PCB, the board material, and the ambient temperature affect the rate of junction temperature rise for the part. When the NCV8774 has good thermal conductivity through the PCB, the junction temperature will be relatively low with high power applications. The maximum dissipation the NCV8774 can handle is given by:

$$P_{D(max)} = \frac{[T_{J(max)} - T_A]}{R_{\theta JA}} \quad (eq. 1)$$

**ORDERING INFORMATION**

Device	Output Voltage	Marking	Package	Shipping†
NCV8774DT50RKG	5.0 V	877450G	DPAK-3 (Pb-Free)	2500 / Tape & Reel
NCV8774DT33RKG	3.3 V	877433G	DPAK-3 (Pb-Free)	2500 / Tape & Reel

†For information on tape and reel specifications, including part orientation and tape sizes, please refer to our Tape and Reel Packaging Specifications Brochure, BRD8011/D.

Since T<sub>J</sub> is not recommended to exceed 150°C, then the NCV8774 soldered on 645 mm<sup>2</sup>, 1 oz copper area, FR4 can dissipate up to 2.35 W when the ambient temperature (T<sub>A</sub>) is 25°C. See Figure 27 for R<sub>θJA</sub> versus PCB area. The power dissipated by the NCV8774 can be calculated from the following equations:

$$P_D = V_{in}(I_q@I_{out}) + I_{out}(V_{in} - V_{out}) \quad (eq. 2)$$

or

$$V_{in(max)} = \frac{P_{D(max)} + (V_{out} \times I_{out})}{I_{out} + I_q} \quad (eq. 3)$$

NOTE: Items containing I<sub>q</sub> can be neglected if I<sub>out</sub> >> I<sub>q</sub>.

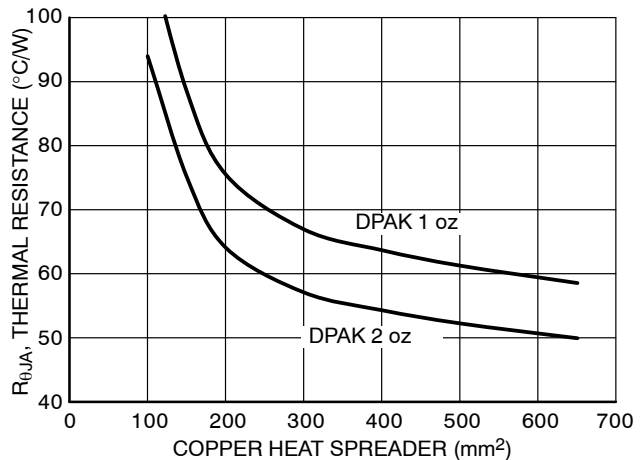

Figure 27. Thermal Resistance vs. PCB Copper Area

**Hints**

V<sub>in</sub> and GND printed circuit board traces should be as wide as possible. When the impedance of these traces is high, there is a chance to pick up noise or cause the regulator to malfunction. Place external components, especially the output capacitor, as close as possible to the NCV8774 and make traces as short as possible.

# MECHANICAL CASE OUTLINE

## PACKAGE DIMENSIONS

ON Semiconductor®

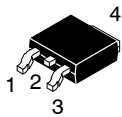

SCALE 1:1

### DPAK (SINGLE GAUGE) CASE 369C ISSUE F

DATE 21 JUL 2015

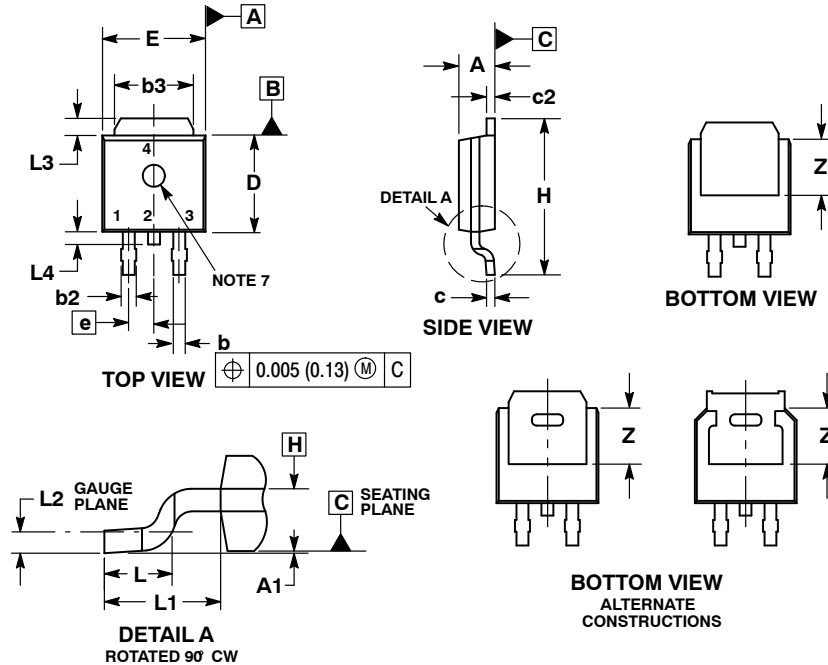

NOTES:

1. DIMENSIONING AND TOLERANCING PER ASME Y14.5M, 1994.
2. CONTROLLING DIMENSION: INCHES.
3. THERMAL PAD CONTOUR OPTIONAL WITHIN DIMENSIONS b3, L3 and Z.
4. DIMENSIONS D AND E DO NOT INCLUDE MOLD FLASH, PROTRUSIONS, OR BURRS. MOLD FLASH, PROTRUSIONS, OR GATE BURRS SHALL NOT EXCEED 0.006 INCHES PER SIDE.
5. DIMENSIONS D AND E ARE DETERMINED AT THE OUTERMOST EXTREMES OF THE PLASTIC BODY.
6. DATUMS A AND B ARE DETERMINED AT DATUM PLANE H.
7. OPTIONAL MOLD FEATURE.

DIM	INCHES		MILLIMETERS	
	MIN	MAX	MIN	MAX
A	0.086	0.094	2.18	2.38
A1	0.000	0.005	0.00	0.13
b	0.025	0.035	0.63	0.89
b2	0.028	0.045	0.72	1.14
b3	0.180	0.215	4.57	5.46
c	0.018	0.024	0.46	0.61
c2	0.018	0.024	0.46	0.61
D	0.235	0.245	5.97	6.22
E	0.250	0.265	6.35	6.73
e	0.090 BSC		2.29 BSC	
H	0.370	0.410	9.40	10.41
L	0.055	0.070	1.40	1.78
L1	0.114 REF		2.90 REF	
L2	0.020 BSC		0.51 BSC	
L3	0.035	0.050	0.89	1.27
L4	---	0.040	---	1.01
Z	0.155	---	3.93	---

### GENERIC MARKING DIAGRAM\*

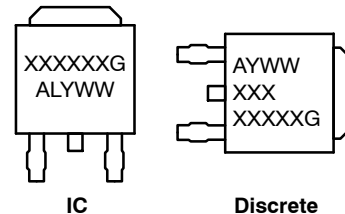

- XXXXXX = Device Code
- A = Assembly Location
- L = Wafer Lot
- Y = Year
- WW = Work Week
- G = Pb-Free Package

\*This information is generic. Please refer to device data sheet for actual part marking.

- |  |  |   |   |  |
|--|--|---|---|--|
| <p>STYLE 1:<br/>PIN 1. BASE<br/>2. COLLECTOR<br/>3. EMITTER<br/>4. COLLECTOR</p> | <p>STYLE 2:<br/>PIN 1. GATE<br/>2. DRAIN<br/>3. SOURCE<br/>4. DRAIN</p>          | <p>STYLE 3:<br/>PIN 1. ANODE<br/>2. CATHODE<br/>3. ANODE<br/>4. CATHODE</p> | <p>STYLE 4:<br/>PIN 1. CATHODE<br/>2. ANODE<br/>3. GATE<br/>4. ANODE</p>              | <p>STYLE 5:<br/>PIN 1. GATE<br/>2. ANODE<br/>3. CATHODE<br/>4. ANODE</p>     |
| <p>STYLE 6:<br/>PIN 1. MT1<br/>2. MT2<br/>3. GATE<br/>4. MT2</p>                 | <p>STYLE 7:<br/>PIN 1. GATE<br/>2. COLLECTOR<br/>3. EMITTER<br/>4. COLLECTOR</p> | <p>STYLE 8:<br/>PIN 1. N/C<br/>2. CATHODE<br/>3. ANODE<br/>4. CATHODE</p>   | <p>STYLE 9:<br/>PIN 1. ANODE<br/>2. CATHODE<br/>3. RESISTOR ADJUST<br/>4. CATHODE</p> | <p>STYLE 10:<br/>PIN 1. CATHODE<br/>2. ANODE<br/>3. CATHODE<br/>4. ANODE</p> |

### SOLDERING FOOTPRINT\*

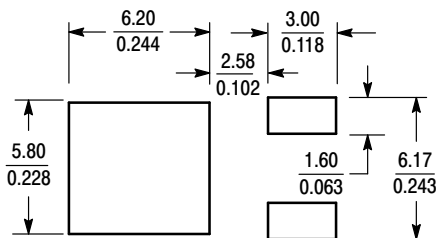

SCALE 3:1 (mm/inches)

\*For additional information on our Pb-Free strategy and soldering details, please download the ON Semiconductor Soldering and Mounting Techniques Reference Manual, SOLDERRM/D.

DOCUMENT NUMBER:	98AON10527D	Electronic versions are uncontrolled except when accessed directly from the Document Repository. Printed versions are uncontrolled except when stamped "CONTROLLED COPY" in red.
DESCRIPTION:	DPAK (SINGLE GAUGE)	PAGE 1 OF 1

ON Semiconductor and ON are trademarks of Semiconductor Components Industries, LLC dba ON Semiconductor or its subsidiaries in the United States and/or other countries. ON Semiconductor reserves the right to make changes without further notice to any products herein. ON Semiconductor makes no warranty, representation or guarantee regarding the suitability of its products for any particular purpose, nor does ON Semiconductor assume any liability arising out of the application or use of any product or circuit, and specifically disclaims any and all liability, including without limitation special, consequential or incidental damages. ON Semiconductor does not convey any license under its patent rights nor the rights of others.

**onsemi**, **Onsemi**, and other names, marks, and brands are registered and/or common law trademarks of Semiconductor Components Industries, LLC dba "**onsemi**" or its affiliates and/or subsidiaries in the United States and/or other countries. **onsemi** owns the rights to a number of patents, trademarks, copyrights, trade secrets, and other intellectual property. A listing of **onsemi**'s product/patent coverage may be accessed at [www.onsemi.com/site/pdf/Patent-Marking.pdf](http://www.onsemi.com/site/pdf/Patent-Marking.pdf). **onsemi** reserves the right to make changes at any time to any products or information herein, without notice. The information herein is provided "as-is" and **onsemi** makes no warranty, representation or guarantee regarding the accuracy of the information, product features, availability, functionality, or suitability of its products for any particular purpose, nor does **onsemi** assume any liability arising out of the application or use of any product or circuit, and specifically disclaims any and all liability, including without limitation special, consequential or incidental damages. Buyer is responsible for its products and applications using **onsemi** products, including compliance with all laws, regulations and safety requirements or standards, regardless of any support or applications information provided by **onsemi**. "Typical" parameters which may be provided in **onsemi** data sheets and/or specifications can and do vary in different applications and actual performance may vary over time. All operating parameters, including "Typicals" must be validated for each customer application by customer's technical experts. **onsemi** does not convey any license under any of its intellectual property rights nor the rights of others. **onsemi** products are not designed, intended, or authorized for use as a critical component in life support systems or any FDA Class 3 medical devices or medical devices with a same or similar classification in a foreign jurisdiction or any devices intended for implantation in the human body. Should Buyer purchase or use **onsemi** products for any such unintended or unauthorized application, Buyer shall indemnify and hold **onsemi** and its officers, employees, subsidiaries, affiliates, and distributors harmless against all claims, costs, damages, and expenses, and reasonable attorney fees arising out of, directly or indirectly, any claim of personal injury or death associated with such unintended or unauthorized use, even if such claim alleges that **onsemi** was negligent regarding the design or manufacture of the part. **onsemi** is an Equal Opportunity/Affirmative Action Employer. This literature is subject to all applicable copyright laws and is not for resale in any manner.

## PUBLICATION ORDERING INFORMATION

### LITERATURE FULFILLMENT:

Email Requests to: [orderlit@onsemi.com](mailto:orderlit@onsemi.com)

**onsemi Website:** [www.onsemi.com](http://www.onsemi.com)

### TECHNICAL SUPPORT

**North American Technical Support:**

Voice Mail: 1 800-282-9855 Toll Free USA/Canada

Phone: 011 421 33 790 2910

**Europe, Middle East and Africa Technical Support:**

Phone: 00421 33 790 2910

For additional information, please contact your local Sales Representative

