

1.5 A low drop positive voltage regulator adjustable and fixed

Features

- Typical dropout 1.3 V at 1.5 A
- Three terminal adjustable or fixed output voltage 1.5 V, 1.8 V, 2.5 V, 3.3 V, 3.6 V, 5 V, 8 V, 12 V
- Automotive Grade product: adjustable V_{OUT} only in TO-220 and DPAK packages
- Guaranteed output current up to 1.5A
- Output tolerance $\pm 1\%$ at 25 °C and $\pm 2\%$ in full temperature range
- Internal power and thermal limit
- Wide operating temperature range -40 °C to 125 °C
- Package available: TO-220, D²PAK, D²PAK/A, DPAK
- Pinout compatibility with standard adjustable VREG

Description

The LD1086 is a LOW DROP voltage regulator able to provide up to 1.5 A of output current. Dropout is guaranteed at a maximum of 1.2 V at the maximum output current, decreasing at lower loads. The LD1086 is pin to pin compatible with the older 3-terminal adjustable regulators, but has better performances in term of drop and output tolerance.

A 2.85 V output version is suitable for SCSI-2 active termination. Unlike PNP regulators, where a part of the output current is wasted as quiescent current, the LD1086 quiescent current flows into

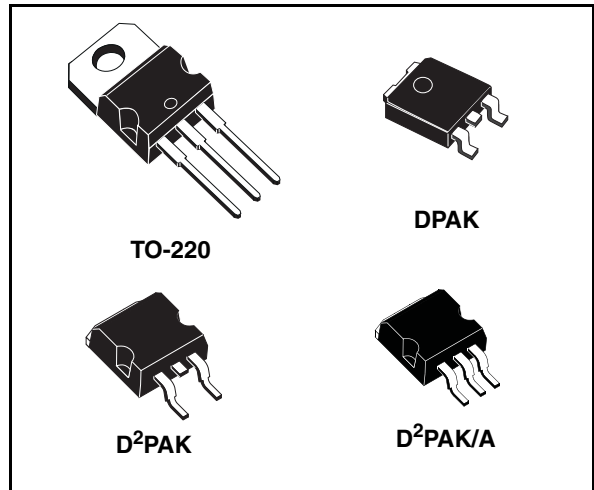

the load, so increase efficiency. Only a 10 μ F minimum capacitor is need for stability. The device is supplied in TO-220, D²PAK, D²PAK/A and DPAK. On chip trimming allows the regulator to reach a very tight output voltage tolerance, within $\pm 1\%$ at 25 °C.

The LD1086 is available as Automotive Grade in TO-220 and DPAK packages, for the option of adjustable output voltage whose commercial Part Numbers are shown in the [Table 18](#) (order codes). These devices are qualified according to the specification AEC-Q100 of the Automotive market, in the temperature range -40 °C to 125 °C, and the statistical tests PAT, SYL, SBL are performed.

Table 1. Device summary

Part number		
LD1086XX	LD1086XX18	LD1086XX36
LD1086XX12	LD1086XX25	LD1086XX50
LD1086XX15	LD1086XX33	LD1086XX80

Contents

1	Diagram	5
2	Pin configuration	6
3	Maximum ratings	7
4	Schematic application	8
5	Electrical characteristics	9
6	Typical application	19
7	Package mechanical data	24
8	Order codes	37
9	Revision history	38

List of figures

Figure 1.	Schematic diagram	5
Figure 2.	Pin connections (top view)	6
Figure 3.	Application circuit	8
Figure 4.	Output voltage vs temperature	19
Figure 5.	Output voltage vs temperature	19
Figure 6.	Output voltage vs temperature	19
Figure 7.	Short circuit current vs dropout voltage	19
Figure 8.	Line regulation vs temperature	19
Figure 9.	Load regulation vs temperature	19
Figure 10.	Dropout voltage vs temperature	20
Figure 11.	Dropout voltage vs output current	20
Figure 12.	Adjust pin current vs input voltage	20
Figure 13.	Adjust pin current vs temperature	20
Figure 14.	Adjust pin current vs output current	20
Figure 15.	Quiescent current vs output current	20
Figure 16.	Quiescent current vs input voltage	21
Figure 17.	Supply voltage rejection vs output current	21
Figure 18.	Supply voltage rejection vs frequency	21
Figure 19.	Supply voltage rejection vs temperature	21
Figure 20.	Minimum load current vs temperature	21
Figure 21.	Stability for adjustable	21
Figure 22.	Stability for 2.85 V	22
Figure 23.	Stability for 12 V	22
Figure 24.	Line transient	22
Figure 25.	Line transient	22
Figure 26.	Line transient	22
Figure 27.	Load transient	22
Figure 28.	Load transient	23
Figure 29.	Thermal protection	23
Figure 30.	Drawing dimension D ² PAK (type STD-ST)	27
Figure 31.	Drawing dimension D ² PAK (type WOOSEOK-SUBCON.)	28
Figure 32.	D2PAK footprint recommended data	30
Figure 33.	Drawing dimension D ² PAK/A (type STD-ST)	31
Figure 34.	Drawing dimension D ² PAK/A (type WOOSEOK-Subcon.)	32
Figure 35.	D ² PAK/A footprint recommended data	34

List of tables

Table 1.	Device summary	1
Table 2.	Absolute maximum ratings	7
Table 3.	Thermal data.	7
Table 4.	Electrical characteristics of LD1086#15	9
Table 5.	Electrical characteristics of LD1086#18	10
Table 6.	Electrical characteristics of LD1086#25	11
Table 7.	Electrical characteristics of LD1086#33	12
Table 8.	Electrical characteristics of LD1086#36	13
Table 9.	Electrical characteristics of LD1086#50	14
Table 10.	Electrical characteristics of LD1086#80	15
Table 11.	Electrical characteristics of LD1086#12	16
Table 12.	Electrical characteristics of LD1086#	17
Table 13.	Electrical characteristics of LD1086DTTRY and LD1086VY (Automotive Grade)	18
Table 14.	D ² PAK mechanical data	29
Table 15.	Footprint data	30
Table 16.	D ² PAK/A mechanical data	33
Table 17.	Footprint data	34
Table 18.	Order codes	37
Table 19.	Document revision history	38

1 Diagram

Figure 1. Schematic diagram

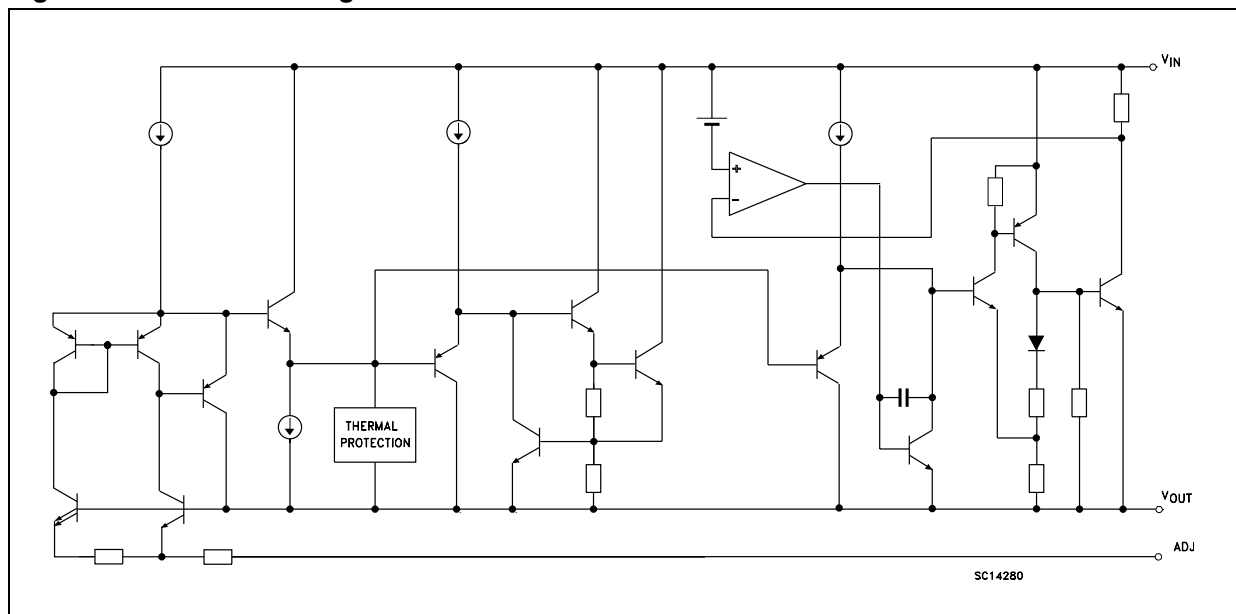

2 Pin configuration

Figure 2. Pin connections (top view)

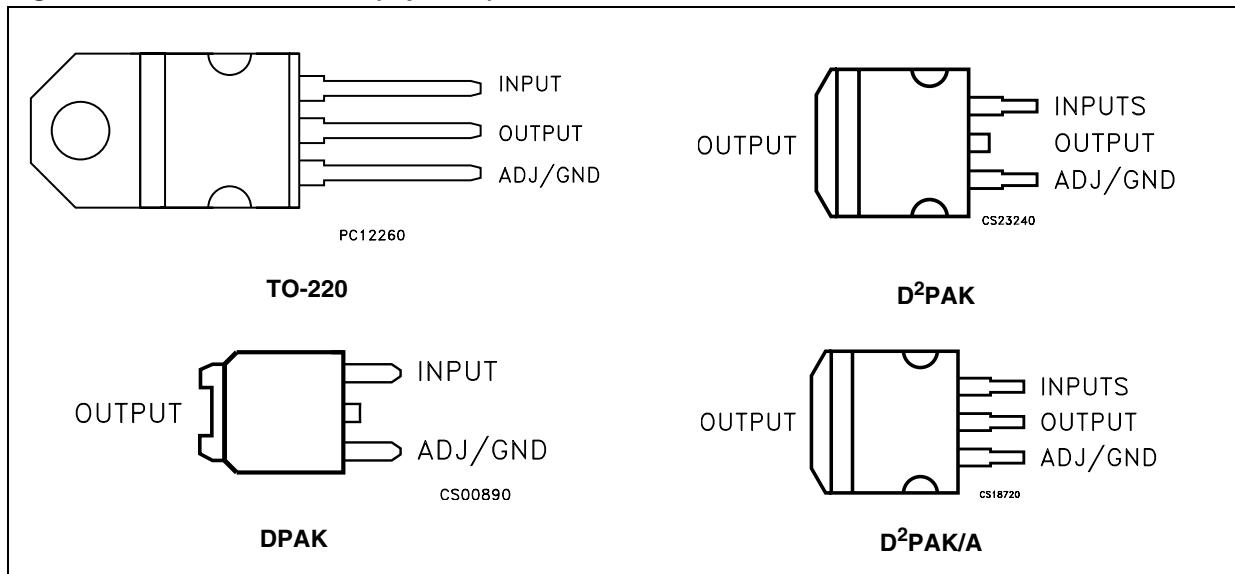

Note: The TAB is physically connected to the output (this is valid for the TO-220 package too).

3 Maximum ratings

Table 2. Absolute maximum ratings

Symbol	Parameter	Value	Unit
V_I	DC input voltage	30	V
I_O	Output current	Internally Limited	mA
P_D	Power dissipation	Internally Limited	mW
T_{STG}	Storage temperature range	-55 to +150	°C
T_{OP}	Operating junction temperature range	-40 to +125	°C

Note: Absolute Maximum Ratings are those values beyond which damage to the device may occur. Functional operation under these condition is not implied

Table 3. Thermal data

Symbol	Parameter	TO-220	D ² PAK D ² PAK/A	DPAK	Unit
R_{thJC}	Thermal resistance junction-case	3	3	8	°C/W
R_{thJA}	Thermal resistance junction-ambient	50	62.5		°C/W

4 Schematic application

Figure 3. Application circuit

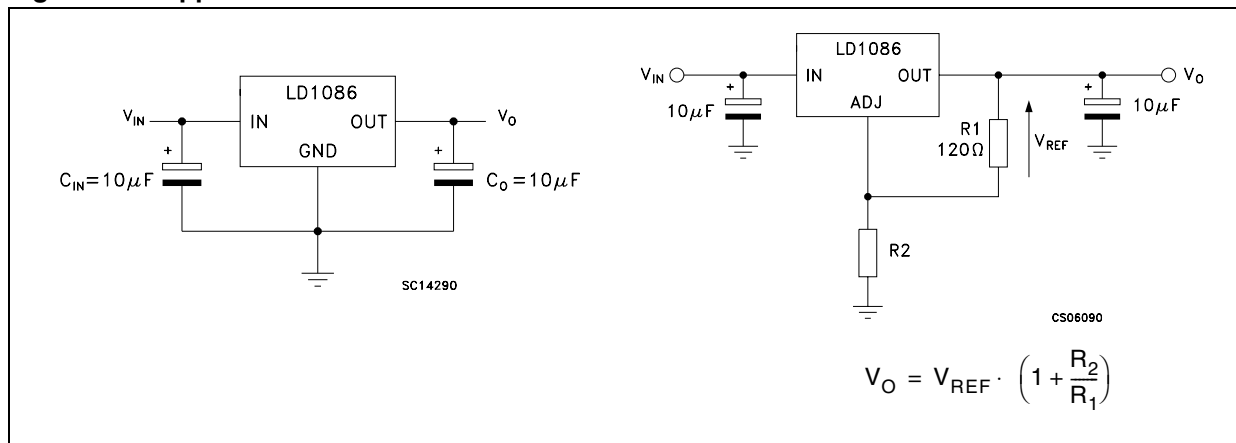

5 Electrical characteristics

Table 4. Electrical characteristics of LD1086#15
($V_I = 4.5\text{ V}$, $C_I = C_O = 10\ \mu\text{F}$, $T_A = -40\text{ to }125\text{ }^\circ\text{C}$, unless otherwise specified).

Symbol	Parameter	Test condition	Min.	Typ.	Max.	Unit
V_O	Output voltage ⁽¹⁾	$I_O = 0\text{ mA}$, $T_J = 25^\circ\text{C}$	1.485	1.5	1.515	V
		$I_O = 0\text{ to }1.5\text{A}$, $V_I = 3.4\text{ to }30\text{V}$	1.47	1.5	1.53	V
ΔV_O	Line regulation	$I_O = 0\text{ mA}$, $V_I = 3.1\text{ to }18\text{V}$, $T_J = 25^\circ\text{C}$		0.2	4	mV
		$I_O = 0\text{ mA}$, $V_I = 3.1\text{ to }15\text{V}$		0.4	4	mV
ΔV_O	Load regulation	$I_O = 0\text{ to }1.5\text{A}$, $T_J = 25^\circ\text{C}$		0.5	8	mV
		$I_O = 0\text{ to }1.5\text{A}$		1	16	mV
V_d	Dropout voltage	$I_O = 1.5\text{A}$		1.3	1.5	V
I_q	Quiescent current	$V_I \leq 30\text{V}$		5	10	mA
I_{sc}	Short circuit current	$V_I - V_O = 5\text{V}$	1.5	2		A
		$V_I - V_O = 25\text{V}$	0.05	0.02		A
	Thermal regulation	$T_A = 25^\circ\text{C}$, 30ms pulse		0.01	0.04	%/W
SVR	Supply voltage rejection	$f = 120\text{ Hz}$, $C_O = 25\ \mu\text{F}$, $I_O = 1.5\text{A}$ $V_I = 6.5 \pm 3\text{V}$	60	82		dB
eN	RMS Output noise voltage (% of V_O)	$T_A = 25^\circ\text{C}$, $f = 10\text{Hz to }10\text{kHz}$		0.003		%
S	Temperature stability			0.5		%
S	Long term stability	$T_A = 125^\circ\text{C}$, 1000Hrs		0.5		%

1. See short-circuit current curve for available output current at fixed dropout.

Table 5. Electrical characteristics of LD1086#18(V_I = 4.8 V, C_I = C_O = 10 μF, T_A = -40 to 125 °C, unless otherwise specified).

Symbol	Parameter	Test condition	Min.	Typ.	Max.	Unit
V _O	Output voltage ⁽¹⁾	I _O = 0 mA, T _J = 25°C	1.782	1.8	1.818	V
		I _O = 0 to 1.5A, V _I = 3.4 to 30V	1.764	1.8	1.836	V
ΔV _O	Line regulation	I _O = 0 mA, V _I = 3.4 to 18V, T _J = 25°C		0.2	4	mV
		I _O = 0 mA, V _I = 3.4 to 15V		0.4	4	mV
ΔV _O	Load regulation	I _O = 0 to 1.5A, T _J = 25°C		0.5	8	mV
		I _O = 0 to 1.5A		1	16	mV
V _d	Dropout voltage	I _O = 1.5A		1.3	1.5	V
I _q	Quiescent current	V _I ≤ 30V		5	10	mA
I _{sc}	Short circuit current	V _I - V _O = 5V	1.5	2		A
		V _I - V _O = 25V	0.05	0.02		A
	Thermal regulation	T _A = 25°C, 30ms pulse		0.01	0.04	%/W
SVR	Supply voltage rejection	f = 120 Hz, C _O = 25 μF, I _O = 1.5A V _I = 6.8 ± 3V	60	82		dB
eN	RMS Output noise voltage (% of V _O)	T _A = 25°C, f = 10Hz to 10kHz		0.003		%
S	Temperature stability			0.5		%
S	Long term stability	T _A = 125°C, 1000Hrs		0.5		%

1. See short-circuit current curve for available output current at fixed dropout.

Table 6. Electrical characteristics of LD1086#25
 ($V_I = 5.5\text{ V}$, $C_I = C_O = 10\ \mu\text{F}$, $T_A = -40\text{ to }125\text{ }^\circ\text{C}$, unless otherwise specified).

Symbol	Parameter	Test condition	Min.	Typ.	Max.	Unit
V_O	Output voltage ⁽¹⁾	$I_O = 0\text{ mA}$, $T_J = 25^\circ\text{C}$	2.475	2.5	2.525	V
		$I_O = 0\text{ to }1.5\text{ A}$, $V_I = 4.1\text{ to }30\text{ V}$	2.45	2.5	2.55	V
ΔV_O	Line regulation	$I_O = 0\text{ mA}$, $V_I = 4.1\text{ to }18\text{ V}$, $T_J = 25^\circ\text{C}$		0.2	4	mV
		$I_O = 0\text{ mA}$, $V_I = 4.1\text{ to }18\text{ V}$		0.4	4	mV
ΔV_O	Load regulation	$I_O = 0\text{ to }1.5\text{ A}$, $T_J = 25^\circ\text{C}$		0.5	8	mV
		$I_O = 0\text{ to }1.5\text{ A}$		1	16	mV
V_d	Dropout voltage	$I_O = 1.5\text{ A}$		1.3	1.5	V
I_q	Quiescent current	$V_I \leq 30\text{ V}$		5	10	mA
I_{sc}	Short circuit current	$V_I - V_O = 5\text{ V}$	1.5	2		A
		$V_I - V_O = 25\text{ V}$	0.05	0.2		A
	Thermal regulation	$T_A = 25^\circ\text{C}$, 30ms pulse		0.008	0.04	%/W
SVR	Supply voltage rejection	$f = 120\text{ Hz}$, $C_O = 25\ \mu\text{F}$, $I_O = 1.5\text{ A}$ $V_I = 7.5 \pm 3\text{ V}$	60	81		dB
eN	RMS Output noise voltage (% of V_O)	$T_A = 25^\circ\text{C}$, $f = 10\text{ Hz to }10\text{ kHz}$		0.003		%
S	Temperature stability			0.5		%
S	Long term stability	$T_A = 125^\circ\text{C}$, 1000Hrs		0.5		%

1. See short-circuit current curve for available output current at fixed dropout.

Table 7. Electrical characteristics of LD1086#33
 ($V_I = 6.3\text{ V}$, $C_I = C_O = 10\ \mu\text{F}$, $T_A = -40\text{ to }125\text{ }^\circ\text{C}$, unless otherwise specified).

Symbol	Parameter	Test condition	Min.	Typ.	Max.	Unit
V_O	Output voltage ⁽¹⁾	$I_O = 0\text{ mA}$, $T_J = 25^\circ\text{C}$	3.267	3.3	3.333	V
		$I_O = 0\text{ to }1.5\text{ A}$, $V_I = 4.9\text{ to }30\text{ V}$	3.234	3.3	3.366	V
ΔV_O	Line regulation	$I_O = 0\text{ mA}$, $V_I = 4.9\text{ to }18\text{ V}$, $T_J = 25^\circ\text{C}$		0.5	6	mV
		$I_O = 0\text{ mA}$, $V_I = 4.9\text{ to }18\text{ V}$		1	6	mV
ΔV_O	Load regulation	$I_O = 0\text{ to }1.5\text{ A}$, $T_J = 25^\circ\text{C}$		1	10	mV
		$I_O = 0\text{ to }1.5\text{ A}$		7	25	mV
V_d	Dropout voltage	$I_O = 1.5\text{ A}$		1.3	1.5	V
I_q	Quiescent current	$V_I \leq 30\text{ V}$		5	10	mA
I_{sc}	Short circuit current	$V_I - V_O = 5\text{ V}$	1.5	2		A
		$V_I - V_O = 25\text{ V}$	0.05	0.2		A
	Thermal regulation	$T_A = 25^\circ\text{C}$, 30ms pulse		0.008	0.04	%/W
SVR	Supply voltage rejection	$f = 120\text{ Hz}$, $C_O = 25\ \mu\text{F}$, $I_O = 1.5\text{ A}$ $V_I = 8.3 \pm 3\text{ V}$	60	79		dB
eN	RMS Output noise voltage (% of V_O)	$T_A = 25^\circ\text{C}$, $f = 10\text{ Hz to }10\text{ kHz}$		0.003		%
S	Temperature stability			0.5		%
S	Long term stability	$T_A = 125^\circ\text{C}$, 1000Hrs		0.5		%

1. See short-circuit current curve for available output current at fixed dropout.

Table 8. Electrical characteristics of LD1086#36
 ($V_I = 6.6\text{ V}$, $C_I = C_O = 10\ \mu\text{F}$, $T_A = -40\text{ to }125\text{ }^\circ\text{C}$, unless otherwise specified).

Symbol	Parameter	Test condition	Min.	Typ.	Max.	Unit
V_O	Output voltage ⁽¹⁾	$I_O = 0\text{ mA}$, $T_J = 25^\circ\text{C}$	3.564	3.6	3.636	V
		$I_O = 0\text{ to }1.5\text{ A}$, $V_I = 5.2\text{ to }30\text{ V}$	3.528	3.6	3.672	V
ΔV_O	Line regulation	$I_O = 0\text{ mA}$, $V_I = 5.2\text{ to }18\text{ V}$, $T_J = 25^\circ\text{C}$		0.5	10	mV
		$I_O = 0\text{ mA}$, $V_I = 5.2\text{ to }18\text{ V}$		1	10	mV
ΔV_O	Load regulation	$I_O = 0\text{ to }1.5\text{ A}$, $T_J = 25^\circ\text{C}$		3	15	mV
		$I_O = 0\text{ to }1.5\text{ A}$		7	25	mV
V_d	Dropout voltage	$I_O = 1.5\text{ A}$		1.3	1.5	V
I_q	Quiescent current	$V_I \leq 30\text{ V}$		5	10	mA
I_{sc}	Short circuit current	$V_I - V_O = 5\text{ V}$	1.5	2		A
		$V_I - V_O = 25\text{ V}$	0.05	0.2		A
	Thermal regulation	$T_A = 25^\circ\text{C}$, 30ms pulse		0.01	0.04	%/W
SVR	Supply voltage rejection	$f = 120\text{ Hz}$, $C_O = 25\ \mu\text{F}$, $I_O = 1.5\text{ A}$ $V_I = 8.6 \pm 3\text{ V}$	60	78		dB
eN	RMS Output noise voltage (% of V_O)	$T_A = 25^\circ\text{C}$, $f = 10\text{ Hz to }10\text{ kHz}$		0.003		%
S	Temperature stability			0.5		%
S	Long term stability	$T_A = 125^\circ\text{C}$, 1000Hrs		0.5		%

1. See short-circuit current curve for available output current at fixed dropout.

Table 9. Electrical characteristics of LD1086#50
($V_I = 8\text{ V}$, $C_I = C_O = 10\ \mu\text{F}$, $T_A = -40\text{ to }125\text{ }^\circ\text{C}$, unless otherwise specified).

Symbol	Parameter	Test condition	Min.	Typ.	Max.	Unit
V_O	Output voltage ⁽¹⁾	$I_O = 0\text{ mA}$, $T_J = 25^\circ\text{C}$	4.95	5	5.05	V
		$I_O = 0\text{ to }1.5\text{ A}$, $V_I = 6.6\text{ to }30\text{ V}$	4.9	5	5.1	V
ΔV_O	Line regulation	$I_O = 0\text{ mA}$, $V_I = 6.6\text{ to }20\text{ V}$, $T_J = 25^\circ\text{C}$		0.5	10	mV
		$I_O = 0\text{ mA}$, $V_I = 6.6\text{ to }20\text{ V}$		1	10	mV
ΔV_O	Load regulation	$I_O = 0\text{ to }1.5\text{ A}$, $T_J = 25^\circ\text{C}$		5	20	mV
		$I_O = 0\text{ to }1.5\text{ A}$		10	35	mV
V_d	Dropout voltage	$I_O = 1.5\text{ A}$		1.3	1.5	V
I_q	Quiescent current	$V_I \leq 30\text{ V}$		5	10	mA
I_{sc}	Short circuit current	$V_I - V_O = 5\text{ V}$	1.5	2		A
		$V_I - V_O = 25\text{ V}$	0.05	0.2		A
	Thermal regulation	$T_A = 25^\circ\text{C}$, 30ms pulse		0.01	0.04	%/W
SVR	Supply voltage rejection	$f = 120\text{ Hz}$, $C_O = 25\ \mu\text{F}$, $I_O = 1.5\text{ A}$ $V_I = 10 \pm 3\text{ V}$	60	75		dB
eN	RMS Output noise voltage (% of V_O)	$T_A = 25^\circ\text{C}$, $f = 10\text{ Hz to }10\text{ kHz}$		0.003		%
S	Temperature stability			0.5		%
S	Long term stability	$T_A = 125^\circ\text{C}$, 1000Hrs		0.5		%

1. See short-circuit current curve for available output current at fixed dropout.

Table 10. Electrical characteristics of LD1086#80(V_I = 11 V, C_I = C_O = 10 μF, T_A = -40 to 125 °C, unless otherwise specified).

Symbol	Parameter	Test condition	Min.	Typ.	Max.	Unit
V _O	Output voltage ⁽¹⁾	I _O = 0 mA, T _J = 25°C	7.92	8	8.08	V
		I _O = 0 to 1.5A, V _I = 9.8 to 30V	7.84	8	8.16	V
ΔV _O	Line regulation	I _O = 0 mA, V _I = 9.8 to 20V, T _J = 25°C		1	18	mV
		I _O = 0 mA, V _I = 9.8 to 20V		2	18	mV
ΔV _O	Load regulation	I _O = 0 to 1.5A, T _J = 25°C		8	30	mV
		I _O = 0 to 1.5A		12	60	mV
V _d	Dropout voltage	I _O = 1.5A		1.3	1.5	V
I _q	Quiescent current	V _I ≤ 30V		5	10	mA
I _{sc}	Short circuit current	V _I - V _O = 5V	1.5	2		A
		V _I - V _O = 25V	0.04	0.2		A
	Thermal regulation	T _A = 25°C, 30ms pulse		0.01	0.04	%/W
SVR	Supply voltage rejection	f = 120 Hz, C _O = 25 μF, I _O = 1.5A V _I = 13 ± 3V	54	71		dB
eN	RMS Output noise voltage (% of V _O)	T _A = 25°C, f = 10Hz to 10kHz		0.003		%
S	Temperature stability			0.5		%
S	Long term stability	T _A = 125°C, 1000Hrs		0.5		%

1. See short-circuit current curve for available output current at fixed dropout.

Table 11. Electrical characteristics of LD1086#12(V_I = 15 V, C_I = C_O = 10 μF, T_A = -40 to 125 °C, unless otherwise specified).

Symbol	Parameter	Test condition	Min.	Typ.	Max.	Unit
V _O	Output voltage ⁽¹⁾	I _O = 0 mA, T _J = 25°C	11.88	12	12.12	V
		I _O = 0 to 1.5A, V _I = 13.8 to 30V	11.76	12	12.24	V
ΔV _O	Line regulation	I _O = 0 mA, V _I = 13.8 to 25V, T _J = 25°C		1	25	mV
		I _O = 0 mA, V _I = 13.8 to 25V		2	25	mV
ΔV _O	Load regulation	I _O = 0 to 1.5A, T _J = 25°C		12	36	mV
		I _O = 0 to 1.5A		24	72	mV
V _d	Dropout voltage	I _O = 1.5A		1.3	1.5	V
I _q	Quiescent current	V _I ≤ 30V		5	10	mA
I _{sc}	Short circuit current	V _I - V _O = 5V	1.5	2		A
		V _I - V _O = 25V	0.05	0.2		A
	Thermal regulation	T _A = 25°C, 30ms pulse		0.01	0.04	%/W
SVR	Supply voltage rejection	f = 120 Hz, C _O = 25 μF, I _O = 1.5A V _I = 17 ± 3V	54	66		dB
eN	RMS Output noise voltage (% of V _O)	T _A = 25°C, f = 10Hz to 10kHz		0.003		%
S	Temperature stability			0.5		%
S	Long term stability	T _A = 125°C, 1000Hrs		0.5		%

1. See short-circuit current curve for available output current at fixed dropout.

Table 12. Electrical characteristics of LD1086#(V_I = 4.25 V, C_I = C_O = 10 μF, T_A = -40 to 125 °C, unless otherwise specified).

Symbol	Parameter	Test condition	Min.	Typ.	Max.	Unit
V _O	Output voltage ⁽¹⁾	I _O = 10mA T _J = 25°C	1.237	1.25	1.263	V
		I _O = 10mA to 1.5A, V _I = 2.85 to 30V	1.225	1.25	1.275	V
ΔV _O	Line Regulation	I _O = 10mA, V _I = 2.8 to 16.5V, T _J = 25°C		0.015	0.2	%
		I _O = 10mA, V _I = 2.8 to 16.5V		0.035	0.2	%
ΔV _O	Load Regulation	I _O = 10mA to 1.5A, T _J = 25°C		0.1	0.3	%
		I _O = 0 to 1.5A		0.2	0.4	%
V _d	Dropout Voltage	I _O = 1.5A		1.3	1.5	V
I _{O(min)}	Minimum Load Current	V _I = 30V		3	10	mA
I _{sc}	Short Circuit Current	V _I - V _O = 5V	1.5	2.3		A
		V _I - V _O = 25V	0.05	0.2		A
	Thermal Regulation	T _A = 25°C, 30ms pulse		0.01	0.04	%/W
SVR	Supply Voltage Rejection	f = 120 Hz, C _O = 25 μF, C _{ADJ} = 25 μF, I _O = 1.5A, V _I = 6.25 ± 3V	60	88		dB
I _{ADJ}	Adjust Pin Current	V _I = 4.25V, I _O = 10 mA		40	120	μA
ΔI _{ADJ}	Adjust Pin Current Change ⁽¹⁾	I _O = 10mA to 1.5A, V _I = 2.8 to 16.5V		0.2	5	μA
eN	RMS Output Noise Voltage (% of V _O)	T _A = 25°C, f = 10Hz to 10kHz		0.003		%
S	Temperature Stability			0.5		%
S	Long Term Stability	T _A = 125°C, 1000Hrs		0.5		%

1. See short-circuit current curve for available output current at fixed dropout.

Table 13. Electrical characteristics of LD1086DTTRY and LD1086VY (Automotive Grade)
 ($V_I = 4.25\text{ V}$, $C_I = C_O = 10\ \mu\text{F}$, $T_A = -40\text{ to }125\text{ }^\circ\text{C}$, unless otherwise specified).

Symbol	Parameter	Test condition	Min.	Typ.	Max.	Unit
V_O	Output voltage ⁽¹⁾	$I_O = 10\text{ mA}$, $T_A = 25^\circ\text{C}$	1.237	1.25	1.263	V
		$I_O = 10\text{ mA to }1.5\text{ A}$, $V_I = 2.85\text{ to }30\text{ V}$	1.225	1.25	1.275	V
ΔV_O	Line regulation	$I_O = 10\text{ mA}$, $V_I = 2.8\text{ to }16.5\text{ V}$		0.035	0.2	%
ΔV_O	Load regulation	$I_O = 0\text{ to }1.5\text{ A}$		0.2	0.4	%
V_d	Dropout voltage	$I_O = 1.5\text{ A}$		1.3	1.5	V
$I_{O(\text{min})}$	Minimum load current	$V_I = 30\text{ V}$		3	10	mA
I_{sc}	Short circuit current	$V_I - V_O = 5\text{ V}$, $T_A = 25^\circ\text{C}$	1.5	2.3		A
		$V_I - V_O = 25\text{ V}$, $T_A = 25^\circ\text{C}$	0.05	0.2		A
	Thermal regulation	$T_A = 25^\circ\text{C}$, 30ms pulse		0.01	0.04	%/W
SVR	Supply voltage rejection	$f = 120\text{ Hz}$, $C_O = 25\ \mu\text{F}$, $C_{ADJ} = 25\ \mu\text{F}$, $I_O = 1.5\text{ A}$, $V_I = 6.25 \pm 3\text{ V}$, $T_A = 25^\circ\text{C}$	60	88		dB
I_{ADJ}	Adjust pin current	$V_I = 4.25\text{ V}$, $I_O = 10\text{ mA}$		40	120	μA
ΔI_{ADJ}	Adjust pin current change ⁽¹⁾	$I_O = 10\text{ mA to }1.5\text{ A}$, $V_I = 2.8\text{ to }16.5\text{ V}$		0.2	5	μA
eN	RMS output noise voltage (% of V_O)	$T_A = 25^\circ\text{C}$, $f = 10\text{ Hz to }10\text{ KHz}$		0.003		%
S	Temperature stability			0.5		%
S	Long term stability	$T_A = 125^\circ\text{C}$, 1000 Hrs		0.5		%

1. See short-circuit current curve for available output current at fixed dropout.

6 Typical application

(Unless otherwise specified $T_J = 25\text{ }^\circ\text{C}$, $C_I = C_O = 10\text{ }\mu\text{F}$)

Figure 4. Output voltage vs temperature

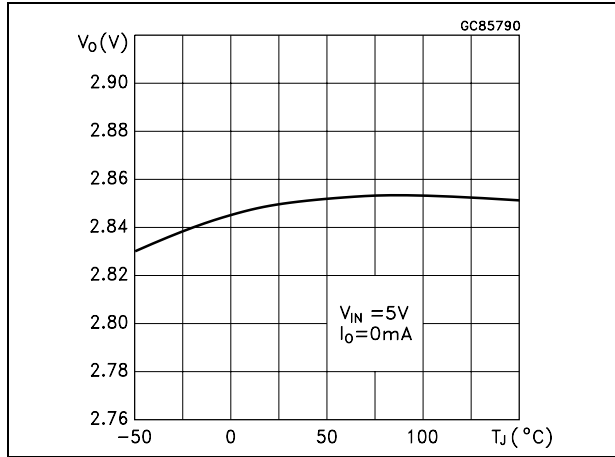

Figure 5. Output voltage vs temperature

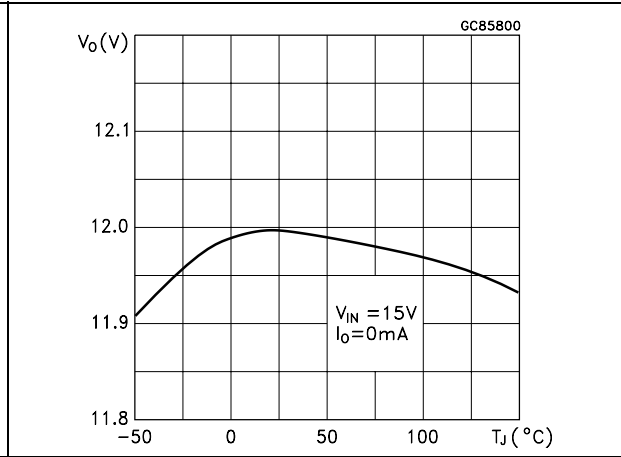

Figure 6. Output voltage vs temperature

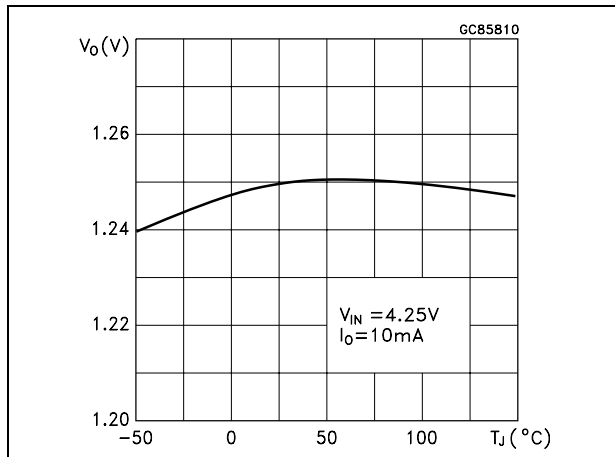

Figure 7. Short circuit current vs dropout voltage

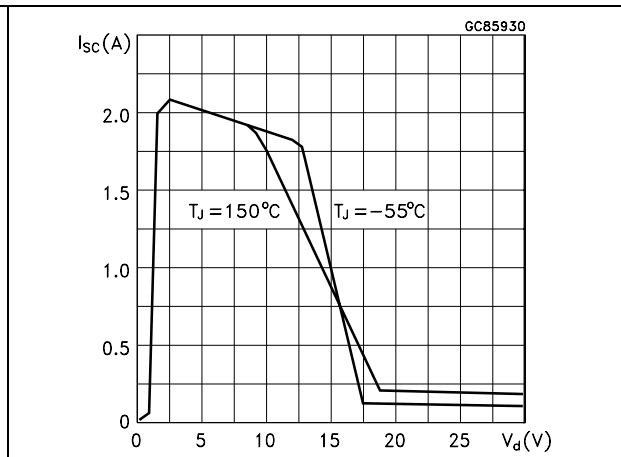

Figure 8. Line regulation vs temperature

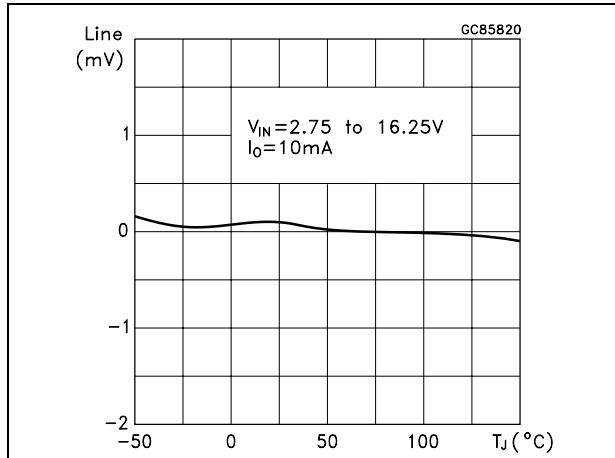

Figure 9. Load regulation vs temperature

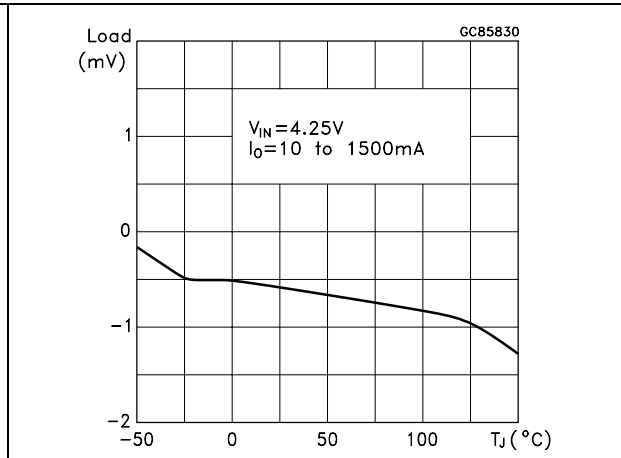

Figure 10. Dropout voltage vs temperature

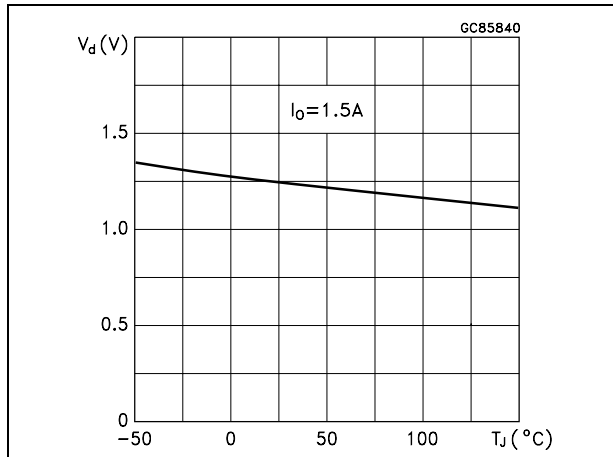

Figure 11. Dropout voltage vs output current

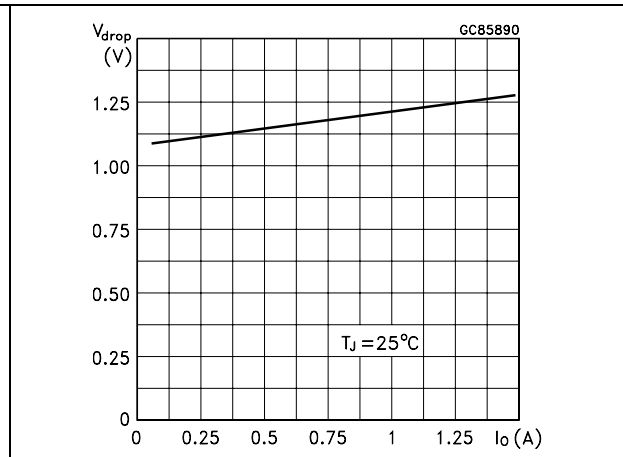

Figure 12. Adjust pin current vs input voltage

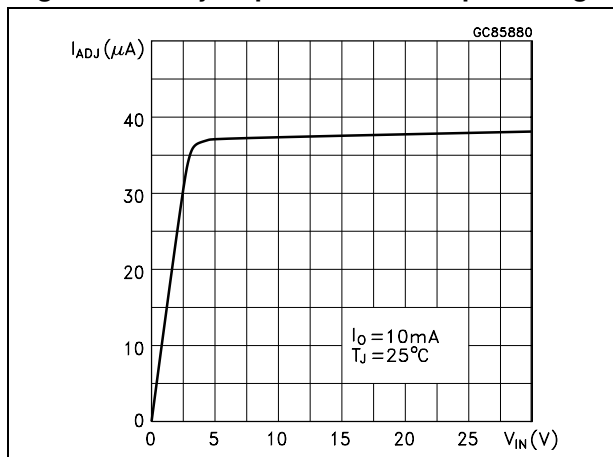

Figure 13. Adjust pin current vs temperature

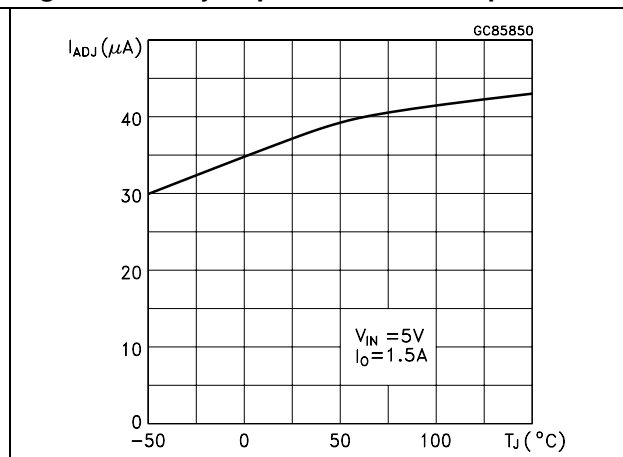

Figure 14. Adjust pin current vs output current

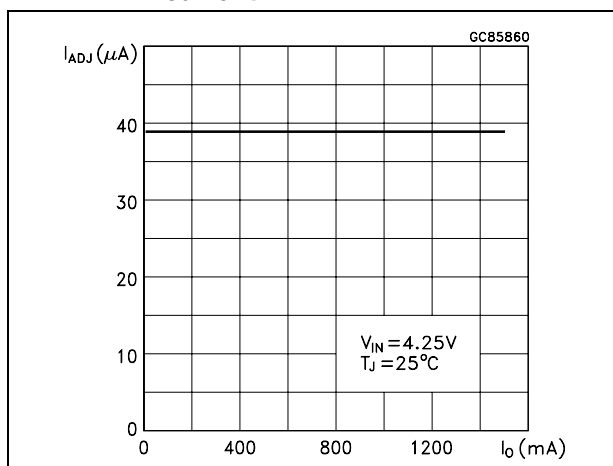

Figure 15. Quiescent current vs output current

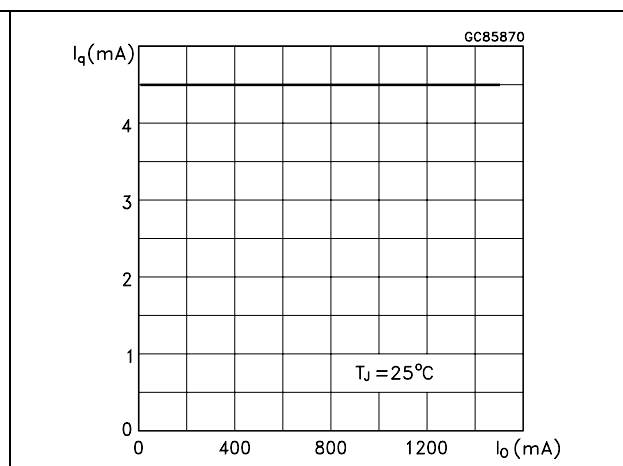

Figure 16. Quiescent current vs input voltage

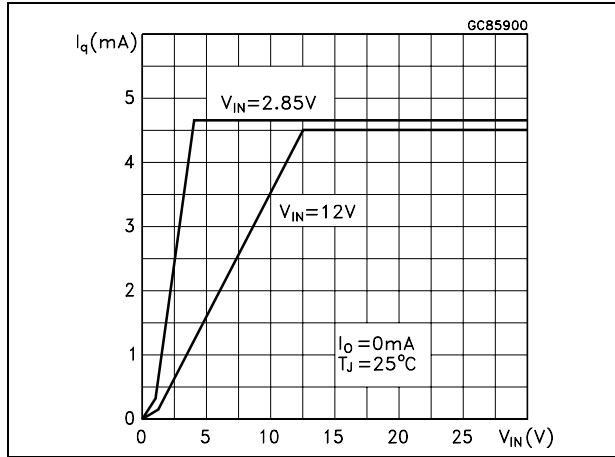

Figure 17. Supply voltage rejection vs output current

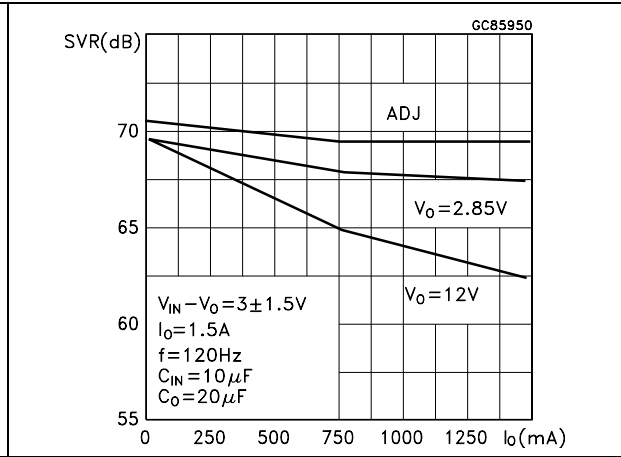

Figure 18. Supply voltage rejection vs frequency

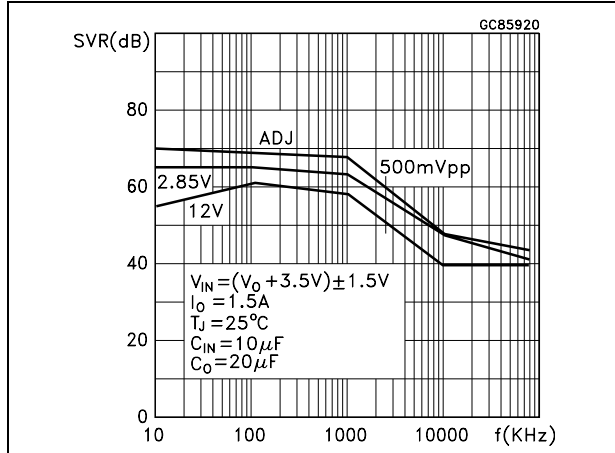

Figure 19. Supply voltage rejection vs temperature

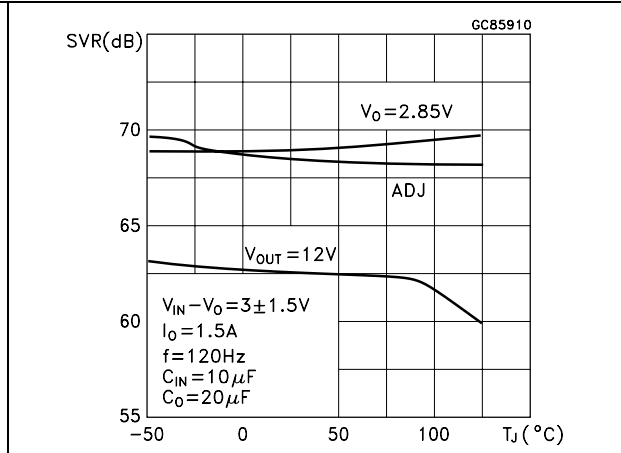

Figure 20. Minimum load current vs temperature

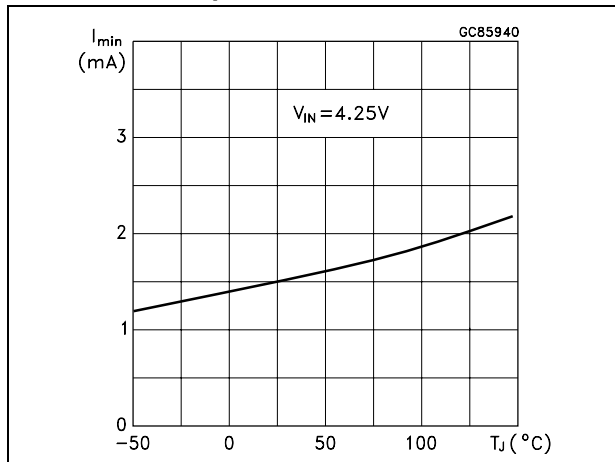

Figure 21. Stability for adjustable

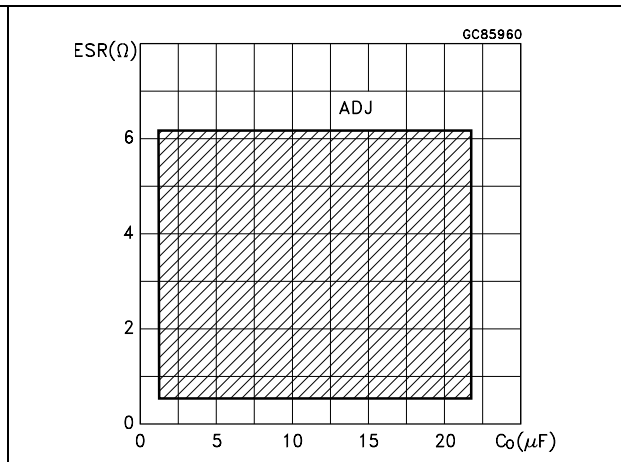

Figure 22. Stability for 2.85V

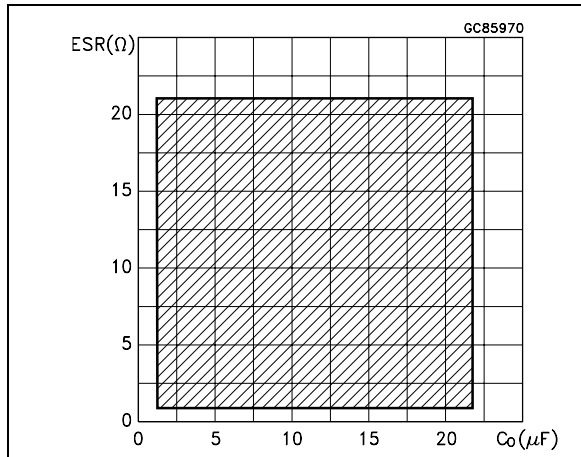

Figure 23. Stability for 12V

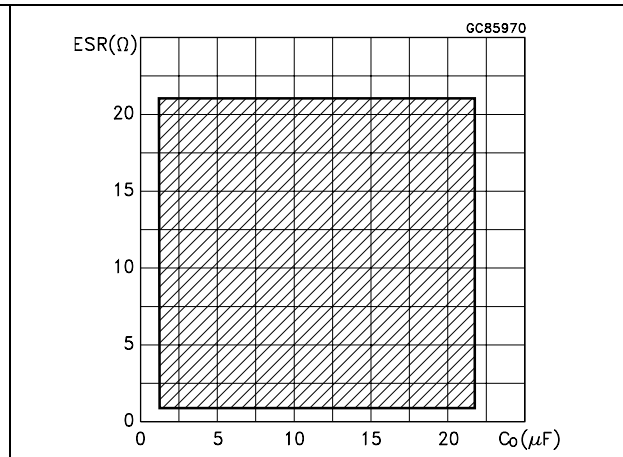

Figure 24. Line transient

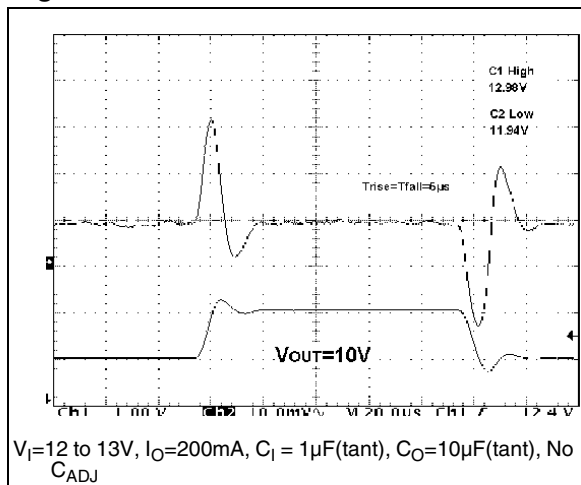

Figure 25. Line transient

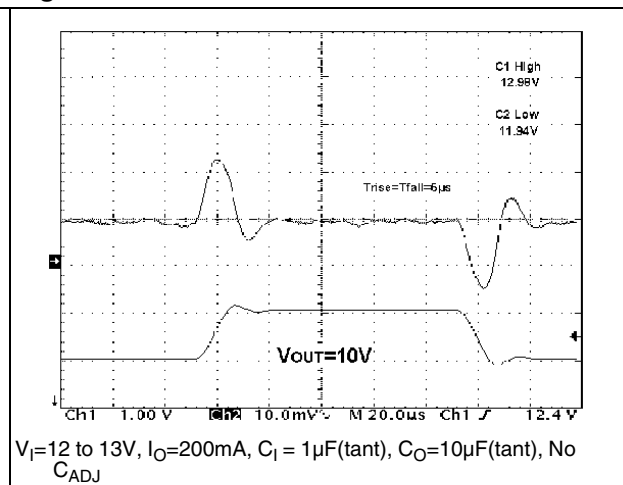

Figure 26. Line transient

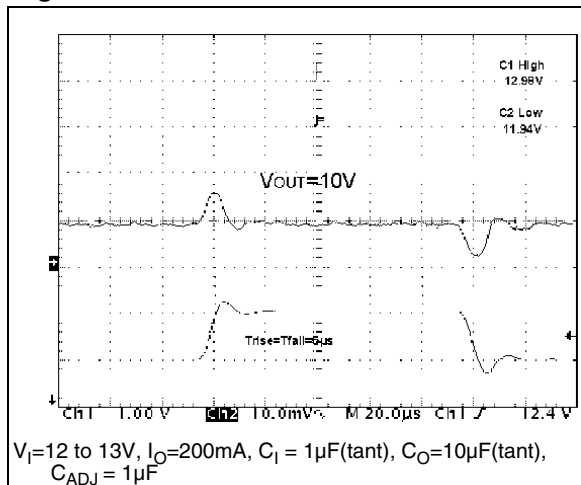

Figure 27. Load transient

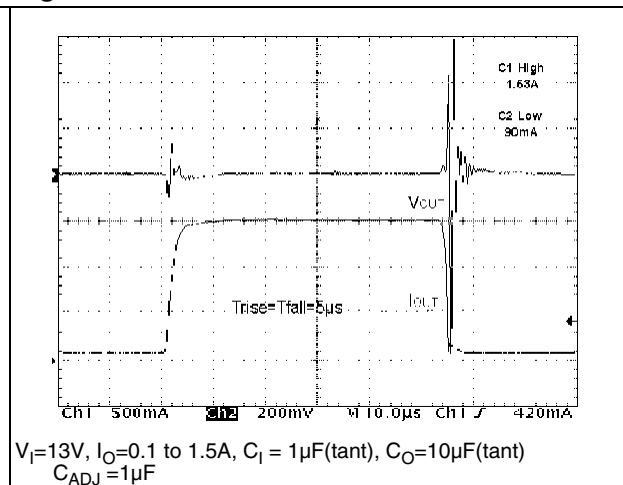

Figure 28. Load transient

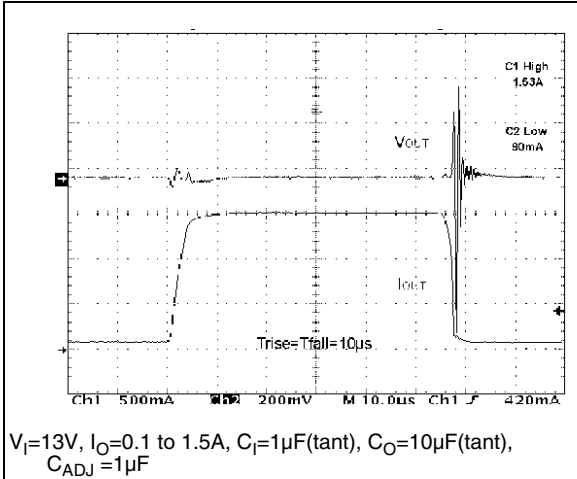
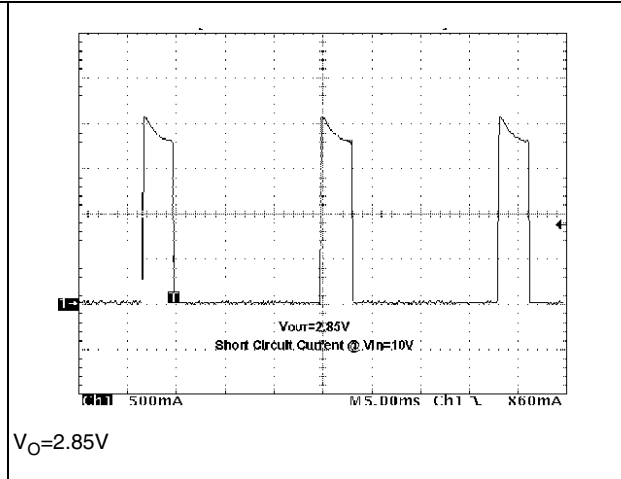

Figure 29. Thermal protection



7 Package mechanical data

In order to meet environmental requirements, ST offers these devices in ECOPACK[®] packages. These packages have a lead-free second level interconnect. The category of second Level Interconnect is marked on the package and on the inner box label, in compliance with JEDEC Standard JESD97. The maximum ratings related to soldering conditions are also marked on the inner box label. ECOPACK is an ST trademark. ECOPACK specifications are available at: www.st.com.

TO-220 mechanical data

Dim.	mm.			inch.		
	Min.	Typ.	Max.	Min.	Typ.	Max.
A	4.40		4.60	0.173		0.181
C	1.23		1.32	0.048		0.051
D	2.40		2.72	0.094		0.107
D1		1.27			0.050	
E	0.49		0.70	0.019		0.027
F	0.61		0.88	0.024		0.034
F1	1.14		1.70	0.044		0.067
F2	1.14		1.70	0.044		0.067
G	4.95		5.15	0.194		0.203
G1	2.4		2.7	0.094		0.106
H2	10.0		10.40	0.393		0.409
L2		16.4			0.645	
L4	13.0		14.0	0.511		0.551
L5	2.65		2.95	0.104		0.116
L6	15.25		15.75	0.600		0.620
L7	6.2		6.6	0.244		0.260
L9	3.5		3.93	0.137		0.154
DIA.	3.75		3.85	0.147		0.151

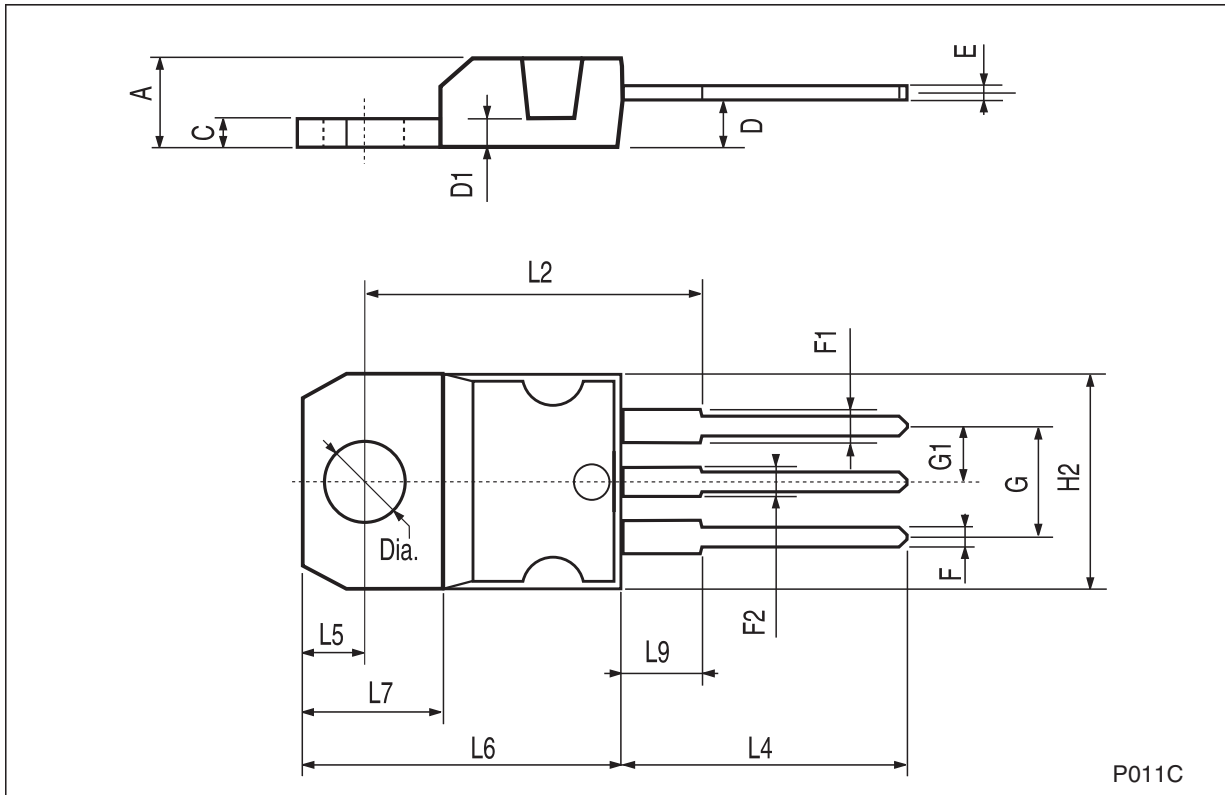

DPAK mechanical data

Dim.	mm.			inch.		
	Min.	Typ.	Max.	Min.	Typ.	Max.
A	2.2		2.4	0.086		0.094
A1	0.9		1.1	0.035		0.043
A2	0.03		0.23	0.001		0.009
B	0.64		0.9	0.025		0.035
b4	5.2		5.4	0.204		0.212
C	0.45		0.6	0.017		0.023
C2	0.48		0.6	0.019		0.023
D	6		6.2	0.236		0.244
D1		5.1			0.200	
E	6.4		6.6	0.252		0.260
E1		4.7			0.185	
e		2.28			0.090	
e1	4.4		4.6	0.173		0.181
H	9.35		10.1	0.368		0.397
L	1			0.039		
(L1)		2.8			0.110	
L2		0.8			0.031	
L4	0.6		1	0.023		0.039
R		0.2			0.008	
V2	0°		8°	0°		8°

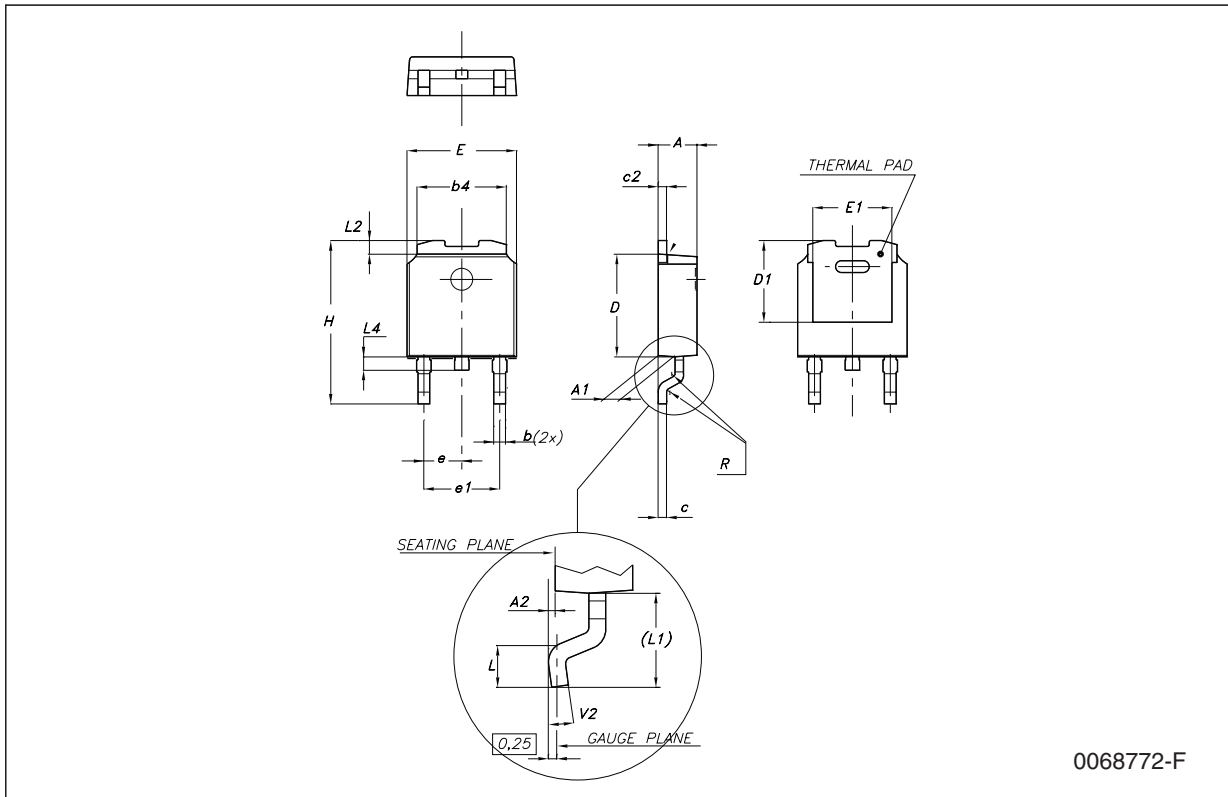

0068772-F

Figure 30. Drawing dimension D²PAK (type STD-ST)

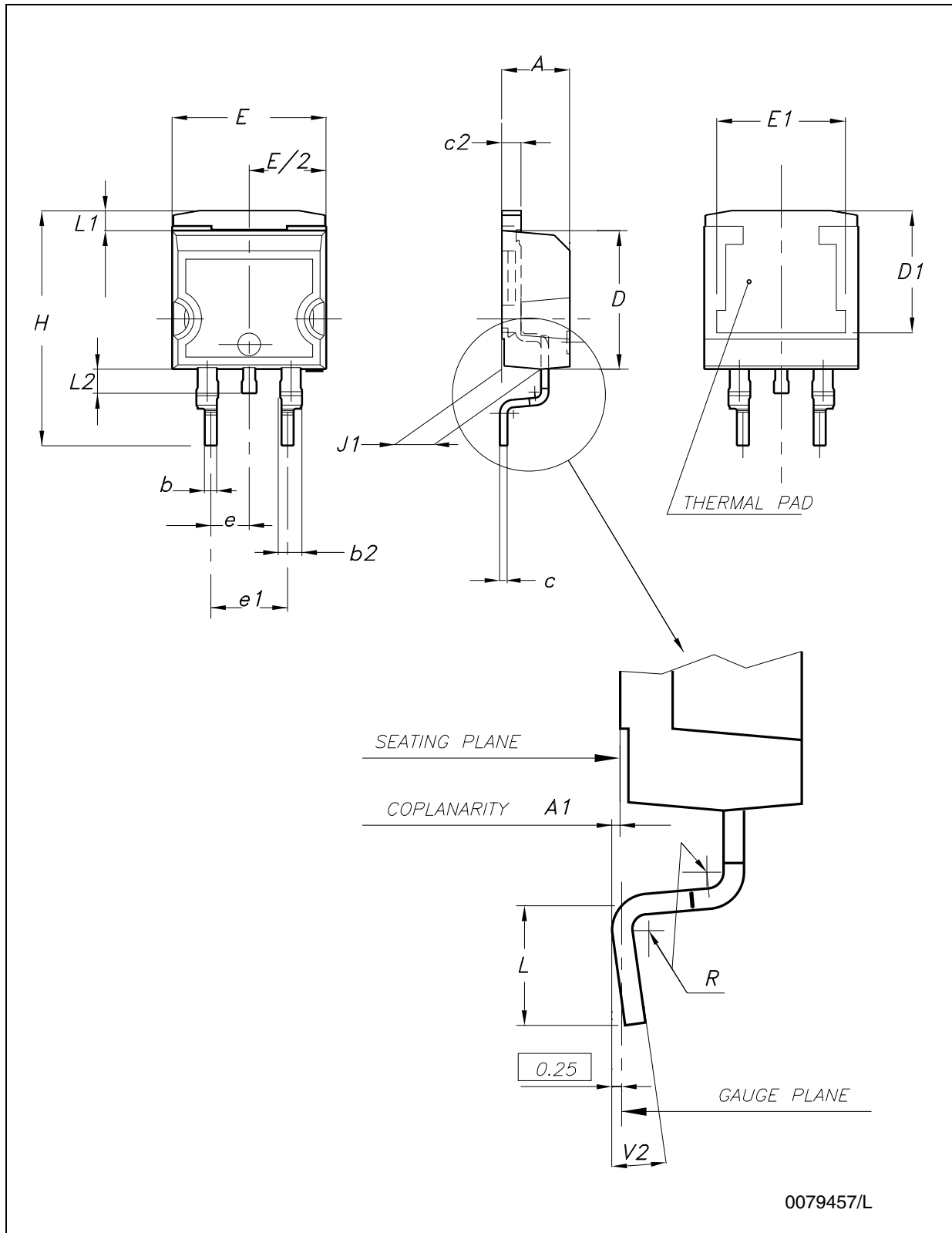

Figure 31. Drawing dimension D²PAK (type WOOSEOK-SUBCON.)

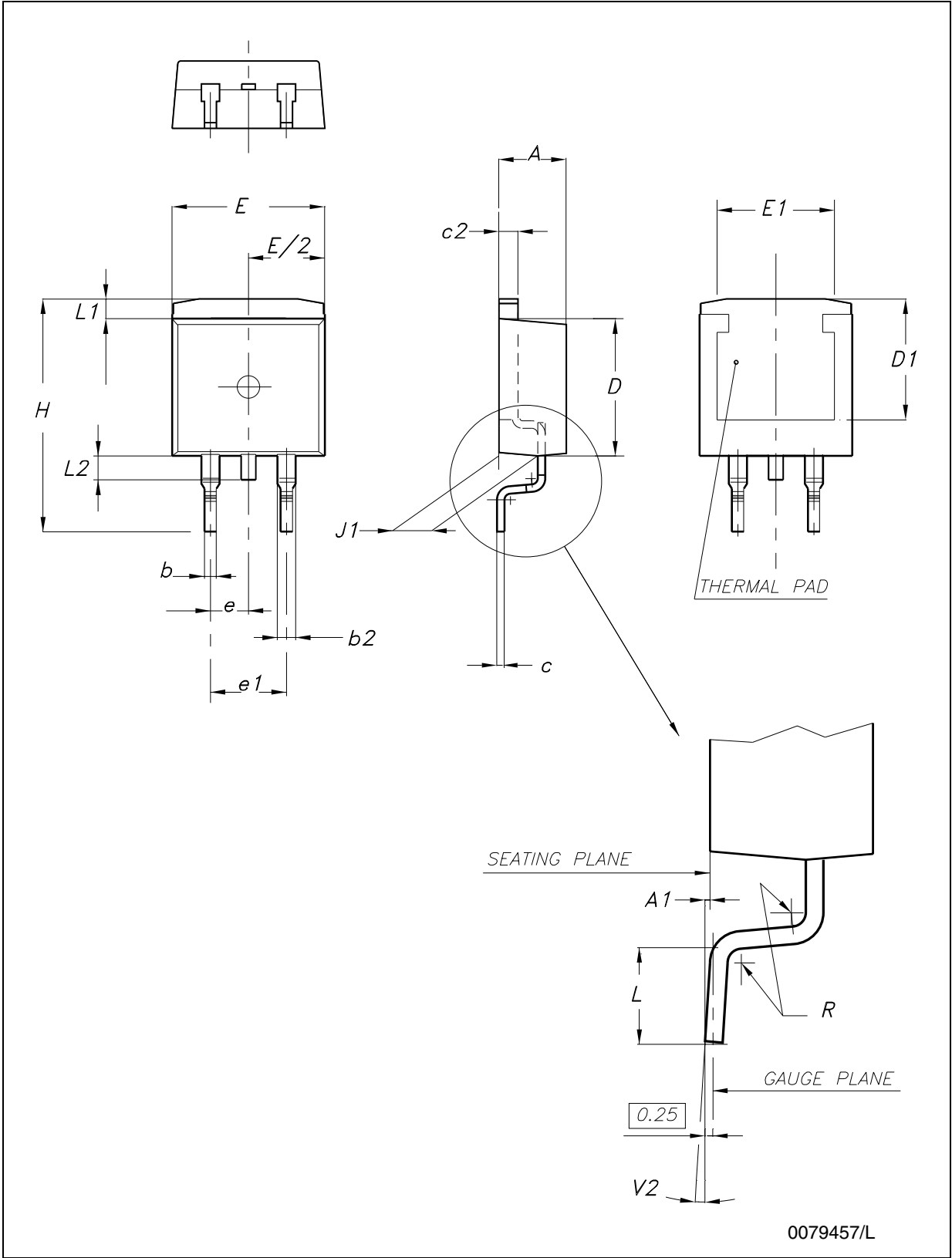

Table 14. D²PAK mechanical data

Dim.	Type STD-ST			Type WOOSEOK-SUBCON.		
	mm.			mm.		
	Min.	Typ.	Max.	Min.	Typ.	Max.
A	4.40		4.60	4.30		4.70
A1	0.03		0.23	0		0.20
b	0.70		0.93	0.70		0.90
b2	1.14		1.70	1.17		1.37
c	0.45		0.60	0.45	0.50	0.60
c2	1.23		1.36	1.25	1.30	1.40
D	8.95		9.35	9	9.20	9.40
D1	7.50			7.50		
E	10		10.40	9.80		10.20
E1	8.50			7.50		
e		2.54			2.54	
e1	4.88		5.28		5.08	
H	15		15.85	15	15.30	15.60
J1	2.49		2.69	2.20		2.60
L	2.29		2.79	1.79		2.79
L1	1.27		1.40	1		1.40
L2	1.30		1.75	1.20		1.60
R		0.4			0.30	
V2	0°		8°	0°		3°

Note: The D²PAK package coming from the subcontractor Wooseok is fully compatible with the ST's package suggested footprint.

Figure 32. D²PAK footprint recommended data

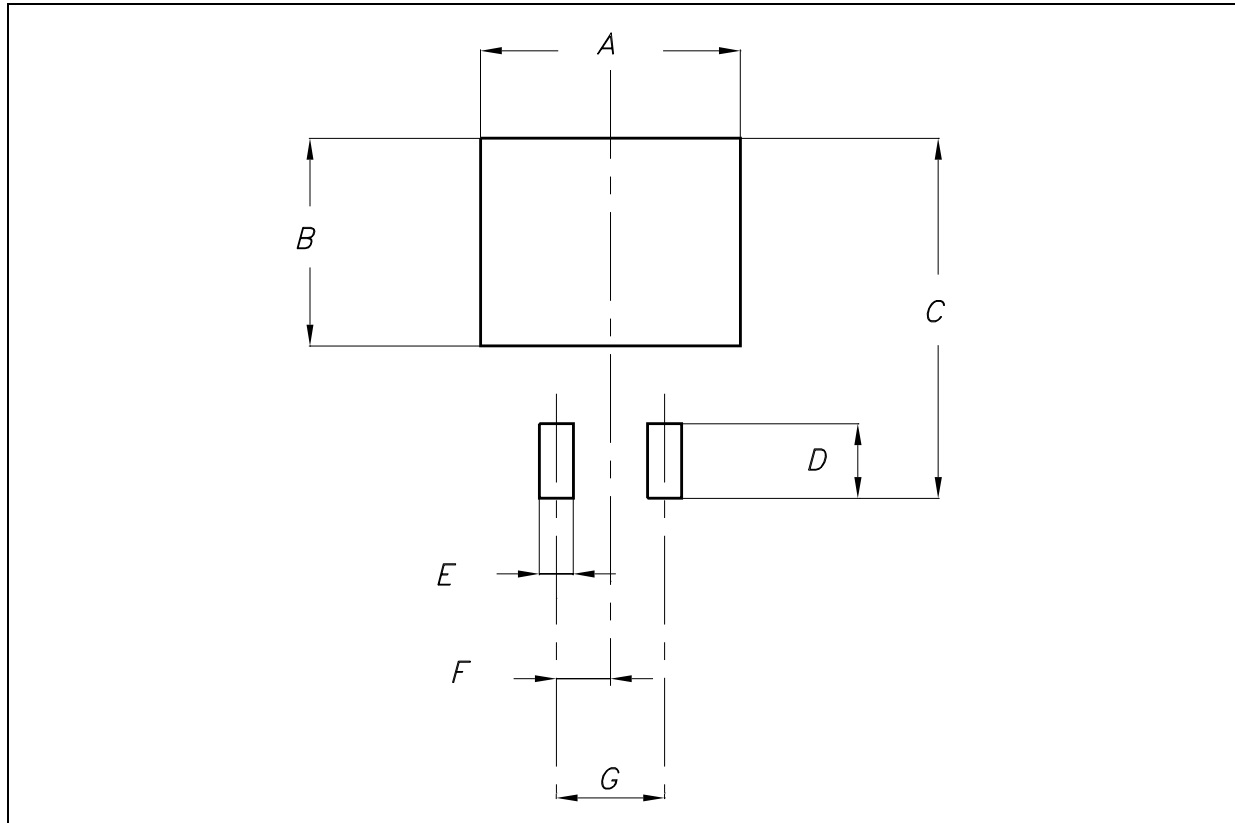

Table 15. Footprint data

	Values	
	mm.	inch.
A	12.20	0.480
B	9.75	0.384
C	16.90	0.665
D	3.50	0.138
E	1.60	0.063
F	2.54	0.100
G	5.08	0.200

Figure 33. Drawing dimension D²PAK/A (type STD-ST)

Figure 34. Drawing dimension D²PAK/A (type WOOSEOK-Subcon.)



7106164/E

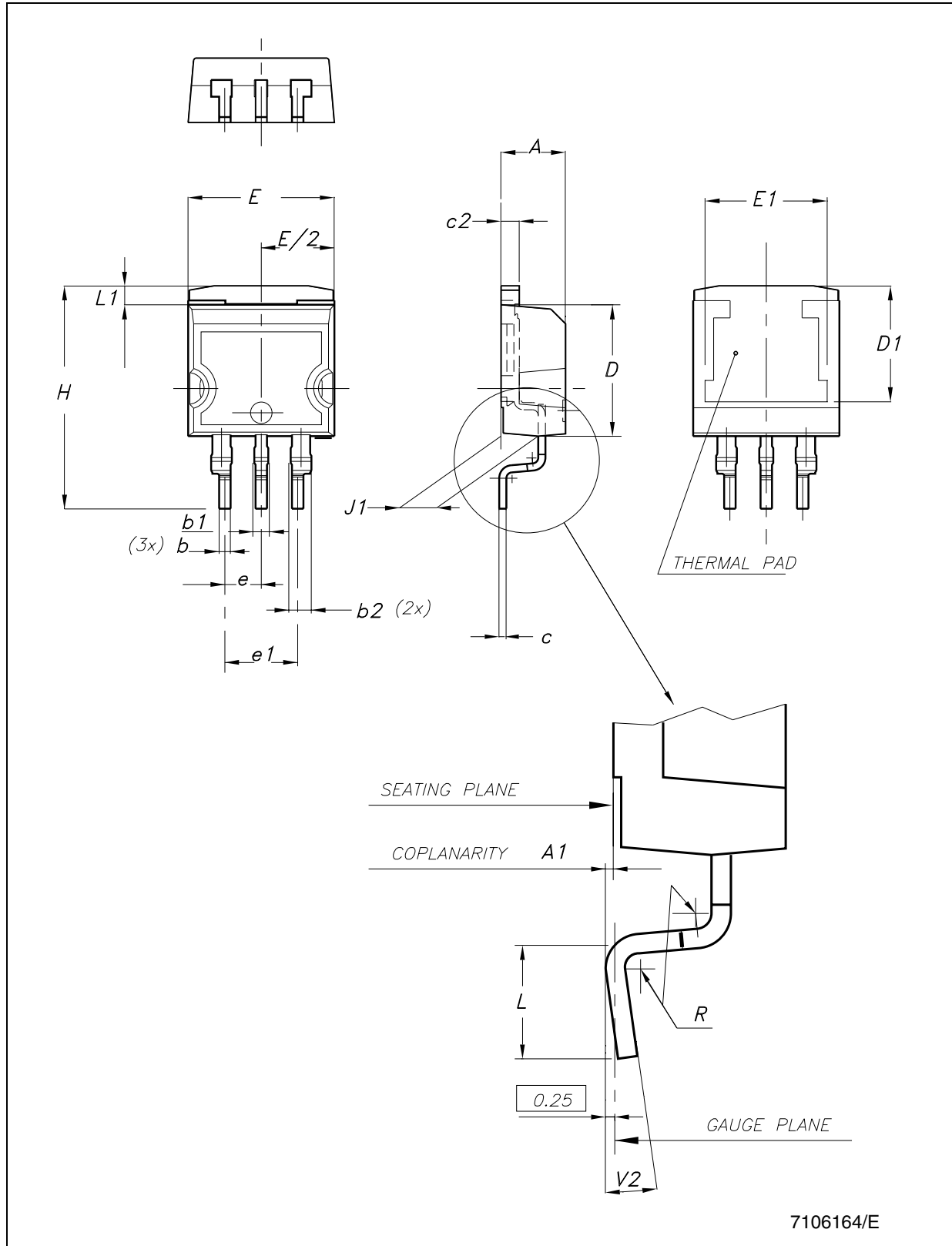
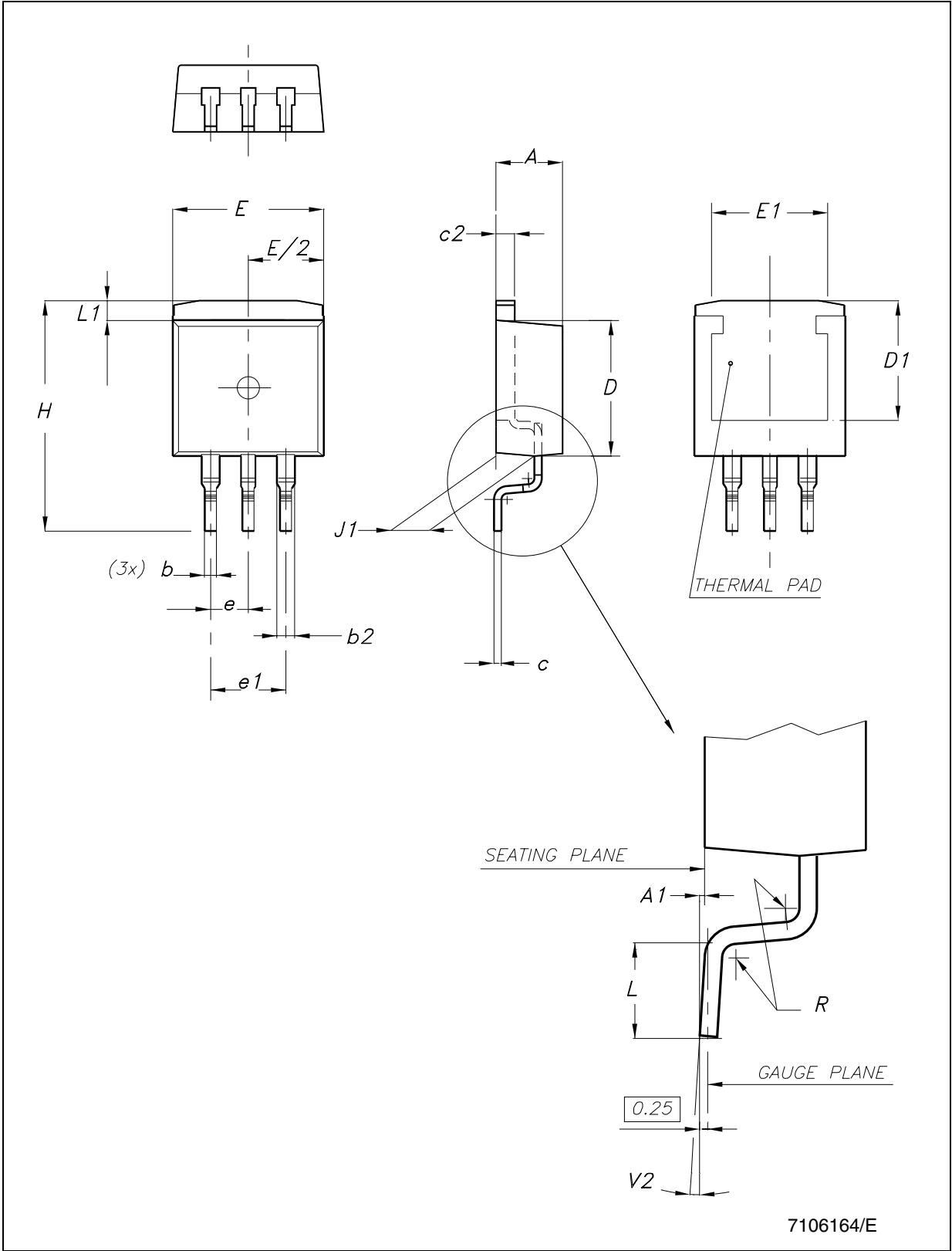

Table 16. D²PAK/A mechanical data

Dim.	Type STD-ST			Type WOOSEOK-Subcon.		
	mm.			mm.		
	Min.	Typ.	Max.	Min.	Typ.	Max.
A	4.40		4.60	4.30		4.70
A1	0.03		0.23	0		0.20
b	0.70		0.93	0.70		0.90
b1	0.80		1.30			
b2	1.14		1.70	1.17		1.37
c	0.45		0.60	0.45	0.50	0.60
c2	1.23		1.36	1.25	1.30	1.40
D	8.95		9.35	9	9.20	9.40
D1	7.50			7.50		
E	10		10.40	9.80		10.20
E1	8.50			7.50		
e		2.54			2.54	
e1	4.88		5.28		5.08	
H	15		15.85	15	15.30	15.60
J1	2.49		2.69	2.20		2.60
L	2.29		2.79	1.79		2.79
L1	1.27		1.40	1		1.40
R		0.4			0.30	
V2	0°		8°	0°		3°

Note: The D²PAK/A package coming from the subcontractor Wooseok is fully compatible with the ST's package suggested footprint.

Figure 35. D²PAK/A footprint recommended data

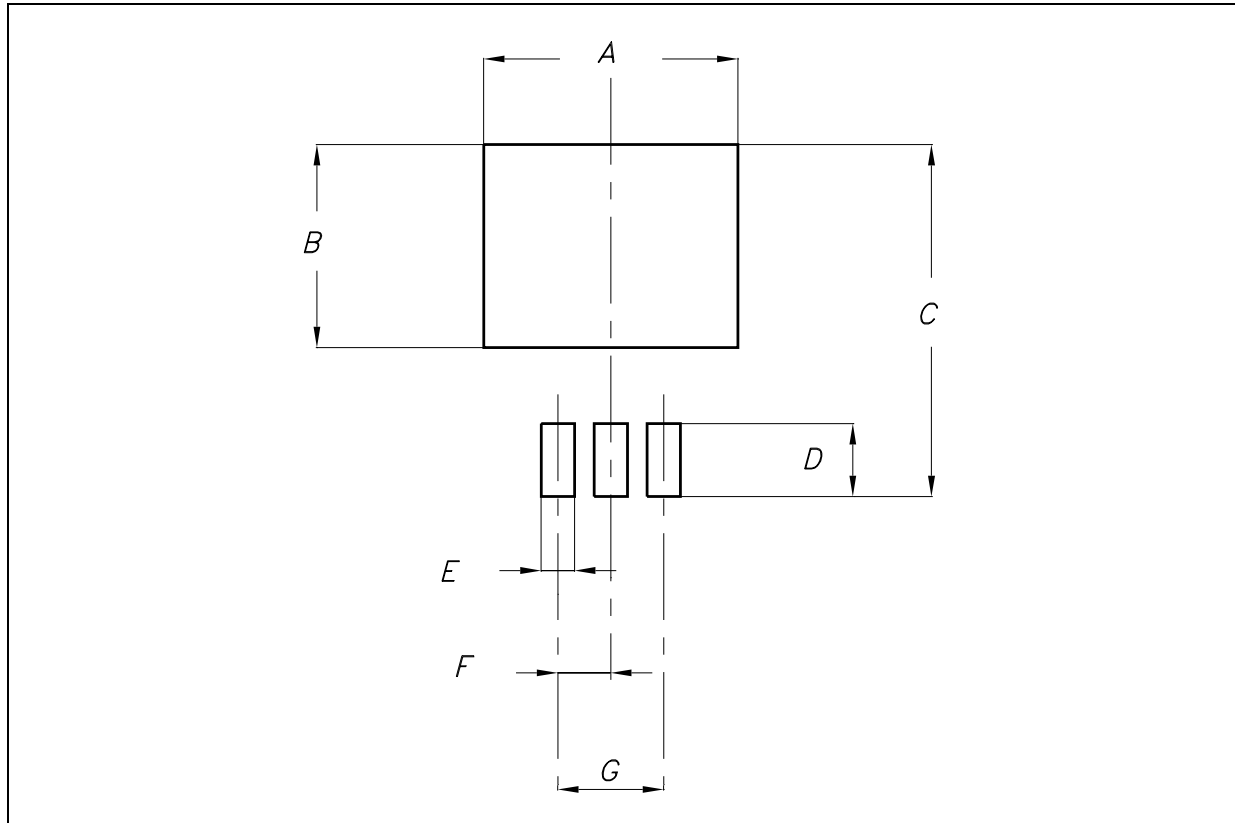
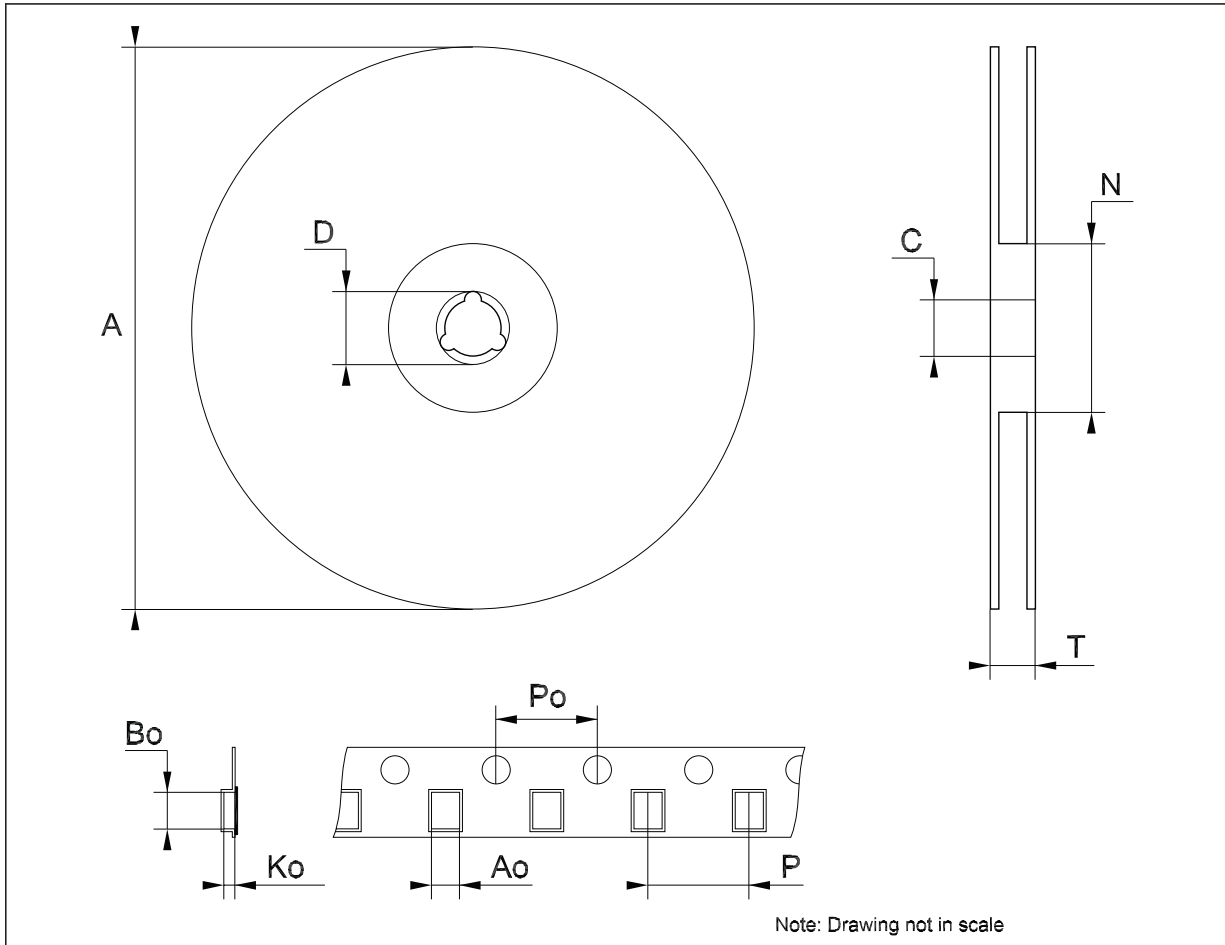

Table 17. Footprint data

	Values	
	mm.	inch.
A	12.20	0.480
B	9.75	0.384
C	16.90	0.665
D	3.50	0.138
E	1.60	0.063
F	2.54	0.100
G	5.08	0.200

Tape & reel DPAK-PPAK mechanical data

Dim.	mm.			inch.		
	Min.	Typ.	Max.	Min.	Typ.	Max.
A			330			12.992
C	12.8	13.0	13.2	0.504	0.512	0.519
D	20.2			0.795		
N	60			2.362		
T			22.4			0.882
Ao	6.80	6.90	7.00	0.268	0.272	0.276
Bo	10.40	10.50	10.60	0.409	0.413	0.417
Ko	2.55	2.65	2.75	0.100	0.104	0.105
Po	3.9	4.0	4.1	0.153	0.157	0.161
P	7.9	8.0	8.1	0.311	0.315	0.319



Tape & reel D²PAK-P²PAK-D²PAK/A-P²PAK/A mechanical data

Dim.	mm.			inch.		
	Min.	Typ.	Max.	Min.	Typ.	Max.
A			180			7.086
C	12.8	13.0	13.2	0.504	0.512	0.519
D	20.2			0.795		
N	60			2.362		
T			14.4			0.567
Ao	10.50	10.6	10.70	0.413	0.417	0.421
Bo	15.70	15.80	15.90	0.618	0.622	0.626
Ko	4.80	4.90	5.00	0.189	0.193	0.197
Po	3.9	4.0	4.1	0.153	0.157	0.161
P	11.9	12.0	12.1	0.468	0.472	0.476

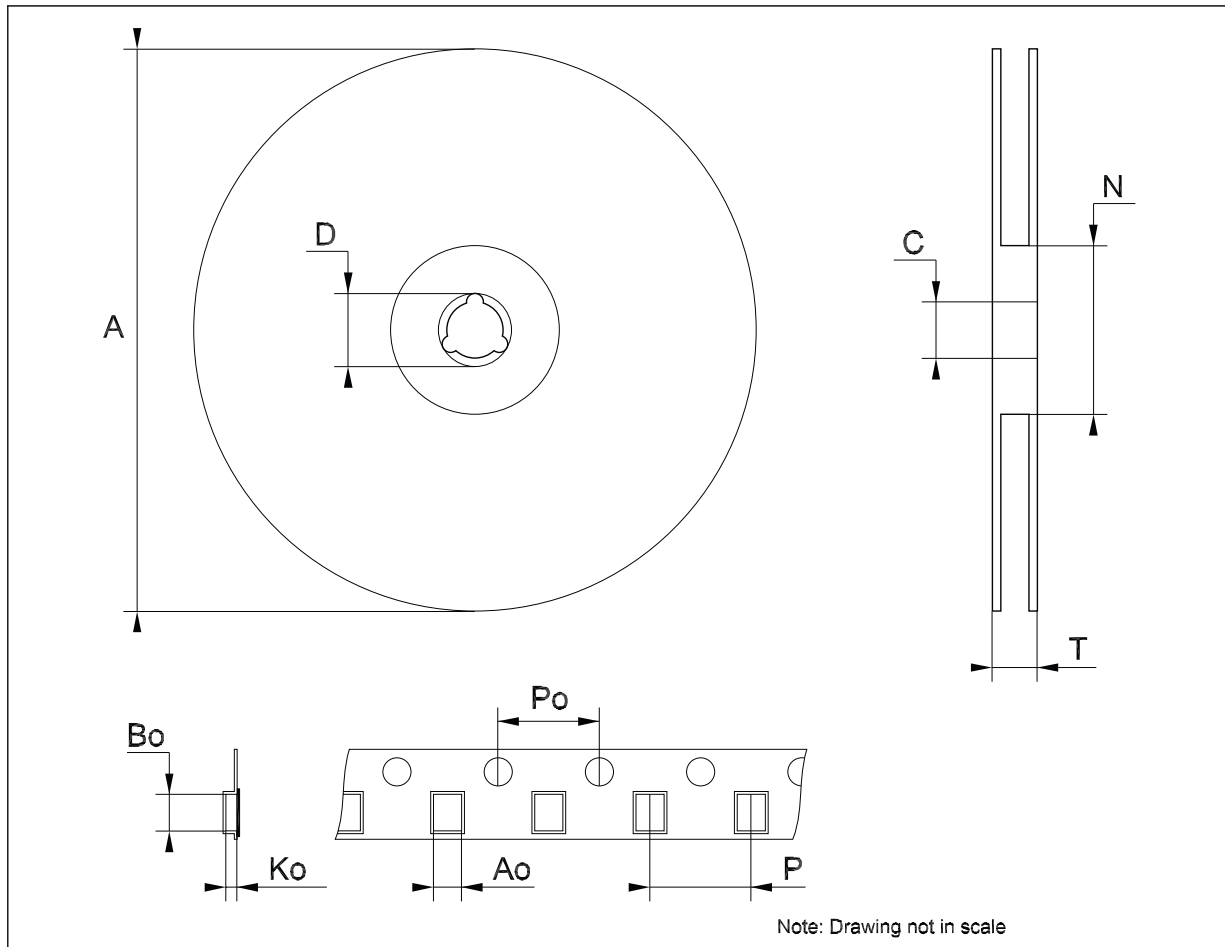

8 Order codes

Table 18. Order codes

Packages				
TO-220	D ² PAK	D ² PAK/A	DPAK	Output voltage
	LD1086D2T15R		LD1086DT15R	1.5 V
LD1086V18	LD1086D2T18TR		LD1086DT18TR	1.8 V
LD1086V25	LD1086D2T25TR		LD1086DT25TR	2.5 V
LD1086V33	LD1086D2T33TR	LD1086D2M33TR	LD1086DT33TR	3.3 V
LD1086V36				3.6 V
	LD1086D2T50TR		LD1086DT50TR	5.0 V
LD1086V80	LD1086D2T80TR		LD1086DT80TR	8.0 V
LD1086V12	LD1086D2T12TR			12.0 V
LD1086V	LD1086D2TTR	LD1086D2MTR	LD1086DTTR	ADJ
LD1086VY ⁽¹⁾			LD1086DTTRY ⁽¹⁾	ADJ

1. Automotive Grade products.

9 Revision history

Table 19. Document revision history

Date	Revision	Changes
25-Aug-2004	11	Mistake V_O (typ.), table 9 - pag. 6.
07-Oct-2004	12	Mistake order codes - Table 1.
08-Feb-2005	13	Mistake U.M. Load regulation - $V \implies$ mV.
16-May-2006	14	Order codes updated and new template.
19-Jan-2007	15	D ² PAK mechanical data updated and add footprint data.
05-Apr-2007	16	Order codes updated.
07-Jun-2007	17	Order codes updated.
19-Jul-2007	18	Add note on Figure 2 .
03-Dec-2007	19	Modified: Table 18 .
31-Jan-2008	20	Added new order codes for Automotive grade products.
18-Feb-2008	21	Modified: Table 18 on page 37 .

Please Read Carefully:

Information in this document is provided solely in connection with ST products. STMicroelectronics NV and its subsidiaries ("ST") reserve the right to make changes, corrections, modifications or improvements, to this document, and the products and services described herein at any time, without notice.

All ST products are sold pursuant to ST's terms and conditions of sale.

Purchasers are solely responsible for the choice, selection and use of the ST products and services described herein, and ST assumes no liability whatsoever relating to the choice, selection or use of the ST products and services described herein.

No license, express or implied, by estoppel or otherwise, to any intellectual property rights is granted under this document. If any part of this document refers to any third party products or services it shall not be deemed a license grant by ST for the use of such third party products or services, or any intellectual property contained therein or considered as a warranty covering the use in any manner whatsoever of such third party products or services or any intellectual property contained therein.

UNLESS OTHERWISE SET FORTH IN ST'S TERMS AND CONDITIONS OF SALE ST DISCLAIMS ANY EXPRESS OR IMPLIED WARRANTY WITH RESPECT TO THE USE AND/OR SALE OF ST PRODUCTS INCLUDING WITHOUT LIMITATION IMPLIED WARRANTIES OF MERCHANTABILITY, FITNESS FOR A PARTICULAR PURPOSE (AND THEIR EQUIVALENTS UNDER THE LAWS OF ANY JURISDICTION), OR INFRINGEMENT OF ANY PATENT, COPYRIGHT OR OTHER INTELLECTUAL PROPERTY RIGHT.

UNLESS EXPRESSLY APPROVED IN WRITING BY AN AUTHORIZED ST REPRESENTATIVE, ST PRODUCTS ARE NOT RECOMMENDED, AUTHORIZED OR WARRANTED FOR USE IN MILITARY, AIR CRAFT, SPACE, LIFE SAVING, OR LIFE SUSTAINING APPLICATIONS, NOR IN PRODUCTS OR SYSTEMS WHERE FAILURE OR MALFUNCTION MAY RESULT IN PERSONAL INJURY, DEATH, OR SEVERE PROPERTY OR ENVIRONMENTAL DAMAGE. ST PRODUCTS WHICH ARE NOT SPECIFIED AS "AUTOMOTIVE GRADE" MAY ONLY BE USED IN AUTOMOTIVE APPLICATIONS AT USER'S OWN RISK.

Resale of ST products with provisions different from the statements and/or technical features set forth in this document shall immediately void any warranty granted by ST for the ST product or service described herein and shall not create or extend in any manner whatsoever, any liability of ST.

ST and the ST logo are trademarks or registered trademarks of ST in various countries.

Information in this document supersedes and replaces all information previously supplied.

The ST logo is a registered trademark of STMicroelectronics. All other names are the property of their respective owners.

© 2008 STMicroelectronics - All rights reserved

STMicroelectronics group of companies

Australia - Belgium - Brazil - Canada - China - Czech Republic - Finland - France - Germany - Hong Kong - India - Israel - Italy - Japan - Malaysia - Malta - Morocco - Singapore - Spain - Sweden - Switzerland - United Kingdom - United States of America

www.st.com

