

High-speed low power triple operational amplifier

Features

- Low supply current: 4.5 mA
- High-speed: 150 MHz - 110 V/ μ s
- Unity gain stability
- Low offset voltage: 4 mV
- Low noise: 4.2 nV/ \sqrt Hz
- Low cost
- Specified for 600 Ω and 150 Ω loads
- High video performance:
 - Differential gain: 0.03%
 - Differential phase: 0.07°
 - Gain flatness: 6 MHz, 0.1 dB max. at 10 dB gain
- High audio performance
- ESD tolerance: 2 kV

Applications

- Set-top boxes
- TVs
- DVD players

Description

The TSH93 is a triple low-power high-frequency op-amp, designed for high quality video signal processing. The device offers an excellent speed consumption ratio with 4.5 mA per amplifier for a 150 MHz bandwidth.

A high slew rate and low noise make it also suitable for high-quality audio applications.

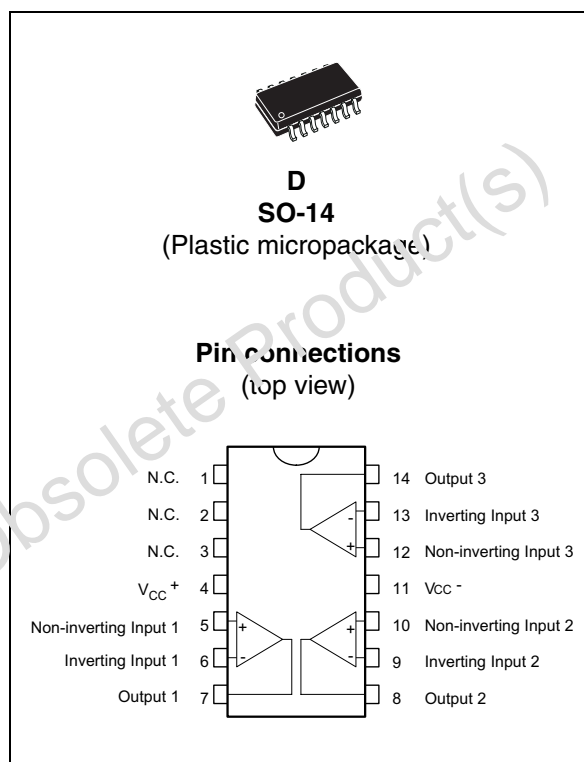

1 Absolute maximum ratings and operating conditions

Table 1. Absolute maximum ratings (AMR)

Symbol	Parameter	Value	Unit
V_{CC}	Supply voltage ⁽¹⁾	14	V
V_{id}	Differential input voltage ⁽²⁾	±5	V
V_i	Input voltage ⁽³⁾	-0.3 to 12	V
T_{oper}	Operating free-air temperature range	-40 to +125	°C
T_{stg}	Storage temperature range	-65 to +150	°C
ESD	CDM: charged device model ⁽⁴⁾	1.5	kV
	HBM: human body model ⁽⁵⁾	2	kV
	MM: machine model ⁽⁶⁾	200	V

- All voltage values, except differential voltage, are with respect to network ground terminal.
- Differential voltages are the non-inverting input terminal with respect to the inverting input terminal.
- The magnitude of input and output voltages must never exceed $V_{CC} + 0.3$ V.
- Charged device model: all pins and package are charged together to the specified voltage and then discharged directly to the ground through only one pin. This is done for all pins.
- Human body model: a 100 pF capacitor is charged to the specified voltage, then discharged through a 1.5 kΩ resistor between two pins of the device. This is done for all couples of connected pin combinations while the other pins are floating.
- Machine model: a 200 pF capacitor is charged to the specified voltage, then discharged directly between two pins of the device with no external series resistor (internal resistor < 5 Ω). This is done for all couples of connected pin combinations while the other pins are floating.

Table 2. Operating conditions

Symbol	Parameter	Value	Unit
V_{CC}	Supply voltage	7 to 12	V
V_{in}	Common mode input voltage range	$V_{CC}^- + 2$ to $V_{CC}^+ - 1$	V

2 Schematic diagram

Figure 1. Schematic diagram (one channel only)

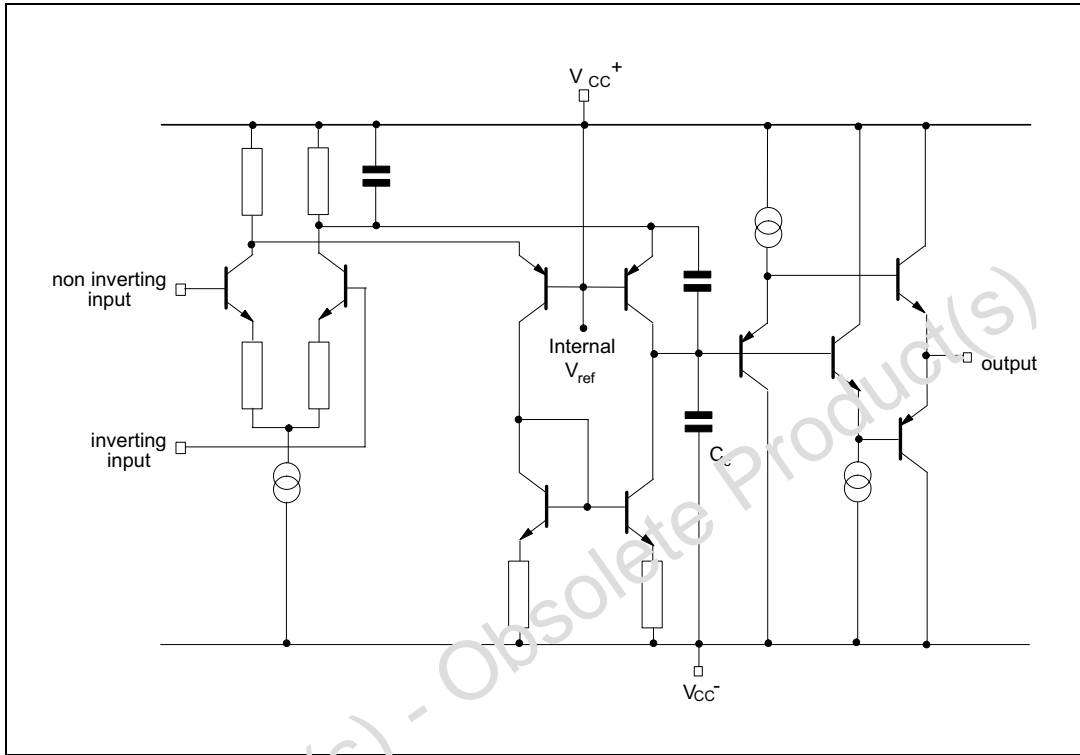

3 Electrical characteristics

Table 3. $V_{CC}^+ = 5\text{ V}$, $V_{CC}^- = -5\text{ V}$, $T_{amb} = 25^\circ\text{ C}$ (unless otherwise specified)

Symbol	Parameter	Min.	Typ.	Max.	Unit
V_{io}	Input offset voltage $T_{min} \leq T_{amb} \leq T_{max}$			4 6	mV
I_{io}	Input offset current $T_{min} \leq T_{amb} \leq T_{max}$		1	2 5	μA
I_{ib}	Input bias current $T_{min} \leq T_{amb} \leq T_{max}$		5	15 20	μA
I_{CC}	Supply current (per amplifier, no load) $T_{min} \leq T_{amb} \leq T_{max}$		4.5	6 8	mA
CMR	Common-mode rejection ratio $V_{ic} = -3\text{ V}$ to $+4\text{ V}$, $V_o = 0\text{ V}$ $T_{min} \leq T_{amb} \leq T_{max}$	80 70	100		dB
SVR	Supply voltage rejection ratio $V_{CC} = \pm 5\text{ V}$ to $\pm 3\text{ V}$ $T_{min} \leq T_{amb} \leq T_{max}$	60 50	75		dB
Avd	Large signal voltage gain $R_L = 100\ \Omega$, $V_o = \pm 2.5\text{ V}$ $T_{min} \leq T_{amb} \leq T_{max}$	57 54	70		dB
V_{OH}	High level output voltage $V_{id} = 1\text{ V}$ $R_L = 600\ \Omega$ $R_L = 150\ \Omega$ $T_{min} \leq T_{amb} \leq T_{max}$ - $R_L = 150\ \Omega$	3 2.5 2.4	3.5 3		V
V_{OL}	Low level output voltage $V_{id} = -1\text{ V}$ $R_L = 600\ \Omega$ $R_L = 150\ \Omega$ $T_{min} \leq T_{amb} \leq T_{max}$ - $R_L = 150\ \Omega$		-3.5 -2.8	-3 -2.5 -2.4	V
I_o	Output short circuit current - $V_{id} = \pm 1\text{ V}$ Source Sink $T_{min} \leq T_{amb} \leq T_{max}$ Source Sink	20 20 15 15	36 40		mA
GBP	Gain bandwidth product $A_{VCL} = 100$, $R_L = 600\ \Omega$, $C_L = 15\text{ pF}$, $f = 7.5\text{ MHz}$	90	150		MHz
f_T	Transition frequency		90		MHz
SR	Slew rate $V_{in} = -2$ to $+2\text{ V}$, $A_{VCL} = +1$, $R_L = 600\ \Omega$, $C_L = 15\text{ pF}$	62	110		V/ μs
e_n	Equivalent input voltage noise $R_s = 50\ \Omega$, $f = 1\text{ kHz}$		4.2		nV/ $\sqrt{\text{Hz}}$
ϕ_m	Phase margin $A_{VM} = +1$		35		Degrees
V_{O1}/V_{O2}	Channel separation $f = 1\text{ MHz}$ to 10 MHz		65		dB
Gf	Gain flatness $f = \text{DC}$ to 6 MHz , $A_{VCL} = 10\text{ dB}$			0.1	dB
THD	Total harmonic distortion $f = 1\text{ kHz}$, $V_o = \pm 2.5\text{ V}$, $R_L = 600\ \Omega$		0.01		%

Table 3. $V_{CC}^+ = 5\text{ V}$, $V_{CC}^- = -5\text{ V}$, $T_{amb} = 25^\circ\text{ C}$ (unless otherwise specified) (continued)

Symbol	Parameter	Min.	Typ.	Max.	Unit
ΔG	Differential gain $f = 3.58\text{ MHz}$, $A_{VCL} = +2$, $R_L = 150\ \Omega$		0.03		%
$\Delta\phi$	Differential phase $f = 3.58\text{ MHz}$, $A_{VCL} = +2$, $R_L = 150\ \Omega$		0.07		Degrees

Table 4. $V_{CC}^+ = \pm 15\text{ V}$, $T_{amb} = 25^\circ\text{ C}$ (unless otherwise specified)

Symbol	Conditions	Value	Unit
V_{io}		0	mV
A_{vd}	$R_L = 600\ \Omega$	3.2	V/mV
I_{CC}	No load / ampli	5.2	mA
V_{icm}		-3 to 4	V
V_{OH}	$R_L = 600\ \Omega$	+3.6	V
V_{OL}	$R_L = 600\ \Omega$	-3.6	V
I_{sink}	$V_o = 0\text{ V}$	40	mA
I_{source}	$V_o = 0\text{ V}$	40	mA
GBP	$R_L = 600\ \Omega$, $C_L = 15\text{ pF}$	147	MHz
SR	$R_L = 600\ \Omega$, $C_L = 15\text{ pF}$	110	V/ μs
ϕ_m	$R_L = 600\ \Omega$, $C_L = 15\text{ pF}$	42	Degrees

Figure 2. Input offset voltage drift vs. temperature

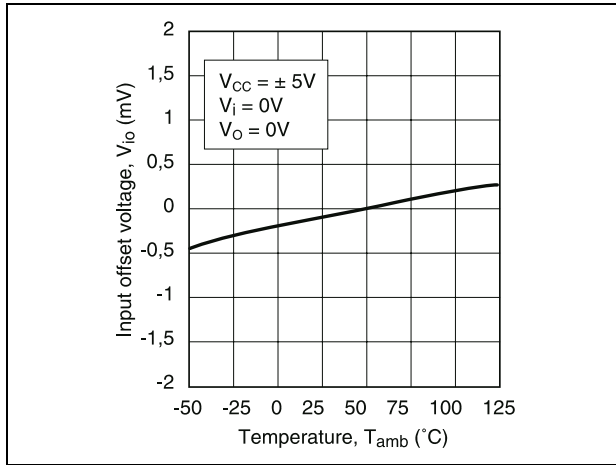

Figure 3. Static open-loop voltage gain

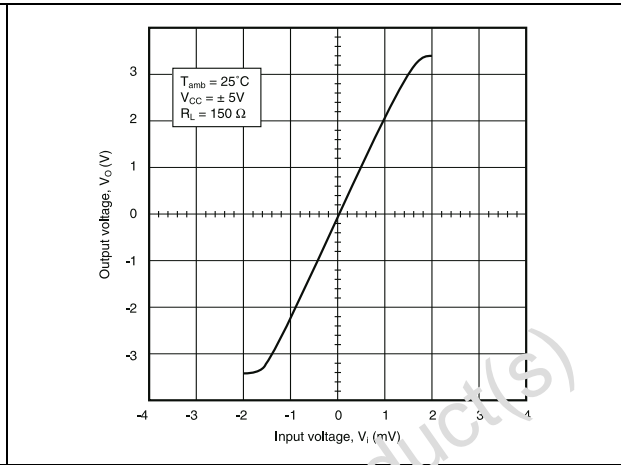

Figure 4. Large signal follower response

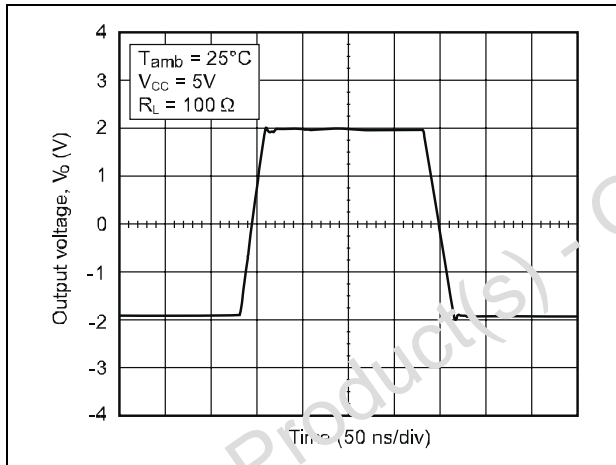

Figure 5. Small signal follower response

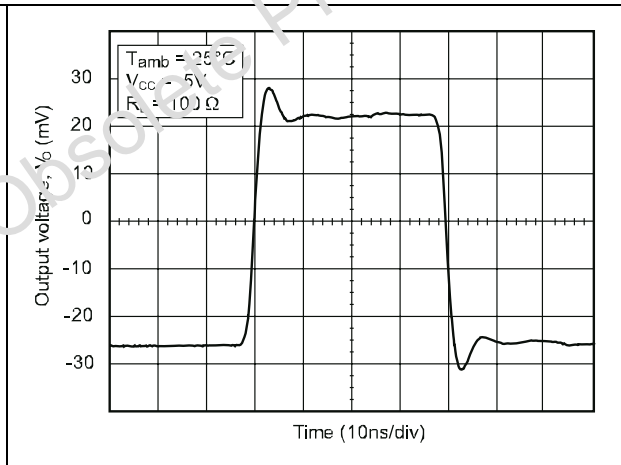

Figure 6. Open-loop frequency response & phase shift

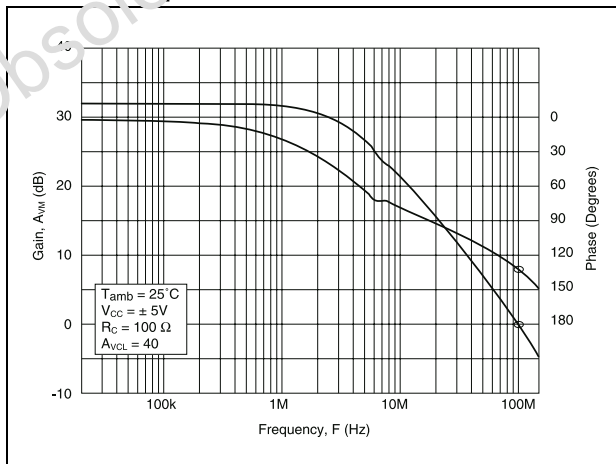

Figure 7. Closed-loop frequency response

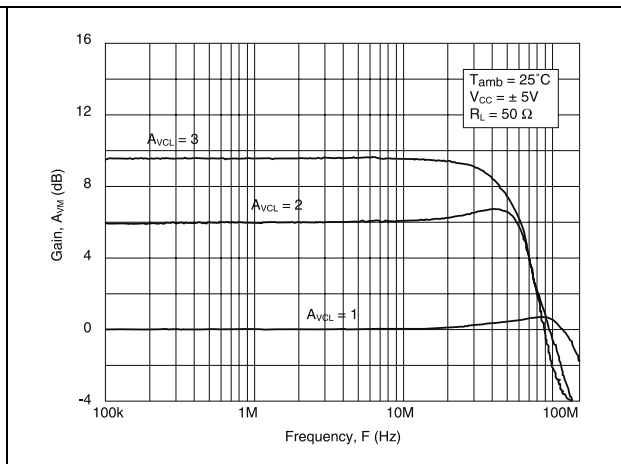

Figure 8. Audio bandwidth frequency - Response & phase shift (TSH93 vs. standard 15 MHz audio op-amp)

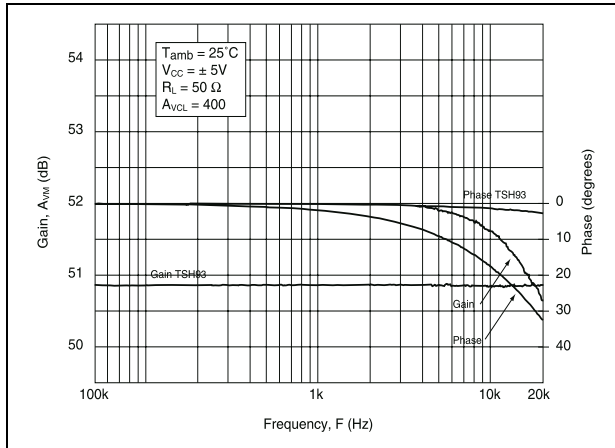

Figure 9. Gain flatness & phase shift vs. frequency

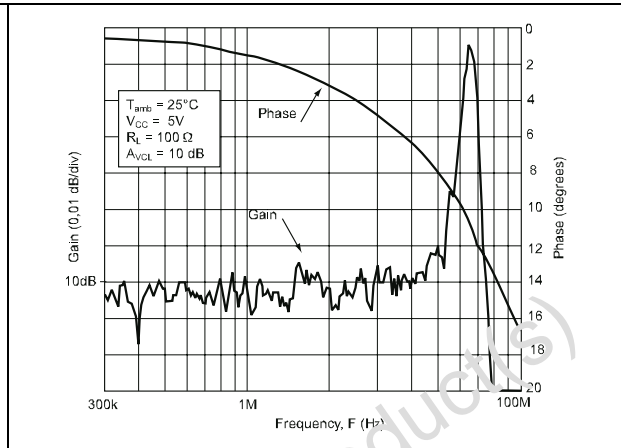

Figure 10. Cross talk isolation vs. frequency (SO-14 package)

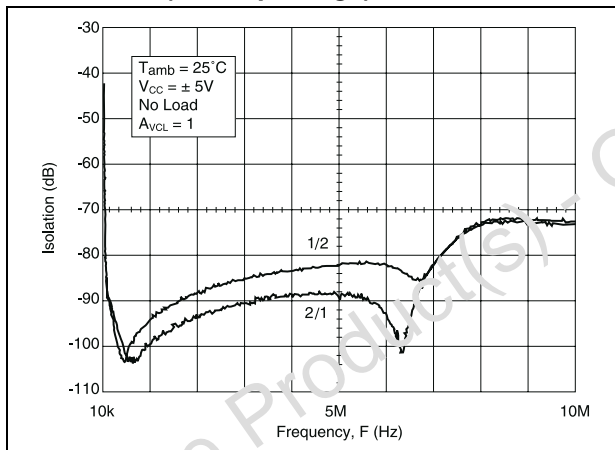

Figure 11. Cross talk isolation vs. frequency (SO-14 package)

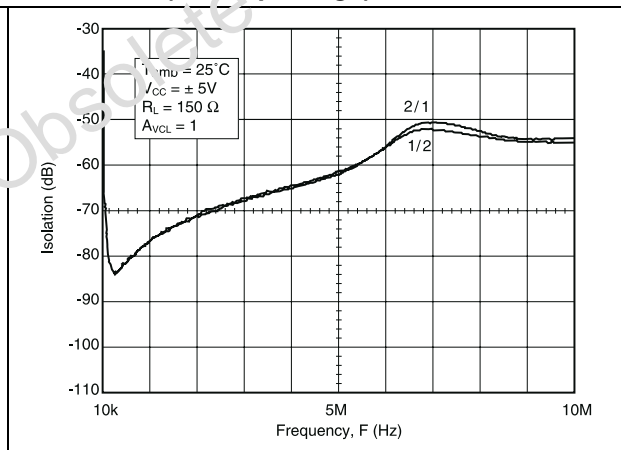

Figure 12. Differential input impedance vs. frequency

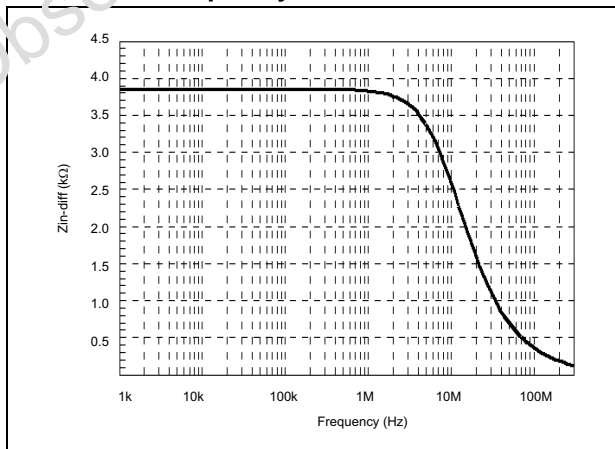
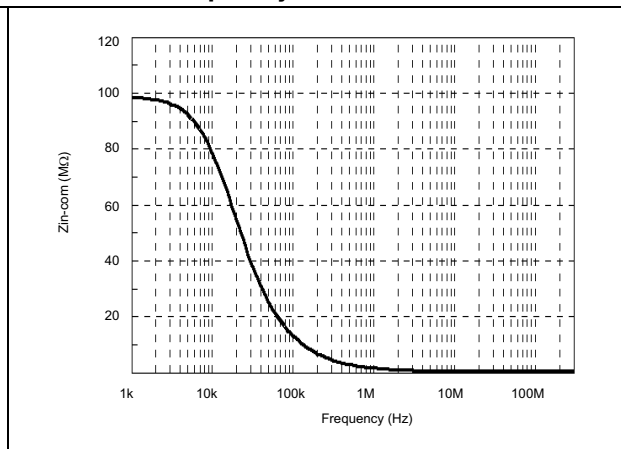

Figure 13. Common input impedance vs. frequency



4 Printed circuit layout

As for any high-frequency device, a few rules must be observed when designing the PCB to get the best performance from this high speed op-amp.

From the most important to the least important point.

- Each power supply lead must be bypassed to ground with a 10 nF ceramic capacitor very close to the device and a 10 μ F capacitor.
- To provide low inductance and low resistance common return, use a ground plane or common point return for power and signal.
- All leads must be wide and as short as possible especially for op-amp inputs. This is in order to decrease parasitic capacitance and inductance.
- Use small resistor values to decrease the time constant with parasitic capacitance.
- Choose component sizes as small as possible (SMD).

At the output, decrease the capacitor load to avoid degradation in circuit stability which may cause oscillation. You can also add a serial resistor in order to minimize its influence.

5 Macromodel

Consider the following remarks before using this macromodel.

- All models are a trade-off between accuracy and complexity (that is, simulation time).
- Macromodels are not a substitute to breadboarding; rather, they confirm the validity of a design approach and help to select surrounding component values.
- A macromodel emulates the **nominal** performance of a **typical** device within **specified operating conditions** (temperature, supply voltage, for example). Thus the macromodel is often not as exhaustive as the datasheet, its purpose is to illustrate the main parameters of the product.

Data derived from macromodels used outside of the specified conditions (V_{CC} , temperature, for example) or even worse, outside of the device operating conditions (V_{CC} , V_{in} , for example), is not reliable in any way.

This macromodel applies to: TSH93I

```

** Standard Linear Ics Macromodels, 1997.
** CONNECTIONS :
* 1 INVERTING INPUT
* 2 NON-INVERTING INPUT
* 3 OUTPUT
* 4 POSITIVEPOWER SUPPLY
* 5 NEGATIVE POWER SUPPLY
.SUBCKT TSH93 1 3 2 4 5(ana.log
*****
.MODEL MDTH D IS=1E-8 KF=1.809064E-15 CJO=10F
* INPUT STAGE
CIP 2 5 1.000000E-12
CIN 1 5 1.000000E-12
EIP 10 5 2 5 1
EIN 16 5 1 5 1
RIP 10 11 2.600000E-01
RIN 15 16 2.600000E-01
RIC 11 15 3.645298E-01
DIP 11 12 MDTH 400E-12
DIN 15 14 MDTH 400E-12
VOFP 12 13 DC 0.000000E+00
VOFN 13 14 DC 0
IPOL 13 5 1.000000E-03
CPS 11 15 2.986990E-10
DINN 17 13 MDTH 400E-12
VIN 17 5 2.000000E+00
DINR 15 18 MDTH 400E-12
VIP 4 18 1.000000E+00
FCP 4 5 VOFP 3.500000E+00
FCN 5 4 VOFN 3.500000E+00
FIBP 2 5 VOFP 1.000000E-02
FIBN 5 1 VOFN 1.000000E-02
* AMPLIFYING STAGE
FIP 5 19 VOFP 2.530000E+02
FIN 5 19 VOFN 2.530000E+02

```

```
RG1 19 5 3.160721E+03
RG2 19 4 3.160721E+03
CC 19 5 2.00000E-09
DOPM 19 22 MDTH 400E-12
DONM 21 19 MDTH 400E-12
HOPM 22 28 VOUT 1.504000E+03
VIPM 28 4 5.000000E+01
HONM 21 27 VOUT 1.400000E+03
VINM 5 27 5.000000E+01
*****
RZP1 5 80 1E+06
RZP2 4 80 1E+06
GZP 5 82 19 80 2.5E-05
RZP2H 83 4 10000
RZP1H 83 82 80000
RZP2B 84 5 10000
RZP1B 82 84 80000
LZPH 4 83 3.535e-02
LZPB 84 5 3.535e-02
EOUT 26 23 82 5 1
VOUT 23 5 0
ROUT 26 3 35
COUT 3 5 30.000000E-12
DOP 19 25 MDTH 400E-12
VOP 4 25 2.361965E+00
DON 24 19 MDTH 400E-12
VON 24 5 2.361965E+00
.ENDS
```

Obsolete Product(s) - Obsolete Product(s)



6 Package information

In order to meet environmental requirements, ST offers these devices in different grades of ECOPACK® packages, depending on their level of environmental compliance. ECOPACK® specifications, grade definitions and product status are available at: www.st.com. ECOPACK® is an ST trademark.

Obsolete Product(s) - Obsolete Product(s)

6.1 SO-14 package information

Figure 14. SO-14 package mechanical drawing

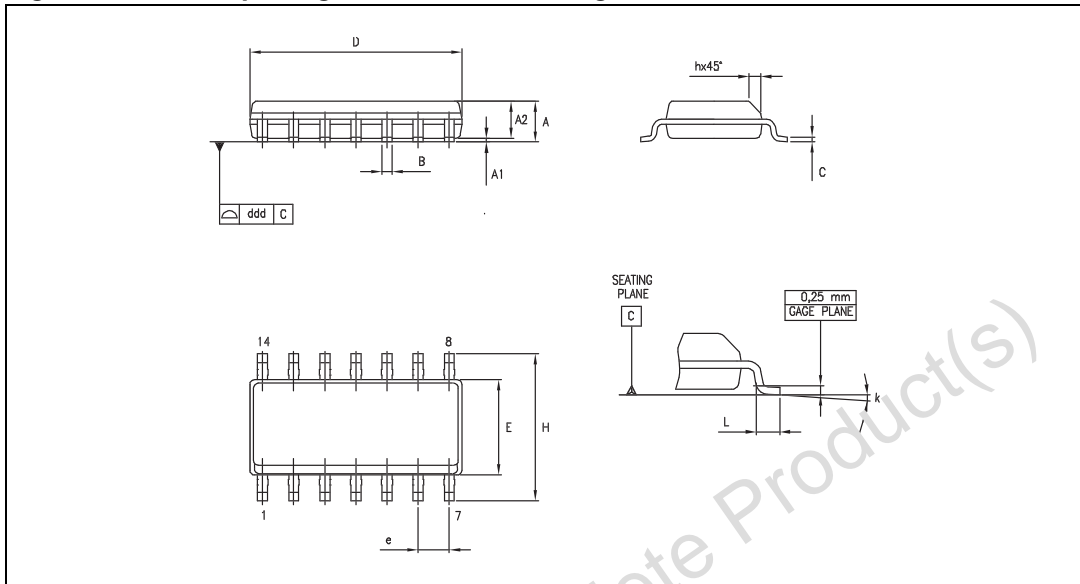

Table 5. SO-14 package mechanical data

Ref.	Dimensions					
	Millimeters			Inches		
	Min.	Typ.	Max.	Min.	Typ.	Max.
A	1.35		1.75	0.05		0.068
A1	0.10		0.25	0.004		0.009
A2	1.10		1.65	0.04		0.06
B	0.33		0.51	0.01		0.02
C	0.19		0.25	0.007		0.009
D	8.55		8.75	0.33		0.34
E	3.80		4.0	0.15		0.15
e		1.27			0.05	
H	5.80		6.20	0.22		0.24
h	0.25		0.50	0.009		0.02
L	0.40		1.27	0.015		0.05
k	8° (max.)					
ddd			0.10			0.004

7 Ordering information

Table 6. Order codes

Order code	Temperature range	Package	Packaging	Marking
TSH93ID TSH93IDT	-40° C, +125° C	SO-14	Tube or Tape & reel	H93

Obsolete Product(s) - Obsolete Product(s)

8 Revision history

Table 7. Document revision history

Date	Revision	Changes
31-Oct-2000	1	First release.
01-Aug- 2005	3	PPAP references inserted in the datasheet see Order Codes table on page 1.
24-Oct-2007	3	Added ESD parameters in Table 1: Absolute maximum ratings (AMR) . PPAP footnote inserted in the datasheet see Table 6: Order codes on page 13 .
11-May-2009	4	Removed TSH93IYD-IYDT from Table 6: Order codes . Updated SO-14 package information in Chapter 6 .

Please Read Carefully:

Information in this document is provided solely in connection with ST products. STMicroelectronics NV and its subsidiaries ("ST") reserve the right to make changes, corrections, modifications or improvements, to this document, and the products and services described herein at any time, without notice.

All ST products are sold pursuant to ST's terms and conditions of sale.

Purchasers are solely responsible for the choice, selection and use of the ST products and services described herein, and ST assumes no liability whatsoever relating to the choice, selection or use of the ST products and services described herein.

No license, express or implied, by estoppel or otherwise, to any intellectual property rights is granted under this document. If any part of this document refers to any third party products or services it shall not be deemed a license grant by ST for the use of such third party products or services, or any intellectual property contained therein or considered as a warranty covering the use in any manner whatsoever of such third party products or services or any intellectual property contained therein.

UNLESS OTHERWISE SET FORTH IN ST'S TERMS AND CONDITIONS OF SALE ST DISCLAIMS ANY EXPRESS OR IMPLIED WARRANTY WITH RESPECT TO THE USE AND/OR SALE OF ST PRODUCTS INCLUDING WITHOUT LIMITATION IMPLIED WARRANTIES OF MERCHANTABILITY, FITNESS FOR A PARTICULAR PURPOSE (AND THEIR EQUIVALENTS UNDER THE LAWS OF ANY JURISDICTION), OR INFRINGEMENT OF ANY PATENT, COPYRIGHT OR OTHER INTELLECTUAL PROPERTY RIGHT.

UNLESS EXPRESSLY APPROVED IN WRITING BY AN AUTHORIZED ST REPRESENTATIVE, ST PRODUCTS ARE NOT RECOMMENDED, AUTHORIZED OR WARRANTED FOR USE IN MILITARY, AIR CRAFT, SPACE, LIFE SAVING, OR LIFE SUSTAINING APPLICATIONS, NOR IN PRODUCTS OR SYSTEMS WHERE FAILURE OR MALFUNCTION MAY RESULT IN PERSONAL INJURY, DEATH, OR SEVERE PROPERTY OR ENVIRONMENTAL DAMAGE. ST PRODUCTS WHICH ARE NOT SPECIFIED AS "AUTOMOTIVE GRADE" MAY ONLY BE USED IN AUTOMOTIVE APPLICATIONS AT USER'S OWN RISK.

Resale of ST products with provisions different from the statements and/or technical features set forth in this document shall immediately void any warranty granted by ST for the ST product or service described herein and shall not create or extend in any manner whatsoever, any liability of ST.

ST and the ST logo are trademarks or registered trademarks of ST in various countries.

Information in this document supersedes and replaces all information previously supplied.

The ST logo is a registered trademark of STMicroelectronics. All other names are the property of their respective owners.

© 2009 STMicroelectronics - All rights reserved

STMicroelectronics group of companies

Australia - Belgium - Brazil - Canada - China - Czech Republic - Finland - France - Germany - Hong Kong - India - Israel - Italy - Japan - Malaysia - Malta - Morocco - Philippines - Singapore - Spain - Sweden - Switzerland - United Kingdom - United States of America

www.st.com

