

ON Semiconductor

Is Now

onsemi™

To learn more about onsemi™, please visit our website at
www.onsemi.com

onsemi and **onsemi** and other names, marks, and brands are registered and/or common law trademarks of Semiconductor Components Industries, LLC dba "**onsemi**" or its affiliates and/or subsidiaries in the United States and/or other countries. **onsemi** owns the rights to a number of patents, trademarks, copyrights, trade secrets, and other intellectual property. A listing of **onsemi** product/patent coverage may be accessed at www.onsemi.com/site/pdf/Patent-Marking.pdf. **onsemi** reserves the right to make changes at any time to any products or information herein, without notice. The information herein is provided "as-is" and **onsemi** makes no warranty, representation or guarantee regarding the accuracy of the information, product features, availability, functionality, or suitability of its products for any particular purpose, nor does **onsemi** assume any liability arising out of the application or use of any product or circuit, and specifically disclaims any and all liability, including without limitation special, consequential or incidental damages. Buyer is responsible for its products and applications using **onsemi** products, including compliance with all laws, regulations and safety requirements or standards, regardless of any support or applications information provided by **onsemi**. "Typical" parameters which may be provided in **onsemi** data sheets and/or specifications can and do vary in different applications and actual performance may vary over time. All operating parameters, including "Typicals" must be validated for each customer application by customer's technical experts. **onsemi** does not convey any license under any of its intellectual property rights nor the rights of others. **onsemi** products are not designed, intended, or authorized for use as a critical component in life support systems or any FDA Class 3 medical devices or medical devices with a same or similar classification in a foreign jurisdiction or any devices intended for implantation in the human body. Should Buyer purchase or use **onsemi** products for any such unintended or unauthorized application, Buyer shall indemnify and hold **onsemi** and its officers, employees, subsidiaries, affiliates, and distributors harmless against all claims, costs, damages, and expenses, and reasonable attorney fees arising out of, directly or indirectly, any claim of personal injury or death associated with such unintended or unauthorized use, even if such claim alleges that **onsemi** was negligent regarding the design or manufacture of the part. **onsemi** is an Equal Opportunity/Affirmative Action Employer. This literature is subject to all applicable copyright laws and is not for resale in any manner. Other names and brands may be claimed as the property of others.

NCP4682, NCP4685

150 mA, Ultra Low Supply Current, Low Dropout Regulator

The NCP4682 and NCP4685 are CMOS Low Dropout Linear voltage regulators with 150 mA output current capability. The devices have high output voltage accuracy, a 1 μ A (typ.) ultra low supply current and high ripple rejection. Current fold-back protection is integrated in the devices to protect against over current and short current conditions. A Chip Enable (NCP4682 only) function is included to save power by further lowering supply current, which is advantageous for battery powered applications. The NCP4685 is optimized for the lowest quiescent current possible in applications where the device is always on.

Features

- Operating Input Voltage Range: 1.70 V to 5.25 V
- Output Voltage Range: 1.2 V to 3.3 V (available in 0.1 V steps)
- Output Voltage Accuracy: $\pm 0.8\%$
- Excellent Output Voltage Temperature Coefficient : ± 40 ppm/ $^{\circ}$ C
- Supply Current: 1.0 μ A (excluding CE pull down current)
- Standby Current: 0.1 μ A
- Dropout Voltage: 0.24 V ($I_{OUT} = 150$ mA, $V_{OUT} = 2.8$ V)
- Line Regulation: 0.02%/V Typ.
- Stable with Ceramic Capacitors: 0.1 μ F or more
- Current Fold Back Protection
- Available in UDFN4 1.0 x 1.0 mm, SC-82AB, SOT23 Packages
- These are Pb-Free Devices

Typical Applications

- Battery-Powered Equipment
- Networking and Communication Equipment
- Cameras, DVRs, STB and Camcorders
- Home Appliances

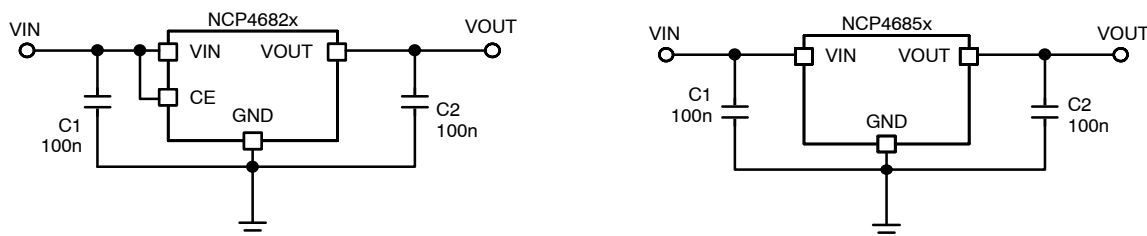

Figure 1. Typical Application Schematics



ON Semiconductor™

<http://onsemi.com>

MARKING DIAGRAMS

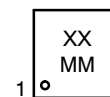
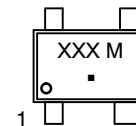
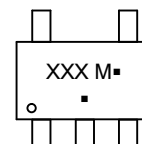

XXX, XX = Specific Device Code
M, MM = Date Code
▪ = Pb-Free Package

(*Note: Microdot may be in either location)

ORDERING INFORMATION

See detailed ordering, marking and shipping information in the package dimensions section on page 19 of this data sheet.

NCP4682, NCP4685

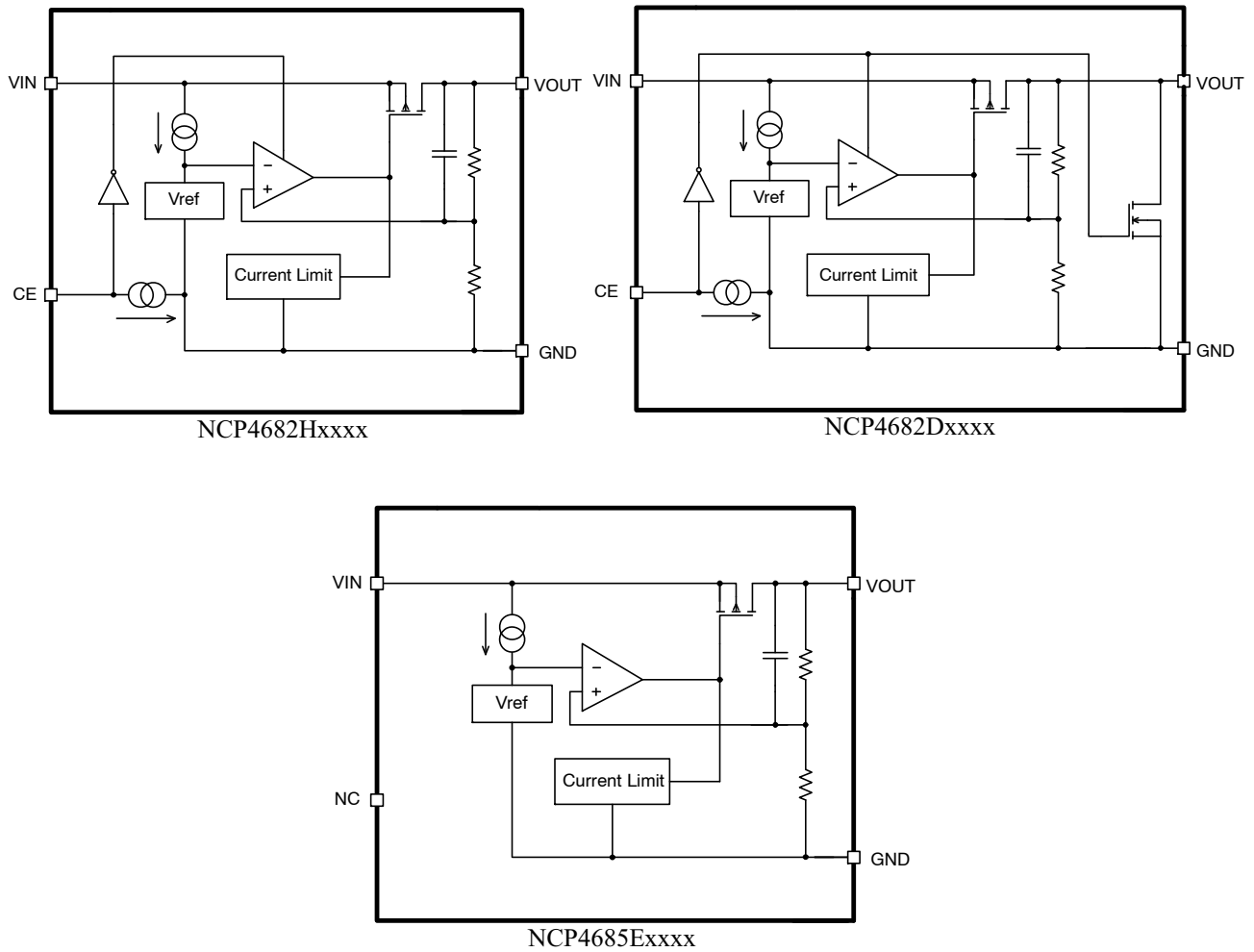

Figure 2. Simplified Schematic Block Diagram

PIN FUNCTION DESCRIPTION

Pin No. UDFN1010*	Pin No. SC-82AB	Pin No. SOT23	Pin Name	Description
1	3	5	V _{OUT}	Output pin
2	2	2	GND	Ground
3	1	3	CE/NC	Chip enable pin (Active "H") / No connection
4	4	1	V _{IN}	Input pin
-	-	4	NC	No connection

*Tab is GND level. (They are connected to the reverse side of this IC.)
The tab is better to be connected to the GND, but leaving it open is also acceptable.

ABSOLUTE MAXIMUM RATINGS

Rating	Symbol	Value	Unit
Input Voltage (Note 1)	V _{IN}	6.0	V
Output Voltage	V _{OUT}	-0.3 to V _{IN} + 0.3	V
Chip Enable Input	V _{CE}	6.0	V
Output Current	I _{OUT}	200	mA

NCP4682, NCP4685

ABSOLUTE MAXIMUM RATINGS

Rating	Symbol	Value	Unit
Power Dissipation UDFN1010	P _D	400	mW
Power Dissipation SC-82AB		380	
Power Dissipation SOT23		420	
Junction Temperature	T _J	-40 to 150	°C
Storage Temperature	T _{STG}	-55 to 125	°C
ESD Capability, Human Body Model (Note 2)	ESD _{HBM}	2000	V
ESD Capability, Machine Model (Note 2)	ESD _{MM}	200	V

Stresses exceeding Maximum Ratings may damage the device. Maximum Ratings are stress ratings only. Functional operation above the Recommended Operating Conditions is not implied. Extended exposure to stresses above the Recommended Operating Conditions may affect device reliability.

- Refer to ELECTRICAL CHARACTERISTICS and APPLICATION INFORMATION for Safe Operating Area.
- This device series incorporates ESD protection and is tested by the following methods:
 ESD Human Body Model tested per AEC-Q100-002 (EIA/JESD22-A114)
 ESD Machine Model tested per AEC-Q100-003 (EIA/JESD22-A115)
 Latchup Current Maximum Rating tested per JEDEC standard: JESD78.

THERMAL CHARACTERISTICS

Rating	Symbol	Value	Unit
Thermal Characteristics, UDFN 1.0 x 1.0 mm Thermal Resistance, Junction-to-Air	R _{θJA}	250	°C/W
Thermal Characteristics, SOT23 Thermal Resistance, Junction-to-Air	R _{θJA}	238	°C/W
Thermal Characteristics, SC-82AB Thermal Resistance, Junction-to-Air	R _{θJA}	263	°C/W

ELECTRICAL CHARACTERISTICS

-40°C ≤ T_A ≤ 85°C; V_{IN} = V_{OUT(NOM)} + 1 V or 2.5 V, whichever is greater; I_{OUT} = 1 mA, C_{IN} = C_{OUT} = 0.1 μF, unless otherwise noted.
 Typical values are at T_A = +25°C.

Parameter	Test Conditions	Symbol	Min	Typ	Max	Unit	
Operating Input Voltage	(Note 3)	V _{IN}	1.70		5.25	V	
Output Voltage	T _A = +25 °C	V _{OUT} ≥ 2.0 V	x0.992		x1.008	V	
							V _{OUT} < 2.0 V
	-40°C ≤ T _A ≤ 85°C	V _{OUT} ≥ 2.0 V	x0.985		x1.015	V	
							V _{OUT} < 2.0 V
Output Voltage Temp. Coefficient	-40°C ≤ T _A ≤ 85°C	ΔV _{OUT} / ΔT _A		±40		ppm/°C	
Line Regulation	V _{OUT(NOM)} + 0.5 V ≤ V _{IN} ≤ 5.0 V	Line _{Reg}		0.02	0.10	%/V	
Load Regulation	I _{OUT} = 1 mA to 150 mA	Load _{Reg}		10	20	mV	
Dropout Voltage	I _{OUT} = 150 mA	1.2 V ≤ V _{OUT} < 1.5 V	V _{DO}		0.76	1.05	V
		1.5 V ≤ V _{OUT} < 1.7 V			0.53	0.80	
		1.7 V ≤ V _{OUT} < 2.0 V			0.44	0.65	
		2.0 V ≤ V _{OUT} < 2.5 V			0.34	0.50	
		2.5 V ≤ V _{OUT} < 2.8 V			0.28	0.40	
		2.8 V ≤ V _{OUT} < 3.3 V			0.24	0.32	
Output Current		I _{OUT}	150			mA	
Short Current Limit	V _{OUT} = 0 V	I _{SC}		40		mA	
Quiescent Current		I _Q		1.0	1.5	μA	

NCP4682, NCP4685

ELECTRICAL CHARACTERISTICS

$-40^{\circ}\text{C} \leq T_A \leq 85^{\circ}\text{C}$; $V_{IN} = V_{OUT(NOM)} + 1\text{ V}$ or 2.5 V , whichever is greater; $I_{OUT} = 1\text{ mA}$, $C_{IN} = C_{OUT} = 0.1\text{ }\mu\text{F}$, unless otherwise noted. Typical values are at $T_A = +25^{\circ}\text{C}$.

Parameter	Test Conditions	Symbol	Min	Typ	Max	Unit
Standby Current	$V_{CE} = 0\text{ V}$, $T_A = 25^{\circ}\text{C}$, NCP4682 only	I_{STB}		0.1	1.0	μA
CE Pin Threshold Voltage (NCP4682 only)	CE Input Voltage "H"	V_{CEH}	1.5			V
	CE Input Voltage "L"	V_{CEL}			0.3	
CE Pull Down Current	NCP4682 only	I_{CEPD}		0.3		μA
Power Supply Rejection Ratio	$V_{IN} = 2.2\text{ V}$, $V_{OUT} = 1.2\text{ V}$, $\Delta V_{IN} = 0.2\text{ V}_{pk-pk}$, $I_{OUT} = 30\text{ mA}$, $f = 1\text{ kHz}$	PSRR		30		dB
Output Noise Voltage	$f = 10\text{ Hz}$ to 100 kHz , $I_{OUT} = 30\text{ mA}$, $V_{OUT} = 1.2\text{ V}$, $V_{IN} = 2.2\text{ V}$	V_N		70		μV_{rms}
Low Output Nch Tr. On Resistance	$V_{IN} = 4\text{ V}$, $V_{CE} = 0\text{ V}$, NCP4682D only	R_{LOW}		30		Ω

3. The maximum Input Voltage of the Electrical Characteristics is 5.25 V. In case of exceeding this specification, the IC must be operated in condition that the Input Voltage is up to 5.50 V and total operation time is within 500 hours.

TYPICAL CHARACTERISTICS

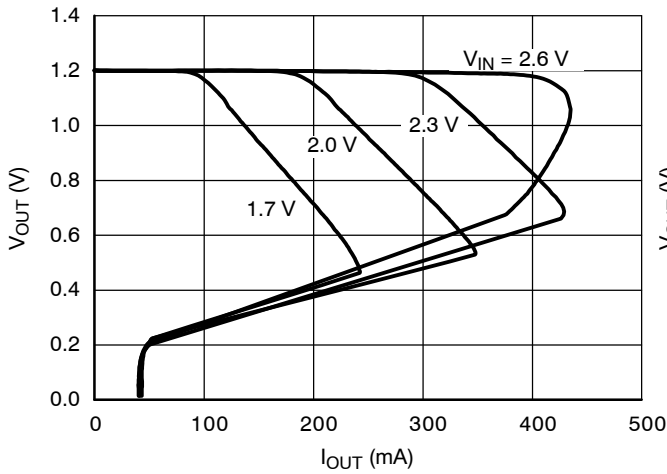

Figure 3. Output Voltage vs. Output Current
1.2 V Version ($T_J = 25^\circ\text{C}$)

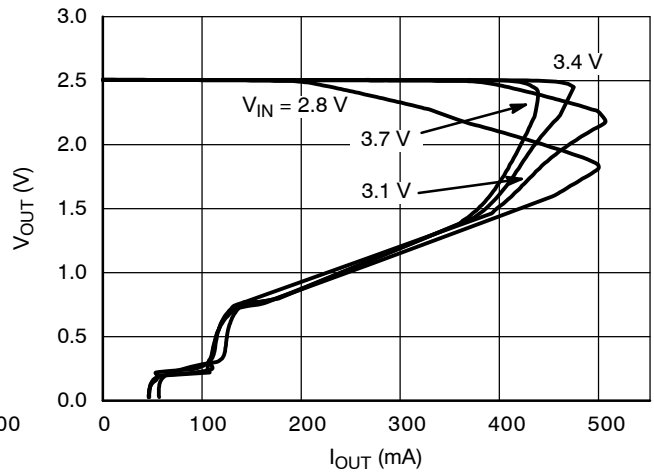

Figure 4. Output Voltage vs. Output Current
2.5 V Version ($T_J = 25^\circ\text{C}$)

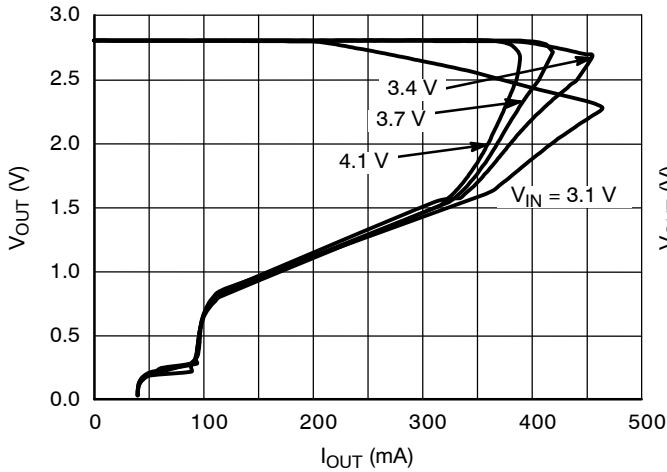

Figure 5. Output Voltage vs. Output Current
2.8 V Version ($T_J = 25^\circ\text{C}$)

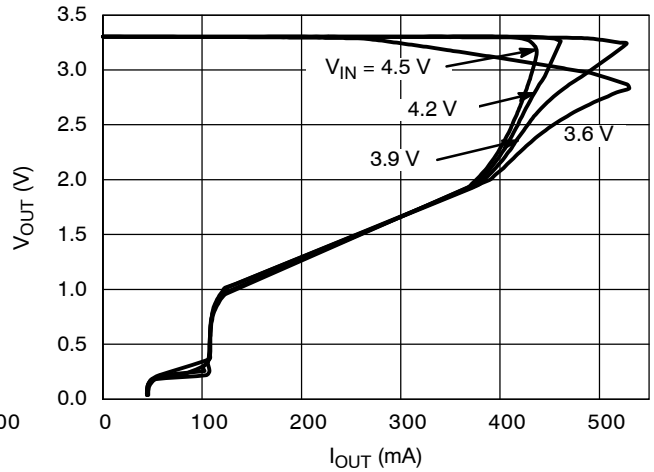

Figure 6. Output Voltage vs. Output Current
3.3 V Version ($T_J = 25^\circ\text{C}$)

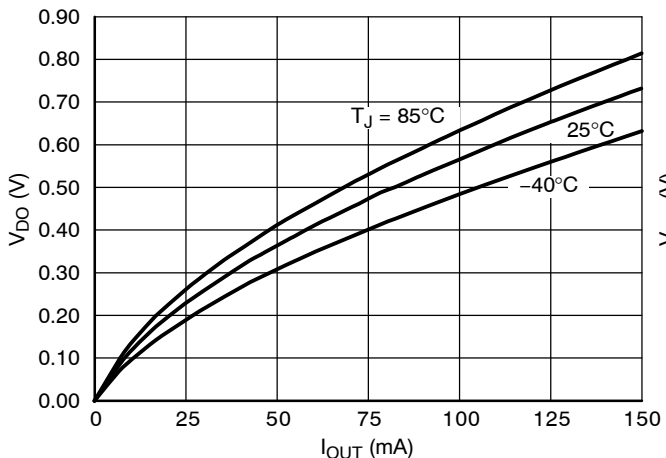

Figure 7. Dropout Voltage vs. Output Current
1.2 V Version

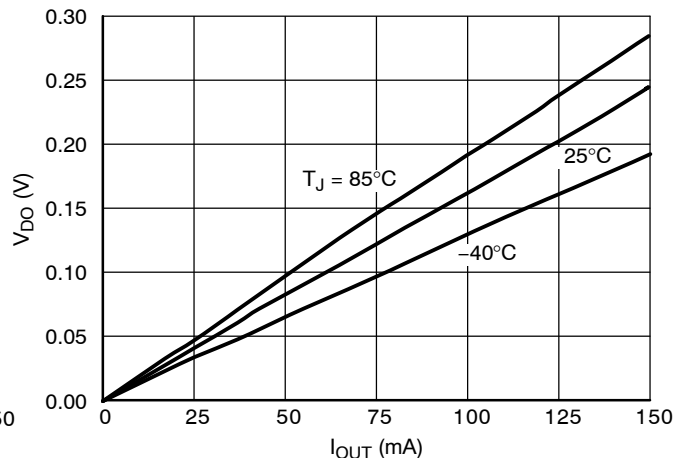
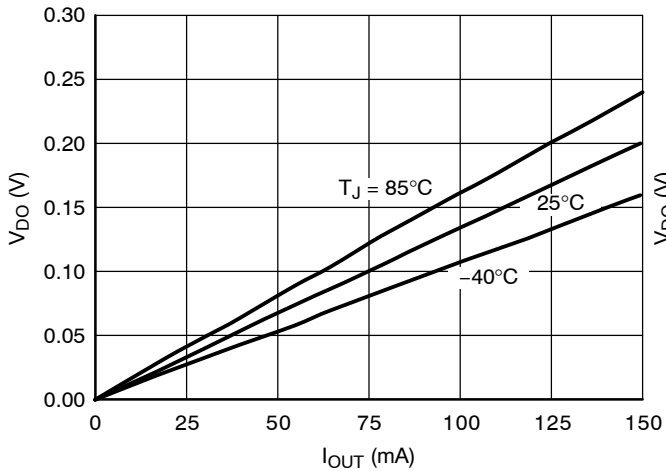

Figure 8. Dropout Voltage vs. Output Current
2.5 V Version

NCP4682, NCP4685

TYPICAL CHARACTERISTICS



**Figure 9. Dropout Voltage vs. Output Current
2.8 V Version**

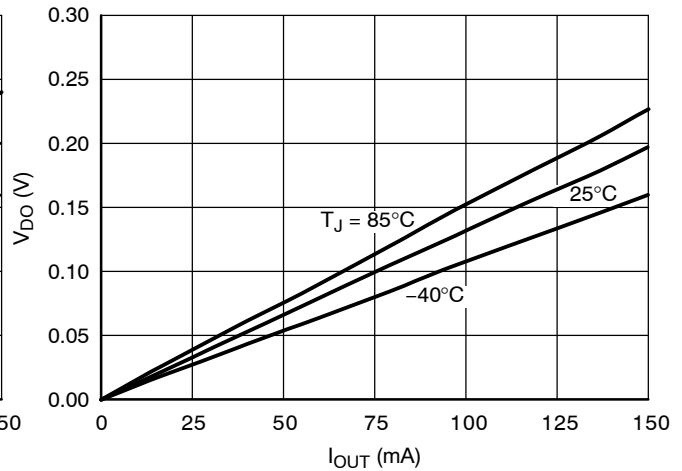

**Figure 10. Dropout Voltage vs. Output Current
3.3 V Version**

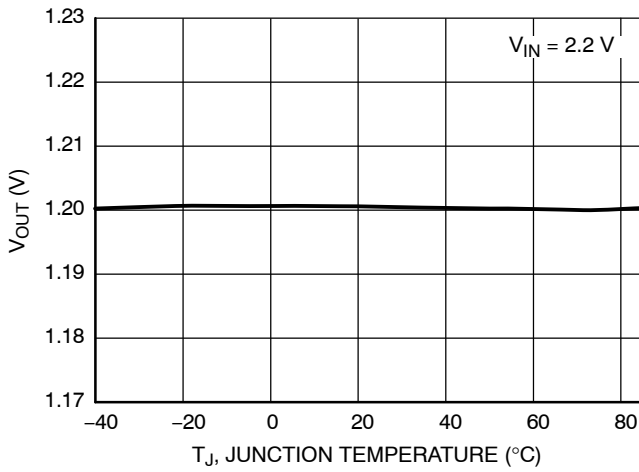

**Figure 11. Output Voltage vs. Temperature,
1.2 V Version**

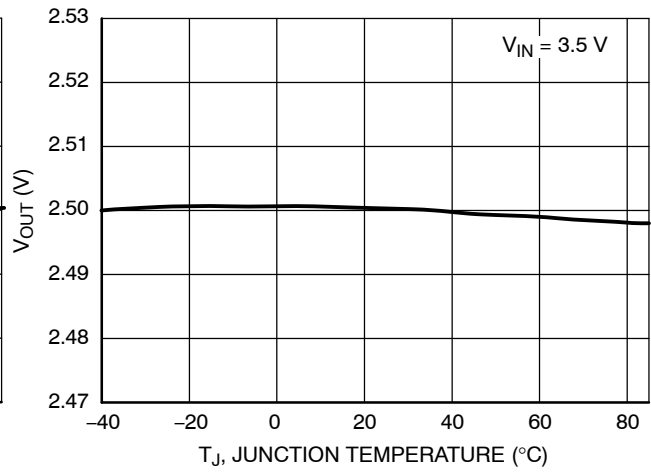

**Figure 12. Output Voltage vs. Temperature,
2.5 V Version**

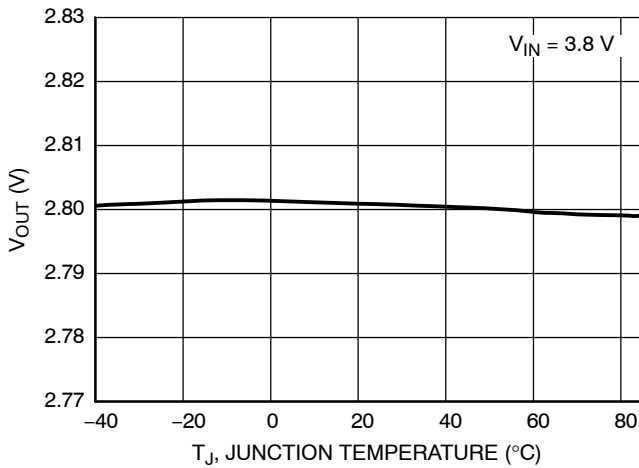

**Figure 13. Output Voltage vs. Temperature,
2.8 V Version**

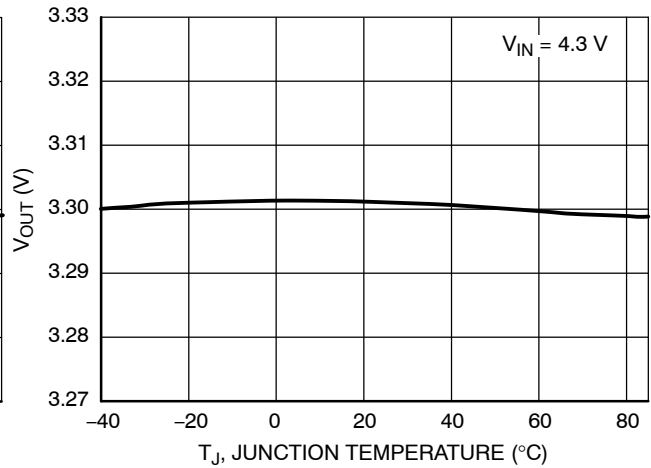

**Figure 14. Output Voltage vs. Temperature,
3.3 V Version**

NCP4682, NCP4685

TYPICAL CHARACTERISTICS

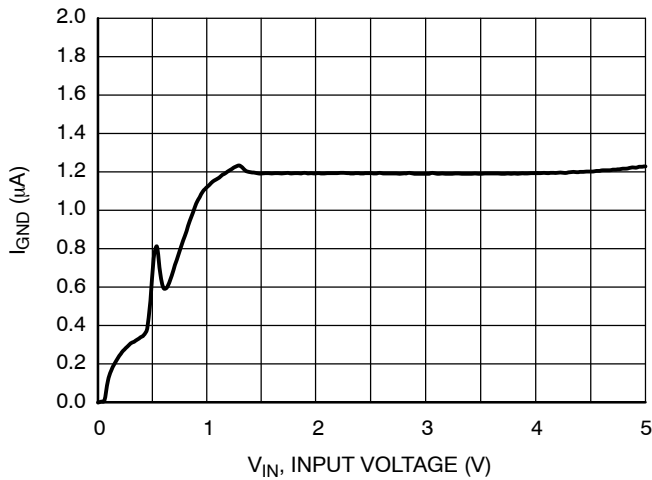

Figure 15. Supply Current vs. Input Voltage, 1.2 V Version

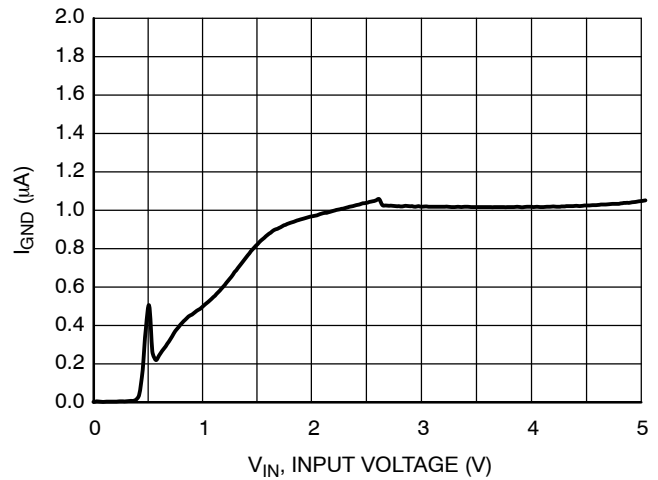

Figure 16. Supply Current vs. Input Voltage, 2.5 V Version

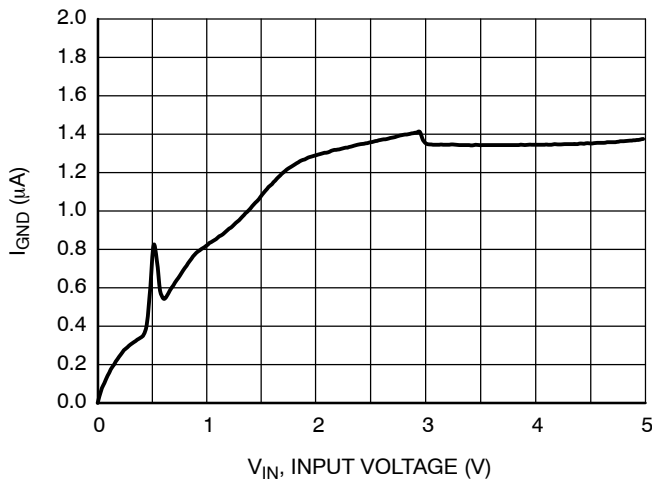

Figure 17. Supply Current vs. Input Voltage, 2.8 V Version

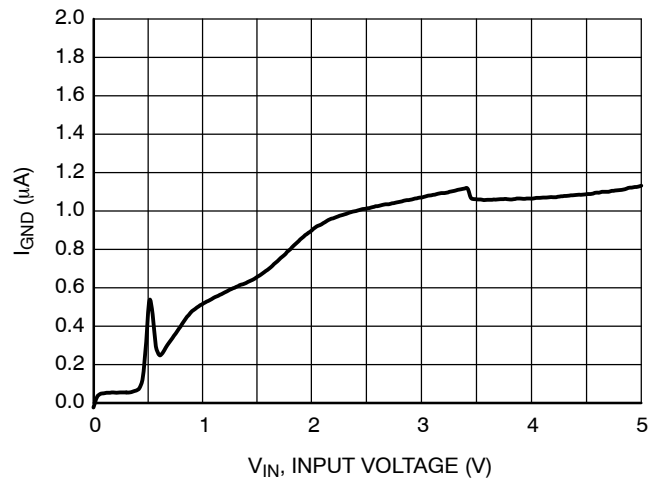

Figure 18. Supply Current vs. Input Voltage, 3.3 V Version

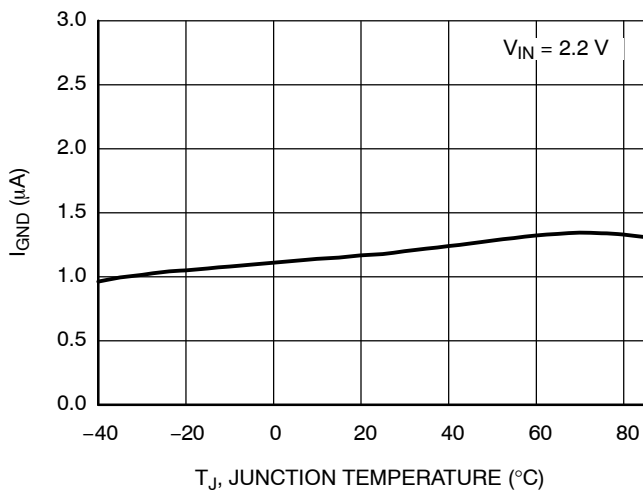

Figure 19. Supply Current vs. Temperature, 1.2 V Version

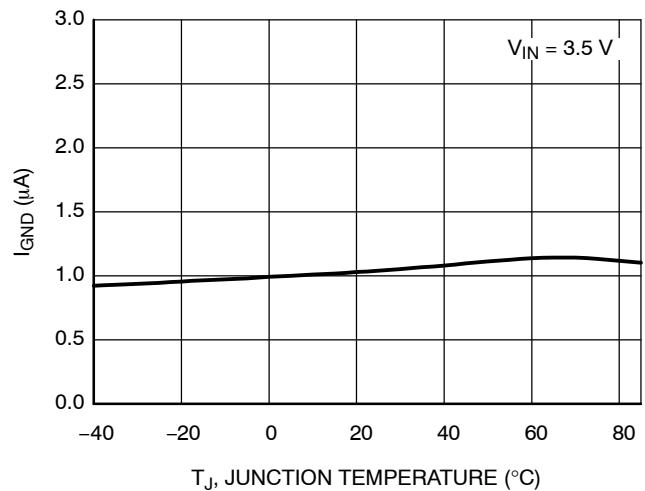

Figure 20. Supply Current vs. Temperature, 2.5 V Version

NCP4682, NCP4685

TYPICAL CHARACTERISTICS

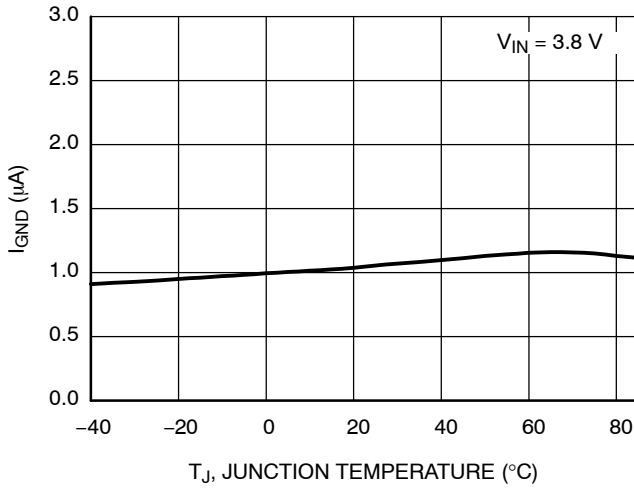

Figure 21. Supply Current vs. Temperature, 2.8 V Version

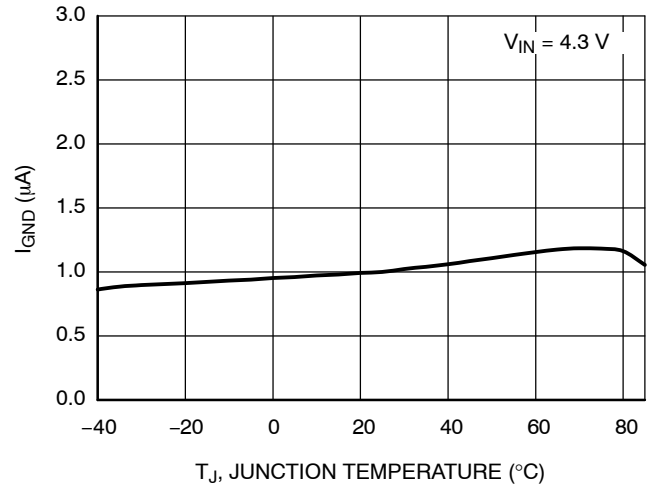

Figure 22. Supply Current vs. Temperature, 3.3 V Version

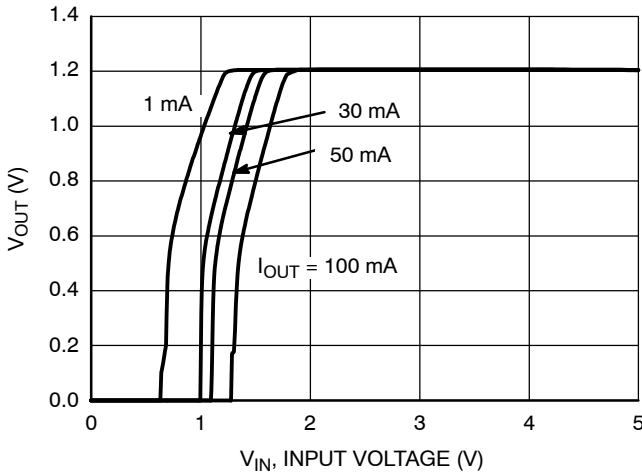

Figure 23. Output Voltage vs. Input Voltage, 1.2 V Version

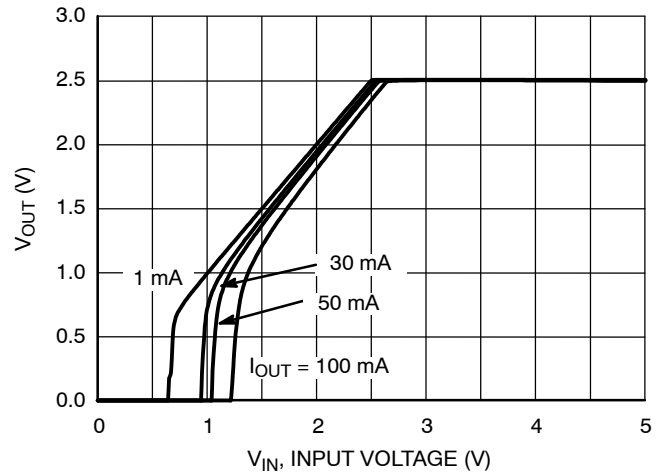

Figure 24. Output Voltage vs. Input Voltage, 2.5 V Version

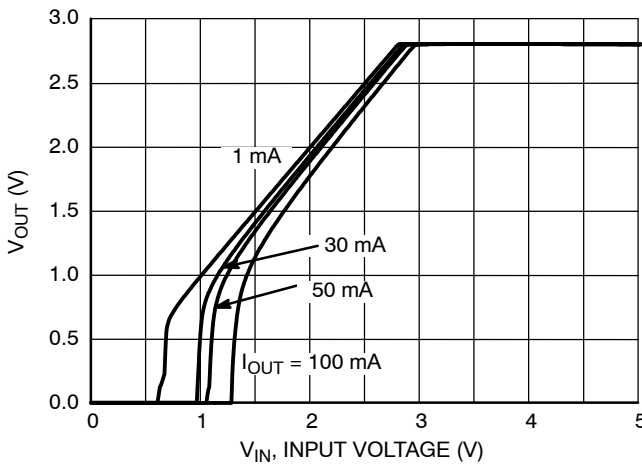

Figure 25. Output Voltage vs. Input Voltage, 2.8 V Version

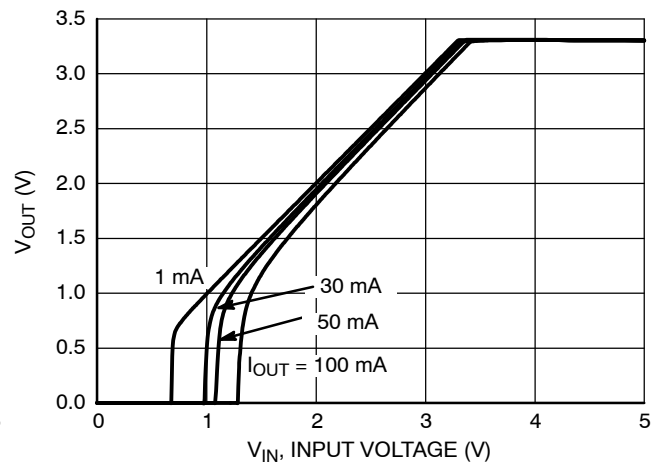

Figure 26. Output Voltage vs. Input Voltage, 3.3 V Version

TYPICAL CHARACTERISTICS

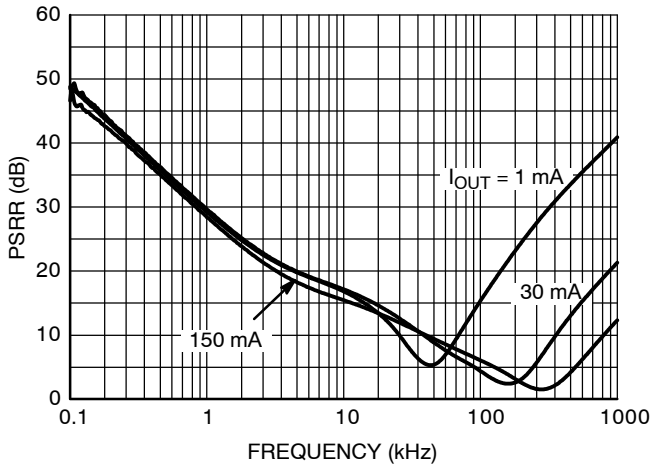

Figure 27. PSRR, 1.2 V Version, $V_{IN} = 2.2 V$

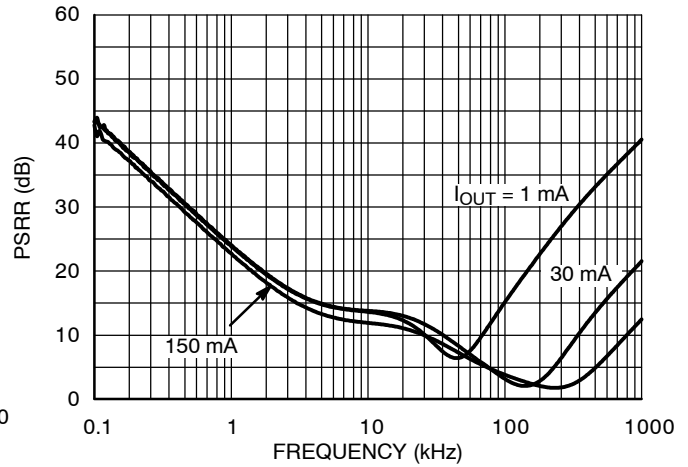

Figure 28. PSRR, 2.5 V Version, $V_{IN} = 3.5 V$

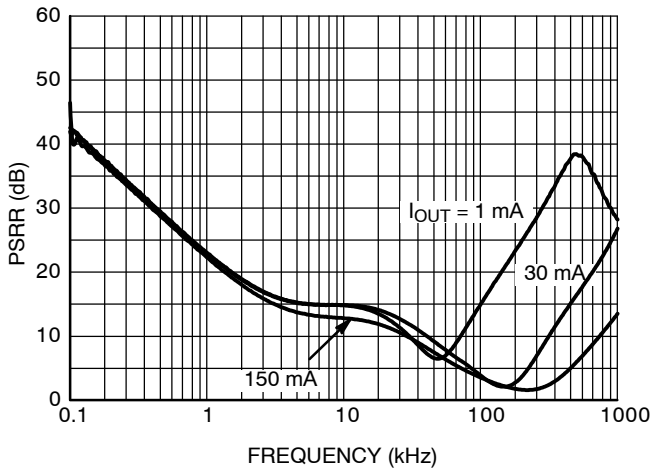

Figure 29. PSRR, 2.8 V Version, $V_{IN} = 3.8 V$

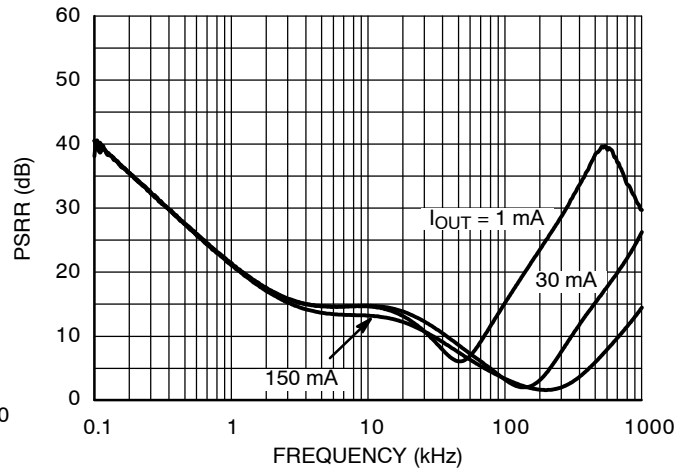

Figure 30. PSRR, 3.3 V Version, $V_{IN} = 4.3 V$

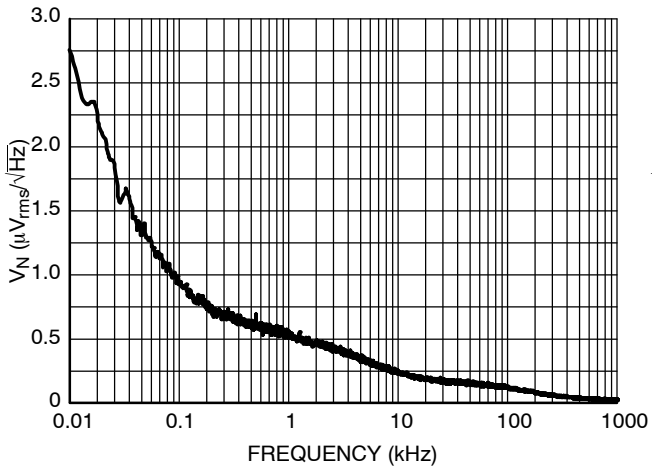

Figure 31. Output Voltage Noise, 1.2 V Version, $V_{IN} = 2.2 V, I_{OUT} = 30 mA$

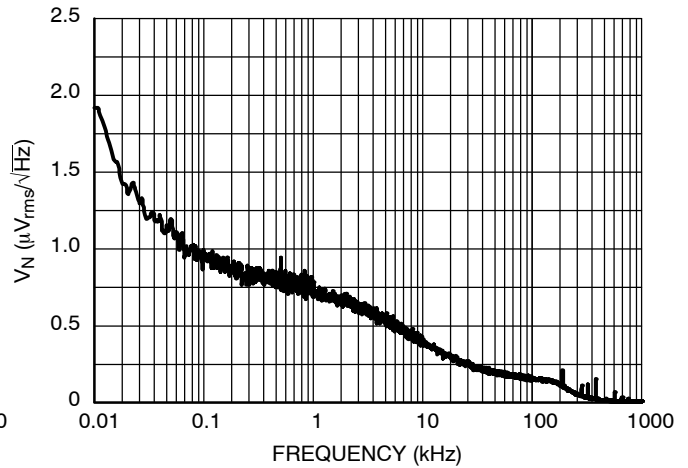

Figure 32. Output Voltage Noise, 2.5 V Version, $V_{IN} = 3.5 V, I_{OUT} = 30 mA$

NCP4682, NCP4685

TYPICAL CHARACTERISTICS

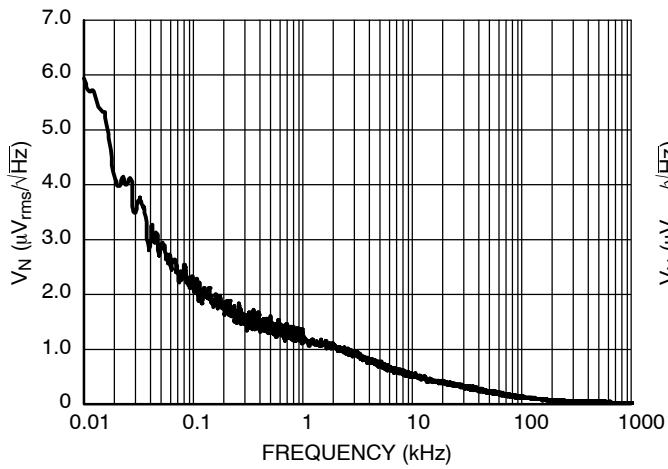

Figure 33. Output Voltage Noise, 2.8 V Version,
 $V_{IN} = 3.8 \text{ V}$, $I_{OUT} = 30 \text{ mA}$

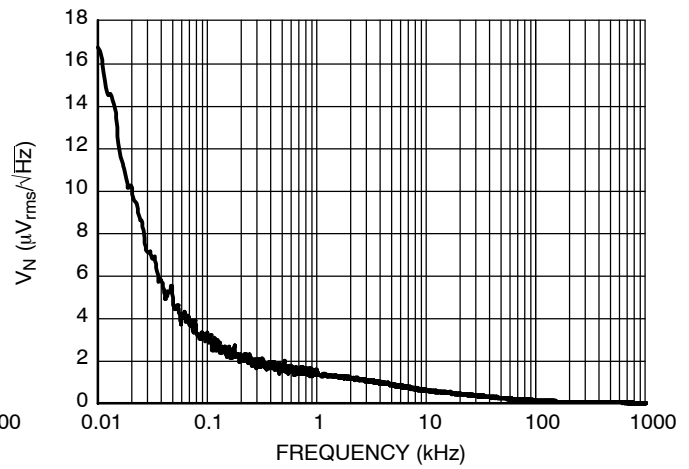

Figure 34. Output Voltage Noise, 3.3 V Version,
 $V_{IN} = 4.3 \text{ V}$, $I_{OUT} = 30 \text{ mA}$

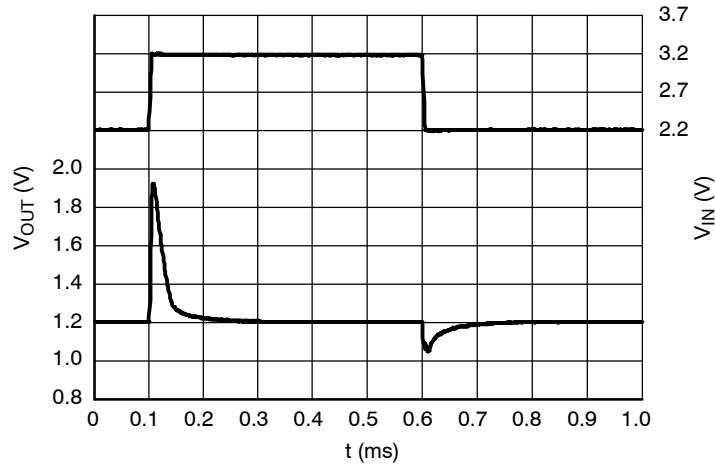

Figure 35. Line Transients, 1.2 V Version,
 $t_R = t_F = 5 \mu\text{s}$, $I_{OUT} = 30 \text{ mA}$

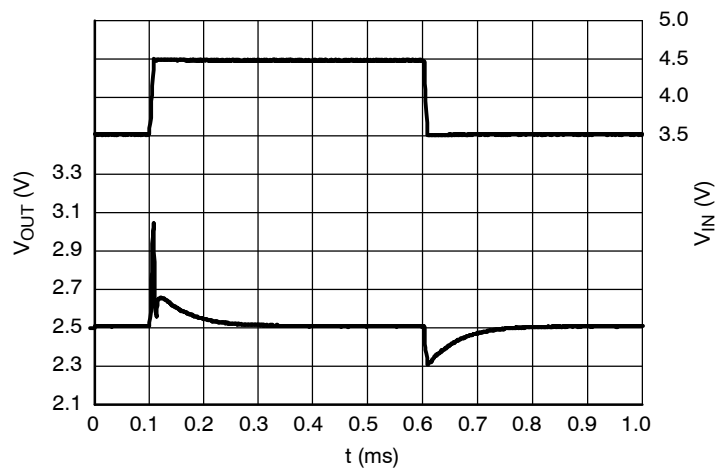

Figure 36. Line Transients, 2.5 V Version,
 $t_R = t_F = 5 \mu\text{s}$, $I_{OUT} = 30 \text{ mA}$

NCP4682, NCP4685

TYPICAL CHARACTERISTICS

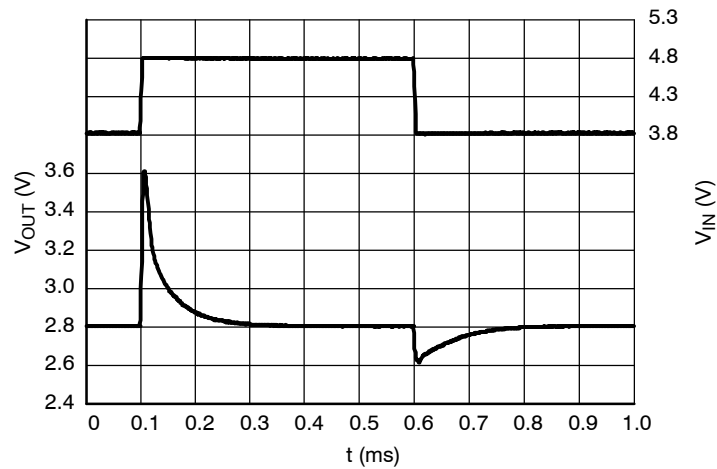

Figure 37. Line Transients, 2.8 V Version,
 $t_R = t_F = 5 \mu s$, $I_{OUT} = 30 \text{ mA}$

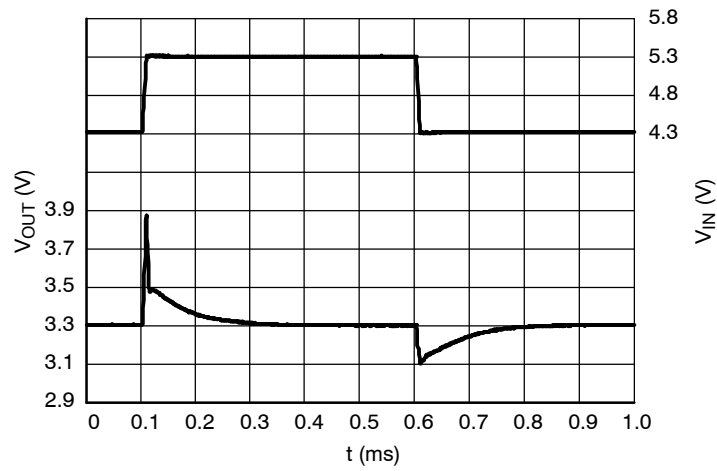

Figure 38. Line Transients, 3.3 V Version,
 $t_R = t_F = 5 \mu s$, $I_{OUT} = 30 \text{ mA}$

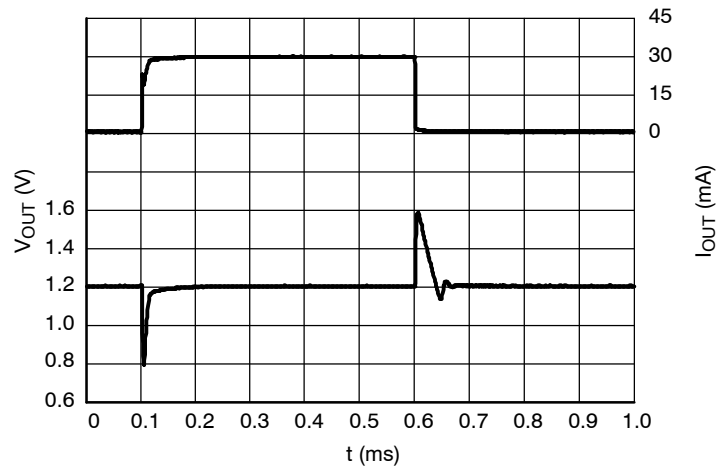
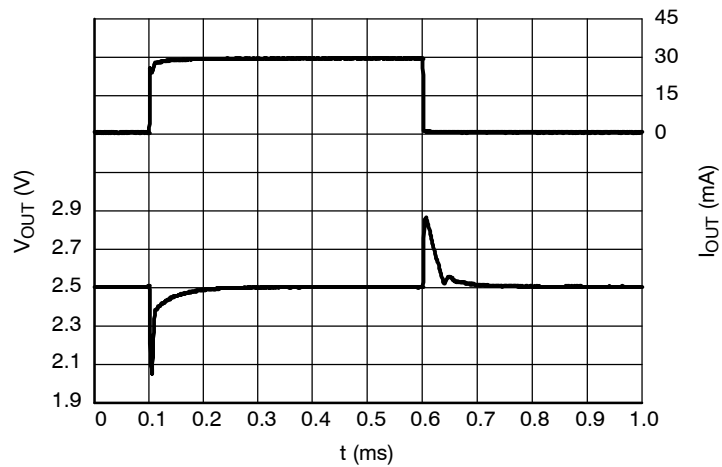

Figure 39. Load Transients, 1.2 V Version,
 $I_{OUT} = 1 - 30 \text{ mA}$, $t_R = t_F = 0.5 \mu s$, $V_{IN} = 2.2 \text{ V}$

NCP4682, NCP4685

TYPICAL CHARACTERISTICS



**Figure 40. Load Transients, 2.5 V Version,
 $I_{OUT} = 1 - 30$ mA, $t_R = t_F = 0.5$ μ s, $V_{IN} = 3.5$ V**

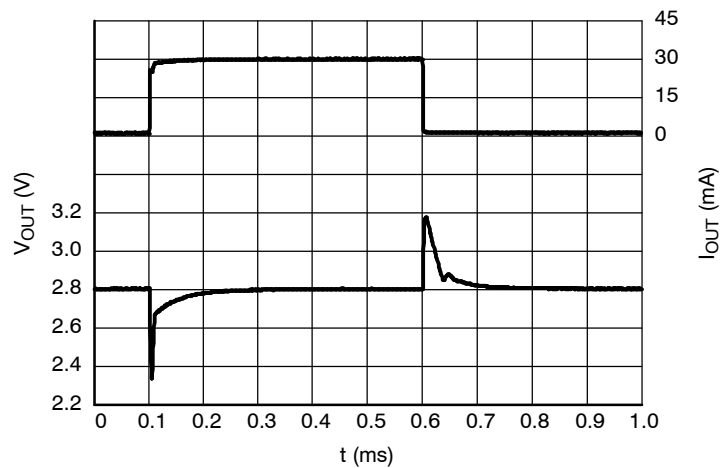

**Figure 41. Load Transients, 2.8 V Version,
 $I_{OUT} = 1 - 30$ mA, $t_R = t_F = 0.5$ μ s, $V_{IN} = 3.8$ V**

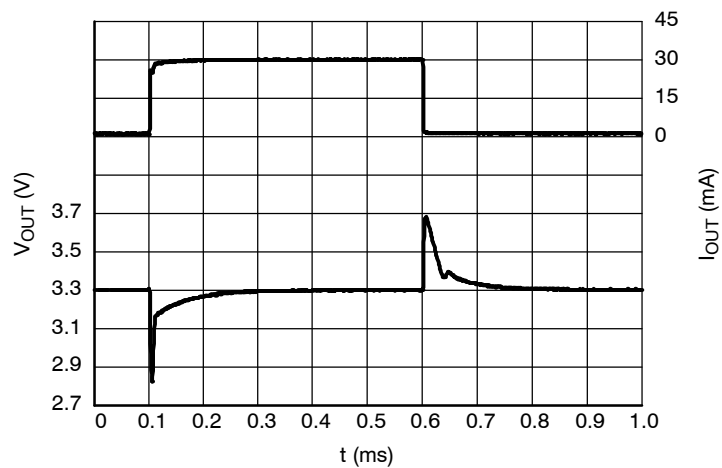

**Figure 42. Load Transients, 3.3 V Version,
 $I_{OUT} = 1 - 30$ mA, $t_R = t_F = 0.5$ μ s, $V_{IN} = 4.3$ V**

NCP4682, NCP4685

TYPICAL CHARACTERISTICS

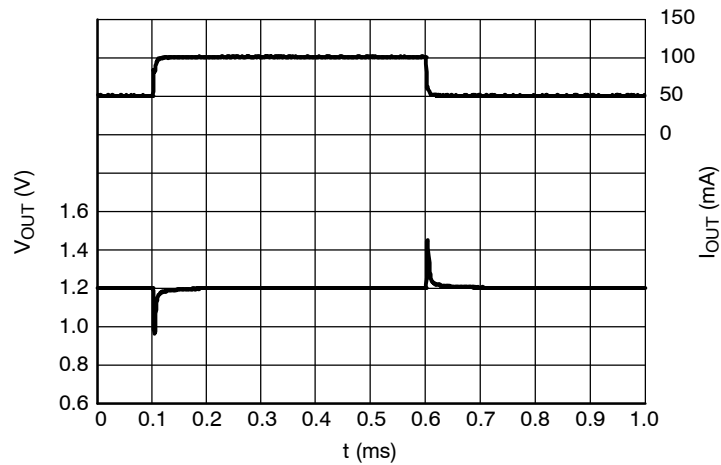

**Figure 43. Load Transients, 1.2 V Version,
 $I_{OUT} = 50 - 100$ mA, $t_R = t_F = 0.5$ μ s, $V_{IN} = 2.2$ V**

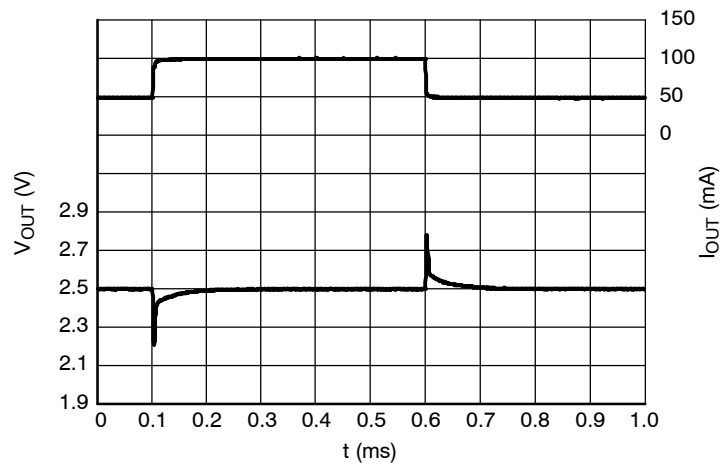

**Figure 44. Load Transients, 2.5 V Version,
 $I_{OUT} = 50 - 100$ mA, $t_R = t_F = 0.5$ μ s, $V_{IN} = 3.5$ V**

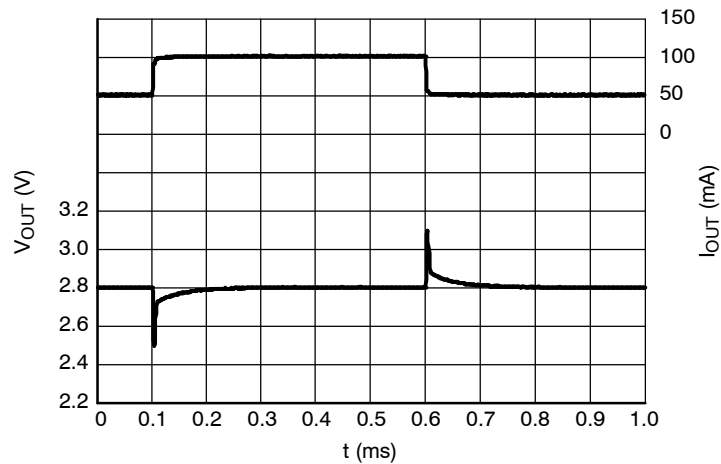

**Figure 45. Load Transients, 2.8 V Version,
 $I_{OUT} = 50 - 100$ mA, $t_R = t_F = 0.5$ μ s, $V_{IN} = 3.8$ V**

NCP4682, NCP4685

TYPICAL CHARACTERISTICS

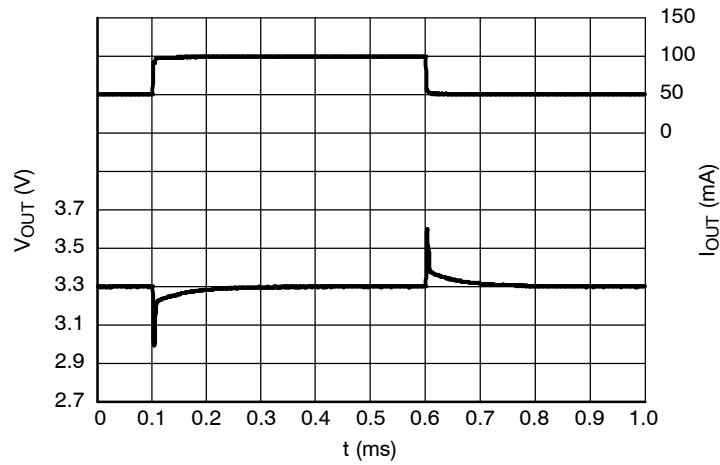

**Figure 46. Load Transients, 3.3 V Version,
I_{OUT} = 50 – 100 mA, t_R = t_F = 0.5 μs, V_{IN} = 4.3 V**

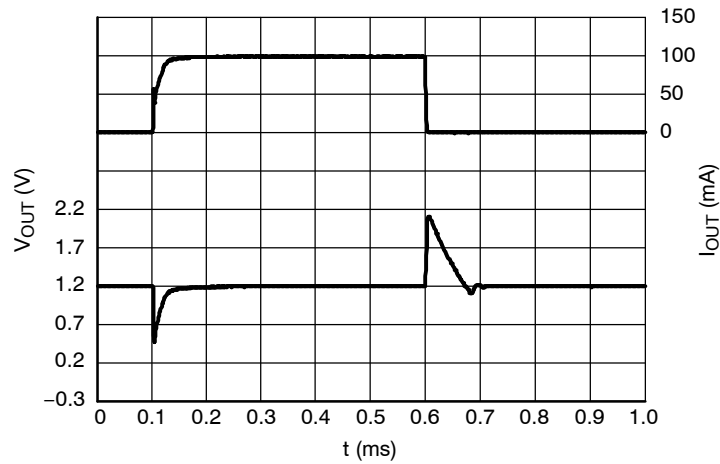

**Figure 47. Load transients, 1.2 V Version,
I_{OUT} = 1 – 100 mA, t_R = t_F = 0.5 μs, V_{IN} = 2.2 V**

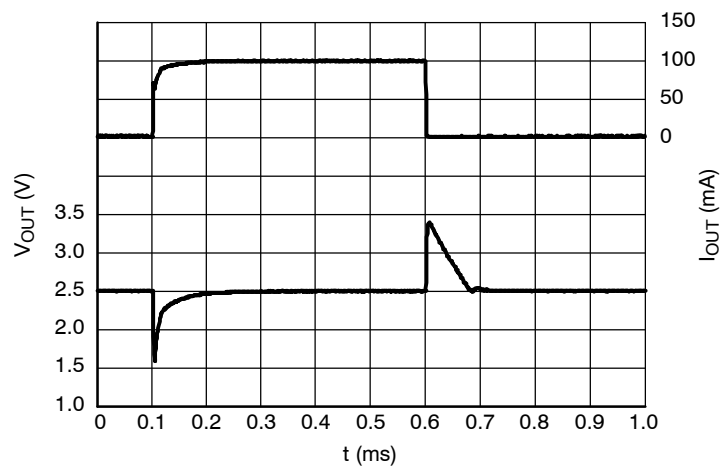

**Figure 48. Load Transients, 2.5 V Version,
I_{OUT} = 1 – 100 mA, t_R = t_F = 0.5 μs, V_{IN} = 3.5 V**

NCP4682, NCP4685

TYPICAL CHARACTERISTICS

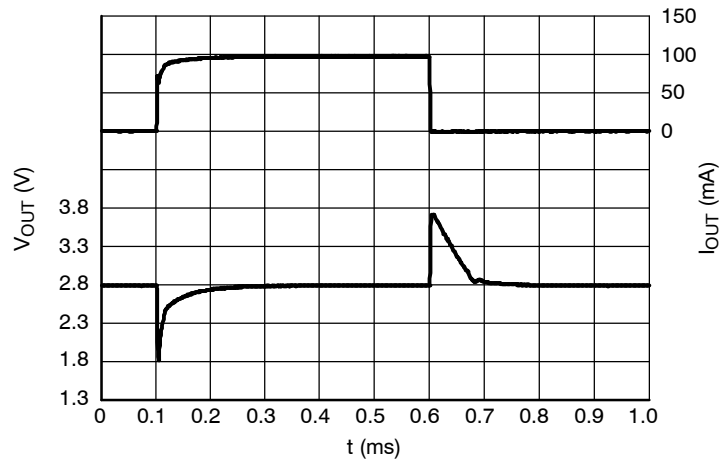

**Figure 49. Load Transients, 2.8 V Version,
 $I_{OUT} = 1 - 100$ mA, $t_R = t_F = 0.5$ μ s, $V_{IN} = 3.8$ V**

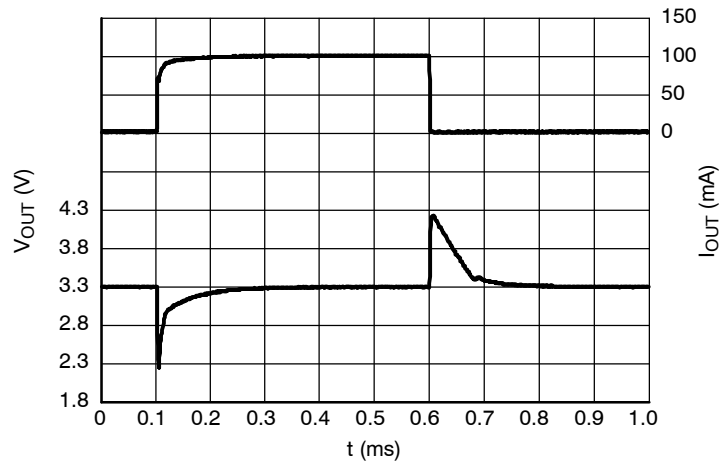

**Figure 50. Load Transients, 3.3 V Version,
 $I_{OUT} = 1 - 100$ mA, $t_R = t_F = 0.5$ μ s, $V_{IN} = 4.3$ V**

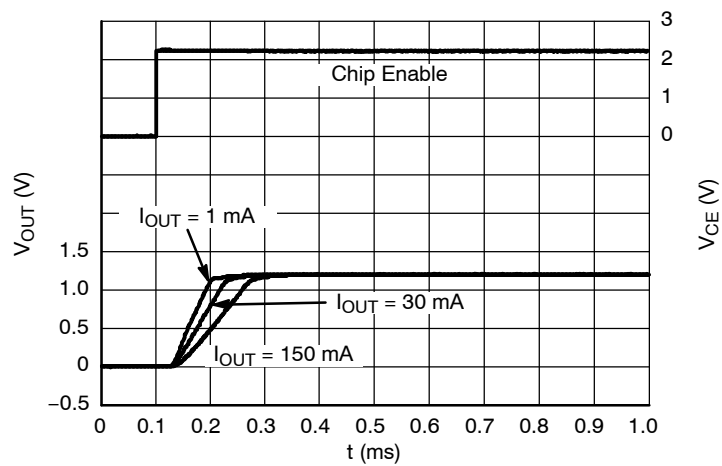

**Figure 51. Start-up, NCP4682 1.2 V Version,
 $V_{IN} = 2.2$ V**

NCP4682, NCP4685

TYPICAL CHARACTERISTICS

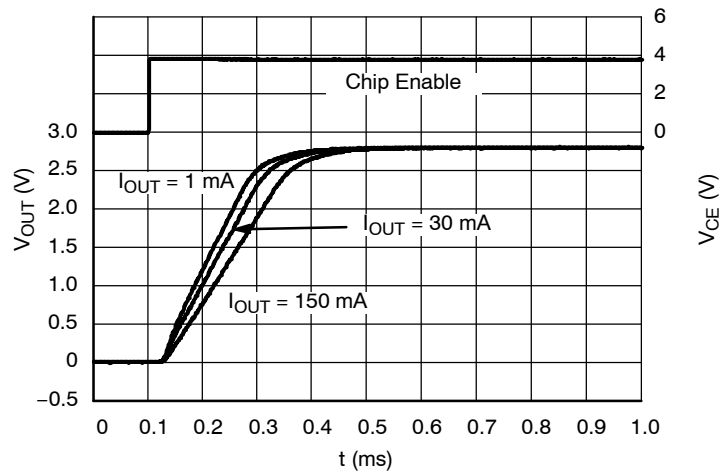

Figure 52. Start-up, NCP4682 2.8 V Version,
 $V_{IN} = 3.8$ V

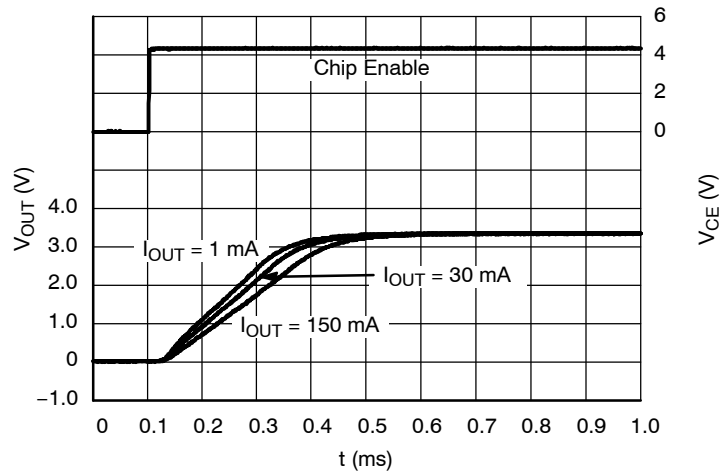

Figure 53. Start-up, NCP4682 3.3 V Version,
 $V_{IN} = 4.3$ V

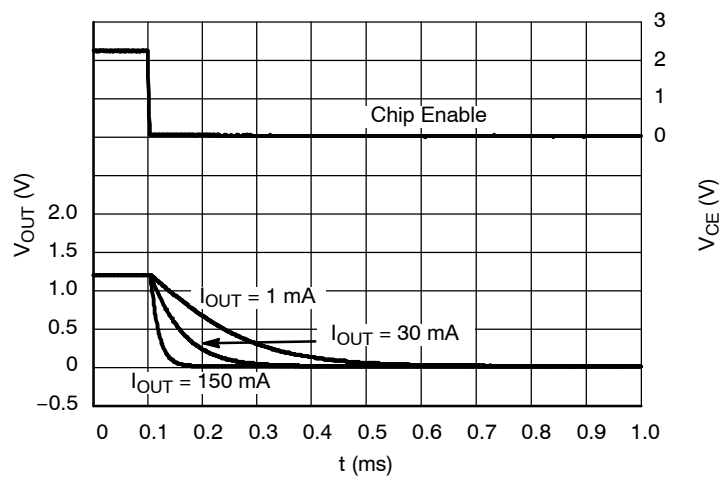

Figure 54. Shutdown, NCP4682 1.2 V Version D,
 $V_{IN} = 2.2$ V

NCP4682, NCP4685

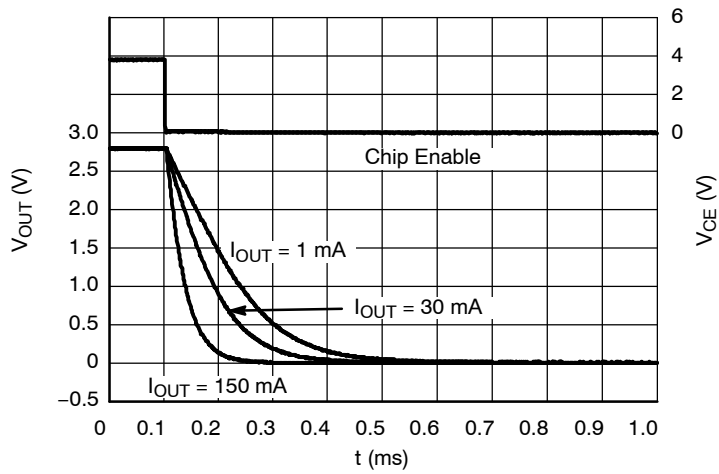

Figure 55. Shutdown, NCP4682 2.8 V Version D,
 $V_{IN} = 3.8$ V

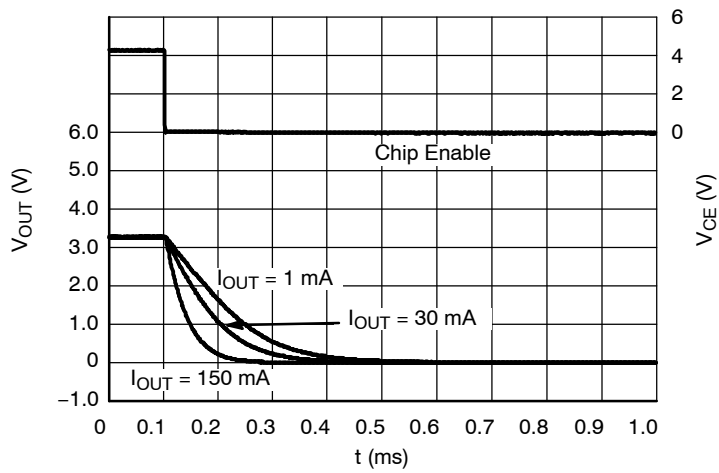

Figure 56. Shutdown, NCP4682 3.3 V Version D,
 $V_{IN} = 4.3$ V

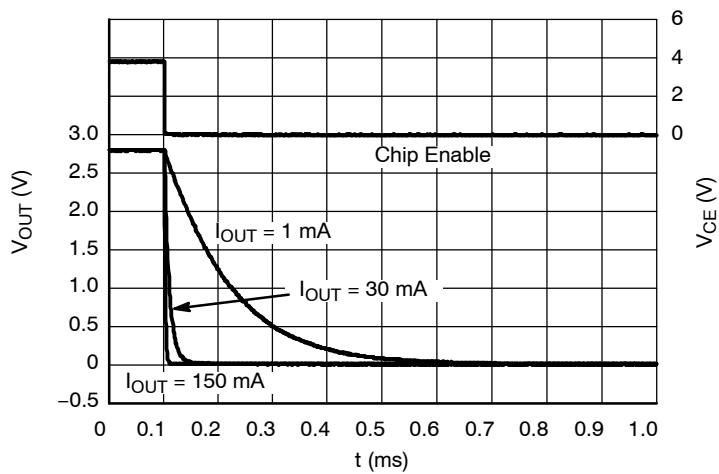

Figure 57. Shutdown, NCP4682 2.8 V Version H,
 $V_{IN} = 3.8$ V

APPLICATION INFORMATION

A typical application circuits for NCP4682 and NCP4685 series is shown in Figure 58.

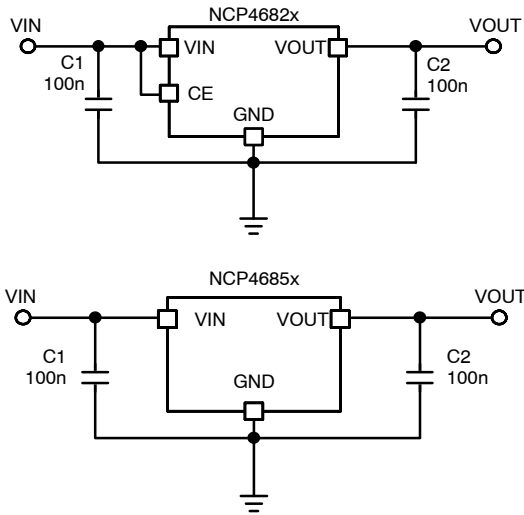

Figure 58. Typical Application Schematic

Input Decoupling Capacitor (C1)

A 0.1 μ F ceramic input decoupling capacitor should be connected as close as possible to the input and ground pin of the NCP4682/5. Higher values and lower ESR improves line transient response.

Output Decoupling Capacitor (C2)

A 0.1 μ F ceramic output decoupling capacitor is enough to achieve stable operation of the IC. If a tantalum capacitor is used, and its ESR is high, loop oscillation may result. The capacitors should be connected as close as possible to the output and ground pins. Larger values and lower ESR improves dynamic parameters.

Current Limit

This regulator includes a fold-back current limiting circuit. This type of protection doesn't limit output current

up to specified current capability in normal operation, but when an over current situation occurs, the output voltage and current decrease until the over current condition ends. Typical characteristics of this protection scheme are shown in the Output voltage versus Output current graphs in the characterization section of this datasheet.

Enable Operation (NCP4682 Only)

The enable pin CE may be used for turning the regulator on and off. The IC is switched on when a high level voltage is applied to the CE pin. The enable pin has an internal pull down current source. If the enable function is not needed, connect CE pin to VIN.

Output Discharger (NCP4682 Only)

The NCP4682D version includes a transistor between VOUT and GND that is used for faster discharging of the output capacitor. This function is activated when the IC goes into disable mode.

Thermals

As a power across the IC increase, it might become necessary to provide some thermal relief. The maximum power dissipation supported by the device is dependent upon board design and layout. Mounting pad configuration on the PCB, the board material, and also the ambient temperature affect the rate of temperature increase for the part. When the device has good thermal conductivity through the PCB the junction temperature will be relatively low in high power dissipation applications.

PCB layout

Make the VIN and GND line as large as practical. If their impedance is high, noise pickup or unstable operation may result. Connect capacitors C1 and C2 as close as possible to the IC, and make wiring as short as possible.

NCP4682, NCP4685

ORDERING INFORMATION

Device	Nominal Output Voltage	Description	Marking	Package	Shipping
NCP4682DMU12TCG	1.2 V	Auto discharge	CA	UDFN4 (Pb-Free)	10000 / Tape & Reel
NCP4682DMU15TCG	1.5 V	Auto discharge	CC		
NCP4682DMU18TCG	1.8 V	Auto discharge	CD		
NCP4682DMU19TCG	1.9 V	Auto discharge	CF		
NCP4682DMU25TCG	2.5 V	Auto discharge	CH		
NCP4682DMU28TCG	2.8 V	Auto discharge	CL		
NCP4682DMU30TCG	3.0 V	Auto discharge	CP		
NCP4682DMU33TCG	3.3 V	Auto discharge	CR		
NCP4682HMU18TCG	1.8 V	Enable high	AD		
NCP4682HMU28TCG	2.8 V	Enable high	AL		
NCP4682HMU33TCG	3.3 V	Enable high	AR		
NCP4685EMU30TCG	3.0 V	Without enable	BP		
NCP4682DSN30T1G	3.0 V	Auto discharge	92P	SOT-23-5 (Pb-Free)	3000 / Tape & Reel
NCP4682DSN33T1G	3.3 V	Auto discharge	92R		
NCP4682DSQ12T1G	1.2 V	Auto discharge	R0	SC-82AB (Pb-Free)	3000 / Tape & Reel
NCP4682DSQ15T1G	1.5 V	Auto discharge	R2		
NCP4682DSQ18T1G	1.8 V	Auto discharge	R3		
NCP4682DSQ20T1G	2.0 V	Auto discharge	R6		
NCP4682DSQ25T1G	2.5 V	Auto discharge	R7		
NCP4682DSQ28T1G	2.8 V	Auto discharge	S0		
NCP4682DSQ33T1G	3.3 V	Auto discharge	S5		
NCP4685ESQ15T1G	1.5 V	Without enable	N2		
NCP4685ESQ25T1G	2.5 V	Without enable	N7		
NCP4685ESQ33T1G	3.3 V	Without enable	P5		

†For information on tape and reel specifications, including part orientation and tape sizes, please refer to our Tape and Reel Packaging Specifications Brochure, BRD8011/D.

*To order other package and voltage variants, please contact your ON Semiconductor sales representative.

MECHANICAL CASE OUTLINE

PACKAGE DIMENSIONS

ON Semiconductor®



SCALE 2:1

SOT-23 5-LEAD CASE 1212-01 ISSUE A

DATE 28 JAN 2011

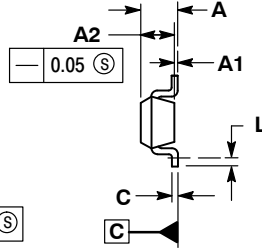
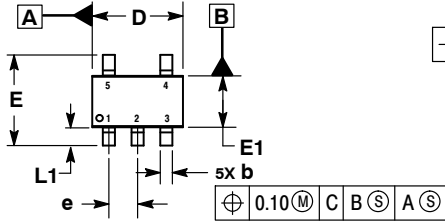

NOTES:

1. DIMENSIONING AND TOLERANCING PER ASME Y14.5M, 1994.
2. CONTROLLING DIMENSIONS: MILLIMETERS.
3. DATUM C IS THE SEATING PLANE.

MILLIMETERS		
DIM	MIN	MAX
A	---	1.45
A1	0.00	0.10
A2	1.00	1.30
b	0.30	0.50
c	0.10	0.25
D	2.70	3.10
E	2.50	3.10
E1	1.50	1.80
e	0.95 BSC	
L	0.20	---
L1	0.45	0.75

RECOMMENDED SOLDERING FOOTPRINT*

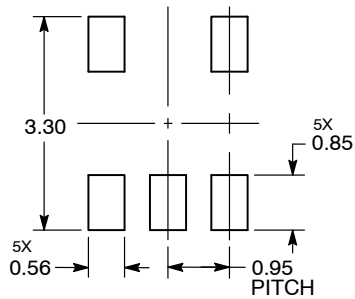

DIMENSIONS: MILLIMETERS

*For additional information on our Pb-Free strategy and soldering details, please download the ON Semiconductor Soldering and Mounting Techniques Reference Manual, SOLDERRM/D.

GENERIC MARKING DIAGRAM*

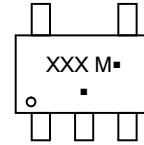

XXX = Specific Device Code

M = Date Code

▪ = Pb-Free Package

(Note: Microdot may be in either location)

*This information is generic. Please refer to device data sheet for actual part marking. Pb-Free indicator, "G" or microdot "▪", may or may not be present.

DOCUMENT NUMBER:	98ASH70518A	Electronic versions are uncontrolled except when accessed directly from the Document Repository. Printed versions are uncontrolled except when stamped "CONTROLLED COPY" in red.
DESCRIPTION:	SOT-23 5-LEAD	PAGE 1 OF 1

ON Semiconductor and are trademarks of Semiconductor Components Industries, LLC dba ON Semiconductor or its subsidiaries in the United States and/or other countries. ON Semiconductor reserves the right to make changes without further notice to any products herein. ON Semiconductor makes no warranty, representation or guarantee regarding the suitability of its products for any particular purpose, nor does ON Semiconductor assume any liability arising out of the application or use of any product or circuit, and specifically disclaims any and all liability, including without limitation special, consequential or incidental damages. ON Semiconductor does not convey any license under its patent rights nor the rights of others.

MECHANICAL CASE OUTLINE

PACKAGE DIMENSIONS

ON Semiconductor®

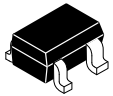

SC-82AB
CASE 419C-02
ISSUE F

DATE 22 JUN 2012

SCALE 4:1

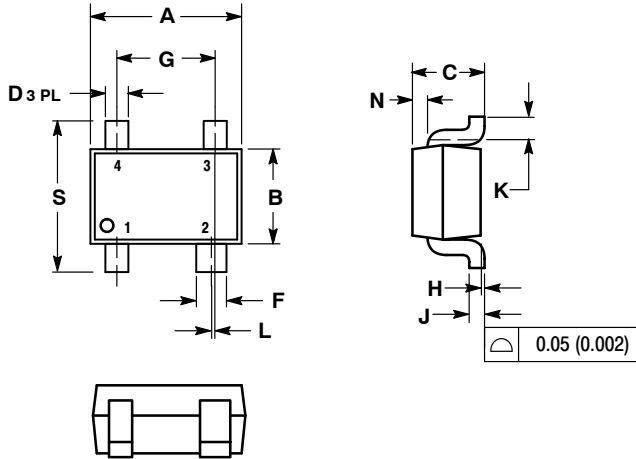

NOTES:

1. DIMENSIONING AND TOLERANCING PER ANSI Y14.5M, 1982.
2. CONTROLLING DIMENSION: MILLIMETER.
3. 419C-01 OBSOLETE. NEW STANDARD IS 419C-02.
4. DIMENSIONS A AND B DO NOT INCLUDE MOLD FLASH, PROTRUSIONS, OR GATE BURRS.

DIM	MILLIMETERS		INCHES	
	MIN	MAX	MIN	MAX
A	1.80	2.20	0.071	0.087
B	1.15	1.35	0.045	0.053
C	0.80	1.10	0.031	0.043
D	0.20	0.40	0.008	0.016
F	0.30	0.50	0.012	0.020
G	1.10	1.50	0.043	0.059
H	0.00	0.10	0.000	0.004
J	0.10	0.26	0.004	0.010
K	0.10	---	0.004	---
L	0.05 BSC		0.002 BSC	
N	0.20 REF		0.008 REF	
S	1.80	2.40	0.07	0.09

SOLDERING FOOTPRINT*

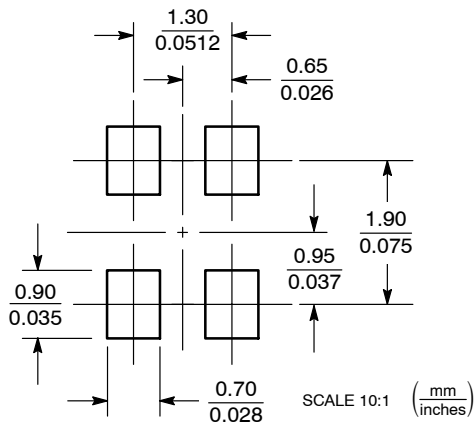

GENERIC MARKING DIAGRAM*

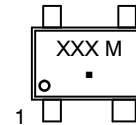

- XXX = Specific Device Code
- M = Month Code
- = Pb-Free Package

*This information is generic. Please refer to device data sheet for actual part marking. Pb-Free indicator, "G" or microdot "▪", may or may not be present.

*For additional information on our Pb-Free strategy and soldering details, please download the ON Semiconductor Soldering and Mounting Techniques Reference Manual, SOLDERRM/D.

DOCUMENT NUMBER:	98ARB18939C	Electronic versions are uncontrolled except when accessed directly from the Document Repository. Printed versions are uncontrolled except when stamped "CONTROLLED COPY" in red.
DESCRIPTION:	SC-82AB	PAGE 1 OF 1

ON Semiconductor and are trademarks of Semiconductor Components Industries, LLC dba ON Semiconductor or its subsidiaries in the United States and/or other countries. ON Semiconductor reserves the right to make changes without further notice to any products herein. ON Semiconductor makes no warranty, representation or guarantee regarding the suitability of its products for any particular purpose, nor does ON Semiconductor assume any liability arising out of the application or use of any product or circuit, and specifically disclaims any and all liability, including without limitation special, consequential or incidental damages. ON Semiconductor does not convey any license under its patent rights nor the rights of others.

MECHANICAL CASE OUTLINE PACKAGE DIMENSIONS

ON Semiconductor®



SCALE 4:1

UDFN4 1.0x1.0, 0.65P
CASE 517BR-01
ISSUE O

DATE 27 OCT 2010

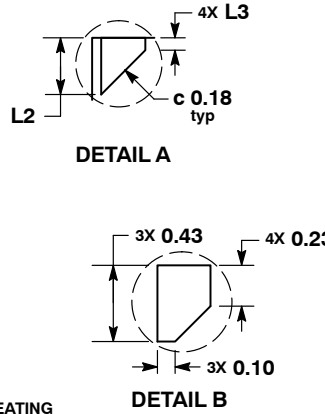
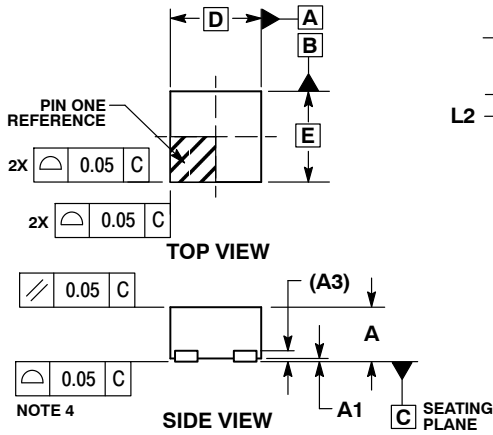

- NOTES:
1. DIMENSIONING AND TOLERANCING PER ASME Y14.5M, 1994.
 2. CONTROLLING DIMENSION: MILLIMETERS.
 3. DIMENSION b APPLIES TO PLATED TERMINAL AND IS MEASURED BETWEEN 0.15 AND 0.20 mm FROM TERMINAL.
 4. COPLANARITY APPLIES TO THE EXPOSED PAD AS WELL AS THE TERMINALS.

MILLIMETERS		
DIM	MIN	MAX
A	---	0.60
A1	0.00	0.05
A3	0.10	REF
b	0.20	0.30
D	1.00	BSC
D2	0.43	0.53
E	1.00	BSC
e	0.65	BSC
L	0.20	0.30
L2	0.27	0.37
L3	0.02	0.12

GENERIC MARKING DIAGRAM*

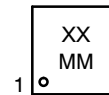

XX = Specific Device Code
MM = Date Code

*This information is generic. Please refer to device data sheet for actual part marking.
Pb-Free indicator, "G" or microdot "▪", may or may not be present.

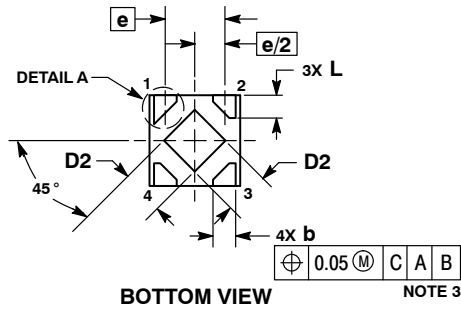

RECOMMENDED MOUNTING FOOTPRINT*

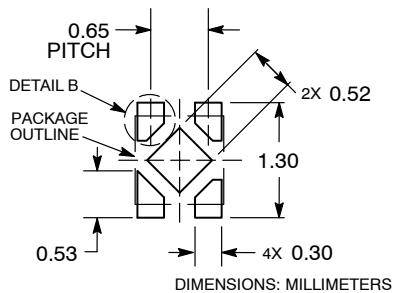

*For additional information on our Pb-Free strategy and soldering details, please download the ON Semiconductor Soldering and Mounting Techniques Reference Manual, SOLDERRM/D.

DOCUMENT NUMBER:	98AON53254E	Electronic versions are uncontrolled except when accessed directly from the Document Repository. Printed versions are uncontrolled except when stamped "CONTROLLED COPY" in red.
DESCRIPTION:	UDFN4, 1.0X1.0, 0.65P	PAGE 1 OF 1

ON Semiconductor and are trademarks of Semiconductor Components Industries, LLC dba ON Semiconductor or its subsidiaries in the United States and/or other countries. ON Semiconductor reserves the right to make changes without further notice to any products herein. ON Semiconductor makes no warranty, representation or guarantee regarding the suitability of its products for any particular purpose, nor does ON Semiconductor assume any liability arising out of the application or use of any product or circuit, and specifically disclaims any and all liability, including without limitation special, consequential or incidental damages. ON Semiconductor does not convey any license under its patent rights nor the rights of others.

ON Semiconductor and  are trademarks of Semiconductor Components Industries, LLC dba ON Semiconductor or its subsidiaries in the United States and/or other countries. ON Semiconductor owns the rights to a number of patents, trademarks, copyrights, trade secrets, and other intellectual property. A listing of ON Semiconductor's product/patent coverage may be accessed at www.onsemi.com/site/pdf/Patent-Marking.pdf. ON Semiconductor reserves the right to make changes without further notice to any products herein. ON Semiconductor makes no warranty, representation or guarantee regarding the suitability of its products for any particular purpose, nor does ON Semiconductor assume any liability arising out of the application or use of any product or circuit, and specifically disclaims any and all liability, including without limitation special, consequential or incidental damages. Buyer is responsible for its products and applications using ON Semiconductor products, including compliance with all laws, regulations and safety requirements or standards, regardless of any support or applications information provided by ON Semiconductor. "Typical" parameters which may be provided in ON Semiconductor data sheets and/or specifications can and do vary in different applications and actual performance may vary over time. All operating parameters, including "Typicals" must be validated for each customer application by customer's technical experts. ON Semiconductor does not convey any license under its patent rights nor the rights of others. ON Semiconductor products are not designed, intended, or authorized for use as a critical component in life support systems or any FDA Class 3 medical devices or medical devices with a same or similar classification in a foreign jurisdiction or any devices intended for implantation in the human body. Should Buyer purchase or use ON Semiconductor products for any such unintended or unauthorized application, Buyer shall indemnify and hold ON Semiconductor and its officers, employees, subsidiaries, affiliates, and distributors harmless against all claims, costs, damages, and expenses, and reasonable attorney fees arising out of, directly or indirectly, any claim of personal injury or death associated with such unintended or unauthorized use, even if such claim alleges that ON Semiconductor was negligent regarding the design or manufacture of the part. ON Semiconductor is an Equal Opportunity/Affirmative Action Employer. This literature is subject to all applicable copyright laws and is not for resale in any manner.

PUBLICATION ORDERING INFORMATION

LITERATURE FULFILLMENT:

Email Requests to: orderlit@onsemi.com

ON Semiconductor Website: www.onsemi.com

TECHNICAL SUPPORT

North American Technical Support:
Voice Mail: 1 800-282-9855 Toll Free USA/Canada
Phone: 011 421 33 790 2910

Europe, Middle East and Africa Technical Support:

Phone: 00421 33 790 2910

For additional information, please contact your local Sales Representative

