



Is Now Part of



**ON Semiconductor®**

To learn more about ON Semiconductor, please visit our website at  
[www.onsemi.com](http://www.onsemi.com)

Please note: As part of the Fairchild Semiconductor integration, some of the Fairchild orderable part numbers will need to change in order to meet ON Semiconductor's system requirements. Since the ON Semiconductor product management systems do not have the ability to manage part nomenclature that utilizes an underscore (\_), the underscore (\_) in the Fairchild part numbers will be changed to a dash (-). This document may contain device numbers with an underscore (\_). Please check the ON Semiconductor website to verify the updated device numbers. The most current and up-to-date ordering information can be found at [www.onsemi.com](http://www.onsemi.com). Please email any questions regarding the system integration to [Fairchild\\_questions@onsemi.com](mailto:Fairchild_questions@onsemi.com).

ON Semiconductor and the ON Semiconductor logo are trademarks of Semiconductor Components Industries, LLC dba ON Semiconductor or its subsidiaries in the United States and/or other countries. ON Semiconductor owns the rights to a number of patents, trademarks, copyrights, trade secrets, and other intellectual property. A listing of ON Semiconductor's product/patent coverage may be accessed at [www.onsemi.com/site/pdf/Patent-Marking.pdf](http://www.onsemi.com/site/pdf/Patent-Marking.pdf). ON Semiconductor reserves the right to make changes without further notice to any products herein. ON Semiconductor makes no warranty, representation or guarantee regarding the suitability of its products for any particular purpose, nor does ON Semiconductor assume any liability arising out of the application or use of any product or circuit, and specifically disclaims any and all liability, including without limitation special, consequential or incidental damages. Buyer is responsible for its products and applications using ON Semiconductor products, including compliance with all laws, regulations and safety requirements or standards, regardless of any support or applications information provided by ON Semiconductor. "Typical" parameters which may be provided in ON Semiconductor data sheets and/or specifications can and do vary in different applications and actual performance may vary over time. All operating parameters, including "Typicals" must be validated for each customer application by customer's technical experts. ON Semiconductor does not convey any license under its patent rights nor the rights of others. ON Semiconductor products are not designed, intended, or authorized for use as a critical component in life support systems or any FDA Class 3 medical devices or medical devices with a same or similar classification in a foreign jurisdiction or any devices intended for implantation in the human body. Should Buyer purchase or use ON Semiconductor products for any such unintended or unauthorized application, Buyer shall indemnify and hold ON Semiconductor and its officers, employees, subsidiaries, affiliates, and distributors harmless against all claims, costs, damages, and expenses, and reasonable attorney fees arising out of, directly or indirectly, any claim of personal injury or death associated with such unintended or unauthorized use, even if such claim alleges that ON Semiconductor was negligent regarding the design or manufacture of the part. ON Semiconductor is an Equal Opportunity/Affirmative Action Employer. This literature is subject to all applicable copyright laws and is not for resale in any manner.

# KA1M0680B/KA1M0680RB/ KA1H0680B/KA1H0680RFB

## Fairchild Power Switch(FPS)

### Features

- Precision fixed operating frequency
- KA1M0680B,KA1M0680RB (67KHz)
- KA1H0680B,KA1H0680RFB (100KHz)
- Pulse by pulse over current limiting
- Over load protection
- Over voltage protection (Min. 23V)
- Internal thermal shutdown function
- Under voltage lockout
- Internal high voltage sense FET
- Latch up mode (KA1M0680B,KA1H0680B)
- Auto restart (KA1M0680RB,KA1H0680RFB)
- Soft start

### Description

The Fairchild Power Switch(FPS) product family is specially designed for an off-line SMPS with minimal external components. The Fairchild Power Switch(FPS) consist of high voltage power SenseFET and current mode PWM controller IC. PWM controller features integrated fixed oscillator, under voltage lock out, leading edge blanking, optimized gate turn-on/turn-off driver, thermal shut down protection, over voltage protection, temperature compensated precision current sources for loop compensation and fault protection circuit. compared to discrete MOSFET and controller or RCC switching converter solution, a Fairchild Power Switch(FPS) can reduce total component count, design size, weight and at the same time increase & efficiency, productivity, and system reliability. It has a basic platform well suited for cost effective design in either a flyback converter or a forward converter.

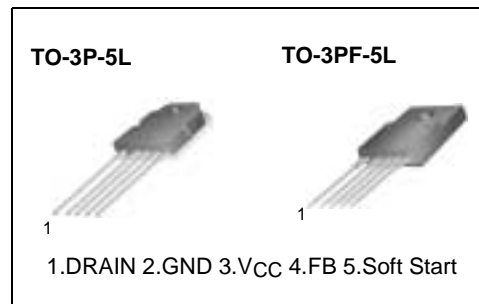

### Internal Block Diagram

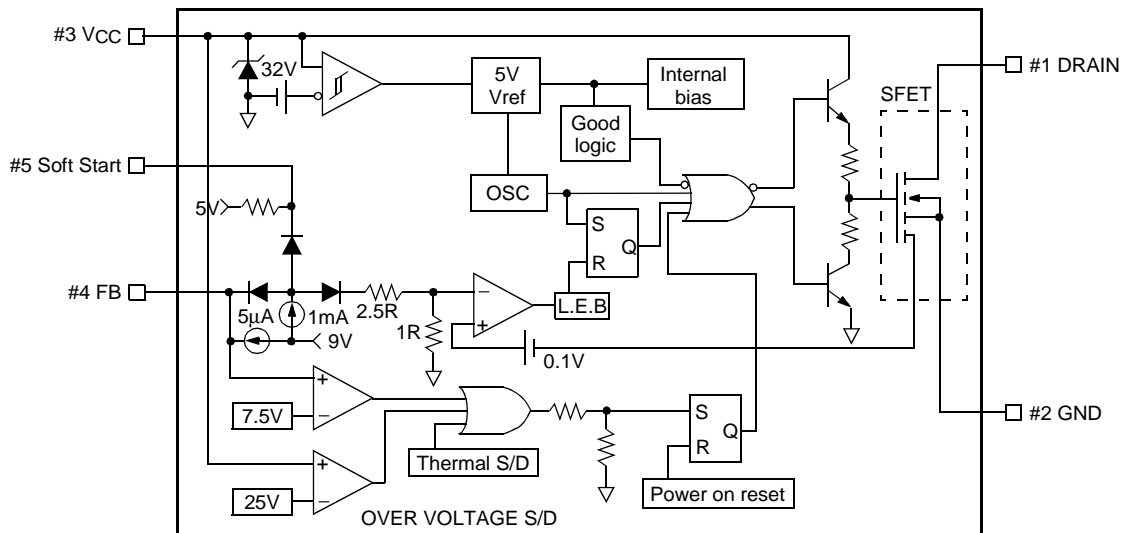

Rev.1.0.2

## Absolute Maximum Ratings

| Parameter                                        | Symbol              | Value                   | Unit |
|--------------------------------------------------|---------------------|-------------------------|------|
| Maximum Drain voltage <sup>(1)</sup>             | V <sub>D,MAX</sub>  | 800                     | V    |
| Drain Gate voltage (R <sub>GS</sub> =1MΩ)        | V <sub>DGR</sub>    | 800                     | V    |
| Gate source (GND) voltage                        | V <sub>GS</sub>     | ±30                     | V    |
| Drain current pulsed <sup>(2)</sup>              | I <sub>DM</sub>     | 24.0                    | ADC  |
| Single pulsed avalanche energy <sup>(3)</sup>    | E <sub>AS</sub>     | 455                     | mJ   |
| Avalanche current <sup>(4)</sup>                 | I <sub>AS</sub>     | 16                      | A    |
| Continuous drain current (T <sub>C</sub> =25°C)  | I <sub>D</sub>      | 6.0                     | ADC  |
| Continuous drain current (T <sub>C</sub> =100°C) | I <sub>D</sub>      | 4.0                     | ADC  |
| Maximum Supply voltage                           | V <sub>CC,MAX</sub> | 30                      | V    |
| Input voltage range                              | V <sub>FB</sub>     | -0.3 to V <sub>SD</sub> | V    |
| Total power dissipation                          | P <sub>D</sub>      | 150                     | W    |
|                                                  | Derating            | 1.21                    | W/°C |
| Operating ambient temperature                    | T <sub>A</sub>      | -25 to +85              | °C   |
| Storage temperature                              | T <sub>STG</sub>    | -55 to +150             | °C   |

### Notes:

1. T<sub>j</sub>=25°C to 150°C
2. Repetitive rating: Pulse width limited by maximum junction temperature
3. L=24mH, V<sub>DD</sub>=50V, R<sub>G</sub>=25Ω, starting T<sub>j</sub>=25°C
4. L=13μH, starting T<sub>j</sub>=25°C

## Electrical Characteristics (SFET part)

(Ta=25°C unless otherwise specified)

| Parameter                                           | Symbol              | Condition                                                                                                                                                                  | Min. | Typ. | Max. | Unit |
|-----------------------------------------------------|---------------------|----------------------------------------------------------------------------------------------------------------------------------------------------------------------------|------|------|------|------|
| Drain source breakdown voltage                      | BV <sub>DSS</sub>   | V <sub>GS</sub> =0V, I <sub>D</sub> =50μA                                                                                                                                  | 800  | -    | -    | V    |
| Zero gate voltage drain current                     | I <sub>DSS</sub>    | V <sub>DS</sub> =Max., Rating,<br>V <sub>GS</sub> =0V                                                                                                                      | -    | -    | 50   | μA   |
|                                                     |                     | V <sub>DS</sub> =0.8Max., Rating,<br>V <sub>GS</sub> =0V, T <sub>C</sub> =125°C                                                                                            | -    | -    | 200  | μA   |
| Static drain source on resistance <sup>(note)</sup> | R <sub>DS(ON)</sub> | V <sub>GS</sub> =10V, I <sub>D</sub> =4.0A                                                                                                                                 | -    | 1.6  | 2.0  | Ω    |
| Forward transconductance <sup>(note)</sup>          | g <sub>fs</sub>     | V <sub>DS</sub> =15V, I <sub>D</sub> =4.0A                                                                                                                                 | 1.5  | 2.5  | -    | S    |
| Input capacitance                                   | C <sub>iss</sub>    | V <sub>GS</sub> =0V, V <sub>DS</sub> =25V,<br>f=1MHz                                                                                                                       | -    | 1600 | -    | pF   |
| Output capacitance                                  | C <sub>oss</sub>    |                                                                                                                                                                            | -    | 140  | -    |      |
| Reverse transfer capacitance                        | C <sub>rss</sub>    |                                                                                                                                                                            | -    | 42   | -    |      |
| Turn on delay time                                  | t <sub>d(on)</sub>  | V <sub>DD</sub> =0.5BV <sub>DSS</sub> , I <sub>D</sub> =6.0A<br>(MOSFET switching<br>time are essentially<br>independent of<br>operating temperature)                      | -    | 60   | -    | nS   |
| Rise time                                           | t <sub>r</sub>      |                                                                                                                                                                            | -    | 150  | -    |      |
| Turn off delay time                                 | t <sub>d(off)</sub> |                                                                                                                                                                            | -    | 300  | -    |      |
| Fall time                                           | t <sub>f</sub>      |                                                                                                                                                                            | -    | 130  | -    |      |
| Total gate charge<br>(gate-source+gate-drain)       | Q <sub>g</sub>      | V <sub>GS</sub> =10V, I <sub>D</sub> =6.0A,<br>V <sub>DS</sub> =0.5BV <sub>DSS</sub> (MOSFET<br>switching time are<br>essentially independent of<br>operating temperature) | -    | 70   | -    | nC   |
| Gate source charge                                  | Q <sub>gs</sub>     |                                                                                                                                                                            | -    | 16   | -    |      |
| Gate drain (Miller) charge                          | Q <sub>gd</sub>     |                                                                                                                                                                            | -    | 27   | -    |      |

**Note:**

Pulse test: Pulse width ≤ 300μS, duty cycle ≤ 2%

$$S = \frac{1}{R}$$

## Electrical Characteristics (CONTROL part)

(Ta=25°C unless otherwise specified)

| Parameter                                                     | Symbol               | Condition                                       | Min. | Typ. | Max. | Unit  |
|---------------------------------------------------------------|----------------------|-------------------------------------------------|------|------|------|-------|
| <b>UVLO SECTION</b>                                           |                      |                                                 |      |      |      |       |
| Start threshold voltage                                       | V <sub>START</sub>   | -                                               | 14   | 15   | 16   | V     |
| Stop threshold voltage                                        | V <sub>STOP</sub>    | After turn on                                   | 9    | 10   | 11   | V     |
| <b>OSCILLATOR SECTION</b>                                     |                      |                                                 |      |      |      |       |
| Initial accuracy                                              | F <sub>OSC</sub>     | KA1M0680B                                       | 61   | 67   | 73   | kHz   |
|                                                               |                      | KA1M0680RB                                      | 61   | 67   | 73   |       |
|                                                               |                      | KA1H0680B                                       | 90   | 100  | 110  |       |
|                                                               |                      | KA1H0680RFB                                     | 90   | 100  | 110  |       |
| Frequency change with temperature <sup>(2)</sup>              | ΔF/ΔT                | -25°C ≤ Ta ≤ +85°C                              | -    | ±5   | ±10  | %     |
| Maximum duty cycle                                            | D <sub>max</sub>     | KA1M0680B                                       | 74   | 77   | 80   | %     |
|                                                               |                      | KA1M0680RB                                      | 74   | 77   | 80   |       |
|                                                               |                      | KA1H0680B                                       | 64   | 67   | 70   |       |
|                                                               |                      | KA1H0680RFB                                     | 64   | 67   | 70   |       |
| <b>FEEDBACK SECTION</b>                                       |                      |                                                 |      |      |      |       |
| Feedback source current                                       | I <sub>FB</sub>      | Ta=25°C, 0V ≤ V <sub>fb</sub> ≤ 3V              | 0.7  | 0.9  | 1.1  | mA    |
| Shutdown Feedback voltage                                     | V <sub>SD</sub>      | -                                               | 6.9  | 7.5  | 8.1  | V     |
| Shutdown delay current                                        | I <sub>delay</sub>   | Ta=25°C, 5V ≤ V <sub>fb</sub> ≤ V <sub>SD</sub> | 4.0  | 5.0  | 6.0  | μA    |
| <b>SOFT START SECTION</b>                                     |                      |                                                 |      |      |      |       |
| Soft Start Voltage                                            | V <sub>SS</sub>      | V <sub>FB</sub> = 2V                            | 4.7  | 5.0  | 5.3  | V     |
| Soft Start Current                                            | I <sub>SS</sub>      | Sync & S/S=GND                                  | 0.8  | 1.0  | 1.2  | mA    |
| <b>REFERENCE SECTION</b>                                      |                      |                                                 |      |      |      |       |
| Output voltage <sup>(1)</sup>                                 | V <sub>ref</sub>     | Ta=25°C                                         | 4.80 | 5.00 | 5.20 | V     |
| Temperature Stability <sup>(1)(2)</sup>                       | V <sub>ref</sub> /ΔT | -25°C ≤ Ta ≤ +85°C                              | -    | 0.3  | 0.6  | mV/°C |
| <b>CURRENT LIMIT (SELF-PROTECTION) SECTION</b>                |                      |                                                 |      |      |      |       |
| Peak Current Limit                                            | I <sub>OVER</sub>    | Max. inductor current                           | 3.52 | 4.00 | 4.48 | A     |
| <b>PROTECTION SECTION</b>                                     |                      |                                                 |      |      |      |       |
| Thermal shutdown temperature (T <sub>j</sub> ) <sup>(1)</sup> | T <sub>SD</sub>      | -                                               | 140  | 160  | -    | °C    |
| Over voltage protection voltage                               | V <sub>OVP</sub>     | -                                               | 23   | 25   | 28   | V     |
| <b>TOTAL DEVICE SECTION</b>                                   |                      |                                                 |      |      |      |       |
| Start Up current                                              | I <sub>START</sub>   | V <sub>CC</sub> =14V                            | 0.1  | 0.3  | 0.45 | mA    |
| Operating supply current (control part only)                  | I <sub>OP</sub>      | Ta=25°C                                         | 6    | 12   | 18   | mA    |
| V <sub>CC</sub> zener voltage                                 | V <sub>Z</sub>       | I <sub>CC</sub> =20mA                           | 30   | 32.5 | 35   | V     |

**Note:**

1. These parameters, although guaranteed, are not 100% tested in production
2. These parameters, although guaranteed, are tested in EDS (wafer test) process

## Typical Performance Characteristics

(These characteristic graphs are normalized at  $T_a=25^\circ\text{C}$ )

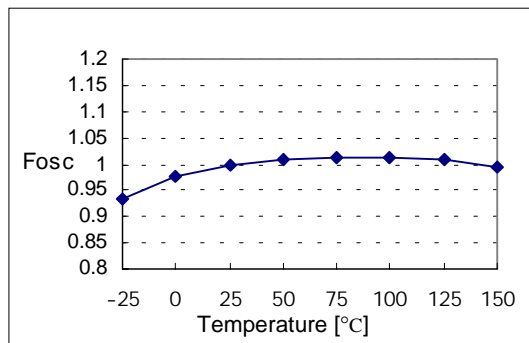

Figure 1. Operating Frequency

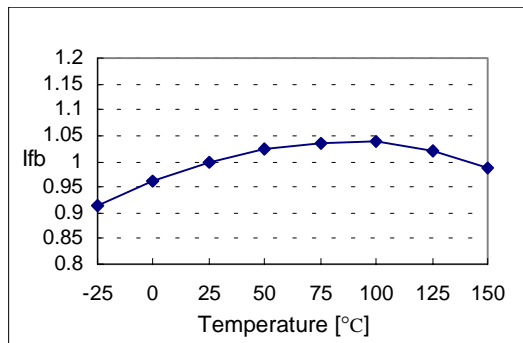

Figure 2. Feedback Source Current

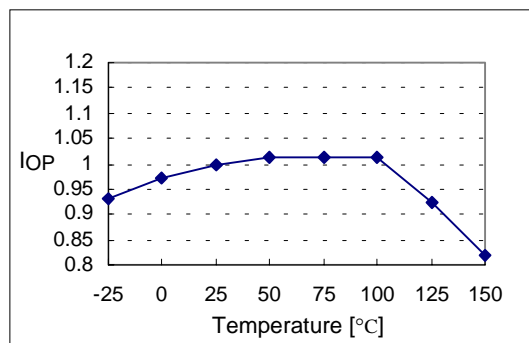

Figure 3. Operating Supply Current

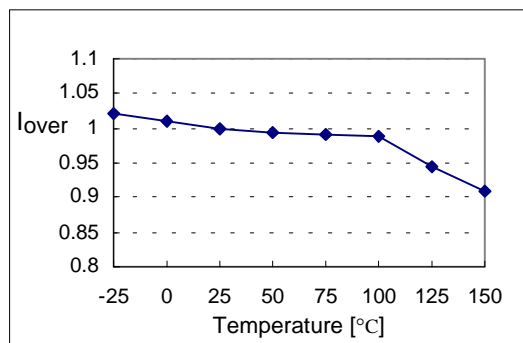

Figure 4. Peak Current Limit

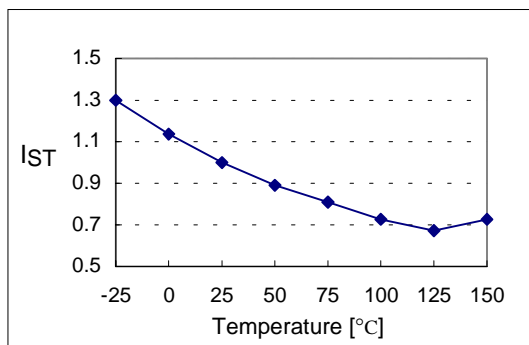

Figure 5. Start up Current

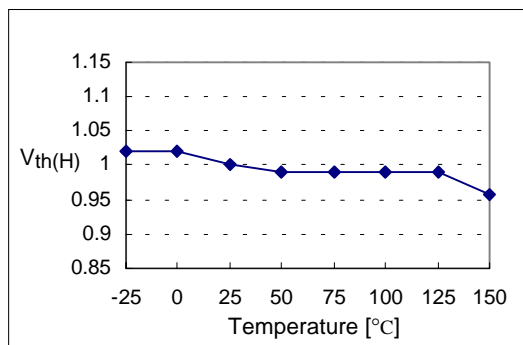

Figure 6. Start Threshold Voltage

## Typical Performance Characteristics (Continued)

(These characteristic graphs are normalized at Ta=25°C)

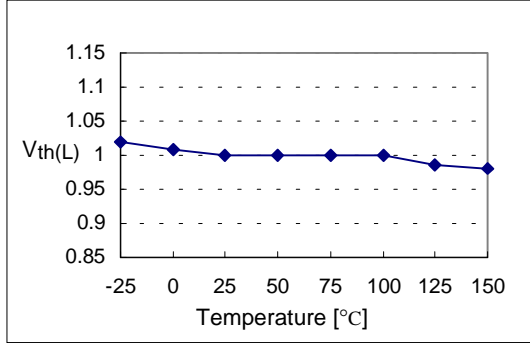

Figure 7. Stop Threshold Voltage

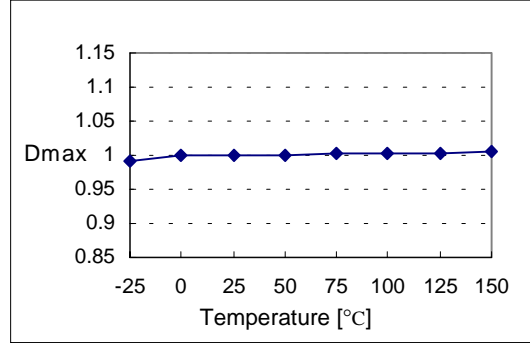

Figure 8. Maximum Duty Cycle

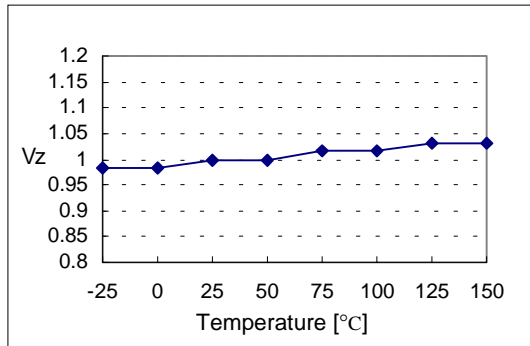

Figure 9. VCC Zener Voltage

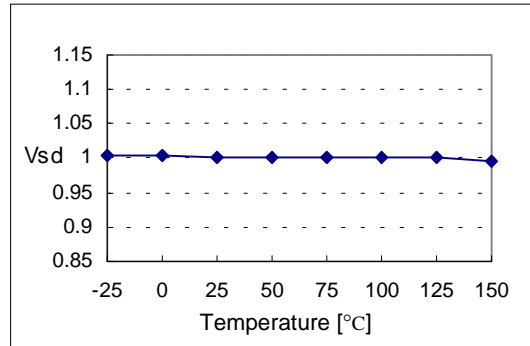

Figure 10. Shutdown Feedback Voltage

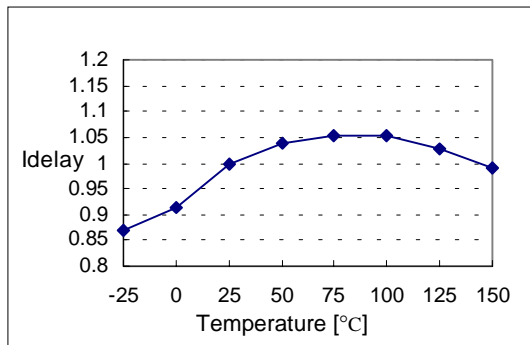

Figure 11. Shutdown Delay Current

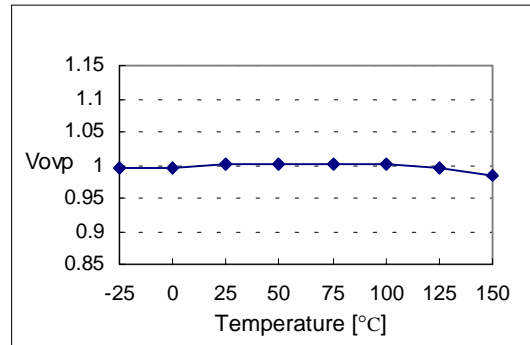

Figure 12. Over Voltage Protection

## Typical Performance Characteristics (Continued)

(These characteristic graphs are normalized at  $T_a=25^\circ\text{C}$ )

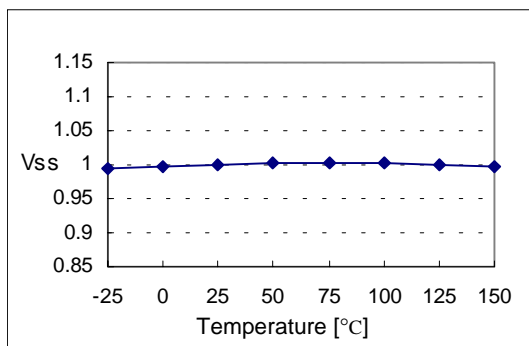

Figure 13. Soft Start Voltage

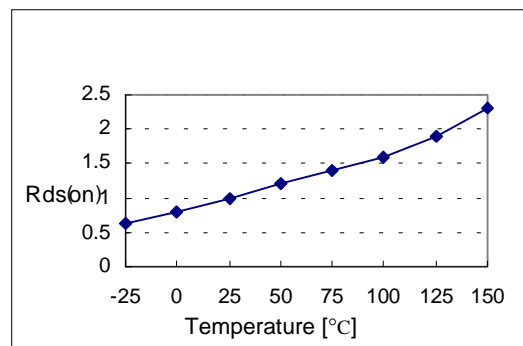
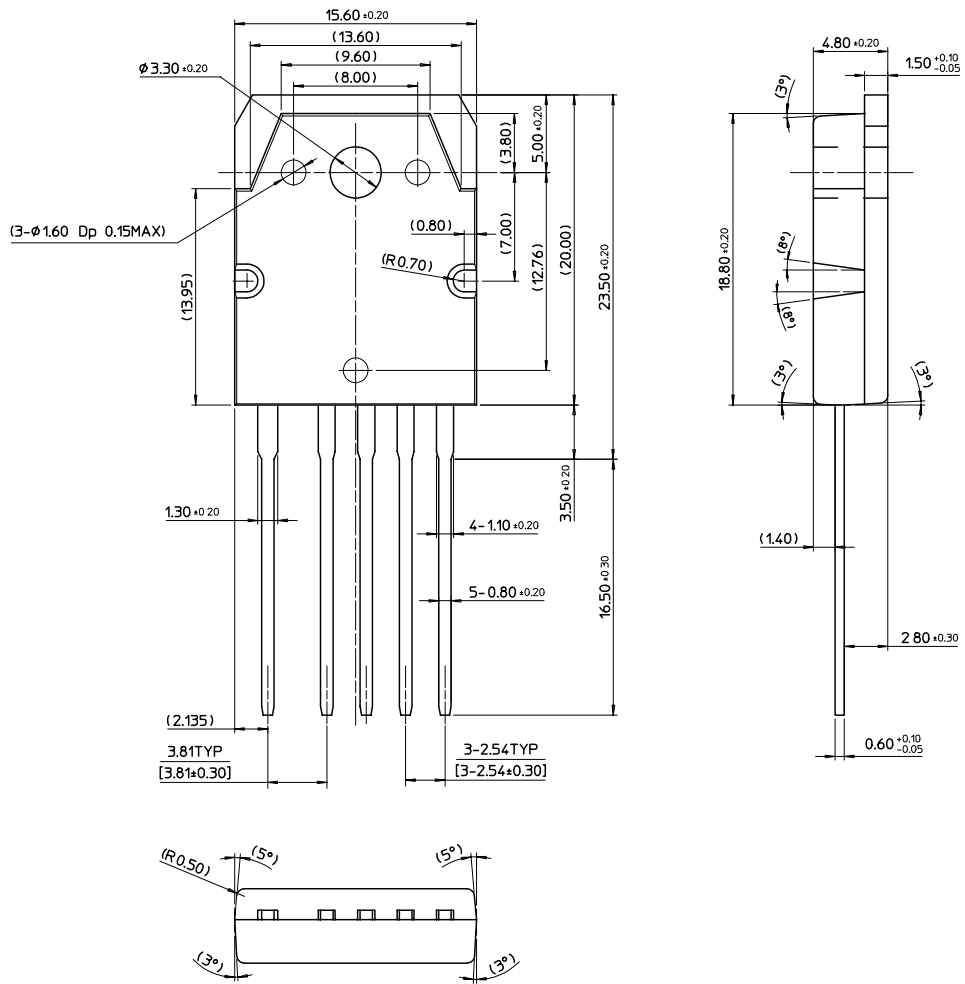

Figure 14. Static Drain-Source on Resistance



# Package Dimensions

## TO-3P-5L



Package Dimensions (Continued)

TO-3P-5L (Forming)

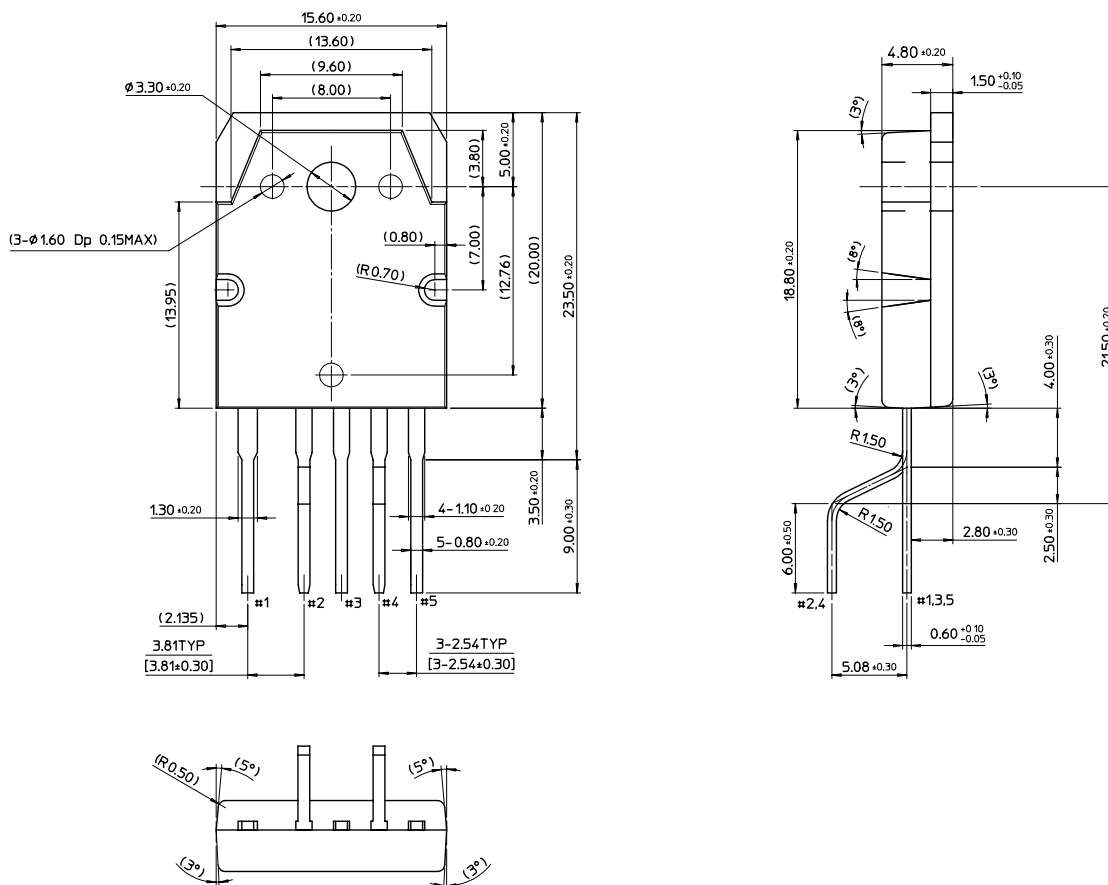

Package Dimensions (Continued)

TO-3PF-5L

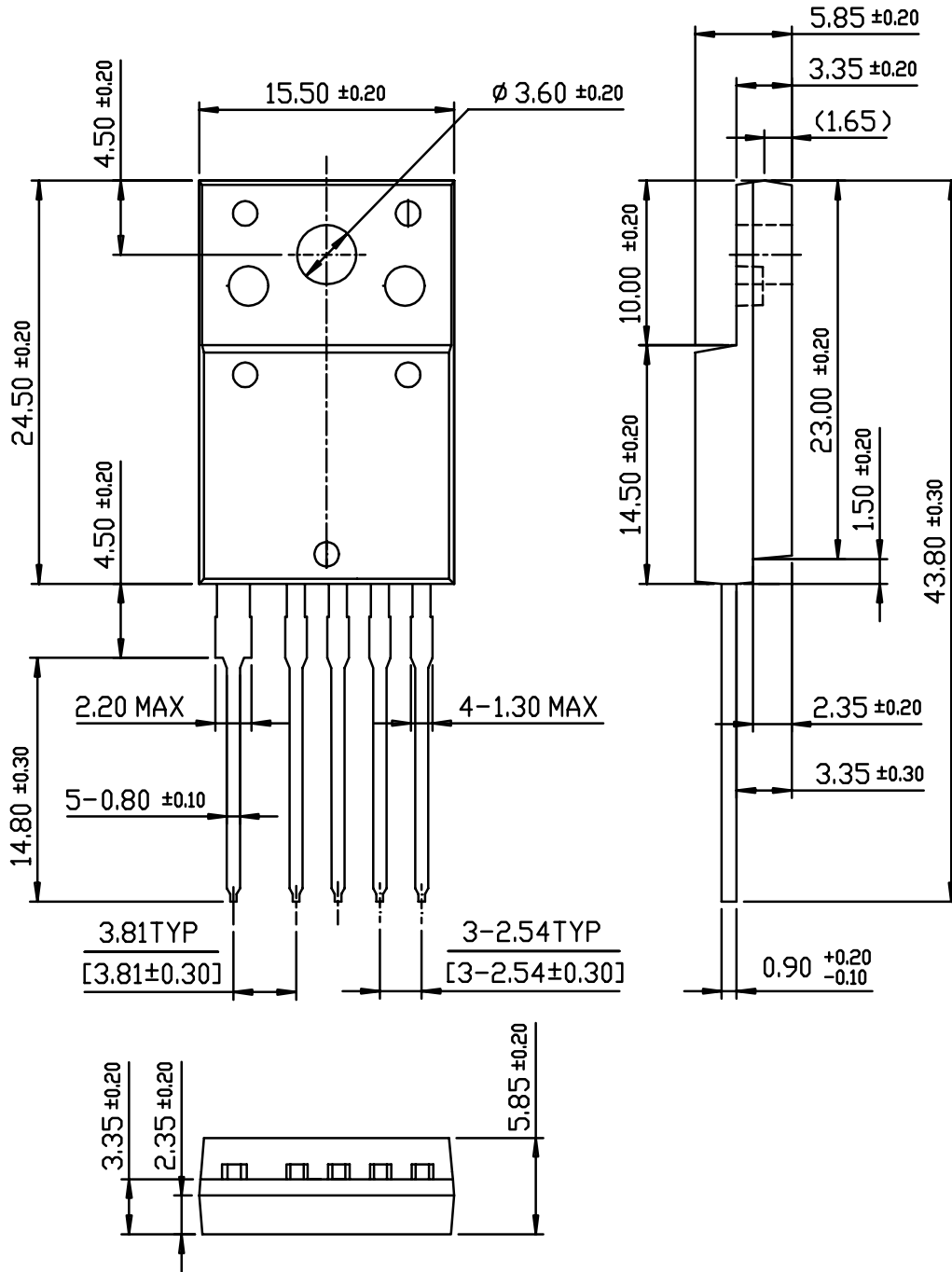

Package Dimensions (Continued)

TO-3PF-5L(Forming)

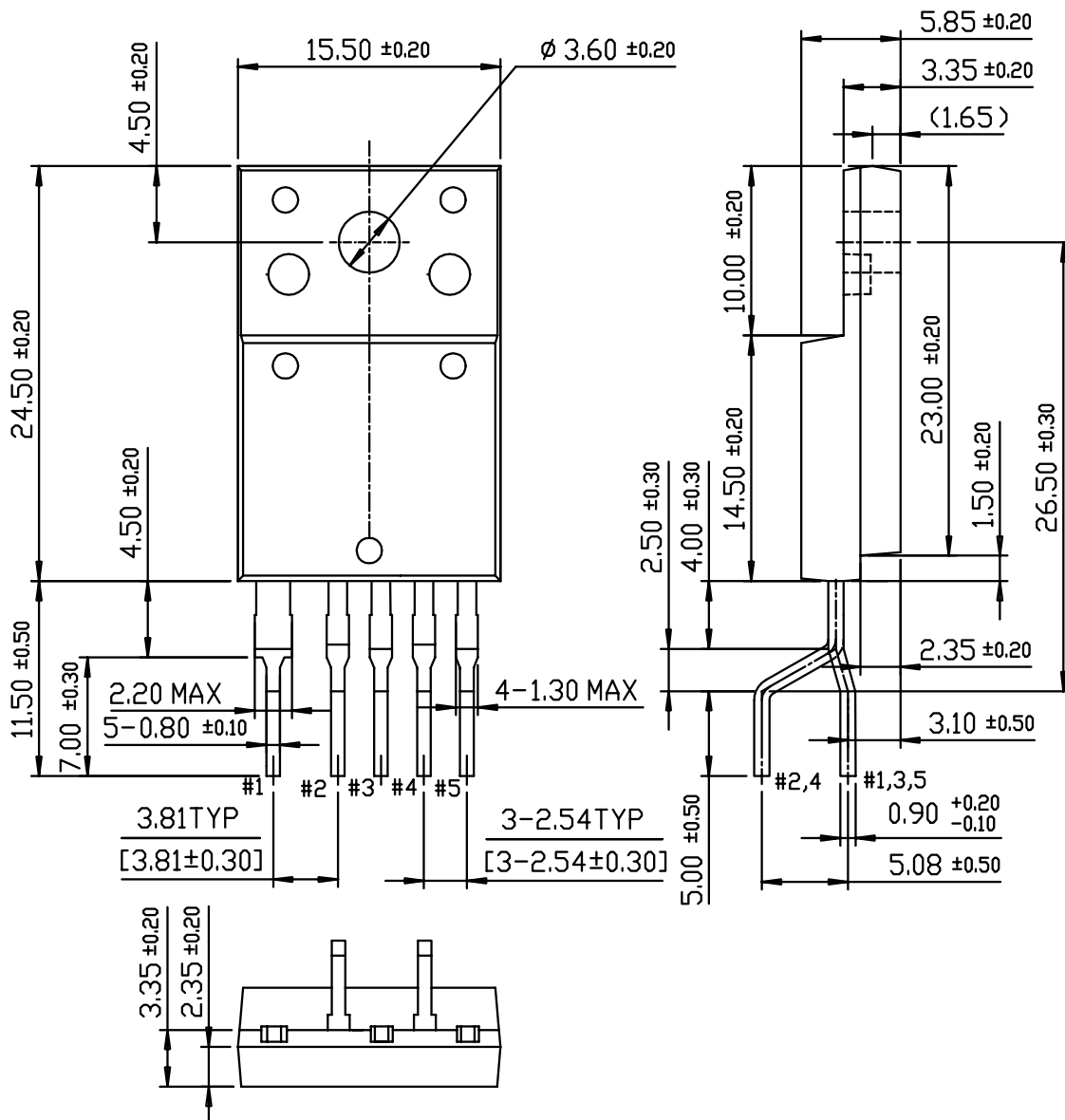

## Ordering Information

| Product Number   | Package            | Rating   | Fosc   | Latch/Auto        |
|------------------|--------------------|----------|--------|-------------------|
| KA1M0680B-TU     | TO-3P-5L           | 800V, 6A | 67kHz  | Latch up mode     |
| KA1M0680B-YDTU   | TO-3P-5L(Forming)  |          |        |                   |
| KA1M0680RB-TU    | TO-3P-5L           | 800V, 6A | 67kHz  | Auto restart mode |
| KA1M0680RB-YDTU  | TO-3P-5L(Forming)  |          |        |                   |
| KA1H0680B-TU     | TO-3P-5L           | 800V, 6A | 100kHz | Latch up mode     |
| KA1H0680B-YDTU   | TO-3P-5L(Forming)  |          |        |                   |
| KA1H0680RFB-TU   | TO-3PF-5L          | 800V, 6A | 100kHz | Auto restart mode |
| KA1H0680RFB-YDTU | TO-3PF-5L(Forming) |          |        |                   |

TU : Non Forming Type

YDTU : Forming Type

### DISCLAIMER

FAIRCHILD SEMICONDUCTOR RESERVES THE RIGHT TO MAKE CHANGES WITHOUT FURTHER NOTICE TO ANY PRODUCTS HEREIN TO IMPROVE RELIABILITY, FUNCTION OR DESIGN. FAIRCHILD DOES NOT ASSUME ANY LIABILITY ARISING OUT OF THE APPLICATION OR USE OF ANY PRODUCT OR CIRCUIT DESCRIBED HEREIN; NEITHER DOES IT CONVEY ANY LICENSE UNDER ITS PATENT RIGHTS, NOR THE RIGHTS OF OTHERS.

### LIFE SUPPORT POLICY

FAIRCHILD'S PRODUCTS ARE NOT AUTHORIZED FOR USE AS CRITICAL COMPONENTS IN LIFE SUPPORT DEVICES OR SYSTEMS WITHOUT THE EXPRESS WRITTEN APPROVAL OF THE PRESIDENT OF FAIRCHILD SEMICONDUCTOR CORPORATION. As used herein:

1. Life support devices or systems are devices or systems which, (a) are intended for surgical implant into the body, or (b) support or sustain life, and (c) whose failure to perform when properly used in accordance with instructions for use provided in the labeling, can be reasonably expected to result in a significant injury of the user.
2. A critical component in any component of a life support device or system whose failure to perform can be reasonably expected to cause the failure of the life support device or system, or to affect its safety or effectiveness.

ON Semiconductor and  are trademarks of Semiconductor Components Industries, LLC dba ON Semiconductor or its subsidiaries in the United States and/or other countries. ON Semiconductor owns the rights to a number of patents, trademarks, copyrights, trade secrets, and other intellectual property. A listing of ON Semiconductor's product/patent coverage may be accessed at [www.onsemi.com/site/pdf/Patent-Marking.pdf](http://www.onsemi.com/site/pdf/Patent-Marking.pdf). ON Semiconductor reserves the right to make changes without further notice to any products herein. ON Semiconductor makes no warranty, representation or guarantee regarding the suitability of its products for any particular purpose, nor does ON Semiconductor assume any liability arising out of the application or use of any product or circuit, and specifically disclaims any and all liability, including without limitation special, consequential or incidental damages. Buyer is responsible for its products and applications using ON Semiconductor products, including compliance with all laws, regulations and safety requirements or standards, regardless of any support or applications information provided by ON Semiconductor. "Typical" parameters which may be provided in ON Semiconductor data sheets and/or specifications can and do vary in different applications and actual performance may vary over time. All operating parameters, including "Typicals" must be validated for each customer application by customer's technical experts. ON Semiconductor does not convey any license under its patent rights nor the rights of others. ON Semiconductor products are not designed, intended, or authorized for use as a critical component in life support systems or any FDA Class 3 medical devices or medical devices with a same or similar classification in a foreign jurisdiction or any devices intended for implantation in the human body. Should Buyer purchase or use ON Semiconductor products for any such unintended or unauthorized application, Buyer shall indemnify and hold ON Semiconductor and its officers, employees, subsidiaries, affiliates, and distributors harmless against all claims, costs, damages, and expenses, and reasonable attorney fees arising out of, directly or indirectly, any claim of personal injury or death associated with such unintended or unauthorized use, even if such claim alleges that ON Semiconductor was negligent regarding the design or manufacture of the part. ON Semiconductor is an Equal Opportunity/Affirmative Action Employer. This literature is subject to all applicable copyright laws and is not for resale in any manner.

## PUBLICATION ORDERING INFORMATION

### LITERATURE FULFILLMENT:

Literature Distribution Center for ON Semiconductor  
19521 E. 32nd Pkwy, Aurora, Colorado 80011 USA  
**Phone:** 303-675-2175 or 800-344-3860 Toll Free USA/Canada  
**Fax:** 303-675-2176 or 800-344-3867 Toll Free USA/Canada  
**Email:** [orderlit@onsemi.com](mailto:orderlit@onsemi.com)

**N. American Technical Support:** 800-282-9855 Toll Free  
USA/Canada  
**Europe, Middle East and Africa Technical Support:**  
Phone: 421 33 790 2910  
**Japan Customer Focus Center**  
Phone: 81-3-5817-1050

**ON Semiconductor Website:** [www.onsemi.com](http://www.onsemi.com)  
**Order Literature:** <http://www.onsemi.com/orderlit>  
For additional information, please contact your local  
Sales Representative