

KEMET, L-SWS, RF, 2700 nH, 5%

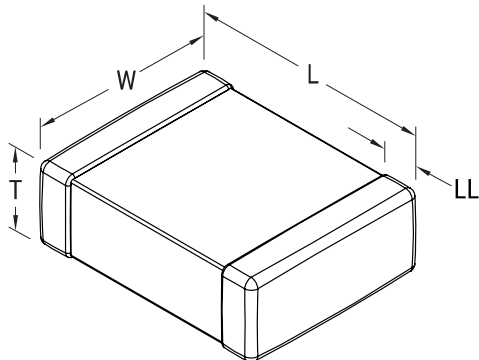

Dimensions	
Chip Size	0806
L	2mm +/-0.2mm
W	1.6mm +/-0.2mm
T	1.6mm +/-0.2mm
LL	0.5mm +/-0.2mm

Packaging Specifications	
Packaging:	T&R
Packaging Quantity:	2000

General Information	
Series:	L-SWS
Style:	SMD Chip
RoHS:	Yes

Specifications	
Inductance:	2.7 uH (7.96 MHz)
Inductance Tolerance:	5%
Current:	310 mAmps (MAX)
DC Resistance:	0.59 Ohms
Self-Resonant Frequency:	55 MHz MIN