

# NTJD1155L

## MOSFET – Power, P-Channel, High Side Load Switch with Level-Shift, SC-88 8 V, ±1.3 A

The NTJD1155L integrates a P and N-Channel MOSFET in a single package. This device is particularly suited for portable electronic equipment where low control signals, low battery voltages and high load currents are needed. The P-Channel device is specifically designed as a load switch using ON Semiconductor state-of-the-art trench technology. The N-Channel, with an external resistor (R1), functions as a level-shift to drive the P-Channel. The N-Channel MOSFET has internal ESD protection and can be driven by logic signals as low as 1.5 V. The NTJD1155L operates on supply lines from 1.8 to 8.0 V and can drive loads up to 1.3 A with 8.0 V applied to both  $V_{IN}$  and  $V_{ON/OFF}$ .

### Features

- Extremely Low  $R_{DS(on)}$  P-Channel Load Switch MOSFET
- Level Shift MOSFET is ESD Protected
- Low Profile, Small Footprint Package
- $V_{IN}$  Range 1.8 to 8.0 V
- ON/OFF Range 1.5 to 8.0 V
- These Devices are Pb-Free and are RoHS Compliant

### MAXIMUM RATINGS ( $T_J = 25^\circ\text{C}$ unless otherwise noted)

Rating		Symbol	Value	Unit
Input Voltage ( $V_{DSS}$ , P-Ch)		$V_{IN}$	8.0	V
ON/OFF Voltage ( $V_{GS}$ , N-Ch)		$V_{ON/OFF}$	8.0	V
Continuous Load Current (Note 1)	Steady State	$T_A = 25^\circ\text{C}$	$I_L$	±1.3
		$T_A = 85^\circ\text{C}$		
Power Dissipation (Note 1)	Steady State	$T_A = 25^\circ\text{C}$	$P_D$	0.40
		$T_A = 85^\circ\text{C}$		
Pulsed Load Current	$t_p = 10 \mu\text{s}$	$I_{LM}$	±3.9	A
Operating Junction and Storage Temperature		$T_J, T_{STG}$	-55 to 150	$^\circ\text{C}$
Source Current (Body Diode)		$I_S$	-0.4	A
Lead Temperature for Soldering Purposes (1/8" from case for 10 s)		$T_L$	260	$^\circ\text{C}$

### THERMAL CHARACTERISTICS

Characteristic	Symbol	Max	Unit
Junction-to-Ambient – Steady State (Note 1)	$R_{\theta JA}$	320	$^\circ\text{C}/\text{W}$
Junction-to-Foot – Steady State (Note 1)	$R_{\theta JF}$	220	

Stresses exceeding those listed in the Maximum Ratings table may damage the device. If any of these limits are exceeded, device functionality should not be assumed, damage may occur and reliability may be affected.



ON Semiconductor®

[www.onsemi.com](http://www.onsemi.com)

$V_{(BR)DSS}$	$R_{DS(on)}$ TYP	$I_D$ MAX
8.0 V	130 m $\Omega$ @ -4.5 V	±1.3 A
	170 m $\Omega$ @ -2.5 V	
	260 m $\Omega$ @ -1.8 V	

### SIMPLIFIED SCHEMATIC

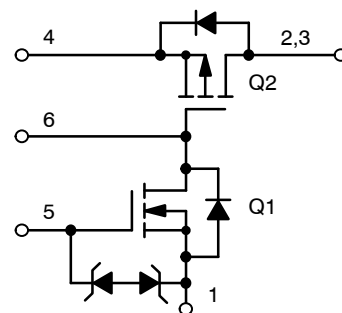

SC-88  
(SOT-363)  
CASE 419B  
STYLE 30

### MARKING DIAGRAM

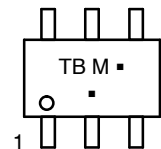

TB = Device Code  
M = Date Code  
▪ = Pb-Free Package

(Note: Microdot may be in either location)

### PIN ASSIGNMENT

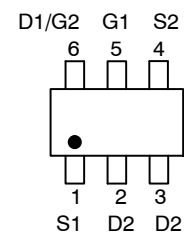

### ORDERING INFORMATION

Device	Package	Shipping†
NTJD1155LT1G, NTJD1155LT2G	SC-88 (Pb-Free)	3000/Tape & Reel

†For information on tape and reel specifications, including part orientation and tape sizes, please refer to our Tape and Reel Packaging Specification Brochure, BRD8011/D.

## NTJD1155L

1. Surface-mounted on FR4 board using 1 inch sq pad size  
(Cu area = 1.127 in sq [1 oz] including traces).

# NTJD1155L

## ELECTRICAL CHARACTERISTICS ( $T_J = 25^\circ\text{C}$ unless otherwise noted)

Characteristic	Symbol	Test Condition	Min	Typ	Max	Unit
<b>OFF CHARACTERISTICS</b>						
Q2 Drain-to-Source Breakdown Voltage	$V_{IN}$	$V_{GS2} = 0\text{ V}, I_{D2} = 250\ \mu\text{A}$	-8.0			V
Forward Leakage Current	$I_{FL}$	$V_{GS1} = 0\text{ V}, V_{DS2} = -8.0\text{ V}$	$T_J = 25^\circ\text{C}$		1.0	$\mu\text{A}$
			$T_J = 125^\circ\text{C}$		10	
Q1 Gate-to-Source Leakage Current	$I_{GSS}$	$V_{DS1} = 0\text{ V}, V_{GS1} = \pm 8.0\text{ V}$			$\pm 100$	nA
Q1 Diode Forward On-Voltage	$V_{SD}$	$I_S = -0.4\text{ A}, V_{GS1} = 0\text{ V}$		-0.8	-1.1	V

## ON CHARACTERISTICS

ON/OFF Voltage	$V_{ON/OFF}$		1.5		8.0	V	
Q1 Gate Threshold Voltage	$V_{GS1(th)}$	$V_{GS1} = V_{DS1}, I_D = 250\ \mu\text{A}$	0.4		1.0	V	
Input Voltage	$V_{IN}$	$V_{GS1} = V_{DS1}, I_D = 250\ \mu\text{A}$	1.8		8.0	V	
Q2 Drain-to-Source On Resistance	$R_{DS(on)}$	$V_{ON/OFF} = 1.5\text{ V}$	$V_{IN} = 4.5\text{ V}, I_L = 1.2\text{ A}$		130	175	$\text{m}\Omega$
			$V_{IN} = 2.5\text{ V}, I_L = 1.0\text{ A}$		170	220	
			$V_{IN} = 1.8\text{ V}, I_L = 0.7\text{ A}$		260	320	
Load Current	$I_L$	$V_{DROP} \leq 0.2\text{ V}, V_{IN} = 5.0\text{ V}, V_{ON/OFF} = 1.5\text{ V}$	1.0			A	
		$V_{DROP} \leq 0.3\text{ V}, V_{IN} = 2.5\text{ V}, V_{ON/OFF} = 1.5\text{ V}$	1.0				

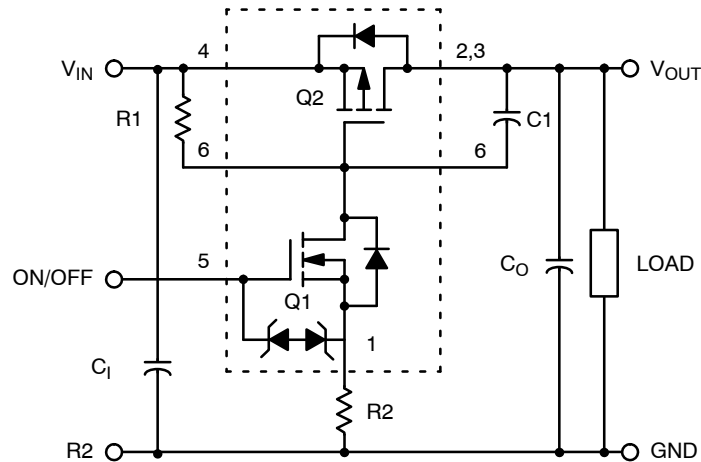

Figure 1. Load Switch Application

Components	Description	Values
R1	Pullup Resistor	Typical 10 k $\Omega$ to 1.0 M $\Omega$ *
R2	Optional Slew-Rate Control	Typical 0 to 100 k $\Omega$ *
$C_0, C_1$	Output Capacitance	Usually < 1.0 $\mu\text{F}$
C1	Optional In-Rush Current Control	Typical $\leq 1000\ \text{pF}$

\*Minimum R1 value should be at least 10 x R2 to ensure Q1 turn-on.

# NTJD1155L

## TYPICAL PERFORMANCE CURVES ( $T_J = 25^\circ\text{C}$ unless otherwise noted)

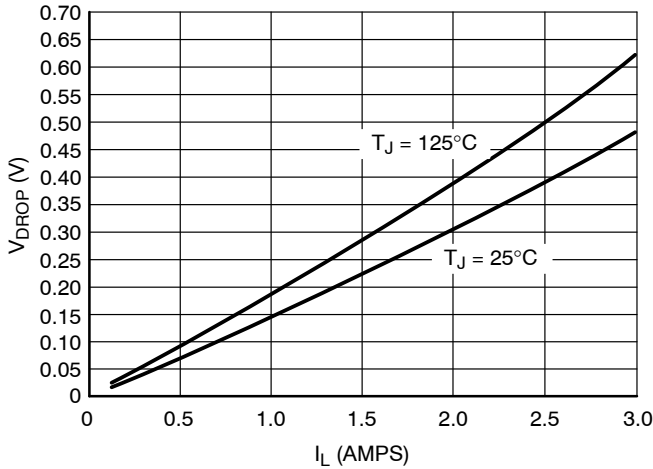

Figure 2.  $V_{\text{drop}}$  vs.  $I_L$  @  $V_{\text{in}} = 2.5 \text{ V}$

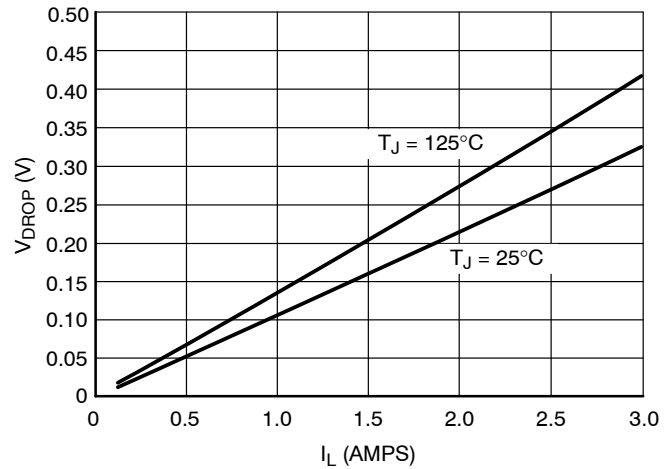

Figure 3.  $V_{\text{drop}}$  vs.  $I_L$  @  $V_{\text{in}} = 4.5 \text{ V}$

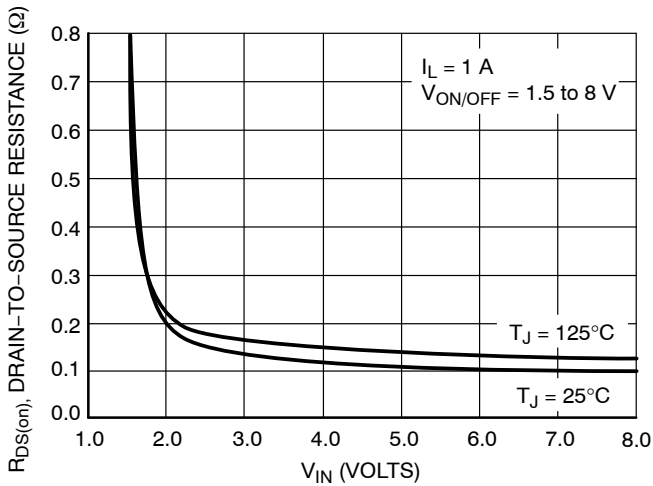

Figure 4. On-Resistance vs. Input Voltage

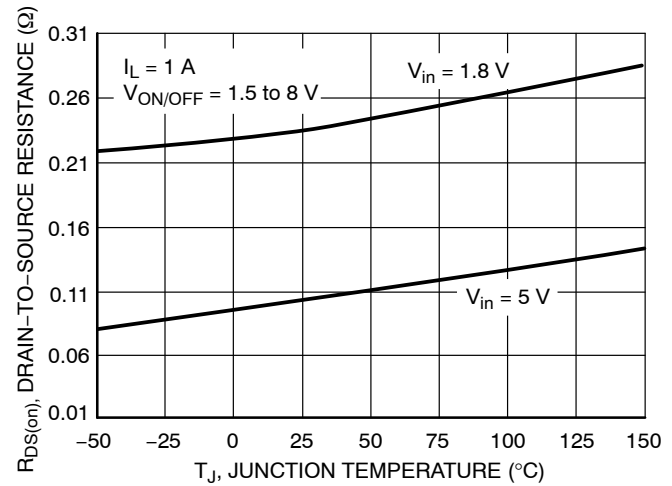

Figure 5. On-Resistance Variation with Temperature

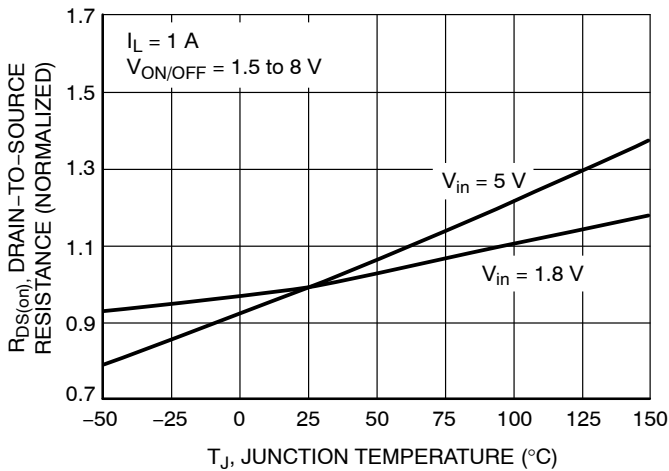

Figure 6. Normalized On-Resistance Variation with Temperature

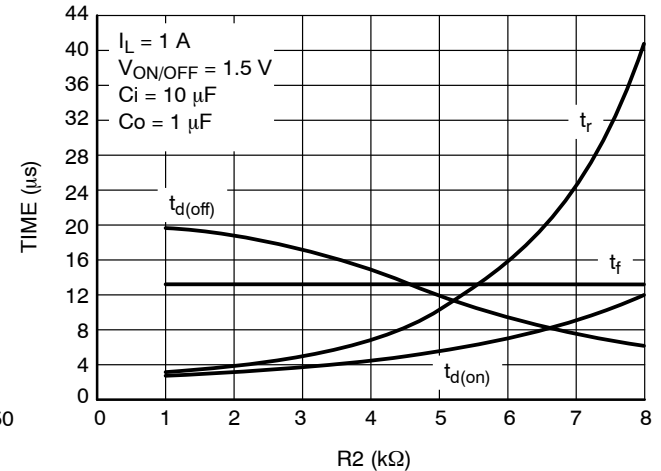
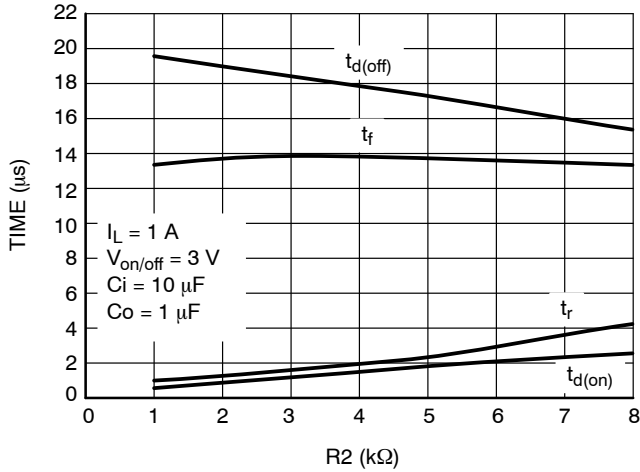

Figure 7. Switching Variation  $R_2$  @  $V_{\text{in}} = 4.5 \text{ V}$ ,  $R_1 = 20 \text{ k}\Omega$

# NTJD1155L

## TYPICAL PERFORMANCE CURVES ( $T_J = 25^\circ\text{C}$ unless otherwise noted)



**Figure 8. Switching Variation**  
R2 @  $V_{in} = 4.5\text{ V}$ ,  $R1 = 20\ \text{k}\Omega$

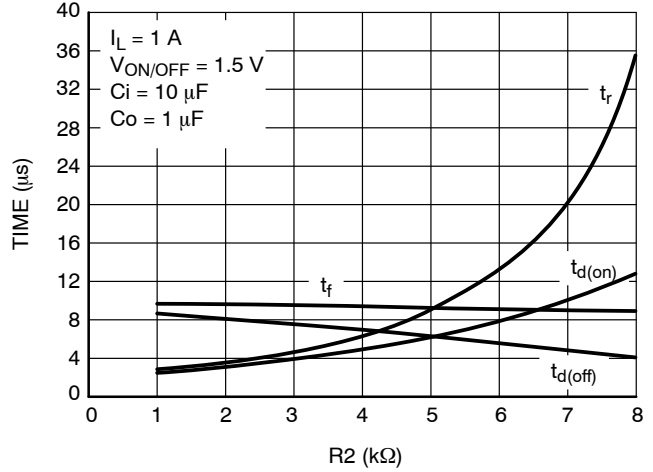

**Figure 9. Switching Variation**  
R2 @  $V_{in} = 2.5\text{ V}$ ,  $R1 = 20\ \text{k}\Omega$

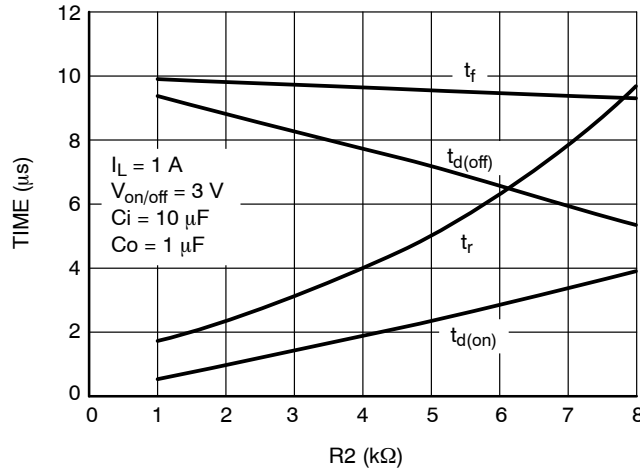

**Figure 10. Switching Variation**  
R2 @  $V_{in} = 2.5\text{ V}$ ,  $R1 = 20\ \text{k}\Omega$

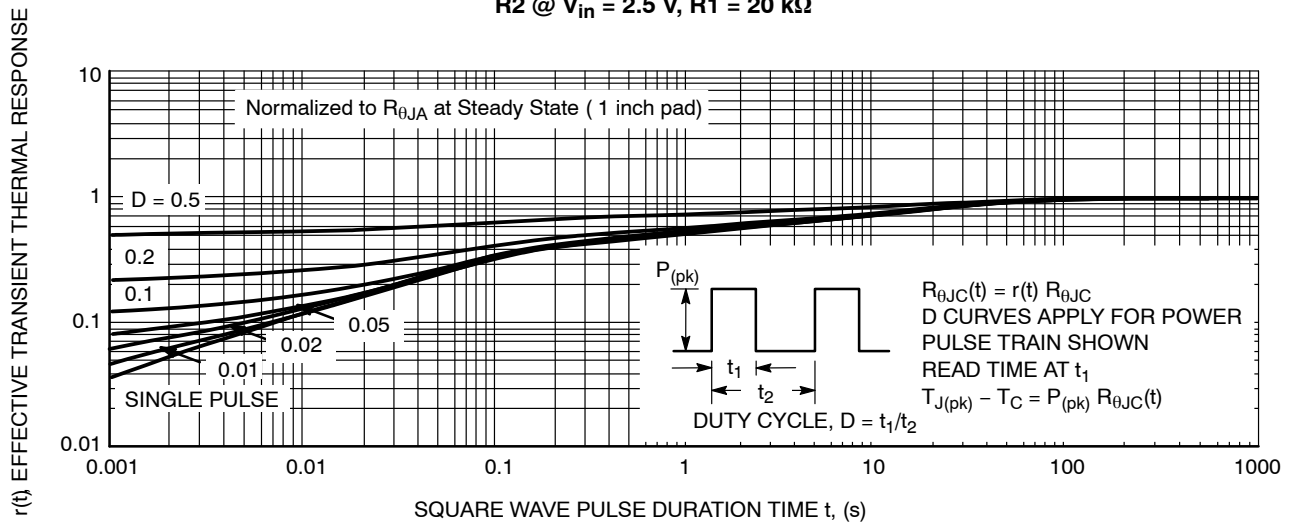

**Figure 11. FET Thermal Response**



1  
SCALE 2:1

SC-88/SC70-6/SOT-363  
CASE 419B-02  
ISSUE Y

DATE 11 DEC 2012

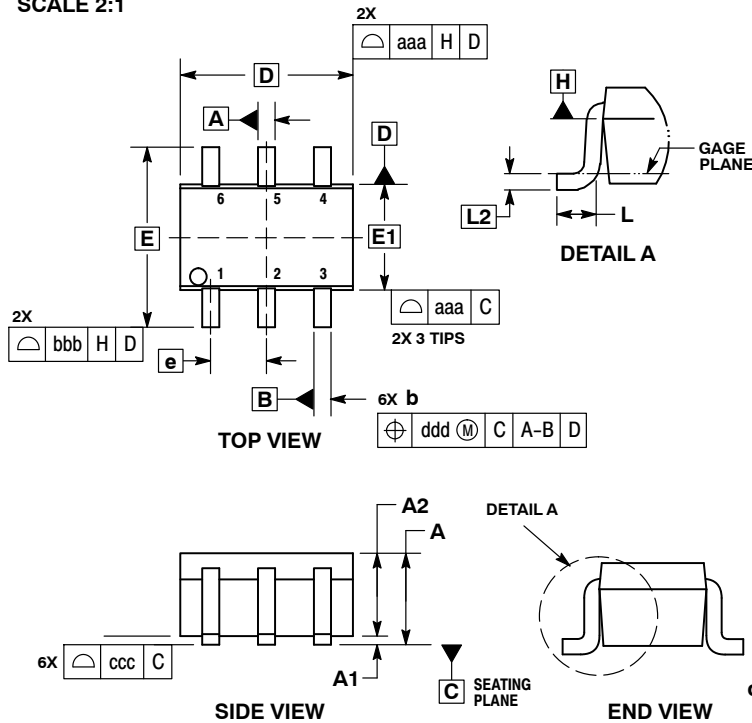

- NOTES:
1. DIMENSIONING AND TOLERANCING PER ASME Y14.5M, 1994.
  2. CONTROLLING DIMENSION: MILLIMETERS.
  3. DIMENSIONS D AND E1 DO NOT INCLUDE MOLD FLASH, PROTRUSIONS, OR GATE BURRS. MOLD FLASH, PROTRUSIONS, OR GATE BURRS SHALL NOT EXCEED 0.20 PER END.
  4. DIMENSIONS D AND E1 AT THE OUTERMOST EXTREMES OF THE PLASTIC BODY AND DATUM H.
  5. DATUMS A AND B ARE DETERMINED AT DATUM H.
  6. DIMENSIONS b AND c APPLY TO THE FLAT SECTION OF THE LEAD BETWEEN 0.08 AND 0.15 FROM THE TIP.
  7. DIMENSION b DOES NOT INCLUDE DAMBAR PROTRUSION. ALLOWABLE DAMBAR PROTRUSION SHALL BE 0.08 TOTAL IN EXCESS OF DIMENSION b AT MAXIMUM MATERIAL CONDITION. THE DAMBAR CANNOT BE LOCATED ON THE LOWER RADIUS OF THE FOOT.

DIM	MILLIMETERS			INCHES		
	MIN	NOM	MAX	MIN	NOM	MAX
A	---	---	1.10	---	---	0.043
A1	0.00	---	0.10	0.000	---	0.004
A2	0.70	0.90	1.00	0.027	0.035	0.039
b	0.15	0.20	0.25	0.006	0.008	0.010
C	0.08	0.15	0.22	0.003	0.006	0.009
D	1.80	2.00	2.20	0.070	0.078	0.086
E	2.00	2.10	2.20	0.078	0.082	0.086
E1	1.15	1.25	1.35	0.045	0.049	0.053
e	0.65 BSC			0.026 BSC		
L	0.26	0.36	0.46	0.010	0.014	0.018
L2	0.15 BSC			0.006 BSC		
aaa	0.15			0.006		
bbb	0.30			0.012		
ccc	0.10			0.004		
ddd	0.10			0.004		

### GENERIC MARKING DIAGRAM\*

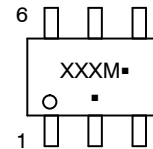

- XXX = Specific Device Code
- M = Date Code\*
- = Pb-Free Package

(Note: Microdot may be in either location)

\*Date Code orientation and/or position may vary depending upon manufacturing location.

\*This information is generic. Please refer to device data sheet for actual part marking. Pb-Free indicator, "G" or microdot "▪", may or may not be present. Some products may not follow the Generic Marking.

### RECOMMENDED SOLDERING FOOTPRINT\*

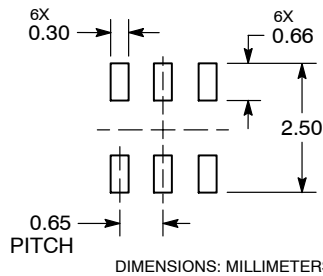

DIMENSIONS: MILLIMETERS

\*For additional information on our Pb-Free strategy and soldering details, please download the ON Semiconductor Soldering and Mounting Techniques Reference Manual, SOLDERRM/D.

### STYLES ON PAGE 2

DOCUMENT NUMBER:	98ASB42985B	Electronic versions are uncontrolled except when accessed directly from the Document Repository. Printed versions are uncontrolled except when stamped "CONTROLLED COPY" in red.
DESCRIPTION:	SC-88/SC70-6/SOT-363	PAGE 1 OF 2

ON Semiconductor and are trademarks of Semiconductor Components Industries, LLC dba ON Semiconductor or its subsidiaries in the United States and/or other countries. ON Semiconductor reserves the right to make changes without further notice to any products herein. ON Semiconductor makes no warranty, representation or guarantee regarding the suitability of its products for any particular purpose, nor does ON Semiconductor assume any liability arising out of the application or use of any product or circuit, and specifically disclaims any and all liability, including without limitation special, consequential or incidental damages. ON Semiconductor does not convey any license under its patent rights nor the rights of others.

**SC-88/SC70-6/SOT-363**  
**CASE 419B-02**  
**ISSUE Y**

DATE 11 DEC 2012

<b>STYLE 1:</b> PIN 1. EMITTER 2 2. BASE 2 3. COLLECTOR 1 4. EMITTER 1 5. BASE 1 6. COLLECTOR 2	<b>STYLE 2:</b> CANCELLED	<b>STYLE 3:</b> CANCELLED	<b>STYLE 4:</b> PIN 1. CATHODE 2. CATHODE 3. COLLECTOR 4. EMITTER 5. BASE 6. ANODE	<b>STYLE 5:</b> PIN 1. ANODE 2. ANODE 3. COLLECTOR 4. EMITTER 5. BASE 6. CATHODE	<b>STYLE 6:</b> PIN 1. ANODE 2 2. N/C 3. CATHODE 1 4. ANODE 1 5. N/C 6. CATHODE 2
<b>STYLE 7:</b> PIN 1. SOURCE 2 2. DRAIN 2 3. GATE 1 4. SOURCE 1 5. DRAIN 1 6. GATE 2	<b>STYLE 8:</b> CANCELLED	<b>STYLE 9:</b> PIN 1. EMITTER 2 2. EMITTER 1 3. COLLECTOR 1 4. BASE 1 5. BASE 2 6. COLLECTOR 2	<b>STYLE 10:</b> PIN 1. SOURCE 2 2. SOURCE 1 3. GATE 1 4. DRAIN 1 5. DRAIN 2 6. GATE 2	<b>STYLE 11:</b> PIN 1. CATHODE 2 2. CATHODE 2 3. ANODE 1 4. CATHODE 1 5. CATHODE 1 6. ANODE 2	<b>STYLE 12:</b> PIN 1. ANODE 2 2. ANODE 2 3. CATHODE 1 4. ANODE 1 5. ANODE 1 6. CATHODE 2
<b>STYLE 13:</b> PIN 1. ANODE 2. N/C 3. COLLECTOR 4. EMITTER 5. BASE 6. CATHODE	<b>STYLE 14:</b> PIN 1. VREF 2. GND 3. GND 4. IOUT 5. VEN 6. VCC	<b>STYLE 15:</b> PIN 1. ANODE 1 2. ANODE 2 3. ANODE 3 4. CATHODE 3 5. CATHODE 2 6. CATHODE 1	<b>STYLE 16:</b> PIN 1. BASE 1 2. EMITTER 2 3. COLLECTOR 2 4. BASE 2 5. EMITTER 1 6. COLLECTOR 1	<b>STYLE 17:</b> PIN 1. BASE 1 2. EMITTER 1 3. COLLECTOR 2 4. BASE 2 5. EMITTER 2 6. COLLECTOR 1	<b>STYLE 18:</b> PIN 1. VIN1 2. VCC 3. VOUT2 4. VIN2 5. GND 6. VOUT1
<b>STYLE 19:</b> PIN 1. IOUT 2. GND 3. GND 4. V CC 5. V EN 6. V REF	<b>STYLE 20:</b> PIN 1. COLLECTOR 2. COLLECTOR 3. BASE 4. EMITTER 5. COLLECTOR 6. COLLECTOR	<b>STYLE 21:</b> PIN 1. ANODE 1 2. N/C 3. ANODE 2 4. CATHODE 2 5. N/C 6. CATHODE 1	<b>STYLE 22:</b> PIN 1. D1 (i) 2. GND 3. D2 (i) 4. D2 (c) 5. VBUS 6. D1 (c)	<b>STYLE 23:</b> PIN 1. Vn 2. CH1 3. Vp 4. N/C 5. CH2 6. N/C	<b>STYLE 24:</b> PIN 1. CATHODE 2. ANODE 3. CATHODE 4. CATHODE 5. CATHODE 6. CATHODE
<b>STYLE 25:</b> PIN 1. BASE 1 2. CATHODE 3. COLLECTOR 2 4. BASE 2 5. EMITTER 6. COLLECTOR 1	<b>STYLE 26:</b> PIN 1. SOURCE 1 2. GATE 1 3. DRAIN 2 4. SOURCE 2 5. GATE 2 6. DRAIN 1	<b>STYLE 27:</b> PIN 1. BASE 2 2. BASE 1 3. COLLECTOR 1 4. EMITTER 1 5. EMITTER 2 6. COLLECTOR 2	<b>STYLE 28:</b> PIN 1. DRAIN 2. DRAIN 3. GATE 4. SOURCE 5. DRAIN 6. DRAIN	<b>STYLE 29:</b> PIN 1. ANODE 2. ANODE 3. COLLECTOR 4. EMITTER 5. BASE/ANODE 6. CATHODE	<b>STYLE 30:</b> PIN 1. SOURCE 1 2. DRAIN 2 3. DRAIN 2 4. SOURCE 2 5. GATE 1 6. DRAIN 1

Note: Please refer to datasheet for style callout. If style type is not called out in the datasheet refer to the device datasheet pinout or pin assignment.

<b>DOCUMENT NUMBER:</b>	<b>98ASB42985B</b>	Electronic versions are uncontrolled except when accessed directly from the Document Repository. Printed versions are uncontrolled except when stamped "CONTROLLED COPY" in red.
<b>DESCRIPTION:</b>	<b>SC-88/SC70-6/SOT-363</b>	<b>PAGE 2 OF 2</b>

ON Semiconductor and  are trademarks of Semiconductor Components Industries, LLC dba ON Semiconductor or its subsidiaries in the United States and/or other countries. ON Semiconductor reserves the right to make changes without further notice to any products herein. ON Semiconductor makes no warranty, representation or guarantee regarding the suitability of its products for any particular purpose, nor does ON Semiconductor assume any liability arising out of the application or use of any product or circuit, and specifically disclaims any and all liability, including without limitation special, consequential or incidental damages. ON Semiconductor does not convey any license under its patent rights nor the rights of others.

**onsemi**, **Onsemi**, and other names, marks, and brands are registered and/or common law trademarks of Semiconductor Components Industries, LLC dba "**onsemi**" or its affiliates and/or subsidiaries in the United States and/or other countries. **onsemi** owns the rights to a number of patents, trademarks, copyrights, trade secrets, and other intellectual property. A listing of **onsemi**'s product/patent coverage may be accessed at [www.onsemi.com/site/pdf/Patent-Marking.pdf](http://www.onsemi.com/site/pdf/Patent-Marking.pdf). **onsemi** reserves the right to make changes at any time to any products or information herein, without notice. The information herein is provided "as-is" and **onsemi** makes no warranty, representation or guarantee regarding the accuracy of the information, product features, availability, functionality, or suitability of its products for any particular purpose, nor does **onsemi** assume any liability arising out of the application or use of any product or circuit, and specifically disclaims any and all liability, including without limitation special, consequential or incidental damages. Buyer is responsible for its products and applications using **onsemi** products, including compliance with all laws, regulations and safety requirements or standards, regardless of any support or applications information provided by **onsemi**. "Typical" parameters which may be provided in **onsemi** data sheets and/or specifications can and do vary in different applications and actual performance may vary over time. All operating parameters, including "Typicals" must be validated for each customer application by customer's technical experts. **onsemi** does not convey any license under any of its intellectual property rights nor the rights of others. **onsemi** products are not designed, intended, or authorized for use as a critical component in life support systems or any FDA Class 3 medical devices or medical devices with a same or similar classification in a foreign jurisdiction or any devices intended for implantation in the human body. Should Buyer purchase or use **onsemi** products for any such unintended or unauthorized application, Buyer shall indemnify and hold **onsemi** and its officers, employees, subsidiaries, affiliates, and distributors harmless against all claims, costs, damages, and expenses, and reasonable attorney fees arising out of, directly or indirectly, any claim of personal injury or death associated with such unintended or unauthorized use, even if such claim alleges that **onsemi** was negligent regarding the design or manufacture of the part. **onsemi** is an Equal Opportunity/Affirmative Action Employer. This literature is subject to all applicable copyright laws and is not for resale in any manner.

## PUBLICATION ORDERING INFORMATION

### LITERATURE FULFILLMENT:

Email Requests to: [orderlit@onsemi.com](mailto:orderlit@onsemi.com)

**onsemi Website:** [www.onsemi.com](http://www.onsemi.com)

### TECHNICAL SUPPORT

**North American Technical Support:**

Voice Mail: 1 800-282-9855 Toll Free USA/Canada

Phone: 011 421 33 790 2910

**Europe, Middle East and Africa Technical Support:**

Phone: 00421 33 790 2910

For additional information, please contact your local Sales Representative

