

ON Semiconductor

Is Now

onsemi™

To learn more about onsemi™, please visit our website at
www.onsemi.com

onsemi and **onsemi** and other names, marks, and brands are registered and/or common law trademarks of Semiconductor Components Industries, LLC dba "**onsemi**" or its affiliates and/or subsidiaries in the United States and/or other countries. **onsemi** owns the rights to a number of patents, trademarks, copyrights, trade secrets, and other intellectual property. A listing of **onsemi** product/patent coverage may be accessed at www.onsemi.com/site/pdf/Patent-Marking.pdf. **onsemi** reserves the right to make changes at any time to any products or information herein, without notice. The information herein is provided "as-is" and **onsemi** makes no warranty, representation or guarantee regarding the accuracy of the information, product features, availability, functionality, or suitability of its products for any particular purpose, nor does **onsemi** assume any liability arising out of the application or use of any product or circuit, and specifically disclaims any and all liability, including without limitation special, consequential or incidental damages. Buyer is responsible for its products and applications using **onsemi** products, including compliance with all laws, regulations and safety requirements or standards, regardless of any support or applications information provided by **onsemi**. "Typical" parameters which may be provided in **onsemi** data sheets and/or specifications can and do vary in different applications and actual performance may vary over time. All operating parameters, including "Typicals" must be validated for each customer application by customer's technical experts. **onsemi** does not convey any license under any of its intellectual property rights nor the rights of others. **onsemi** products are not designed, intended, or authorized for use as a critical component in life support systems or any FDA Class 3 medical devices or medical devices with a same or similar classification in a foreign jurisdiction or any devices intended for implantation in the human body. Should Buyer purchase or use **onsemi** products for any such unintended or unauthorized application, Buyer shall indemnify and hold **onsemi** and its officers, employees, subsidiaries, affiliates, and distributors harmless against all claims, costs, damages, and expenses, and reasonable attorney fees arising out of, directly or indirectly, any claim of personal injury or death associated with such unintended or unauthorized use, even if such claim alleges that **onsemi** was negligent regarding the design or manufacture of the part. **onsemi** is an Equal Opportunity/Affirmative Action Employer. This literature is subject to all applicable copyright laws and is not for resale in any manner. Other names and brands may be claimed as the property of others.



Is Now Part of



ON Semiconductor®

To learn more about ON Semiconductor, please visit our website at
www.onsemi.com

Please note: As part of the Fairchild Semiconductor integration, some of the Fairchild orderable part numbers will need to change in order to meet ON Semiconductor's system requirements. Since the ON Semiconductor product management systems do not have the ability to manage part nomenclature that utilizes an underscore (_), the underscore (_) in the Fairchild part numbers will be changed to a dash (-). This document may contain device numbers with an underscore (_). Please check the ON Semiconductor website to verify the updated device numbers. The most current and up-to-date ordering information can be found at www.onsemi.com. Please email any questions regarding the system integration to Fairchild_questions@onsemi.com.

ON Semiconductor and the ON Semiconductor logo are trademarks of Semiconductor Components Industries, LLC dba ON Semiconductor or its subsidiaries in the United States and/or other countries. ON Semiconductor owns the rights to a number of patents, trademarks, copyrights, trade secrets, and other intellectual property. A listing of ON Semiconductor's product/patent coverage may be accessed at www.onsemi.com/site/pdf/Patent-Marking.pdf. ON Semiconductor reserves the right to make changes without further notice to any products herein. ON Semiconductor makes no warranty, representation or guarantee regarding the suitability of its products for any particular purpose, nor does ON Semiconductor assume any liability arising out of the application or use of any product or circuit, and specifically disclaims any and all liability, including without limitation special, consequential or incidental damages. Buyer is responsible for its products and applications using ON Semiconductor products, including compliance with all laws, regulations and safety requirements or standards, regardless of any support or applications information provided by ON Semiconductor. "Typical" parameters which may be provided in ON Semiconductor data sheets and/or specifications can and do vary in different applications and actual performance may vary over time. All operating parameters, including "Typicals" must be validated for each customer application by customer's technical experts. ON Semiconductor does not convey any license under its patent rights nor the rights of others. ON Semiconductor products are not designed, intended, or authorized for use as a critical component in life support systems or any FDA Class 3 medical devices or medical devices with a same or similar classification in a foreign jurisdiction or any devices intended for implantation in the human body. Should Buyer purchase or use ON Semiconductor products for any such unintended or unauthorized application, Buyer shall indemnify and hold ON Semiconductor and its officers, employees, subsidiaries, affiliates, and distributors harmless against all claims, costs, damages, and expenses, and reasonable attorney fees arising out of, directly or indirectly, any claim of personal injury or death associated with such unintended or unauthorized use, even if such claim alleges that ON Semiconductor was negligent regarding the design or manufacture of the part. ON Semiconductor is an Equal Opportunity/Affirmative Action Employer. This literature is subject to all applicable copyright laws and is not for resale in any manner.



July 2014

FAN53540

2.4 MHz, 5 A TinyBuck™ Synchronous Buck Regulator

Features

- 2.4 MHz Fixed-Frequency Operation
- Best-in-Class Load Transient Response
- 5 A Output Current Capability
- 2.7 V to 5.5 V Input Voltage Range
- Adjustable Output Voltage: 0.8V to 90% of V_{IN}
- PFM Mode for High Efficiency in Light Load (Forced PWM Available on MODE Pin)
- 50 μ A Typical Quiescent Current in PFM Mode
- External Frequency Synchronization
- Low Ripple Light-Load PFM Mode with Forced PWM Control
- Power Good Output
- Internal Soft-Start
- Input Under-Voltage Lockout (UVLO)
- Thermal Shutdown and Overload Protection
- No External Compensation Required
- 20-Bump WLCSP

Applications

- Set-Top Box
- Hard Disk Drive
- Communications Cards
- DSP Power

Description

The FAN53540 is a step-down switching voltage regulator that delivers an adjustable output from an input voltage supply of 2.7 V to 5.5 V. Using a proprietary architecture with synchronous rectification, the FAN53540 is capable of delivering 5 A at over 90% efficiency, while maintaining a very high efficiency of over 80% at load currents as low as 2 mA. The regulator operates at a nominal fixed frequency of 2.4 MHz, which reduces the value of the external components to 470 nH for the output inductor and 20 μ F for the output capacitor. Additional output capacitance can be added to improve regulation during load transients without affecting stability and inductance up to 1.2 μ H may be used with additional output capacitance.

At moderate and light loads, pulse frequency modulation (PFM) is used to operate the device in power-save mode with a typical quiescent current of 50 μ A. Even with such a low quiescent current, the part exhibits excellent transient response during large load swings. At higher loads, the system automatically switches to fixed-frequency supply control, operating at 2.4 MHz. In shutdown mode, the supply current drops below 1 μ A, reducing power consumption. PFM mode can be disabled if constant frequency is desired. The FAN53540 is available in a 20-bump 1.96 mm x 1.56 mm Wafer-Level Chip-Scale Package (WLCSP).

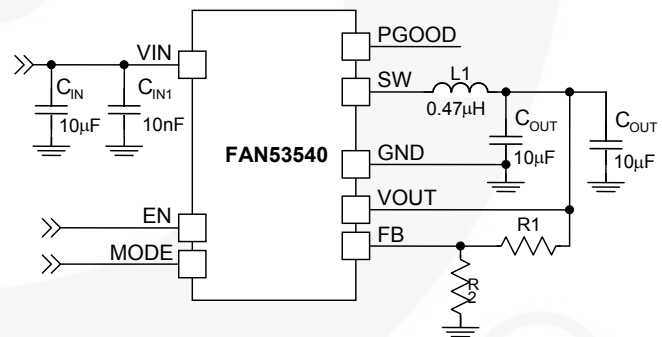
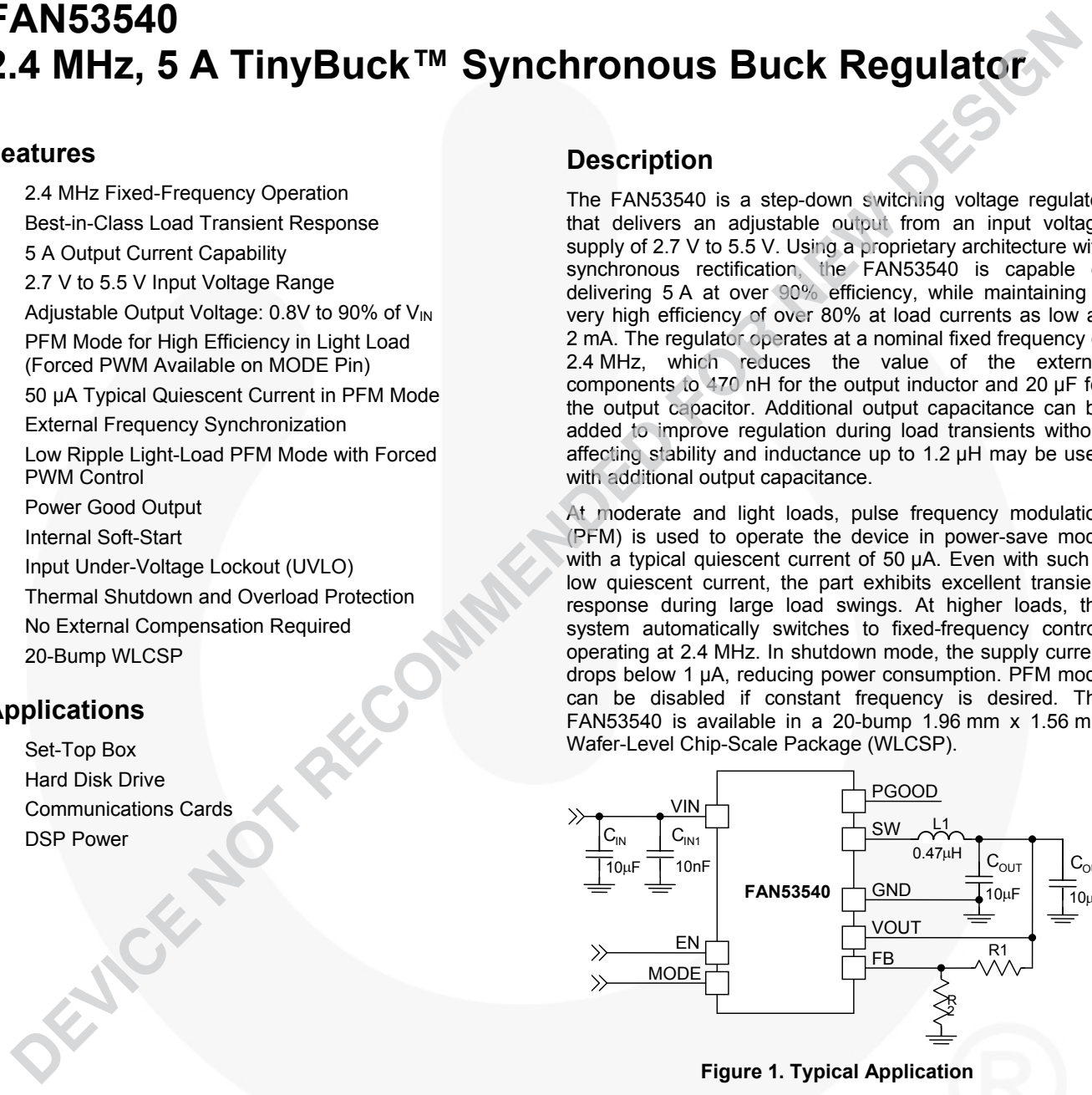

Figure 1. Typical Application

Ordering Information

Part Number	Temperature Range	Package	Packing Method
FAN53540UCX	-40 to 85°C	20-Ball Wafer-Level, Chip-Scale Package (WLCSP), 4x5 Array, 0.4 mm Pitch, 250 μ m Ball	Tape and Reel



Recommended External Components

Table 1. Recommended External Components for 5 A Maximum Load Current

Component	Description	Vendor	Parameter	Typical	Unit
L1	470 nH Nominal	See Table 2	L	0.47	μH
C _{OUT}	10 μF, 6.3 V, X5R, 0805, 2 Pieces	GRM21BR60J106M (Murata) C2012X5R0J106M (TDK)	C	10	μF
C _{IN}	10 μF, 6.3 V, X5R, 0805				
C _{IN1}	10 nF, 25 V, X7R, 0402	Any	C	10	nF

Table 2. Recommended Inductors

Manufacturer	Part#	L (nH)	DCR (mΩ)	I _{MAXDC} ⁽¹⁾	Component Dimensions		
					L	W	H
Bourns	SRP5012-R47M	470	19	6.0	5.1	4.5	1.2
Bourns	SRP4012-R47M	470	20	5.5	4.6	4.0	1.2
Coilcraft	XPL4020-471ML	470	19	7.2	4.2	4.2	2.0
Inter-Technical ⁽²⁾	SC2511-R47M	470	2.6	16.0	6.5	6.5	3.0
TDK	VLC5020T-R47M	470	15	5.4	5.0	5.0	2.0
Vishay	IHLP1616ABERR47M01	470	20	5.0	4.5	4.1	1.2

Notes:

1. I_{MAXDC} is the lesser current to produce 40°C temperature rise or 30% inductance roll-off.
2. Inductor used for efficiency and temperature rise measurements.

Pin Configuration

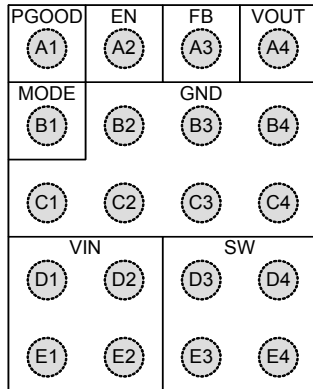

Figure 2. Top View

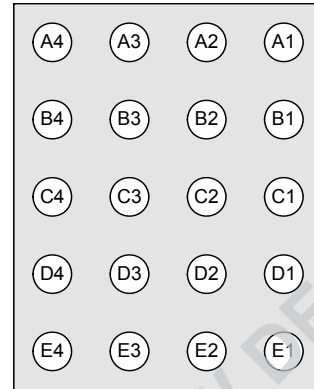

Figure 3. Top View Bottom View

Pin Definitions

Bump #	Name	Description
A1	PGOOD	Power Good. This open-drain pin pulls LOW if the output falls out of regulation or is in soft-start.
A2	EN	Enable. The device is in Shutdown Mode when this pin is LOW. Do not leave this pin floating. When tying HIGH, use at least a 1 kΩ series resistor if V_{IN} is expected to exceed 4.5 V.
A3	FB	FB. Connect to resistor divider. The IC regulates this pin to 0.8 V.
A4	VOUT	VOUT. Sense pin for V_{OUT} . Connect directly to C_{OUT} .
B1	MODE	MODE / SYNC. A logic 0 allows the IC to automatically switch to PFM during light loads. When held HIGH, the IC to stays in PWM Mode. The regulator also synchronizes its switching frequency to four times (4X) the frequency provided on this pin (f_{MODE}). Do not leave this pin floating. When tying HIGH, use at least a 1 kΩ series resistor if V_{IN} is expected to exceed 4.5 V.
B2, B3, C1 – C4	GND	Ground. Low-side MOSFET is referenced to this pin. C_{IN} and C_{OUT} should be returned with a minimal path to these pins.
B4	AGND	Analog Ground. All signals are referenced to this pin. Avoid routing high dV/dt AC currents through this pin.
D1, D2, E1, E2	VIN	Power Input Voltage. Connect to input power source. Connect to C_{IN} with minimal path.
D3, D4, E3, E4	SW	Switching Node. Connect to inductor.

Absolute Maximum Ratings

Stresses exceeding the absolute maximum ratings may damage the device. The device may not function or be operable above the recommended operating conditions and stressing the parts to these levels is not recommended. In addition, extended exposure to stresses above the recommended operating conditions may affect device reliability. The absolute maximum ratings are stress ratings only.

Symbol	Parameter		Min.	Max.	Unit
V_{IN}	SW, VIN Pins		-0.3	7.0 ⁽³⁾	V
	Other Pins	Tied without Series Impedance	-0.3	4.5	
		Tied through Series Resistance $\geq 100 \Omega$	-0.3	V_{IN}	
ESD	Electrostatic Discharge Protection Level	Human Body Model per JESD22-A114	2250		V
		Charged Device Model per JESD22-C101	1500		
T_J	Junction Temperature		-40	+150	°C
T_{STG}	Storage Temperature		-65	+150	°C
T_L	Lead Soldering Temperature, 10 Seconds			+260	°C

Note:

- V_{IN} slew rate is limited to 1 V/ μ s.
- Lesser of 7 V or $V_{IN}+0.3$ V.

Recommended Operating Conditions

The Recommended Operating Conditions table defines the conditions for actual device operation. Recommended operating conditions are specified to ensure optimal performance to the datasheet specifications. Fairchild does not recommend exceeding them or designing to Absolute Maximum Ratings.

Symbol	Parameter	Min.	Typ.	Max.	Unit
V_{IN}	Supply Voltage Range	2.7		5.5	V
V_{OUT}	Output Voltage Range	0.8		90% Duty Cycle	V
I_{OUT}	Output Current	0		5	A
L	Inductor		0.47	1.20	μ H
C_{IN}	Input Capacitor		10		μ F
C_{OUT}	Output Capacitor		20		μ F
T_A	Operating Ambient Temperature	-40		+85	°C
T_J	Operating Junction Temperature	-40		+125	°C

Thermal Properties

Symbol	Parameter	Typical	Unit
θ_{JA}	Junction-to-Ambient Thermal Resistance	38 ⁽⁵⁾	°C/W

Note:

- See *Thermal Considerations in the Applications* section.

Electrical Characteristics

Minimum and maximum values are at $V_{IN}=2.7\text{ V}$ to 5.5 V , and $T_A=-40^\circ\text{C}$ to $+85^\circ\text{C}$, unless otherwise noted. Typical values are at $T_A=25^\circ\text{C}$, $V_{IN}=5\text{ V}$, and $V_{OUT}=1.2\text{ V}$.

Symbol	Parameter	Condition	Min.	Typ.	Max.	Unit
Power Supplies						
I_Q	Quiescent Current	$I_{LOAD}=0$, MODE=0 (AUTO PFM/PWM)		50		μA
		$I_{LOAD}=0$, MODE=1 (Forced PWM)		30		mA
I_{SD}	Shutdown Supply Current	EN=GND		0.1	10.0	μA
V_{UVLO}	Under-Voltage Lockout Threshold	V_{IN} Rising		2.67	2.80	V
		V_{IN} Falling	2.1	2.3		V
V_{UVHYST}	Under-Voltage Lockout Hysteresis			365		mV
Logic Pins						
V_{IH}	High-Level Input Voltage		1.05			V
V_{IL}	Low-Level Input Voltage				0.4	V
V_{LHYST}	Logic Input Hysteresis Voltage			140		mV
I_{IN}	Input Bias Current	Input Tied to GND or 1 k Ω Resistor to V_{IN}		0.01	1.00	μA
I_{OUTL}	PGOOD Pull-Down Current	$V_{PGOOD}=0.4\text{ V}$	1			mA
I_{OUTH}	PGOOD HIGH Leakage Current	$V_{PGOOD}=V_{IN}$		0.01	1.00	μA
V_{OUT} Regulation						
V_{REF}	Output Reference DC Accuracy, Measured at FB Pin	$T_A=25^\circ\text{C}$, Forced PWM	0.792	0.800	0.808	V
		$T_A=-40^\circ\text{C}$ to 85°C , Forced PWM	0.787	0.800	0.813	V
		AUTO PFM/PWM	0.784	0.800	0.824	V
$\frac{\Delta V_{OUT}}{\Delta I_{LOAD}}$	Load Regulation	MODE= V_{IN} (Forced PWM)		-0.02		%/A
$\frac{\Delta V_{OUT}}{\Delta V_{IN}}$	Line Regulation	$2.7\text{ V} \leq V_{IN} \leq 5.5\text{ V}$, $I_{OUT(DC)}=1.5\text{ A}$		-0.16		%/V
I_{REF}	FB Pin Leakage Current	FB=0.8 V		1		nA
ΔV_{OUT}	Transient Response	I_{LOAD} Step 0.1 A to 1.5 A, $t_R=100\text{ ns}$		-30		mV
Power Switch and Protection						
$R_{DS(ON)P}$	P-Channel MOSFET On Resistance			33		$\text{m}\Omega$
$R_{DS(ON)N}$	N-Channel MOSFET On Resistance			28		$\text{m}\Omega$
I_{LIMPK}	P-MOS Peak Current Limit	Open Loop	5.8	7.5	8.8	A
		Closed Loop		8		A
T_{LIMIT}	Thermal Shutdown			155		$^\circ\text{C}$
T_{HYST}	Thermal Shutdown Hysteresis			20		$^\circ\text{C}$
V_{SDWN}	Input OVP Shutdown	Rising Threshold		6.1		V
		Falling Threshold	5.5	5.8		V
Frequency Control						
f_{SM}	Oscillator Frequency		2.1	2.4	3.0	MHz
f_{MODE}	MODE Pin Synchronization Range	External Square-Wave, 30% to 70% Duty Cycle	525	600	700	kHz
Soft-Start and Output Discharge						
t_{SS}	Regulator Enable to Regulated V_{OUT} (Rising PGOOD)			1.2		ms
R_{DIS}	Output Discharge Resistance	EN=0 V		175		Ω

Typical Characteristics

Unless otherwise specified; $V_{IN}=5\text{ V}$, $V_{OUT}=1.2\text{ V}$, $V_{MODE}=0\text{ V}$, $T_A=25^\circ\text{C}$, circuit in Figure 1, and components per Table 1.

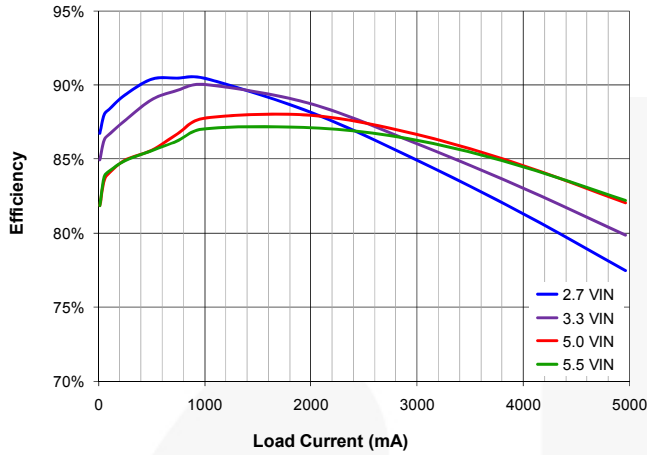

Figure 4. Efficiency vs. I_{LOAD} , 1.2 V_{OUT}

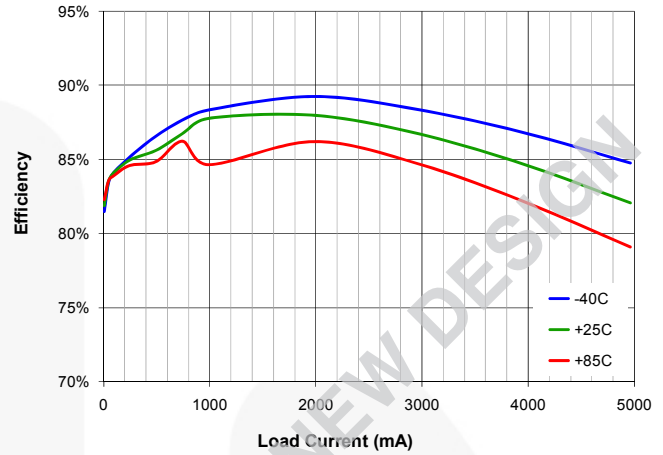

Figure 5. Efficiency vs. I_{LOAD} , 1.2 V_{OUT}

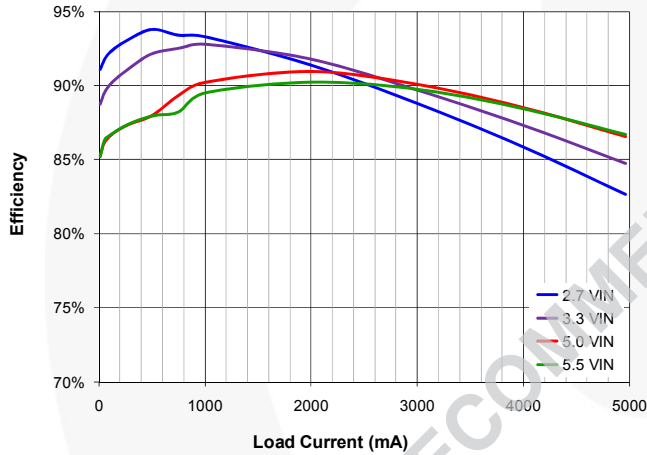

Figure 6. Efficiency vs. I_{LOAD} , 1.8 V_{OUT}

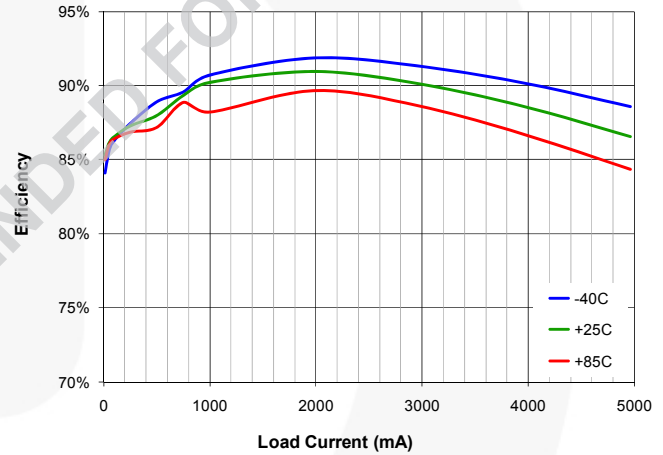

Figure 7. Efficiency vs. I_{LOAD} , 1.8 V_{OUT}

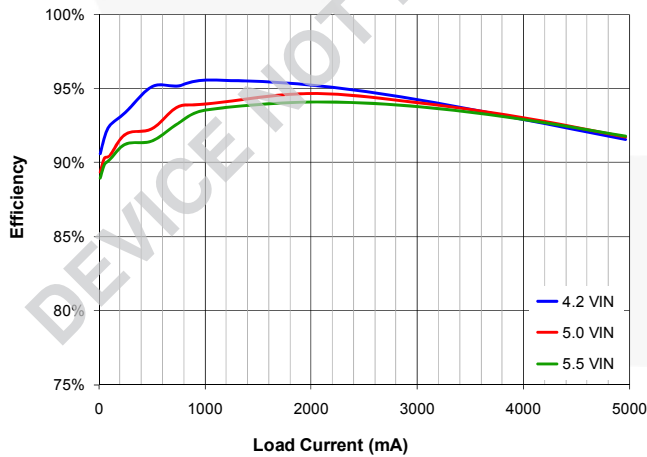

Figure 8. Efficiency vs. I_{LOAD} , 3.3 V_{OUT}

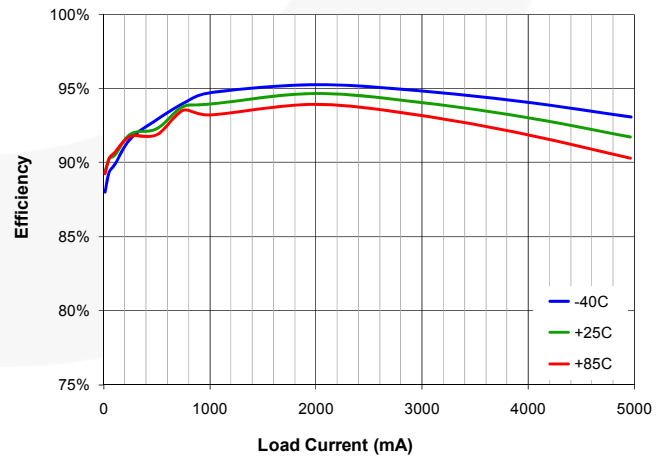

Figure 9. Efficiency vs. I_{LOAD} , 3.3 V_{OUT}

Typical Characteristics

Unless otherwise specified; $V_{IN}=5\text{ V}$, $V_{OUT}=1.2\text{ V}$, $V_{MODE}=0\text{ V}$, $T_A=25^\circ\text{C}$, circuit in Figure 1, and components per Table 1.

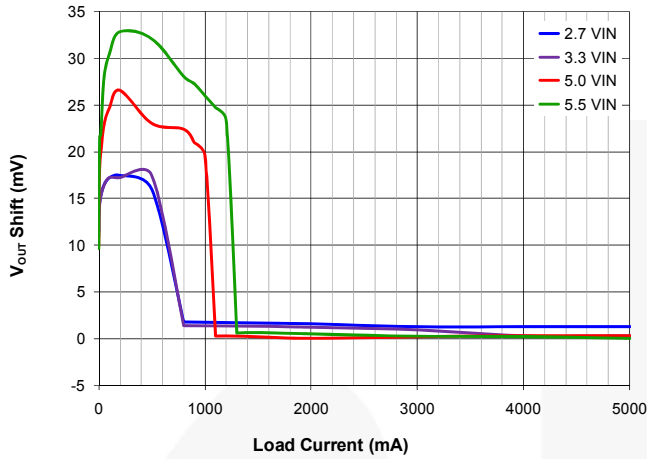

Figure 10. Regulation, 1.2 V_{OUT}

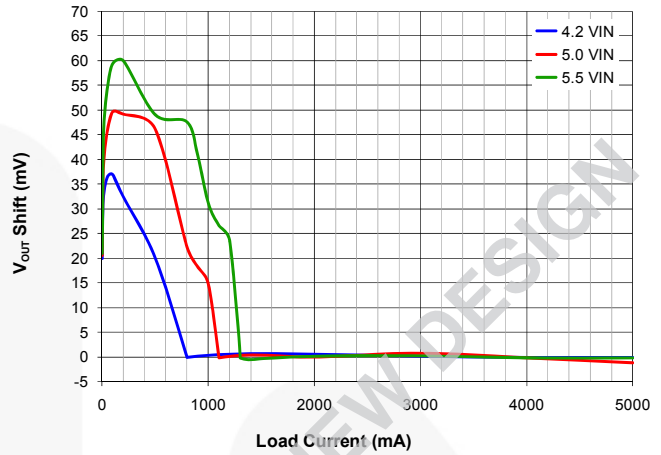

Figure 11. Regulation, 3.3 V_{OUT}

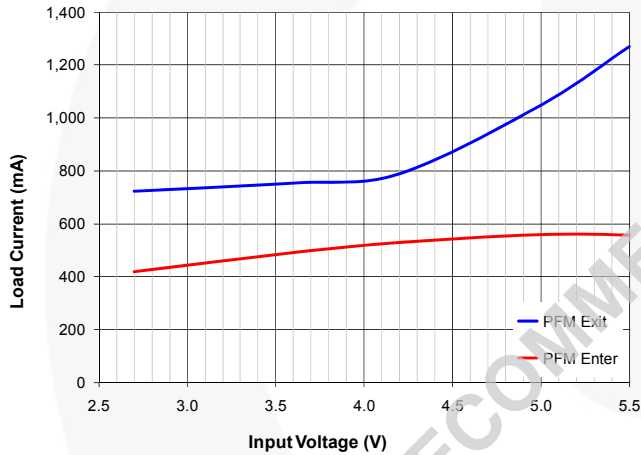

Figure 12. PFM / PWM Boundaries, 1.2 V_{OUT}

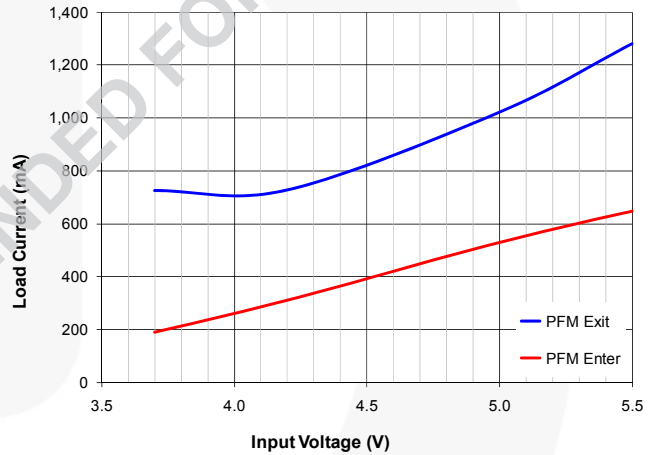

Figure 13. PFM / PWM Boundaries, 3.3 V_{OUT}

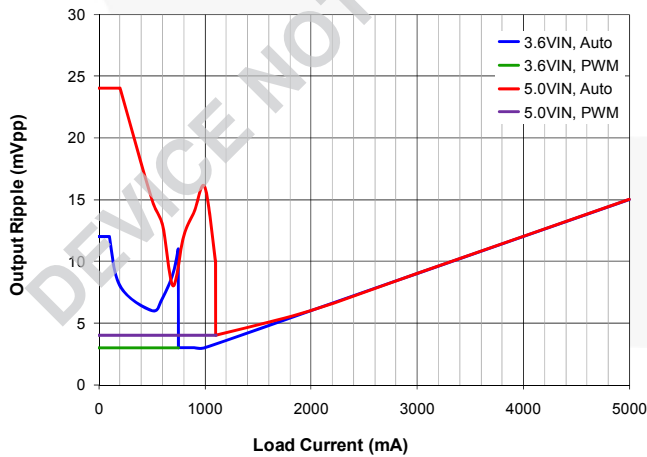

Figure 14. Output Voltage Ripple

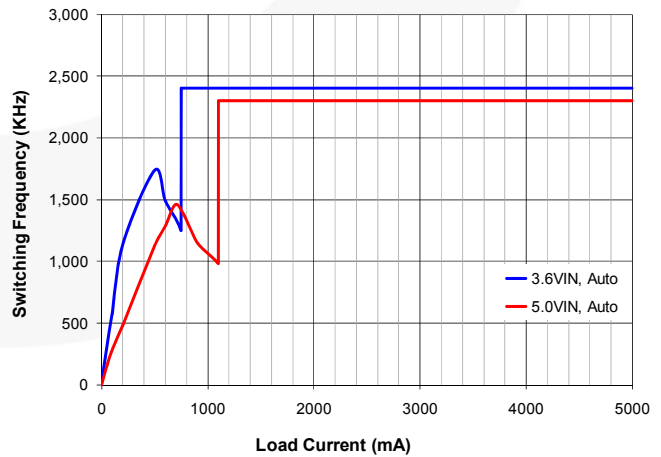

Figure 15. Switching Frequency

Typical Characteristics

Unless otherwise specified; $V_{IN}=5\text{ V}$, $V_{OUT}=1.2\text{ V}$, $V_{MODE}=0\text{ V}$, $T_A=25^\circ\text{C}$, circuit in Figure 1, and components per Table 1.

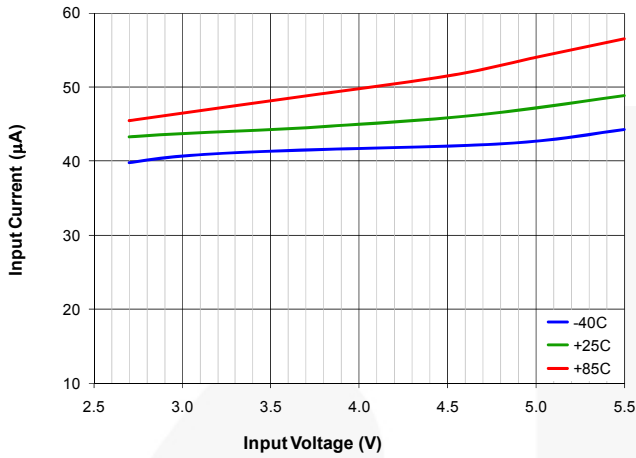

Figure 16. Quiescent Current, Auto Mode, $EN=V_{IN}$

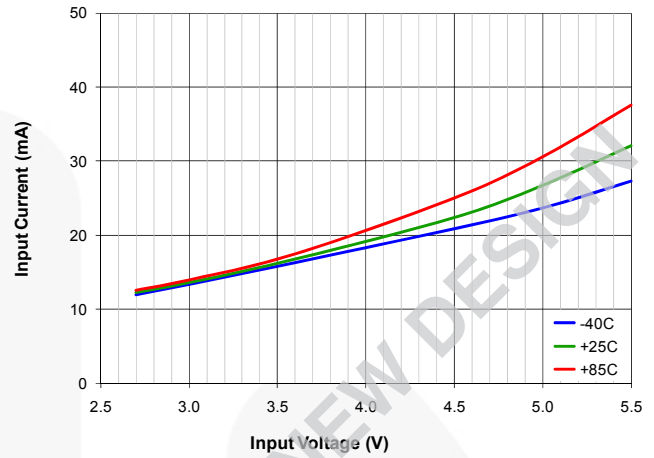

Figure 17. Quiescent Current, PMW Mode, $EN=V_{IN}$

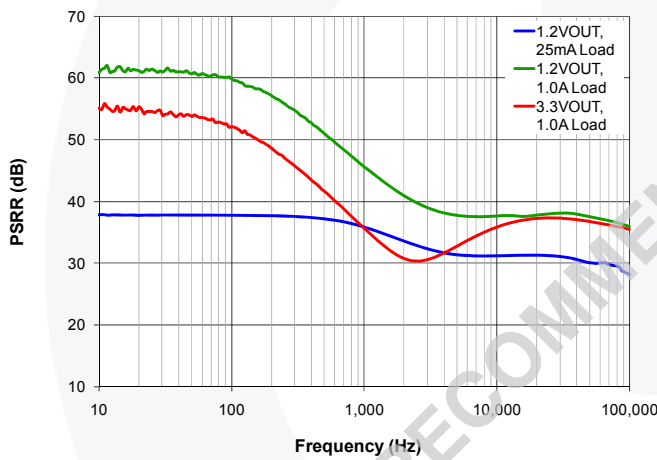

Figure 18. Power Supply Rejection (PSRR)

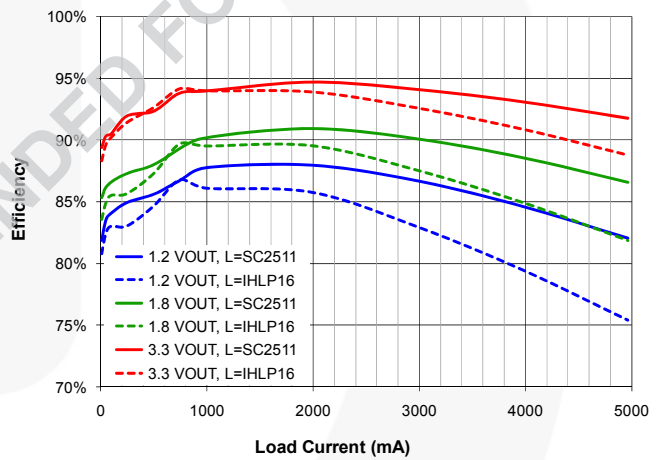

Figure 19. Inductor Efficiency Comparison, 5.0 V_{IN}



Figure 20. Line Transient, $50\ \Omega$ Load, $t_R=t_F=10\ \mu\text{s}$



Figure 21. Line Transient, $I_{LOAD}=1.0\text{ A}$, $t_R=t_F=10\ \mu\text{s}$

Typical Characteristics

Unless otherwise specified; $V_{IN}=5\text{ V}$, $V_{OUT}=1.2\text{ V}$, $V_{MODE}=0\text{ V}$, $T_A=25^\circ\text{C}$, circuit in Figure 1, and components per Table 1.

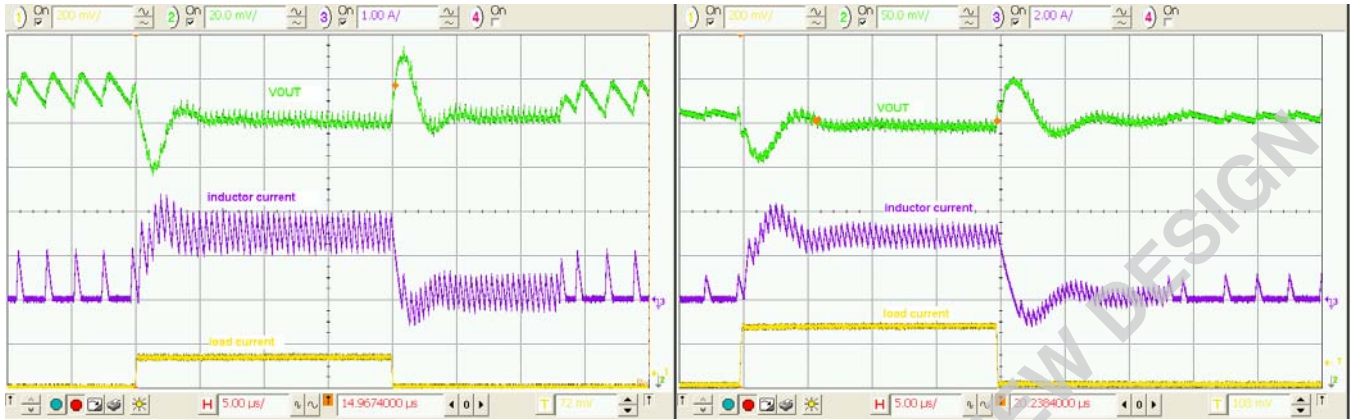

Figure 22. Load Transient, 0.1-1.5 A Load,
 $t_R=t_F=100\text{ ns}$

Figure 23. Load Transient, 0.1-3.0 A Load,
 $t_R=t_F=100\text{ ns}$, $C_{OUT}=2\times 22\ \mu\text{F}$



Figure 24. Startup / Shutdown, No Load

Figure 25. Startup / Shutdown, 240 mΩ Load,
 $C_{OUT}=2\times 22\ \mu\text{F}$

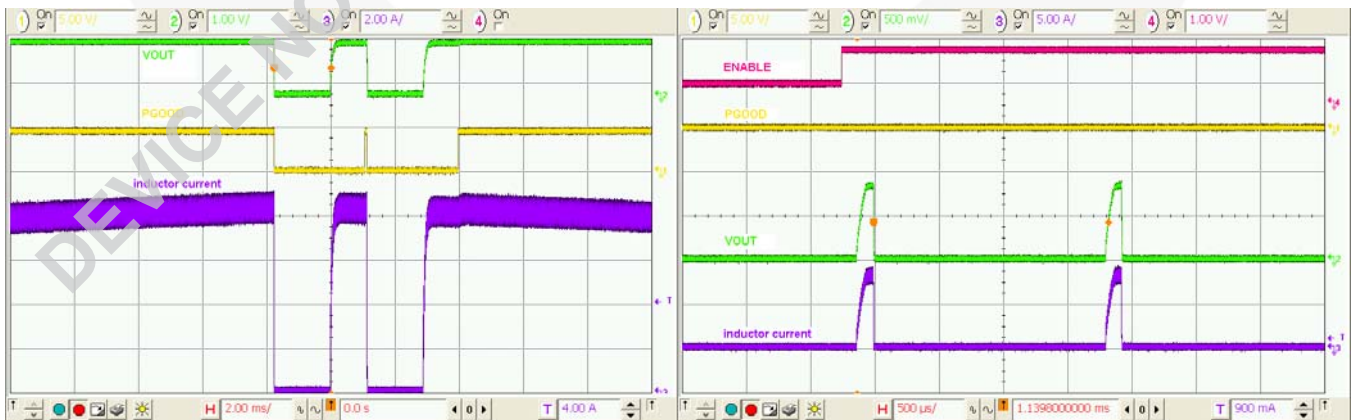

Figure 26. Overload Protection and Recovery

Figure 27. Startup into Overload

Operation Description

The FAN53540 is a step-down switching voltage regulator that delivers an adjustable output from an input voltage supply of 2.7 V to 5.5 V. Using a proprietary architecture with synchronous rectification, the FAN53540 is capable of delivering up to 5 A at over 90% efficiency. The regulator operates at a nominal frequency of 2.4 MHz at full load, which reduces the value of the external components to 470 nH for the output inductor and 20 μ F for the output capacitor. High efficiency is maintained at light load with single-pulse PFM Mode.

Control Scheme

The FAN53540 uses a proprietary non-linear, fixed-frequency PWM modulator to deliver very fast load transient response, while maintaining a constant switching frequency over a wide range of operating conditions.

Regulator performance is independent of the output capacitor ESR, allowing for the use of ceramic output capacitors. Although this type of operation normally results in a switching frequency that varies with input voltage and load current, an internal frequency loop holds the switching frequency constant over a large range of input voltages and load currents.

For very light loads, the FAN53540 operates in Discontinuous Current (DCM) single-pulse PFM Mode, which produces low output ripple compared with other PFM architectures. Transition between PWM and PFM is seamless, with a glitch of less than 3% of V_{OUT} during the transition between DCM and CCM Modes.

PFM Mode is disabled by holding the MODE pin HIGH. The IC synchronizes to the MODE pin frequency. When synchronizing to the MODE pin, PFM Mode is disabled.

Setting Output Voltage

The output voltage is set by the R1, R2, and V_{REF} (0.8 V):

$$\frac{R1}{R2} = \frac{V_{OUT} - V_{REF}}{V_{REF}} \quad (1)$$

R1 must be set at or below 100 k Ω ; therefore:

$$R2 = \frac{R1 \cdot 0.8}{(V_{OUT} - 0.8)} \quad (2)$$

For example, for $V_{OUT} = 1.2$ V, $R1 = 100$ k Ω , $R2 = 200$ k Ω .

Enable and Soft-Start

When the EN pin is LOW, the IC is shut down, all internal circuits are off, and the part draws very little current. Raising EN above its threshold voltage activates the part and starts the soft-start cycle. During soft-start, the modulator's internal reference is ramped slowly to minimize surge currents on the input and prevents overshoot of the output voltage.

If large values of output capacitance are used, the regulator may fail to start. If V_{OUT} fails to achieve regulation within 1.2 ms from the beginning of soft-start, the regulator shuts down and waits 1.6 ms before attempting a restart. If the regulator is in current limit for 16 consecutive PWM cycles, the regulator shuts down before restarting 1.6 ms later. This

limits the C_{OUT} capacitance when a heavy load ($I_{LOAD(SS)}$) is applied during the startup.

The maximum C_{OUT} capacitance for successful starting with a heavy constant-current load is approximately:

$$C_{OUT\ MAX} \approx (5.8 - I_{LOAD}) \cdot \frac{800}{V_{OUT}} \quad (3)$$

where $C_{OUT\ MAX}$ is expressed in μ F and I_{LOAD} is the load current during soft-start, expressed in A.

Diode Emulation Mode is employed during soft-start, allowing the IC to start into a pre-charged output. Diode emulation prohibits reverse inductor current from flowing through the synchronous rectifier.

When EN is LOW, a 150 Ω resistor discharges V_{OUT} .

Under-Voltage Lockout (UVLO)

When EN is HIGH, the under-voltage lockout keeps the part from operating until the input supply voltage rises high enough to operate properly. This ensures no misbehavior of the regulator during startup or shutdown.

Input Over-Voltage Protection (OVP)

When V_{IN} exceeds V_{SDWN} (about 6.1 V), the IC stops switching to protect the circuitry from excessive internal voltage spikes. An internal filter prevents the circuit from shutting down due to V_{IN} noise spikes.

Current Limiting

A heavy load or short circuit on the output causes the current in the inductor to increase until a maximum current threshold is reached in the high-side switch. Upon reaching this point, the high-side switch turns off, preventing high currents from causing damage. 16 consecutive PWM cycles in current limit cause the regulator to shut down and stay off for about 1.6 ms before attempting a restart.

In the event of a short circuit, the soft-start circuit attempts to restart and produces an over-current fault after 16 consecutive cycles in current limit, which results in a duty cycle of less than 5%, providing current into a short circuit.

External Frequency Synchronization

Logic 1 on the MODE pin forces the IC to stay in PWM Mode. Logic 0 allows the IC to automatically switch to PFM during light loads. If the MODE pin is toggled, the converter synchronizes its switching frequency to four times the frequency on the mode pin (f_{MODE}).

The MODE pin is internally buffered with a Schmitt trigger, which allows the MODE pin to be driven with slow rise and fall times. An asymmetric duty cycle for frequency synchronization is permitted, provided it is consistent with parametric table limits.

PGOOD Pin

The PGOOD pin is an open-drain that indicates that the IC is in regulation when its state is open. PGOOD pulls LOW under the following conditions:

- The IC has operated in cycle-by-cycle current limit for eight consecutive PWM cycles;
- The circuit is disabled, either after a fault occurs or when EN is LOW; or
- The IC is performing a soft-start.

Thermal Shutdown

When the die temperature increases, due to a high load condition and/or a high ambient temperature, the output switching is disabled until the temperature on the die has fallen sufficiently. The junction temperature at which the thermal shutdown activates is nominally 155°C with a 20°C hysteresis.

Minimum Off-Time Effect on Switching Frequency

$t_{OFF(MIN)}$ is 45 ns, which constrains the maximum V_{OUT}/V_{IN} that the FAN53540 can provide, while still maintaining a fixed switching frequency in PWM Mode. Regulation is maintained even though the regulator is unable to provide sufficient duty-cycle and operate at 2.4 MHz.

Switching frequency is the lower of 2.4 MHz or:

$$f_{SW}(\text{MHz}) = 22.2 \cdot \left(1 - \frac{V_{OUT} + I_{OUT} \cdot R_{OFF}}{V_{IN} + I_{OUT} \cdot (R_{OFF} - R_{ON})} \right) \quad (4)$$

where:

I_{OUT} = load current, in A;

R_{ON} = $R_{DS(ON)_P} + DCRL$, in Ohms; and

R_{OFF} = $R_{DS(ON)_N} + DCRL$, in Ohms.

A result of ≤ 0 MHz indicates 100% duty cycle operation.

Application Information

Selecting the Inductor

The output inductor must meet both the required inductance and the energy handling capability of the application. The inductor value affects the average current limit, output voltage ripple, transient response, and efficiency.

The ripple current (ΔI) of the regulator is:

$$\Delta I \approx \frac{V_{OUT}}{V_{IN}} \cdot \left(\frac{V_{IN} - V_{OUT}}{L \cdot f_{SW}} \right) \quad (5)$$

The maximum average load current, $I_{MAX(Load)}$, is related to the peak current limit, $I_{LIM(PK)}$, by the ripple current as:

$$I_{MAX(Load)} = I_{LIM(PK)} - \frac{\Delta I}{2} \quad (6)$$

The FAN53540 is optimized for operation with $L=470$ nH, but is stable with inductances up to 1.2 μ H (nominal). The inductor should be rated to maintain at least 80% of its value at $I_{LIM(PK)}$. Failure to do so lowers the amount of DC current the IC can deliver.

Efficiency is affected by the inductor DCR and inductance value. Decreasing the inductor value for a given physical size typically decreases the DCR; but since ΔI increases, the RMS current increases, as do core and skin-effect losses.

$$I_{RMS} = \sqrt{I_{OUT(DC)}^2 + \frac{\Delta I^2}{12}} \quad (7)$$

The increased RMS current produces higher losses through the $R_{DS(ON)}$ of the IC MOSFETs as well as the inductor ESR.

Increasing the inductor value produces lower RMS currents, but degrades transient response. For a given physical inductor size, increased inductance usually results in an inductor with lower saturation current.

Table 3 shows the effects on regulator performance of higher inductance than the recommended 470 nH.

Table 3. Inductor Value and Regulator Performance

$I_{MAX(Load)}$	ΔV_{OUT} (EQ. 8)	Transient Response
Increase	Decrease	Degraded

Inductor Current Rating

The FAN53540's current-limit circuit can allow a peak current of about 8.8 A to flow through L1 under worst-case conditions. If it is possible for the load to draw that much continuous current, the inductor should be capable of sustaining that current or failing in a safe manner.

For space-constrained applications, a lower current rating for L1 can be used. The FAN53540 may still protect these inductors in the event of a short circuit, but may not be able to protect the inductor from failure if the load is able to draw higher currents than the DC rating of the inductor.

Output Capacitor and V_{OUT} Ripple

Table 1 suggests 0805 capacitors, but 0603 capacitors may be used if space is at a premium. Due to voltage effects, the 0603 capacitors have a lower in-circuit capacitance, which can degrade transient response and output ripple.

Increasing C_{OUT} has a negligible effect on loop stability and can be increased to reduce output voltage ripple or to improve transient response. Output voltage ripple, ΔV_{OUT} , is:

$$\Delta V_{OUT} = \Delta I \cdot \left(\frac{1}{8 \cdot C_{OUT} \cdot f_{SW}} + ESR \right) \quad (8)$$

where C_{OUT} is the effective output capacitance. The capacitance of C_{OUT} decreases at higher output voltages, which results in higher ΔV_{OUT} . If large values are used for C_{OUT} , the regulator may fail to start under load. If an inductor value greater than 1.0 μH is used, at least 30 μF of C_{OUT} should be used to ensure transient response performance.

The lowest ΔV_{OUT} is obtained when the IC is in PWM Mode and, therefore, operating at 2.4 MHz. In PFM Mode, f_{SW} is reduced, causing ΔV_{OUT} to increase.

ESL Effects

The Equivalent Series Inductance (ESL) of the output capacitor network should be kept low to minimize the square-wave component of output ripple that results from the division ratio C_{OUT} ESL and the output inductor (L_{OUT}). The square-wave component due to the ESL can be estimated as:

$$\Delta V_{OUT(SQ)} \approx V_{IN} \cdot \frac{ESL_{COUT}}{L1} \quad (9)$$

A good practice to minimize this ripple is to use multiple output capacitors to achieve the desired C_{OUT} value. For example, to obtain $C_{OUT}=20 \mu\text{F}$, a single 22 μF 0805 would produce twice the square wave ripple of two 10 μF 0805.

To minimize ESL, try to use capacitors with the lowest ratio of length to width. 0805s have lower ESL than 1206 s. If very low output ripple is necessary, research vendors that produce 0508 or 0612 capacitors with ultra-low ESL. Placing additional small value capacitors near the load also reduces the high-frequency ripple components.

Input Capacitor

The 10 μF ceramic input capacitor should be placed as close as possible between the V_{IN} pin and PGND to minimize the parasitic inductance. If a long wire is used to bring power to the IC, additional “bulk” capacitance (electrolytic or tantalum) should be placed between C_{IN} and the power source lead to reduce under-damped ringing that can occur between the inductance of the power source leads and C_{IN} .

The effective C_{IN} capacitance value decreases as V_{IN} increases due to DC bias effects. This has no significant impact on regulator performance.

To reduce ringing and overshoot on V_{IN} and SW, an additional bypass capacitor C_{IN1} is recommended. Because this lower value capacitor has a higher resonant frequency than C_{IN} , C_{IN1} should be placed closer to the V_{IN} and GND pins of the IC than C_{IN} .

Layout Recommendations

The layout example below illustrates the recommended component placement and top copper (green) routing. The inductor in this example is the TDK VLC5020T-R47N.

To minimize V_{IN} and SW spikes and thereby reduce voltage stress on the IC's power switches, it is critical to minimize the loop length for the V_{IN} bypass capacitors.

Switching current paths through C_{IN} and C_{OUT} should be returned directly to the GND bumps of the IC on the top layer of the printed circuit board (PCB). V_{OUT} and GND connections to the system power and ground planes can be made through multiple vias placed as close as possible to the C_{OUT} capacitors. The regulator should be placed as close to its load as possible to minimize trace inductance and capacitance.

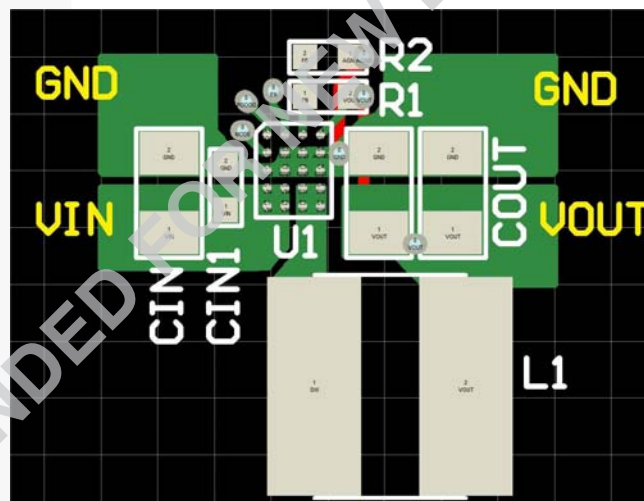

Figure 28. Recommended Layout

Connect the V_{OUT} pin and R1 directly to C_{OUT} using a low impedance path (shown in red in Figure 28. Recommended Layout). A ≥ 0.4 mm wide trace is recommended. Avoid routing this trace directly beneath SW unless separated by an internal GND plane.

If the MODE function is not required, extend the ground plane through the MODE pin to reduce the loop inductance for the V_{IN} bypass.

Thermal Considerations

Heat is removed from the IC through the solder bumps to the PCB copper. The junction-to-ambient thermal resistance (θ_{JA}) is largely a function of the PCB layout (size, copper weight, and trace width) and the temperature rise from junction to ambient (ΔT).

For the FAN53540UC, θ_{JA} is 38°C/W when mounted on its four-layer evaluation board in still air, with 2 oz. outer layer copper weight and 1 oz. inner layers. Halving the copper thickness results in an increased θ_{JA} of 48°C/W.

For long term reliable operation, the IC's junction temperature (T_J) should be maintained below 125°C.

Maximum IC power loss is 2.88 W. Figure 29 shows required power dissipation and derating for a FAN53540UC mounted on the Fairchild evaluation board in still air (38°C/W).

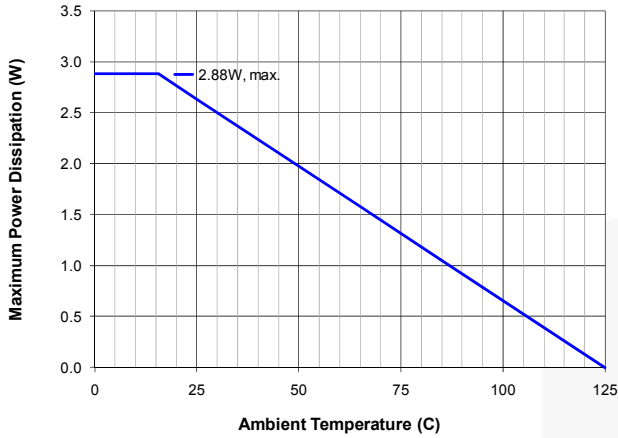

Figure 29. Power Derating

To calculate maximum operating temperature ($\leq 125^{\circ}\text{C}$) for a specific application:

1. Use efficiency graphs to determine efficiency for the desired V_{IN} , V_{OUT} , and load condition
2. Calculate IC power dissipation using:

$$P_{\text{IC}} = V_{\text{OUT}} \cdot I_{\text{LOAD}} \cdot \left(\frac{1}{\eta} - 1 \right) \quad (10)$$

where η is efficiency from Figure 4 through Figure 9.

3. Compute inductor copper losses using:

$$P_{\text{L}} = I_{\text{LOAD}}^2 \cdot \text{DCR}_{\text{L}} \quad (11)$$

4. Combine IC (step 2) and inductor losses (step 3) to determine total dissipation:

$$P_{\text{D}} = P_{\text{IC}} + P_{\text{L}} \quad (12)$$

5. Determine device operating temperature:

$$\Delta T = P_{\text{D}} \cdot R_{\text{OJA}} \text{ and } T_{\text{IC}} = T_{\text{AMB}} + \Delta T \quad (13)$$

Device temperature (T_{IC}) should not exceed 125°C .

A different approach, shown here as an example, uses the same equations to determine maximum inductor DCR for a specific application:

If a design requires a $5.0V_{\text{IN}}$, $1.2V_{\text{OUT}}$, $4A_{\text{RMS}}$, at 75°C :

- A. From Figure 4, η is $\sim 82\%$.
- B. From Eq. 10, $P_{\text{IC}} = 1,054 \text{ mW}$.
- C. From Eq. 13, maximum $P_{\text{D}} = 1,316 \text{ mW}$ for 50°C rise.
- D. From Eq. 12, $P_{\text{L}} = 262 \text{ mW}$.
- E. From Eq. 11, $\text{DCR} < 16.4 \text{ m}\Omega$.

Due to the $+0.4\%/^{\circ}\text{C}$ temperature coefficient of copper, inductor DCR must be further reduced to accommodate the $\sim 50^{\circ}\text{C}$ temperature rise.

To meet the design requirements, an inductor with a room temperature DCR of $< 13.6 \text{ m}\Omega$ is necessary.

Figure 30 shows the maximum ambient temperature where FAN53540UC can be used for a continuous load, at $5.0V_{\text{IN}}$:

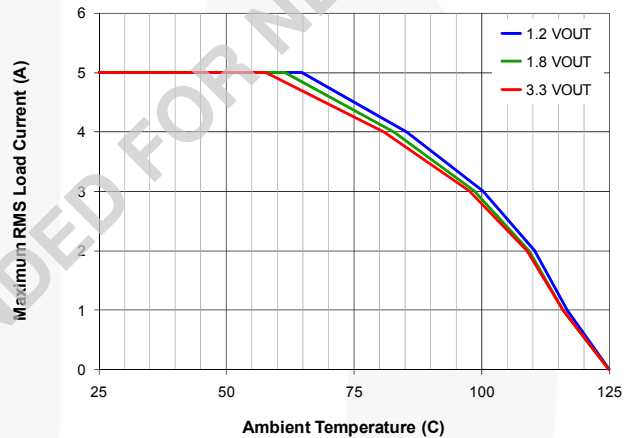

Figure 30. Load Current Derating⁽⁶⁾

Note:

6. The graph was empirically determined using an ultra-low DCR ($2.6 \text{ m}\Omega$) inductor. For physically smaller devices with higher DCR, further derating may be necessary.

DEVICE NOT RECOMMENDED FOR NEW DESIGN



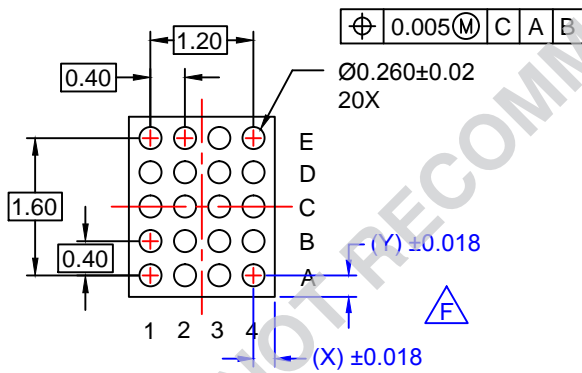
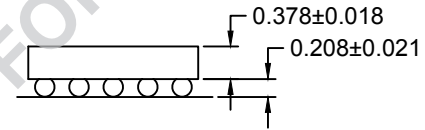
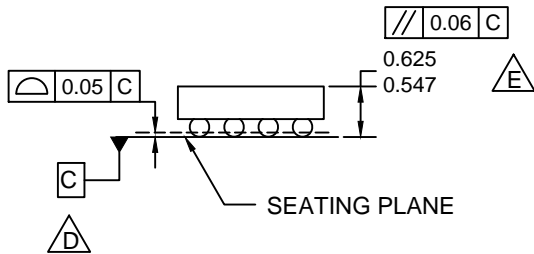
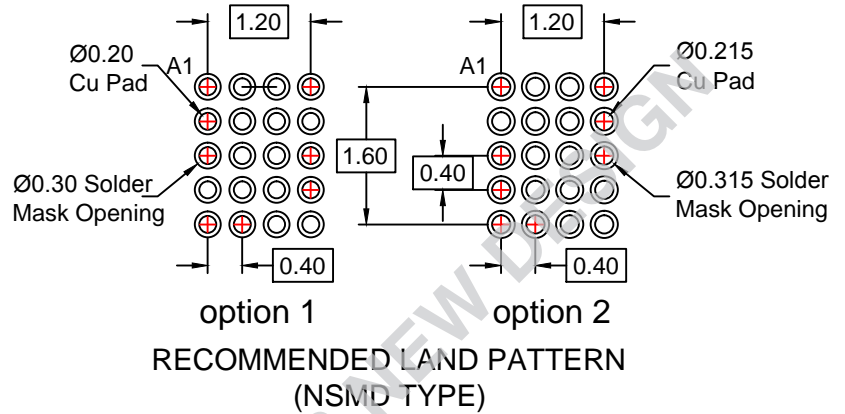
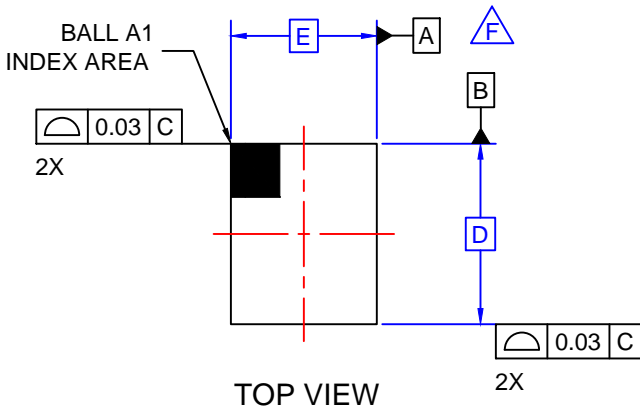

NOTES:

- A. NO JEDEC REGISTRATION APPLIES.
- B. DIMENSIONS ARE IN MILLIMETERS.
- C. DIMENSIONS AND TOLERANCE PER ASMEY14.5M, 2009.
- D. DATUM C IS DEFINED BY THE SPHERICAL CROWNS OF THE BALLS.
- E. PACKAGE NOMINAL HEIGHT IS 586 MICRONS ±39 MICRONS (547-625 MICRONS).
- F. FOR DIMENSIONS D, E, X, AND Y SEE PRODUCT DATASHEET.
- G. DRAWING FILNAME: MKT-UC020AArev4.



ON Semiconductor and  are trademarks of Semiconductor Components Industries, LLC dba ON Semiconductor or its subsidiaries in the United States and/or other countries. ON Semiconductor owns the rights to a number of patents, trademarks, copyrights, trade secrets, and other intellectual property. A listing of ON Semiconductor's product/patent coverage may be accessed at www.onsemi.com/site/pdf/Patent-Marking.pdf. ON Semiconductor reserves the right to make changes without further notice to any products herein. ON Semiconductor makes no warranty, representation or guarantee regarding the suitability of its products for any particular purpose, nor does ON Semiconductor assume any liability arising out of the application or use of any product or circuit, and specifically disclaims any and all liability, including without limitation special, consequential or incidental damages. Buyer is responsible for its products and applications using ON Semiconductor products, including compliance with all laws, regulations and safety requirements or standards, regardless of any support or applications information provided by ON Semiconductor. "Typical" parameters which may be provided in ON Semiconductor data sheets and/or specifications can and do vary in different applications and actual performance may vary over time. All operating parameters, including "Typicals" must be validated for each customer application by customer's technical experts. ON Semiconductor does not convey any license under its patent rights nor the rights of others. ON Semiconductor products are not designed, intended, or authorized for use as a critical component in life support systems or any FDA Class 3 medical devices or medical devices with a same or similar classification in a foreign jurisdiction or any devices intended for implantation in the human body. Should Buyer purchase or use ON Semiconductor products for any such unintended or unauthorized application, Buyer shall indemnify and hold ON Semiconductor and its officers, employees, subsidiaries, affiliates, and distributors harmless against all claims, costs, damages, and expenses, and reasonable attorney fees arising out of, directly or indirectly, any claim of personal injury or death associated with such unintended or unauthorized use, even if such claim alleges that ON Semiconductor was negligent regarding the design or manufacture of the part. ON Semiconductor is an Equal Opportunity/Affirmative Action Employer. This literature is subject to all applicable copyright laws and is not for resale in any manner.

PUBLICATION ORDERING INFORMATION

LITERATURE FULFILLMENT:

Literature Distribution Center for ON Semiconductor
19521 E. 32nd Pkwy, Aurora, Colorado 80011 USA
Phone: 303-675-2175 or 800-344-3860 Toll Free USA/Canada
Fax: 303-675-2176 or 800-344-3867 Toll Free USA/Canada
Email: orderlit@onsemi.com

N. American Technical Support: 800-282-9855 Toll Free
USA/Canada
Europe, Middle East and Africa Technical Support:
Phone: 421 33 790 2910
Japan Customer Focus Center
Phone: 81-3-5817-1050

ON Semiconductor Website: www.onsemi.com
Order Literature: <http://www.onsemi.com/orderlit>
For additional information, please contact your local
Sales Representative