

3000 W TVS in SMC

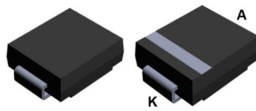

SMC
(JEDEC DO-214AB)

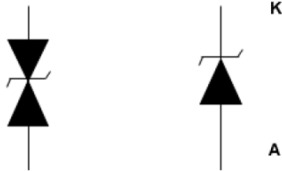

Bidirectional

Unidirectional

Features

- Peak pulse power:
 - 3000 W (10/1000 μ s)
 - up to 40 kW (8/20 μ s)
- Stand-off voltage range from 5 V to 188 V
- Unidirectional and bidirectional types
- Low leakage current: 0.2 μ A at 25 °C
- Operating T_j max: 175 °C
- JEDEC registered package outline
- Resin meets UL94, V0
- Lead finishing: matte tin plating

Complies with the following standards

- UL94, V0
- J-STD-020 MSL level 1
- J-STD-002, JESD 22-B102 E3 and MIL-STD-750, method 2026
- JESD-201 class 2 whisker test
- IPC7531 footprint and JEDEC registered package outline
- IEC 61000-4-4 level 4:
 - 4 kV
- IEC 61000-4-2, C = 150 pF, R = 330 Ω exceeds level 4:
 - 30 kV (air discharge)
 - 30 kV (contact discharge)

Description

The SMC30J TVS series are designed to protect sensitive equipment against electrostatic discharges according to IEC 61000-4-2, MIL STD 883 Method 3015, and electrical overstress such as IEC 61000-4-4 and 5. They are used for surges below 3000 W 10/1000 μ s.

This planar technology makes it compatible with high-end equipment and SMPS where low leakage current and high junction temperature are required to provide reliability and stability over time.

Product status link

[SMC30J5.0A](#), [SMC30J5.0CA](#),
[SMC30J6.0A](#), [SMC30J6.0CA](#),
[SMC30J6.5A](#), [SMC30J6.5CA](#),
[SMC30J8.5A](#), [SMC30J8.5CA](#),
[SMC30J10A](#), [SMC30J10CA](#),
[SMC30J12A](#), [SMC30J12CA](#),
[SMC30J13A](#), [SMC30J13CA](#),
[SMC30J15A](#), [SMC30J15CA](#),
[SMC30J16A](#), [SMC30J16CA](#),
[SMC30J18A](#), [SMC30J18CA](#),
[SMC30J20A](#), [SMC30J20CA](#),
[SMC30J22A](#), [SMC30J22CA](#),
[SMC30J24A](#), [SMC30J24CA](#),
[SMC30J26A](#), [SMC30J26CA](#),
[SMC30J28A](#), [SMC30J28CA](#),
[SMC30J30A](#), [SMC30J30CA](#),
[SMC30J33A](#), [SMC30J33CA](#),
[SMC30J36A](#), [SMC30J36CA](#),
[SMC30J40A](#), [SMC30J40CA](#),
[SMC30J48A](#), [SMC30J48CA](#),
[SMC30J58A](#), [SMC30J58CA](#),
[SMC30J64A](#), [SMC30J64CA](#),
[SMC30J70A](#), [SMC30J70CA](#),
[SMC30J85A](#), [SMC30J85CA](#),
[SMC30J100A](#), [SMC30J100CA](#),
[SMC30J130A](#), [SMC30J130CA](#),
[SMC30J154A](#), [SMC30J154CA](#),
[SMC30J170A](#), [SMC30J170CA](#),
[SMC30J188A](#), [SMC30J188CA](#)

1 Characteristics

Table 1. Absolute maximum ratings ($T_{amb} = 25\text{ }^{\circ}\text{C}$)

| Symbol | Parameter | Value | Unit | |
|-----------|--|---|-------------|--------------------|
| V_{PP} | Peak pulse voltage | IEC 61000-4-2 (C = 150 pF, R = 330 Ω) | | |
| | | Contact discharge | 30 | kV |
| | | Air discharge | 30 | |
| P_{PP} | Peak pulse power dissipation | T_j initial = T_{amb} | 3000 | W |
| T_{stg} | Storage temperature range | | -65 to +175 | $^{\circ}\text{C}$ |
| T_j | Operating junction temperature range | | -55 to +175 | $^{\circ}\text{C}$ |
| T_L | Maximum lead temperature for soldering during 10 s | | 260 | $^{\circ}\text{C}$ |

Figure 1. Electrical characteristics - parameter definitions

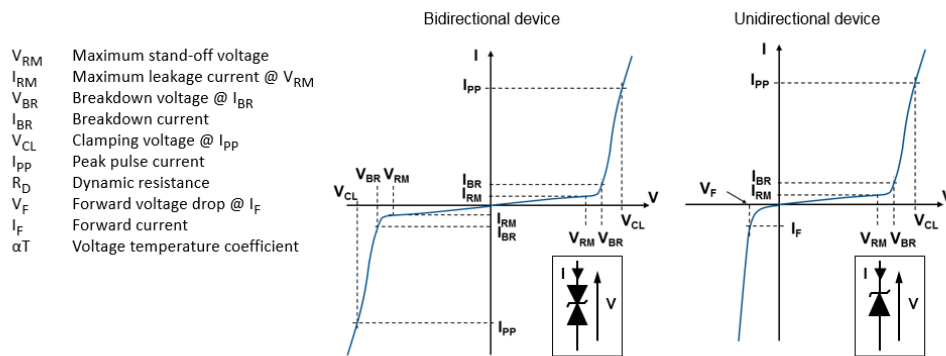

Figure 2. Pulse definition for electrical characteristics

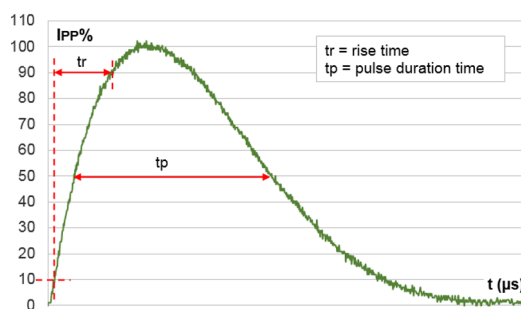

Table 2. Electrical characteristics - parameter values ($T_{amb} = 25\text{ }^{\circ}\text{C}$, unless otherwise specified)

| Type | I_{RM} max at V_{RM} | | | V_{BR} at I_R ⁽¹⁾ | | | | 10 / 1000 μs | | | 8 / 20 μs | | | αT |
|---------------|--------------------------|-----------------------|-----|----------------------------------|------|------|-------------|----------------------------|-------------------------|------------------|----------------------------|-------------------------|------------------|----------------------------|
| | | | | | | | | V_{CL} ⁽²⁾⁽³⁾ | I_{PP} ⁽⁴⁾ | R_D | V_{CL} ⁽²⁾⁽³⁾ | I_{PP} ⁽⁴⁾ | R_D | |
| | 25 $^{\circ}\text{C}$ | 85 $^{\circ}\text{C}$ | | Min. | Typ. | Max. | | Max. | | Max. | Max. | | Max. | |
| | μA | V | | V | | | mA | V | A | $\text{m}\Omega$ | V | A | $\text{m}\Omega$ | $10^{-4}/^{\circ}\text{C}$ |
| SMC30J5.0A/CA | 500 | 50 | 5 | 6.4 | 6.74 | 7.1 | 10 | 9.2 | 327 | 6.42 | 14.4 | 1610 | 4.53 | 5.7 |
| SMC30J6.0A/CA | 500 | 50 | 6 | 6.7 | 7.05 | 7.4 | 10 | 10.3 | 291 | 9.97 | 14.7 | 1580 | 4.62 | 5.9 |
| SMC30J6.5A/CA | 250 | 50 | 6.5 | 7.2 | 7.58 | 7.9 | 10 | 11.2 | 268 | 12.3 | 15.2 | 1530 | 4.77 | 6.1 |
| SMC30J8.5A/CA | 10 | 50 | 8.5 | 9.4 | 9.9 | 10.5 | 1 | 14.4 | 208 | 18.8 | 18.6 | 1280 | 6.33 | 7.3 |
| SMC30J10A/CA | 0.2 | 1 | 10 | 11.1 | 11.7 | 12.6 | 1 | 17 | 176 | 25 | 21.7 | 1170 | 7.78 | 7.8 |
| SMC30J12A/CA | 0.2 | 1 | 12 | 13.3 | 14 | 14.7 | 1 | 19.9 | 151 | 34.4 | 25.3 | 1045 | 10.1 | 8.3 |
| SMC30J13A/CA | 0.2 | 1 | 13 | 14.4 | 15.2 | 15.8 | 1 | 21.5 | 140 | 40.7 | 27.2 | 993 | 11.5 | 8.4 |
| SMC30J15A/CA | 0.2 | 1 | 15 | 16.7 | 17.6 | 18.5 | 1 | 24.4 | 123 | 48 | 32.5 | 926 | 15.1 | 8.8 |
| SMC30J16A/CA | 0.2 | 1 | 16 | 17.8 | 18.7 | 19.6 | 1 | 26 | 115 | 55.7 | 34.4 | 868 | 17.1 | 8.8 |
| SMC30J18A/CA | 0.2 | 1 | 18 | 20 | 21.1 | 22.2 | 1 | 29.2 | 103 | 68 | 39.3 | 800 | 21.4 | 9.2 |
| SMC30J20A/CA | 0.2 | 1 | 20 | 22.2 | 23.4 | 24.6 | 1 | 32.4 | 93 | 83.9 | 42.8 | 747 | 24.4 | 9.4 |
| SMC30J22A/CA | 0.2 | 1 | 22 | 24.4 | 25.7 | 27 | 1 | 35.5 | 85 | 100 | 48.3 | 701 | 30.4 | 9.6 |
| SMC30J24A/CA | 0.2 | 1 | 24 | 26.7 | 28.1 | 29.5 | 1 | 38.9 | 77 | 122 | 50 | 660 | 31.1 | 9.6 |
| SMC30J26A/CA | 0.2 | 1 | 26 | 28.9 | 30.4 | 31.9 | 1 | 42.1 | 71 | 144 | 53.5 | 626 | 34.5 | 9.7 |
| SMC30J28A/CA | 0.2 | 1 | 28 | 31.1 | 32.7 | 34.3 | 1 | 45.4 | 66 | 168 | 59 | 596 | 41.4 | 9.8 |
| SMC30J30A/CA | 0.2 | 1 | 30 | 33.3 | 35.1 | 36.9 | 1 | 48.4 | 62 | 185 | 64.3 | 569 | 48.2 | 9.9 |
| SMC30J33A/CA | 0.2 | 1 | 33 | 36.7 | 38.6 | 40.5 | 1 | 53.3 | 56 | 229 | 69.7 | 526 | 55.5 | 10 |
| SMC30J36A/CA | 0.2 | 1 | 36 | 40 | 42.1 | 44.2 | 1 | 58.1 | 48.4 | 287 | 76 | 503 | 63.2 | 10 |
| SMC30J40A/CA | 0.2 | 1 | 40 | 44.4 | 46.7 | 49 | 1 | 64.5 | 43.5 | 356 | 84 | 469 | 74.6 | 10.1 |
| SMC30J48A/CA | 0.2 | 1 | 48 | 53.2 | 56 | 58.8 | 1 | 76.6 | 38 | 468 | 100 | 409 | 101 | 10.3 |
| SMC30J58A/CA | 0.2 | 1 | 58 | 64.6 | 68 | 71.4 | 1 | 93.6 | 32 | 694 | 121 | 325 | 153 | 10.4 |
| SMC30J64A/CA | 0.2 | 1 | 64 | 71.3 | 75 | 78.8 | 1 | 103 | 29.1 | 832 | 134 | 289 | 191 | 10.5 |
| SMC30J70A/CA | 0.2 | 1 | 70 | 77.9 | 82 | 86.1 | 1 | 113 | 26.5 | 1015 | 146 | 256 | 234 | 10.5 |
| SMC30J85A/CA | 0.2 | 1 | 85 | 95 | 100 | 105 | 1 | 137 | 22 | 1455 | 178 | 205 | 356 | 10.6 |
| SMC30J100A/CA | 0.2 | 1 | 100 | 111 | 117 | 123 | 1 | 162 | 19 | 2053 | 212 | 170 | 524 | 10.7 |
| SMC30J130A/CA | 0.2 | 1 | 130 | 144 | 152 | 160 | 1 | 209 | 14 | 3500 | 265 | 125 | 840 | 10.8 |
| SMC30J154A/CA | 0.2 | 1 | 154 | 171 | 180 | 189 | 1 | 246 | 12 | 4750 | 317 | 102 | 1255 | 10.8 |
| SMC30J170A/CA | 0.2 | 1 | 170 | 190 | 200 | 210 | 1 | 275 | 11 | 5909 | 353 | 90 | 1589 | 10.8 |
| SMC30J188A/CA | 0.2 | 1 | 188 | 209 | 220 | 231 | 1 | 328 | 9 | 10778 | 388 | 80 | 1963 | 10.8 |

1. To calculate V_{BR} versus T_j : V_{BR} at $T_j = V_{BR}$ at $25\text{ }^{\circ}\text{C} \times (1 + \alpha T \times (T_j - 25))$
2. To calculate V_{CL} versus T_j : V_{CL} at $T_j = V_{CL}$ at $25\text{ }^{\circ}\text{C} \times (1 + \alpha T \times (T_j - 25))$
3. To calculate V_{CL} max versus $I_{PP\text{appli}}$: $V_{CL\text{max}} = V_{CL} - R_D \times (I_{PP} - I_{PP\text{appli}})$ where $I_{PP\text{appli}}$ is the surge current in the application
4. Surge capability given for both directions for unidirectional and bidirectional devices

1.1 Characteristics (curves)

Figure 3. Maximum peak power dissipation versus initial junction temperature

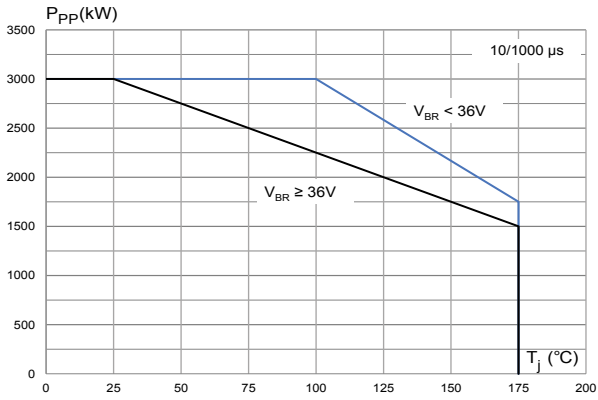

Figure 4. Maximum peak pulse power versus exponential pulse duration

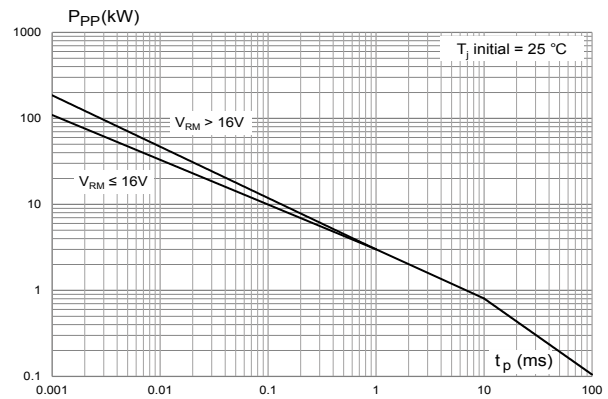

Figure 5. Maximum peak pulse current versus clamping voltage

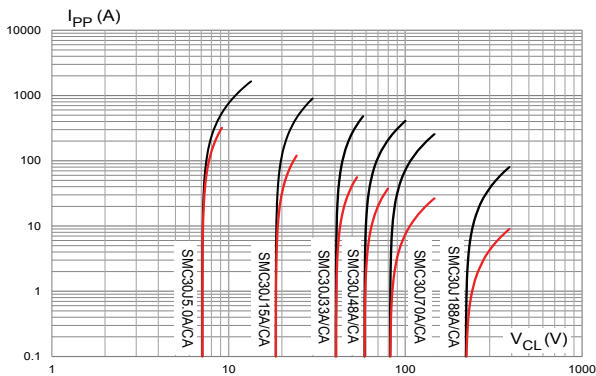

Figure 6. Dynamic resistance versus pulse duration

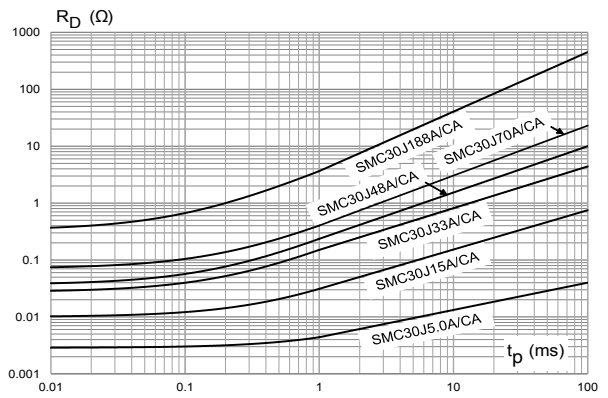

Figure 7. Junction capacitance versus reverse applied voltage (unidirectional type)

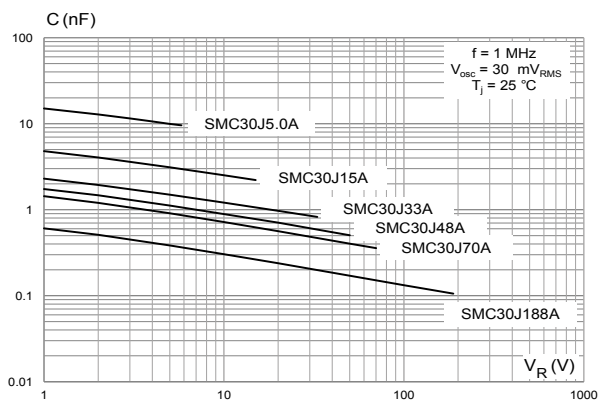

Figure 8. Junction capacitance versus applied voltage (bidirectional type)

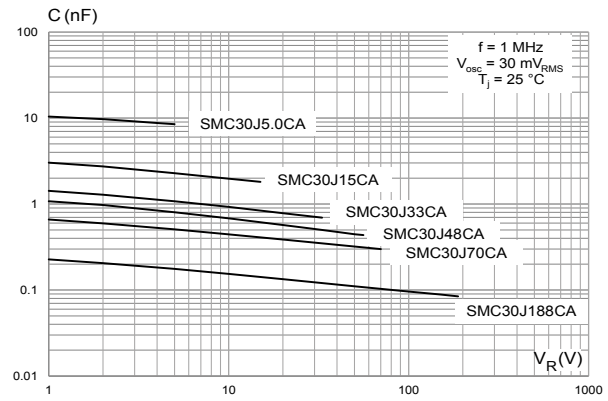

Figure 9. Leakage current versus junction temperature

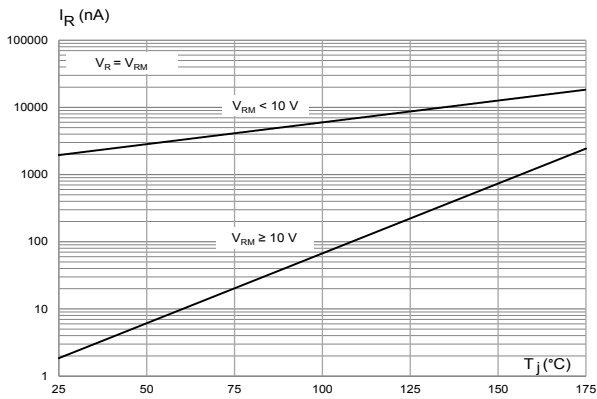

Figure 10. Peak forward voltage drop versus peak forward current

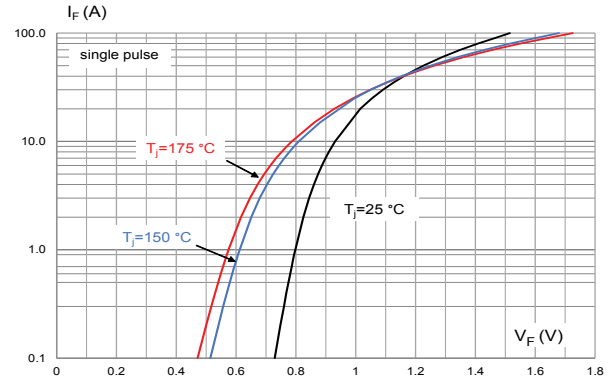

Figure 11. Thermal impedance junction to ambient versus pulse duration

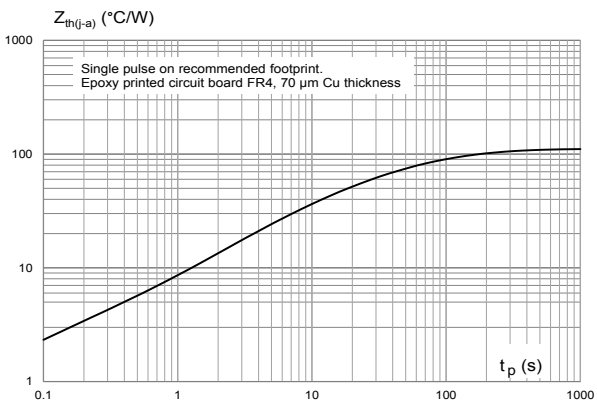
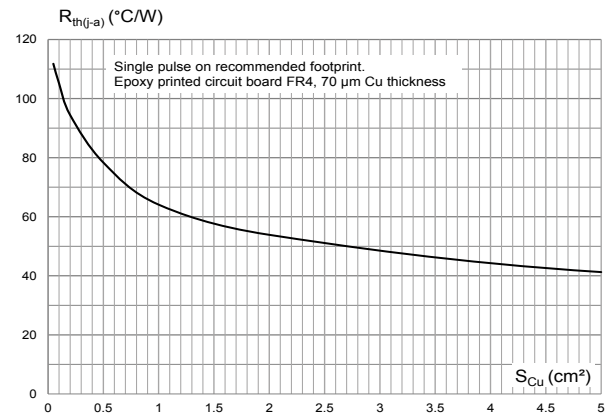

Figure 12. Thermal resistance junction to ambient versus copper area under each lead



2 Package information

In order to meet environmental requirements, ST offers these devices in different grades of **ECOPACK** packages, depending on their level of environmental compliance. ECOPACK specifications, grade definitions and product status are available at: www.st.com. ECOPACK is an ST trademark.

2.1 SMC package information

Figure 13. SMC package outline

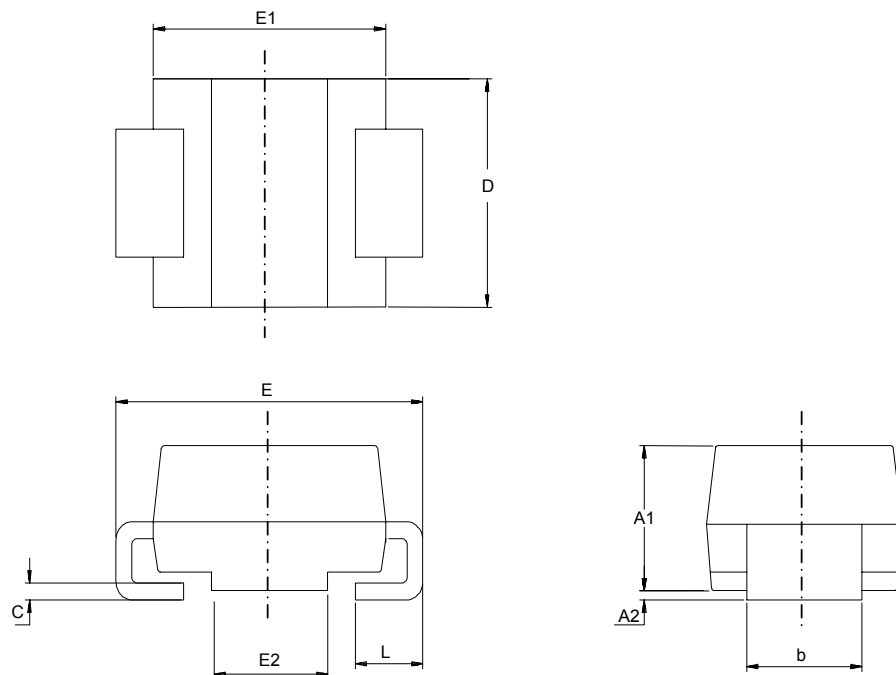

Table 3. SMC package mechanical data

| Ref. | Dimensions | | | |
|------|-------------|------|-----------------------------|-------|
| | Millimeters | | Inches (for reference only) | |
| | Min. | Max. | Min. | Max. |
| A1 | 1.90 | 2.45 | 0.075 | 0.096 |
| A2 | 0.05 | 0.20 | 0.002 | 0.008 |
| b | 2.90 | 3.20 | 0.114 | 0.126 |
| c | 0.15 | 0.40 | 0.006 | 0.016 |
| D | 5.55 | 6.25 | 0.218 | 0.246 |
| E | 7.75 | 8.15 | 0.305 | 0.321 |
| E1 | 6.60 | 7.15 | 0.260 | 0.281 |
| E2 | 4.40 | 4.70 | 0.173 | 0.185 |
| L | 0.75 | 1.50 | 0.030 | 0.060 |

Figure 14. Footprint recommendation

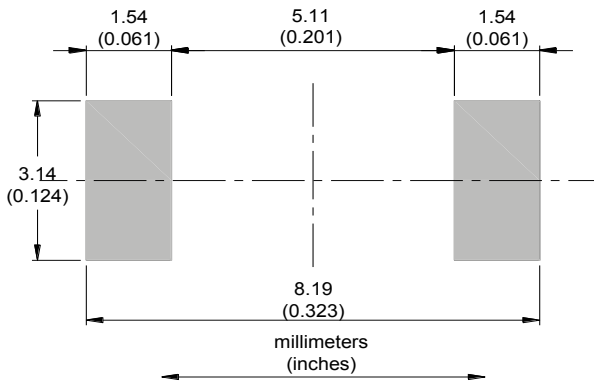

Figure 15. Marking layout

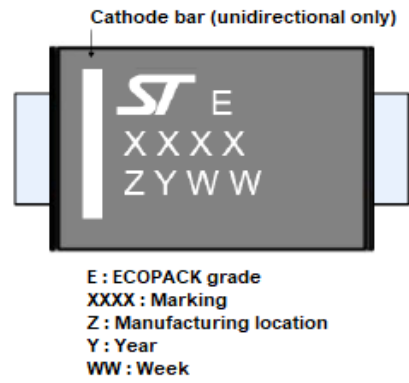
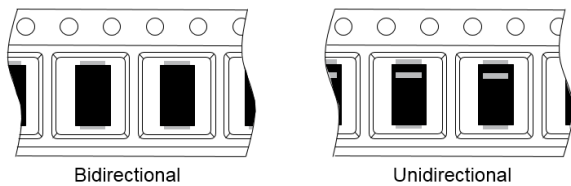

Figure 16. Package orientation in reel



Taped according to EIA-481
Pocket dimensions are not on scale.
Pocket shape may vary depending on package
On bidirectional devices, marking and logo may not be always in the same direction.

Figure 17. Tape and reel orientation

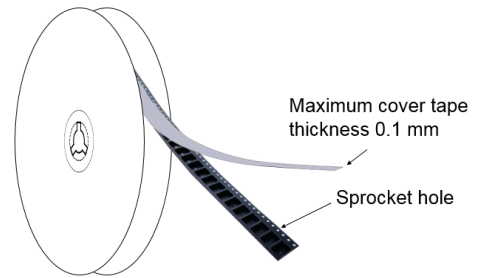

Figure 18. 13" reel dimension values (mm)

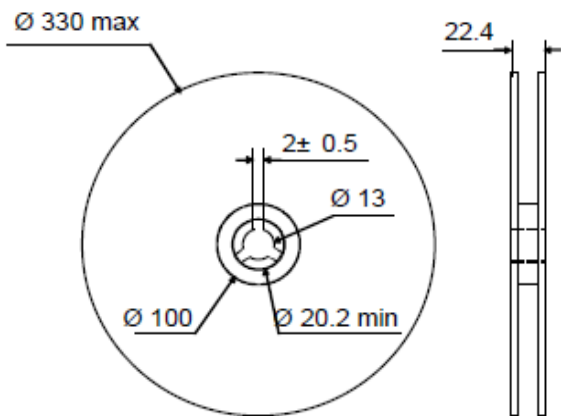

Figure 19. Inner box dimension values (mm)

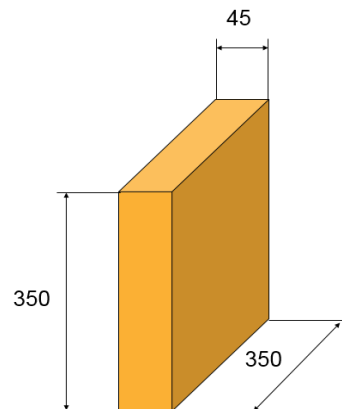
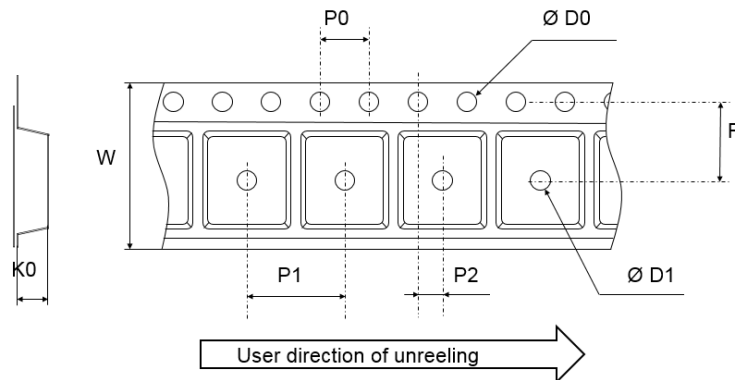

Figure 20. Tape outline



Note: Pocket dimensions are not on scale
Pocket shape may vary depending on package

Table 4. Tape dimension values

| Ref. | Dimensions | | |
|------|-------------|------|------|
| | Millimeters | | |
| | Min. | Typ. | Max. |
| D0 | 1.4 | 1.5 | 1.6 |
| D1 | 1.5 | | |
| F | 7.4 | 7.5 | 7.6 |
| K0 | 2.39 | 2.49 | 2.59 |
| P0 | 3.9 | 4.0 | 4.1 |
| P1 | 7.9 | 8.0 | 8.1 |
| P2 | 1.9 | 2.0 | 2.1 |
| W | 15.7 | 16 | 16.3 |

2.2 Reflow profile

Figure 21. ST ECOPACK recommended soldering reflow profile for PCB mounting

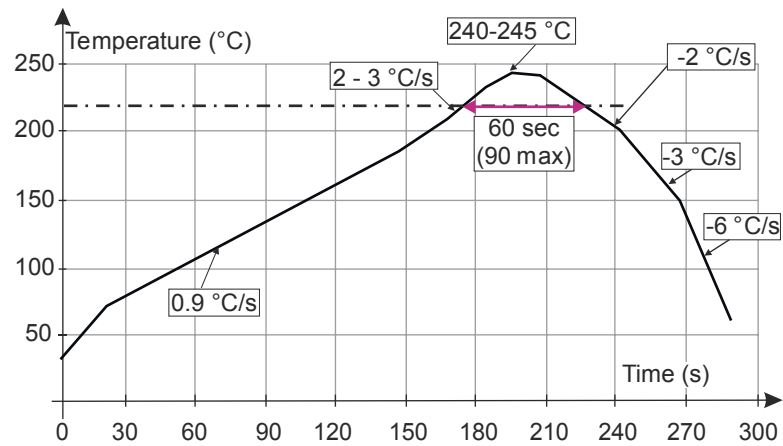

Note: Minimize air convection currents in the reflow oven to avoid component movement. Maximum soldering profile corresponds to the latest IPC/JEDEC J-STD-020.

3 Ordering information

Figure 22. Ordering information scheme

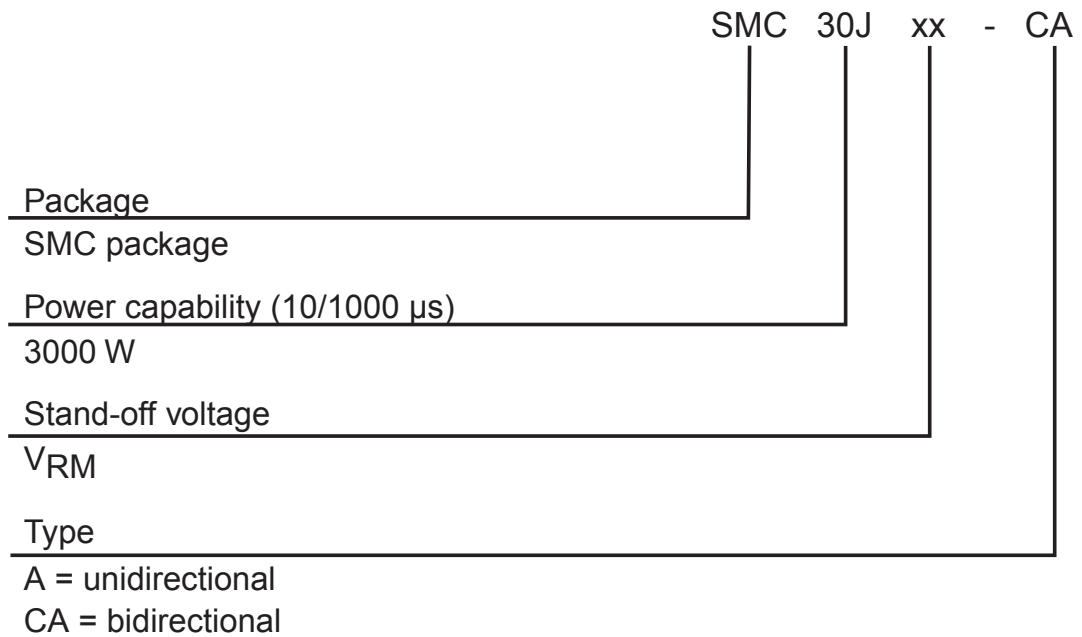

Table 5. Ordering information

| Order code | Marking | Package | Weight | Base qty. | Delivery mode |
|-----------------------------|----------------------|---------|--------|-----------|---------------|
| SMC30JxxA/CA ⁽¹⁾ | See Table 6. Marking | SMC | 0.25 g | 2500 | Tape and reel |

1. Where xx is V_{RM} and A or CA indicates unidirectional or bidirectional version.

Table 6. Marking

| Order code | Marking | Order code | Marking |
|------------|---------|-------------|---------|
| SMC30J5.0A | 3AAA | SMC30J5.0CA | 3BAA |
| SMC30J6.0A | 3AAB | SMC30J6.0CA | 3BAB |
| SMC30J6.5A | 3AAC | SMC30J6.5CA | 3BAC |
| SMC30J8.5A | 3AAD | SMC30J8.5CA | 3BAD |
| SMC30J10A | 3AAW | SMC30J10CA | 3BAW |
| SMC30J12A | 3AAF | SMC30J12CA | 3BAF |
| SMC30J13A | 3AAG | SMC30J13CA | 3BAG |
| SMC30J15A | 3AAH | SMC30J15CA | 3BAH |
| SMC30J16A | 3AAI | SMC30J16CA | 3BAI |
| SMC30J18A | 3AAJ | SMC30J18CA | 3BAJ |
| SMC30J20A | 3AAK | SMC30J20CA | 3BAK |
| SMC30J22A | 3AAL | SMC30J22CA | 3BAL |
| SMC30J24A | 3AAE | SMC30J24CA | 3BAE |
| SMC30J26A | 3AAM | SMC30J26CA | 3BAM |
| SMC30J28A | 3AAN | SMC30J28CA | 3BAN |
| SMC30J30A | 3AAO | SMC30J30CA | 3BAO |
| SMC30J33A | 3AAP | SMC30J33CA | 3BAP |
| SMC30J36A | 3AAQ | SMC30J36CA | 3BAQ |
| SMC30J40A | 3AAR | SMC30J40CA | 3BAR |
| SMC30J48A | 3AAS | SMC30J48CA | 3BAS |
| SMC30J58A | 3ACY | SMC30J58CA | 3BCY |
| SMC30J64A | 3ADE | SMC30J64CA | 3BDE |
| SMC30J70A | 3ADK | SMC30J70CA | 3BDK |
| SMC30J85A | 3ADZ | SMC30J85CA | 3BDZ |
| SMC30J100A | 3AEO | SMC30J100CA | 3BEO |
| SMC30J130A | 3AFS | SMC30J130CA | 3BFS |
| SMC30J154A | 3AGQ | SMC30J154CA | 3BGQ |
| SMC30J170A | 3AHG | SMC30J170CA | 3BHG |
| SMC30J188A | 3AHY | SMC30J188CA | 3BHY |

Revision history

Table 7. Document revision history

| Date | Version | Changes |
|-------------|---------|---|
| 28-Jul-2011 | 1 | Initial release. |
| 15-Jul-2015 | 2 | Updated features on cover page. Updated Table 1, Figure 3, Figure 5, Figure 6, Figure 7, Figure 8, Figure 10 and Figure 11. Updated Table 5. |
| 22-Jul-2015 | 3 | Updated Figure 9. |
| 12-Nov-2019 | 4 | Updated front page, Table 2. Electrical characteristics - parameter values ($T_{amb} = 25\text{ °C}$, unless otherwise specified) and Section 1.1 Characteristics (curves). |
| 10-Mar-2020 | 5 | Updated Table 2. Electrical characteristics - parameter values ($T_{amb} = 25\text{ °C}$, unless otherwise specified). |
| 25-Oct-2021 | 6 | Updated Figure 11. |
| 31-Jan-2022 | 7 | Range extension up to 188 V. |

IMPORTANT NOTICE – PLEASE READ CAREFULLY

STMicroelectronics NV and its subsidiaries (“ST”) reserve the right to make changes, corrections, enhancements, modifications, and improvements to ST products and/or to this document at any time without notice. Purchasers should obtain the latest relevant information on ST products before placing orders. ST products are sold pursuant to ST’s terms and conditions of sale in place at the time of order acknowledgement.

Purchasers are solely responsible for the choice, selection, and use of ST products and ST assumes no liability for application assistance or the design of Purchasers’ products.

No license, express or implied, to any intellectual property right is granted by ST herein.

Resale of ST products with provisions different from the information set forth herein shall void any warranty granted by ST for such product.

ST and the ST logo are trademarks of ST. For additional information about ST trademarks, please refer to www.st.com/trademarks. All other product or service names are the property of their respective owners.

Information in this document supersedes and replaces information previously supplied in any prior versions of this document.

© 2022 STMicroelectronics – All rights reserved