

# ADM1032

## ±1°C Remote and Local System Temperature Monitor

The ADM1032 is a dual-channel digital thermometer and under/overtemperature alarm intended for use in PCs and thermal management systems. The device can measure the temperature of a remote thermal diode, which can be located on the processor die or can be a discrete device (2N3904/06), accurate to 1°C. A novel measurement technique cancels out the absolute value of the transistor's base emitter voltage so that no calibration is required. The ADM1032 also measures its ambient temperature.

The ADM1032 communicates over a 2-wire serial interface compatible with System Management Bus (SMBus) standards. Under/overtemperature limits can be programmed into the device over the SMBus, and an  $\overline{\text{ALERT}}$  output signals when the on-chip or remote temperature measurement is out of range. This output can be used as an interrupt or as a SMBus alert. The  $\overline{\text{THERM}}$  output is a comparator output that allows CPU clock throttling or on/off control of a cooling fan. An ADM1032-1 and ADM1032-2 are available. The difference between the ADM1032 and the ADM1032-1 is the default value of the external  $\overline{\text{THERM}}$  limit. The ADM1032-2 has a different SMBus address. The SMBus address of the ADM1032-2 is 0x4D.

### Features

- On-chip and Remote Temperature Sensing
- Offset Registers for System Calibration
- 0.125°C Resolution/1°C Accuracy on Remote Channel
- 1°C Resolution/3°C Accuracy on Local Channel
- Fast (Up to 64 Measurements Per Second)
- 2-wire SMBus Serial Interface
- Supports SMBus Alert
- Programmable Under/Overtemperature Limits
- Programmable Fault Queue
- Overtemperature Fail-safe  $\overline{\text{THERM}}$  Output
- Programmable  $\overline{\text{THERM}}$  Limits
- Programmable  $\overline{\text{THERM}}$  Hysteresis
- 170  $\mu\text{A}$  Operating Current
- 5.5  $\mu\text{A}$  Standby Current
- 3.0 V to 5.5 V Supply
- Small 8-lead SOIC and MSOP Packages
- These are Pb-Free Devices\*

### Applications

- Desktop and Notebook Computers
- Smart Batteries
- Industrial Controllers
- Telecommunications Equipment
- Instrumentation
- Embedded Systems

\*For additional information on our Pb-Free strategy and soldering details, please download the ON Semiconductor Soldering and Mounting Techniques Reference Manual, SOLDERRM/D.



ON Semiconductor®

<http://onsemi.com>



SOIC-8 NB  
CASE 751

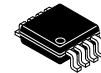

MSOP-8  
CASE 846AB

### PIN ASSIGNMENT

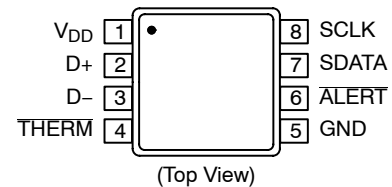

### MARKING DIAGRAMS

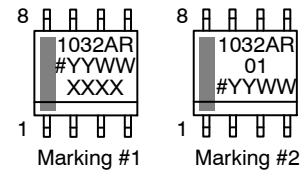

### SOIC-8 NB

1023AR = Specific Device Code  
# = Pb-Free Package  
YY = Year  
W = Work Week  
XX = Assembly Lot

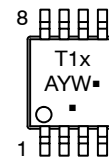

### MSOP-8

T1x = Refer to Order Info Table  
A = Assembly Location  
Y = Year  
W = Work Week  
▪ = Pb-Free Package

(Note: Microdot may be in either location)

### ORDERING INFORMATION

See detailed ordering and shipping information in the package dimensions section on page 16 of this data sheet.

# ADM1032

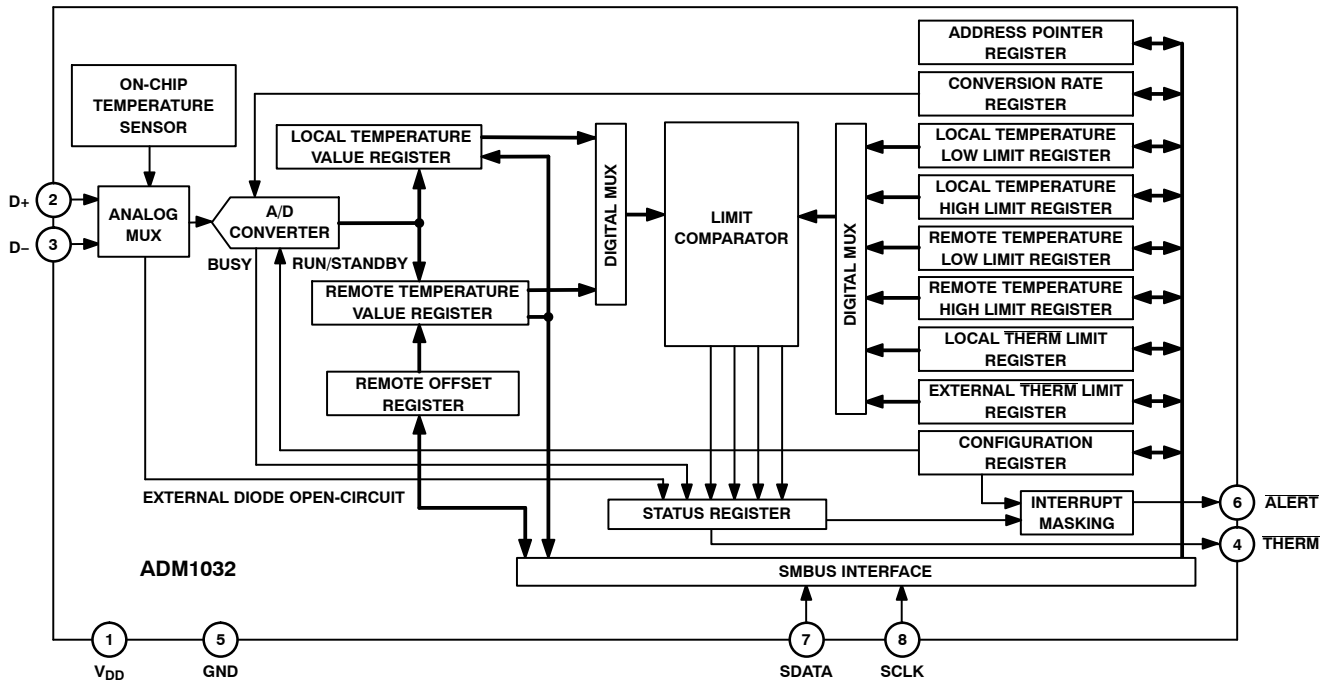

Figure 1. Functional Block Diagram

Table 1. ABSOLUTE MAXIMUM RATINGS

Parameter	Rating	Unit
Positive Supply Voltage ( $V_{DD}$ ) to GND	-0.3, +5.5	V
D+	-0.3 to $V_{DD} + 0.3$	V
D- to GND	-0.3 to +0.6	V
SCLK, SDATA, ALERT	-0.3 to +5.5	V
THERM	-0.3 to $V_{DD} + 0.3$	V
Input Current, SDATA, THERM	-1, +50	mA
Input Current, D-	$\pm 1$	mA
ESD Rating, All Pins (Human Body Model)	> 1000	V
Maximum Junction Temperature ( $T_{J\ Max}$ )	150	$^{\circ}C$
Storage Temperature Range	-65 to +150	$^{\circ}C$
IR Reflow Peak Temperature	220	$^{\circ}C$
IR Reflow Peak Temperature for Pb-Free	260	$^{\circ}C$
Lead Temperature (Soldering 10 sec)	300	$^{\circ}C$

Stresses exceeding Maximum Ratings may damage the device. Maximum Ratings are stress ratings only. Functional operation above the Recommended Operating Conditions is not implied. Extended exposure to stresses above the Recommended Operating Conditions may affect device reliability.

NOTE: This device is ESD sensitive. Use standard ESD precautions when handling.

Table 2. THERMAL CHARACTERISTICS

Package Type	$\theta_{JA}$	Unit
8-lead SOIC NB Package	121	$^{\circ}C$
8-lead MSOP Package	142	$^{\circ}C$

# ADM1032

**Table 3. PIN ASSIGNMENT**

Pin No.	Mnemonic	Description
1	V <sub>DD</sub>	Positive Supply, 3.0 V to 5.5 V.
2	D+	Positive Connection to Remote Temperature Sensor.
3	D-	Negative Connection to Remote Temperature Sensor.
4	THERM	THERM is an open-drain output that can be used to turn a fan on/off or throttle a CPU clock in the event of an overtemperature condition. Requires pullup to V <sub>DD</sub> , the same supply as the ADM1032. Note: Please refer to Power Sequencing Considerations; THERM Pin Pullup on page 15 for more information.
5	GND	Supply Ground Connection.
6	ALERT	Open-Drain Logic Output Used as Interrupt or SMBus Alert.
7	SDATA	Logic Input/Output, SMBus Serial Data. Open-drain output. Requires pullup resistor.
8	SCLK	Logic Input, SMBus Serial Clock. Requires pullup resistor.

**Table 4. ELECTRICAL CHARACTERISTICS**

Parameter	Conditions	Min	Typ	Max	Unit
<b>Power Supply</b>					
Supply Voltage, V <sub>DD</sub>		3.0	3.30	5.5	V
Average Operating Supply Current, I <sub>CC</sub>	0.0625 Conversions/Sec Rate (Note 1)	–	170	215	μA
	Standby Mode	–	5.5	10	μA
Undervoltage Lockout Threshold	V <sub>DD</sub> Input, Disables ADC, Rising Edge	2.35	2.55	2.8	V
Power-On Reset Threshold		1.0	–	2.4	V
<b>Temperature-To-Digital Converter</b>					
Local Sensor Accuracy	0 ≤ T <sub>A</sub> ≤ 100°C, V <sub>CC</sub> = 3 V to 3.6 V	–	±1	±3	°C
Resolution		–	1.0	–	°C
Remote Diode Sensor Accuracy	60°C ≤ T <sub>D</sub> ≤ 100°C, V <sub>CC</sub> = 3 V to 3.6 V 0°C ≤ T <sub>D</sub> ≤ 120°C	– –	– –	±1 ±3	°C
Resolution		–	0.125	–	°C
Remote Sensor Source Current	High Level (Note 2) Low Level (Note 2)	– –	230 13	– –	μA
Conversion Time	From stop bit to conversion complete Both channels: one-shot mode with averaging switched on  One-shot mode with averaging off (that is, conversion rate = 32 or 64 conversions per second)	35.7 5.7	– –	142.8 22.8	ms
<b>Open-Drain Digital Outputs (THERM, ALERT)</b>					
Output Low Voltage, V <sub>OL</sub>	I <sub>OUT</sub> = –6.0 mA (Note 2)	–	–	0.4	V
High Level Output Leakage Current, I <sub>OH</sub>	V <sub>OUT</sub> = V <sub>DD</sub> (Note 2)	–	0.1	1.0	μA
<b>Serial Bus Timing (Note 2)</b>					
Logic Input High Voltage, V <sub>IH</sub> SCLK, SDATA	V <sub>DD</sub> = 3.0 V to 5.5 V	2.1	–	–	V
Logic Input Low Voltage, V <sub>IL</sub>	V <sub>DD</sub> = 3.0 V to 5.5 V	–	–	0.8	V
Hysteresis SCLK, SDATA		–	500	–	mV
SDATA Output Low Sink Current	SDATA Forced to 0.6 V	6.0	–	–	mA
ALERT Output Low Sink Current	ALERT Forced to 0.4 V	1.0	–	–	mA
Logic Input Current, I <sub>IH</sub> , I <sub>IL</sub>		–1.0	–	+1.0	μA
Input Capacitance, SCLK, SDATA		–	5.0	–	pF

Table 4. ELECTRICAL CHARACTERISTICS

Parameter	Conditions	Min	Typ	Max	Unit
<b>Serial Bus Timing (Note 2)</b>					
Clock Frequency		-	-	400	kHz
SMBus Timeout (Note 3)		-	25	64	ms
SCLK Clock Low Time, $t_{LOW}$	$t_{LOW}$ between 10% Points	1.3	-	-	$\mu$ s
SCLK Clock High Time, $t_{HIGH}$	$t_{HIGH}$ between 90% Points	0.6	-	-	$\mu$ s
Start Condition Setup Time, $t_{SU:STA}$		600	-	-	ns
Start Condition Hold Time, $t_{HD:STA}$	Time from 10% of SDATA to 90% of SCLK	600	-	-	ns
Stop Condition Setup Time, $t_{SU:STO}$	Time from 90% of SCLK to 10% of SDATA	600	-	-	ns
Data Valid to SCLK Rising Edge Time, $t_{SU:DAT}$	Time for 10% or 90% of SDATA to 10% of SCLK	100	-	-	ns
Data Hold Time, $t_{HD:DAT}$		300	-	-	ns
Bus Free Time, $t_{BUF}$	Between Start/Stop Condition	1.3	-	-	$\mu$ s
SCLK, SDATA Rise Time, $t_R$		-	-	300	ns
SCLK, SDATA Fall Time, $t_F$		-	-	300	ns

1. See Table 10 for information on other conversion rates.
2. Guaranteed by design, not production tested.
3. The SMBus timeout is a programmable feature. By default, it is not enabled. Details on how to enable it are available in the Serial Bus Interface section.

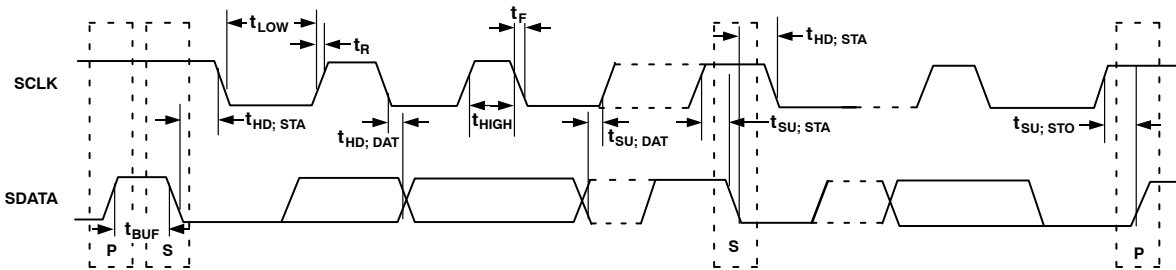

Figure 2. Serial Bus Timing Diagram

TYPICAL PERFORMANCE CHARACTERISTICS

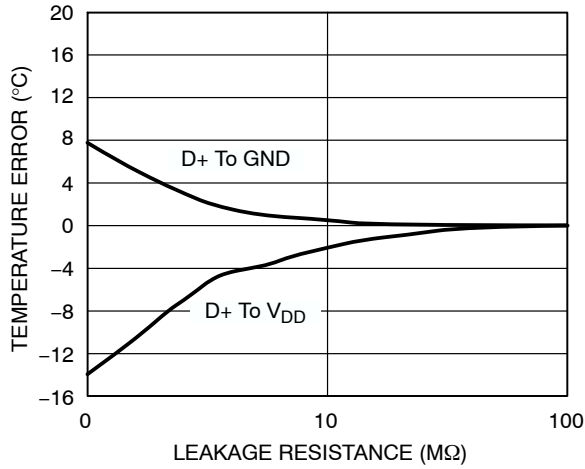

Figure 3. Temperature Error vs. Leakage Resistance

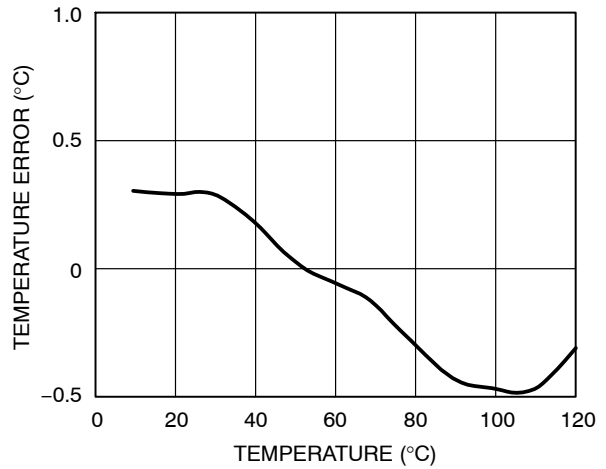

Figure 4. Temperature Error vs. Actual Temperature Using 2N3906

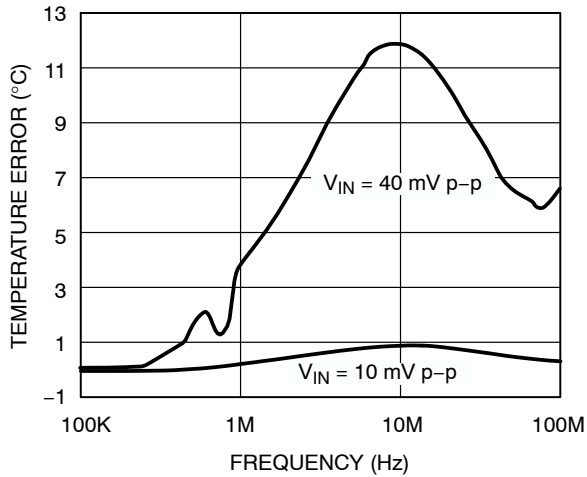

Figure 5. Temperature Error vs. Differential Mode Noise Frequency

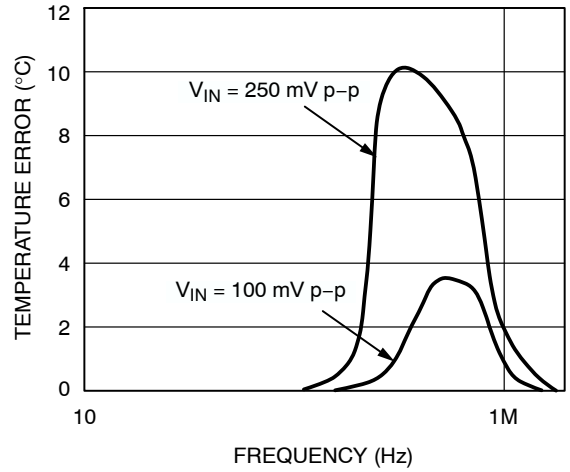

Figure 6. Temperature Error vs. Power Supply Noise Frequency

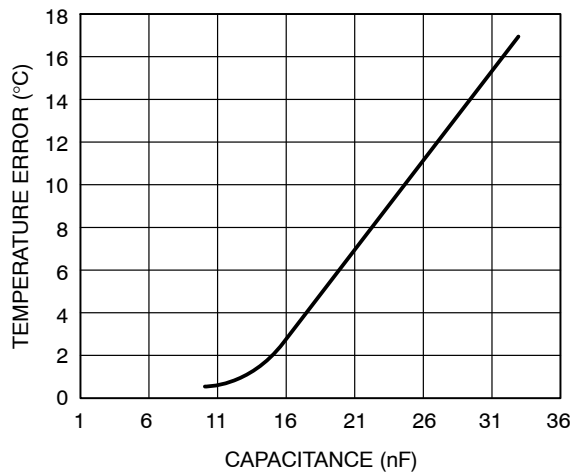

Figure 7. Temperature Error vs. Capacitance Between D+ and D-

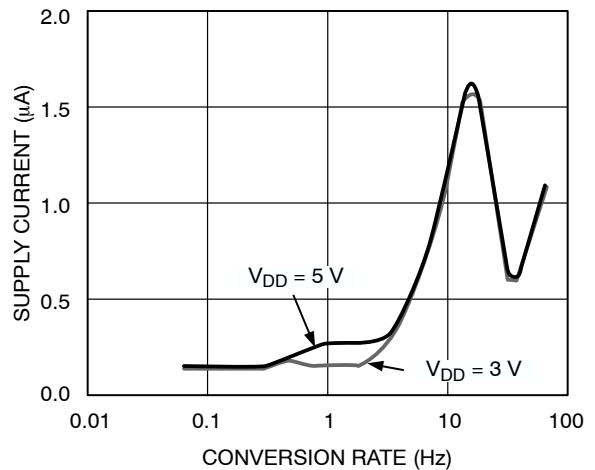

Figure 8. Operating Supply Current vs. Conversion Rate

TYPICAL PERFORMANCE CHARACTERISTICS (Cont'd)

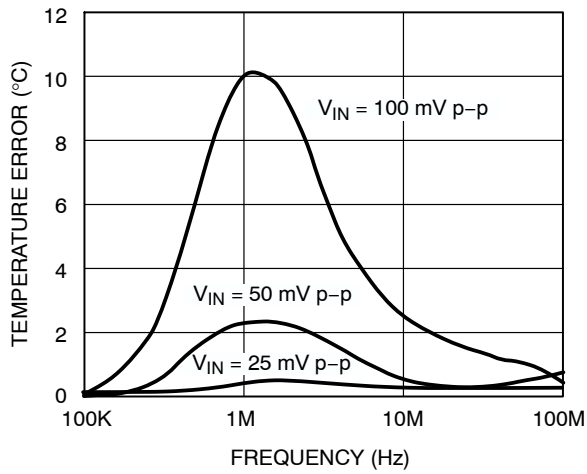

Figure 9. Temperature Error vs. Common-mode Noise Frequency

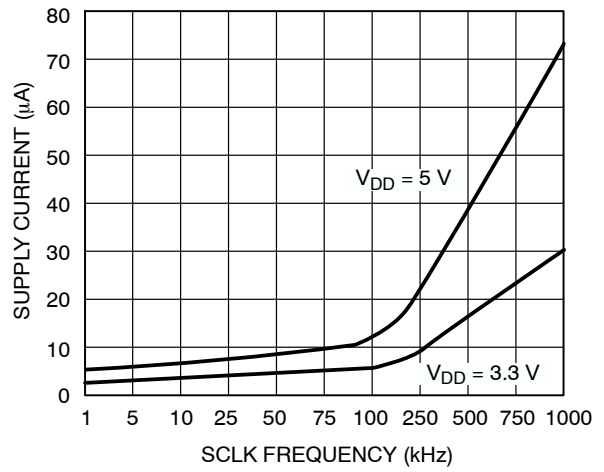

Figure 10. Standby Supply Current vs. Clock Frequency

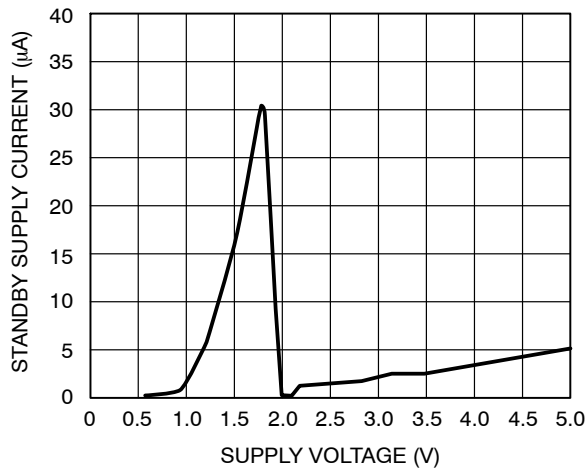

Figure 11. Standby Supply Current vs. Supply Voltage

**Functional Description**

The ADM1032 is a local and remote temperature sensor and overtemperature alarm. When the ADM1032 is operating normally, the on-board A/D converter operates in a free running mode. The analog input multiplexer alternately selects either the on-chip temperature sensor to measure its local temperature or the remote temperature sensor. These signals are digitized by the ADC, and the results are stored in the local and remote temperature value registers.

The measurement results are compared with local and remote, high, low, and  $\overline{\text{THERM}}$  temperature limits stored in nine on-chip registers. Out-of-limit comparisons generate flags that are stored in the status register, and one or more out-of-limit results cause the  $\overline{\text{ALERT}}$  output to pull low. Exceeding  $\overline{\text{THERM}}$  temperature limits causes the  $\overline{\text{THERM}}$  output to assert low.

The limit registers can be programmed, and the device controlled and configured, via the serial SMBus. The contents of any register can also be read back via the SMBus.

Control and configuration functions consist of:

- Switching the Device between Normal Operation and Standby Mode
- Masking or Enabling the  $\overline{\text{ALERT}}$  Output
- Selecting the Conversion Rate

**Measurement Method**

A simple method of measuring temperature is to exploit the negative temperature coefficient of a diode, or the base-emitter voltage of a transistor, operated at constant current. Unfortunately, this technique requires calibration to null out the effect of the absolute value of  $V_{BE}$ , which varies from device to device.

The technique used in the ADM1032 is to measure the change in  $V_{BE}$  when the device is operated at two different currents.

This is given by:

$$\Delta V_{BE} = (n_f) \frac{KT}{q} \times \ln(N) \tag{eq. 1}$$

where:

- $K$  is Boltzmann's constant ( $1.38 \times 10^{-23}$ )
- $q$  is the charge on the electron ( $1.6 \times 10^{-19}$  Coulombs)
- $T$  is the absolute temperature in Kelvins
- $N$  is the ratio of the two currents
- $n_f$  is the ideality factor of the thermal diode.

The ADM1032 is trimmed for an ideality factor of 1.008.

Figure 12 shows the input signal conditioning used to measure the output of an external temperature sensor. Figure 12 shows the external sensor as a substrate transistor, provided for temperature monitoring on some microprocessors, but it could equally well be a discrete transistor. If a discrete transistor is used, the collector is not grounded and should be linked to the base. To prevent ground noise interfering with the measurement, the more negative terminal of the sensor is not referenced to ground but is biased above ground by an internal diode at the D- input. If the sensor is operating in a noisy environment, C1 can optionally be added as a noise filter. Its value should be no more than 1000 pF. See the Layout Considerations section for more information on C1.

To measure  $\Delta V_{BE}$ , the sensor is switched between the operating currents of  $I$  and  $N \times I$ . The resulting waveform is passed through a 65 kHz low-pass filter to remove noise, and then to a chopper-stabilized amplifier that performs the functions of amplification and rectification of the waveform to produce a dc voltage proportional to  $\Delta V_{BE}$ . This voltage is measured by the ADC to give a temperature output in twos complement format. To further reduce the effects of noise, digital filtering is performed by averaging the results of 16 measurement cycles.

Signal conditioning and measurement of the internal temperature sensor is performed in a similar manner.

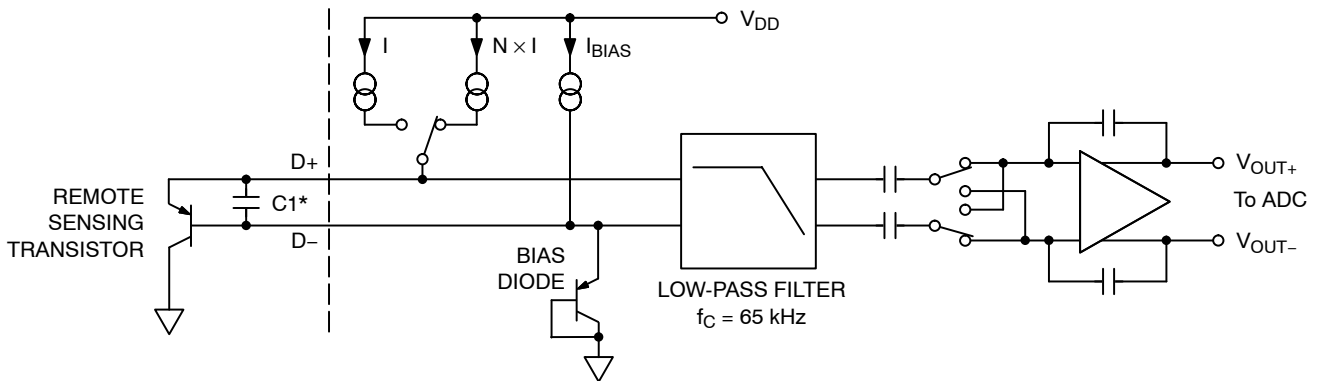

\* CAPACITOR C1 IS OPTIONAL AND IT SHOULD ONLY BE USED IN VERY NOISY ENVIRONMENTS. C1 = 1000 pF Max.

**Figure 12. Input Signal Conditioning**

### Temperature Data Format

One LSB of the ADC corresponds to 0.125°C, so the ADC can measure from 0°C to 127.875°C. The temperature data format is shown in Table 5 and Table 6.

The results of the local and remote temperature measurements are stored in the local and remote temperature value registers and are compared with limits programmed into the local and remote high and low limit registers.

**Table 5. TEMPERATURE DATA FORMAT (LOCAL TEMPERATURE AND REMOTE TEMPERATURE HIGH BYTE)**

Temperature	Digital Output
0°C	0 000 0000
1°C	0 000 0001
10°C	0 000 1010
25°C	0 001 1001
50°C	0 011 0010
75°C	0 100 1011
100°C	0 110 0100
125°C	0 111 1101
127°C	0 111 1111

**Table 6. EXTENDED TEMPERATURE RESOLUTION (REMOTE TEMPERATURE LOW BYTE)**

Extended Resolution	Remote Temperature Low Byte
0.000°C	0 000 0000
0.125°C	0 010 0000
0.250°C	0 100 0000
0.375°C	0 110 0000
0.500°C	1 000 0000
0.625°C	1 010 0000
0.750°C	1 100 0000
0.875°C	1 110 0000

### ADM1032 Registers

The ADM1032 contains registers that are used to store the results of remote and local temperature measurements and high and low temperature limits and to configure and control the device. A description of these registers follows, and further details are given in Table 7 to Table 11.

#### Address Pointer Register

The address pointer register itself does not have, or require, an address because it is the register the first data byte of every write operation is written to automatically. This data byte is an address pointer that sets up one of the other registers for the second byte of the write operation or for a subsequent read operation.

The power-on default value of the address pointer register is 00h. Therefore, if a read operation is performed immediately after power-on without first writing to the address pointer, the value of the local temperature is returned because its register address is 00h.

### Value Registers

The ADM1032 has three registers to store the results of local and remote temperature measurements. These registers are written to by the ADC only and can be read over the SMBus.

#### Offset Register

Series resistance on the D+ and D– lines in processor packages and clock noise can introduce offset errors into the remote temperature measurement. To achieve the specified accuracy on this channel, these offsets must be removed.

The offset value is stored as an 11-bit, twos complement value in Register 11h (high byte) and Register 12h (low byte, left justified). The value of the offset is negative if the MSB of Register 11h is 1 and positive if the MSB of Register 12h is 0. The value is added to the measured value of the remote temperature.

The offset register powers up with a default value of 0°C and has no effect if nothing is written to them.

**Table 7. SAMPLE OFFSET REGISTER CODES**

Offset Value	11h	12h
-4°C	1 111 1100	0 000 0000
-1°C	1 111 1111	0 000 0000
-0.125°C	1 111 1111	1 110 0000
0°C	0 000 0000	0 000 0000
+0.125°C	0 000 0000	0 010 0000
+1°C	0 000 0001	0 000 0000
+4°C	0 000 0100	0 000 0000

#### Status Register

Bit 7 of the status register indicates that the ADC is busy converting when it is high. Bit 6 to Bit 3, Bit 1, and Bit 0 are flags that indicate the results of the limit comparisons. Bit 2 is set when the remote sensor is open circuit.

If the local and/or remote temperature measurement is above the corresponding high temperature limit, or below or equal to the corresponding low temperature limit, one or more of these flags is set. These five flags (Bit 6 to Bit 2) are NOR'ed together, so that if any of them are high, the  $\overline{\text{ALERT}}$  interrupt latch is set and the  $\overline{\text{ALERT}}$  output goes low. Reading the status register clears the five flag bits, provided that the error conditions that caused the flags to be set have gone away. While a limit comparator is tripped due to a value register containing an out-of-limit measurement, or the sensor is open circuit, the corresponding flag bit cannot be reset. A flag bit can only be reset if the corresponding value register contains an in-limit measurement or the sensor is good.

The  $\overline{\text{ALERT}}$  interrupt latch is not reset by reading the status register but is reset when the  $\overline{\text{ALERT}}$  output is serviced by the master reading the device address, provided the error condition has gone away and the status register flag bits are reset.

When Flag 1 and Flag 0 are set, the  $\overline{\text{THERM}}$  output goes low to indicate that the temperature measurements are



outside the programmed limits.  $\overline{\text{THERM}}$  output does not need to be reset, unlike the  $\overline{\text{ALERT}}$  output. Once the measurements are within the limits, the corresponding status register bits are reset and the  $\overline{\text{THERM}}$  output goes high.

**Table 8. STATUS REGISTER BIT ASSIGNMENTS**

Bit	Name	Function
7	BUSY	1 When ADC Converting
6	LHIGH (Note 1)	1 When Local High Temp Limit Tripped
5	LLOW (Note 1)	1 When Local Low Temp Limit Tripped
4	RHIGH (Note 1)	1 When Remote High Temp Limit Tripped
3	RLOW (Note 1)	1 When Remote Low Temp Limit Tripped
2	OPEN (Note 1)	1 When Remote Sensor Open-Circuit
1	RTHRM	1 When Remote $\overline{\text{THERM}}$ Limit Tripped
0	LTHRM1	1 When Local $\overline{\text{THERM}}$ Limit Tripped

1. These flags stay high until the status register is read, or they are reset by POR.

### Configuration Register

Two bits of the configuration register are used. If Bit 6 is 0, which is the power-on default, the device is in operating mode with the ADC converting. If Bit 6 is set to 1, the device is in standby mode and the ADC does not convert. The SMBus does, however, remain active in standby mode so values can be read from or written to the SMBus. The  $\overline{\text{ALERT}}$  and  $\overline{\text{THERM}}$  O/Ps are also active in standby mode.

Bit 7 of the configuration register is used to mask the alert output. If Bit 7 is 0, which is the power-on default, the output is enabled. If Bit 7 is set to 1, the output is disabled.

**Table 9. CONFIGURATION REGISTER BIT ASSIGNMENTS**

Bit	Name	Function	Power-On Default
7	MASK1	0 = $\overline{\text{ALERT}}$ Enabled 1 = $\overline{\text{ALERT}}$ Masked	0
6	RUN/STOP	0 = Run 1 = Standby	0
5 to 0		Reserved	0

### Conversion Rate Register

The lowest four bits of this register are used to program the conversion rate by dividing the internal oscillator clock by 1, 2, 4, 8, 16, 32, 64, 128, 256, 512, or 1024 to give conversion times from 15.5 ms (Code 0Ah) to 16 seconds (Code 00h). This register can be written to and read back over the SMBus. The higher four bits of this register are unused and must be set to 0. Use of slower conversion times greatly reduces the device power consumption, as shown in Table 10.

**Table 10. CONVERSION RATE REGISTER CODES**

Data	Conversion/Sec	Average Supply Current mA Typ at $V_{DD} = 5.5\text{ V}$
00h	0.0625	0.17
01h	0.125	0.20
02h	0.25	0.21
03h	0.5	0.24
04h	1	0.29
05h	2	0.40
06h	4	0.61
07h	8	1.1
08h	16	1.9
09h	32	0.73
0Ah	64	1.23
0B to FFh	Reserved	

### Limit Registers

The ADM1032 has nine limit registers to store local and remote, high, low, and  $\overline{\text{THERM}}$  temperature limits. These registers can be written to and read back over the SMBus.

The high limit registers perform a > comparison, while the low limit registers perform a < or = comparison. For example, if the high limit register is programmed with 80°C, measuring 81°C results in an alarm condition. If the low limit register is programmed with 0°C, measuring 0°C or lower results in an alarm condition. Exceeding either the local or remote  $\overline{\text{THERM}}$  limit asserts  $\overline{\text{THERM}}$  low. A default hysteresis value of 10°C is provided, which applies to both channels. This hysteresis can be reprogrammed to any value after powerup (Reg 0x21h).

### One-Shot Register

The one-shot register is used to initiate a single conversion and comparison cycle when the ADM1032 is in standby mode, after which the device returns to standby. This is not a data register as such, and it is the write operation that causes the one-shot conversion. The data written to this address is irrelevant and is not stored. The conversion time on a single shot is 96 ms when the conversion rate is 16 conversions per second or less. At 32 conversions per second, the conversion time is 15.3 ms. This is because averaging is disabled at the faster conversion rates (32 and 64 conversions per second).

### Consecutive $\overline{\text{ALERT}}$ Register

This value written to this register determines how many out-of-limit measurements must occur before an  $\overline{\text{ALERT}}$  is generated. The default value is that one out-of-limit measurement generates an  $\overline{\text{ALERT}}$ . The maximum value that can be chosen is four. The purpose of this register is to allow the user to perform some filtering of the output. This is particularly useful at the faster two conversion rates where no averaging takes place.

# ADM1032

**Table 11. CONSECUTIVE ALERT REGISTER CODES**

Register Value	Number of Out-of-Limit Measurements Required
yxxx 000x	1
yxxx 001x	2
yxxx 011x	3
yxxx 111x	4

NOTE: x = don't care bits, and y = SMBus timeout bit.  
Default = 0. See SMBus section for more information.

## Serial Bus Interface

Control of the ADM1032 is carried out via the serial bus. The ADM1032 is connected to this bus as a slave device, under the control of a master device.

There is a programmable SMBus timeout. When this is enabled, the SMBus times out after typically 25 ms of no activity. However, this feature is not enabled by default. To enable it, set Bit 7 of the consecutive alert register (Address = 22h).

**Table 12. LIST OF ADM1032 REGISTERS**

Read Address (Hex)	Write Address (Hex)	Name	Power-On Default
Not Applicable	Not Applicable	Address Pointer	Undefined
00	Not Applicable	Local Temperature Value	0000 0000 (00h)
01	Not Applicable	External Temperature Value High Byte	0000 0000 (00h)
02	Not Applicable	Status	Undefined
03	09	Configuration	0000 0000 (00h)
04	0A	Conversion Rate	0000 1000 (08h)
05	0B	Local Temperature High Limit	0101 0101 (55h) (85°C)
06	0C	Local Temperature Low Limit	0000 0000 (00h) (0°C)
07	0D	External Temperature High Limit High Byte	0101 0101 (55h) (85°C)
08	0E	External Temperature Low Limit High Byte	0000 0000 (00h) (0°C)
Not Applicable	0F	One-Shot	
10	Not Applicable	External Temperature Value Low Byte	0000 0000
11	11	External Temperature Offset High Byte	0000 0000
12	12	External Temperature Offset Low Byte	0000 0000
13	13	External Temperature High Limit Low Byte	0000 0000
14	14	External Temperature Low Limit Low Byte	0000 0000
19	19	External THERM Limit	0101 0101 (55h) (85°C) (ADM1032) 0110 1100 (6Ch) (108°C) (ADM1032-1)
20	20	Local THERM Limit	0101 0101 (55h) (85°C)
21	21	THERM Hysteresis	0000 1010 (0Ah) (10°C)
22	22	Consecutive ALERT	0000 0001 (01h)
FE	Not Applicable	Manufacturer ID	0100 0001 (41h)
FF	Not Applicable	Die Revision Code	Undefined

NOTE: Writing to Address 0F causes the ADM1032 to perform a single measurement. It is not a data register as such and it does not matter what data is written to it.

## Addressing the Device

In general, every SMBus device has a 7-bit device address (except for some devices that have extended, 10-bit addresses). When the master device sends a device address over the bus, the slave device with that address responds. The ADM1032 and the ADM1032-1 are available with one SMBus address, which is Hex 4C (1001 100). The ADM1032-2 is also available with one SMBus address; however, that address is Hex 4D (1001 101).

The serial bus protocol operates as follows:

1. The master initiates data transfer by establishing a START condition, defined as a high-to-low transition on the serial data line SDATA, while the serial clock line SCLK remains high. This indicates that an address/data stream follows. All slave peripherals connected to the serial bus respond to the START condition and shift in the next eight bits, consisting of a 7-bit address (MSB first) plus an R/W bit, which determines the

direction of the data transfer, that is, whether data is written to or read from the slave device.

The peripheral whose address corresponds to the transmitted address responds by pulling the data line low during the low period before the ninth clock pulse, known as the acknowledge bit. All other devices on the bus now remain idle while the selected device waits for data to be read from or written to it. If the  $R/\overline{W}$  bit is a 0, the master writes to the slave device. If the  $R/\overline{W}$  bit is a 1, the master reads from the slave device.

2. Data is sent over the serial bus in sequences of nine clock pulses, eight bits of data followed by an acknowledge bit from the slave device. Transitions on the data line must occur during the low period of the clock signal and remain stable during the high period, since a low-to-high transition when the clock is high can be interpreted as a STOP signal. The number of data bytes that can be transmitted over the serial bus in a single read or write operation is limited only by what the master and slave devices can handle.
3. When all data bytes are read or written, stop conditions are established. In write mode, the master pulls the data line high during the 10th clock pulse to assert a STOP condition. In read mode, the master device overrides the acknowledge bit by pulling the data line high during the low period before the ninth clock pulse. This is known as no acknowledge. The master then takes the data line low during the low period before the 10th clock pulse, and high during the 10th clock pulse to assert a STOP condition.

Any number of bytes of data can be transferred over the serial bus in one operation, but it is not possible to mix read and write in one operation because the type of operation is determined at the beginning and cannot subsequently be changed without starting a new operation.

In the case of the ADM1032, write operations contain either one or two bytes, while read operations contain one byte and perform the following functions.

To write data to one of the device data registers or read data from it, the address pointer register must first be set so

that the correct data register is addressed. The first byte of a write operation always contains a valid address that is stored in the address pointer register. If data is written to the device, the write operation contains a second data byte that is written to the register selected by the address pointer register.

This is illustrated in Figure 13. The device address is sent over the bus followed by  $R/\overline{W}$  set to 0. This is followed by two data bytes. The first data byte is the address of the internal data register to be written to, which is stored in the address pointer register. The second data byte is the data to be written to the internal data register.

When reading data from a register, there are two possibilities:

1. If the address pointer register value is unknown or not the desired value, it is first necessary to set it to the correct value before data can be read from the desired data register. This is done by performing a write to the ADM1032 as before, but only the data byte containing the register read address is sent because data is not to be written to the register. This is shown in Figure 14.

A read operation is then performed consisting of the serial bus address,  $R/\overline{W}$  bit set to 1, followed by the data byte read from the data register. This is shown in Figure 15.

2. If the address pointer register is known to be at the desired address already, data can be read from the corresponding data register without first writing to the address pointer register and Figure 14 can be omitted.

#### NOTES:

1. Although it is possible to read a data byte from a data register without first writing to the address pointer register, if the address pointer register is already at the correct value, it is not possible to write data to a register without writing to the address pointer register. The first data byte of a write is always written to the address pointer register.
2. Don't forget that some of the ADM1032 registers have different addresses for read and write operations. The write address of a register must be written to the address pointer if data is to be written to that register, but it is not possible to read data from that address. The read address of a register must be written to the address pointer before data can be read from that register.

# ADM1032

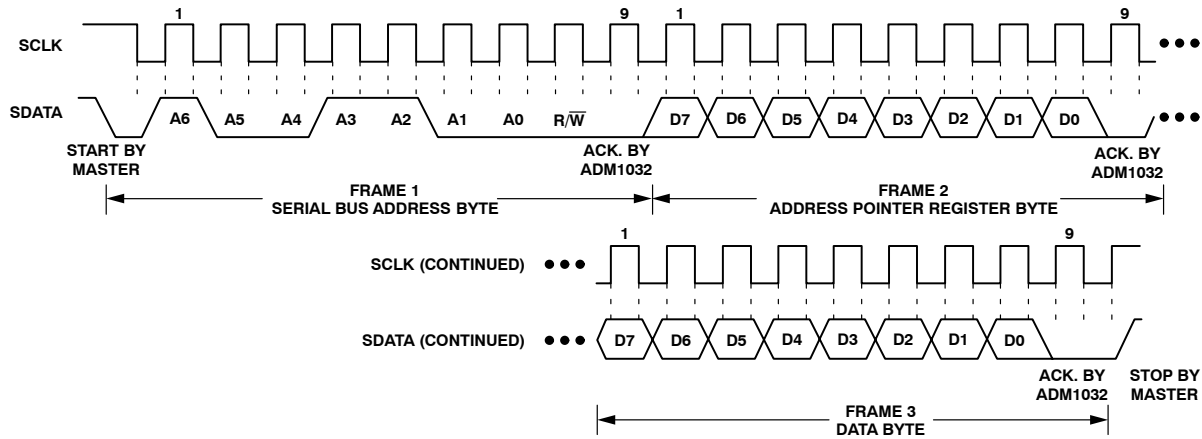

Figure 13. Writing a Register Address to the Address Pointer Register, then Writing Data to the Selected Register

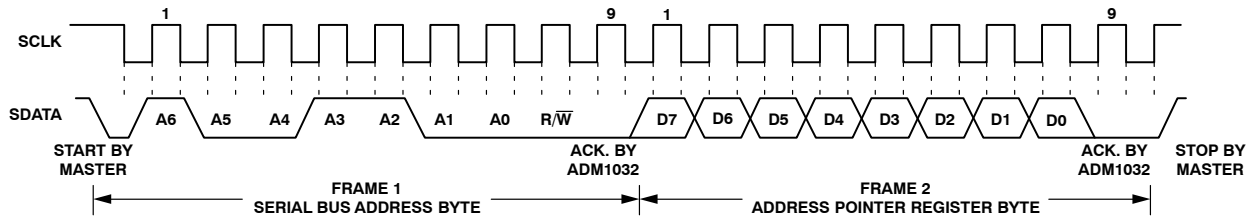

Figure 14. Writing to the Address Pointer Register Only

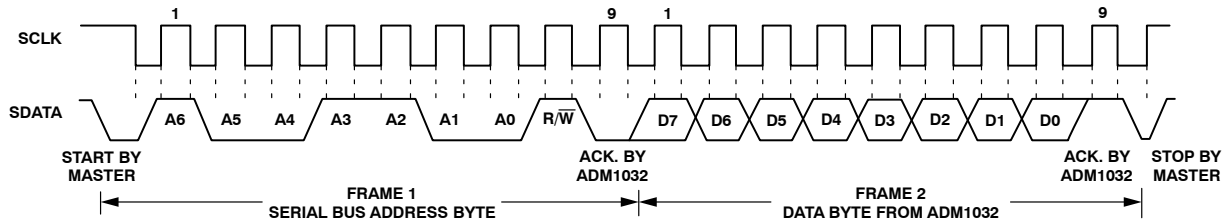

Figure 15. Reading Data from a Previously Selected Register

## ALERT Output

The  $\overline{\text{ALERT}}$  output goes low whenever an out-of-limit measurement is detected, or if the remote temperature sensor is open-circuit. It is an open drain and requires a pullup to  $V_{\text{DD}}$ . Several  $\overline{\text{ALERT}}$  outputs can be wire-OR'ed together so that the common line goes low if one or more of the  $\overline{\text{ALERT}}$  outputs goes low.

The  $\overline{\text{ALERT}}$  output can be used as an interrupt signal to a processor, or it can be used as an  $\overline{\text{SMBALERT}}$ . Slave devices on the SMBus can not normally signal to the master that they want to talk, but the  $\overline{\text{SMBALERT}}$  function allows them to do so.

One or more  $\overline{\text{ALERT}}$  outputs can be connected to a common  $\overline{\text{SMBALERT}}$  line connected to the master. When the  $\overline{\text{SMBALERT}}$  line is pulled low by one of the devices, the following procedure occurs (see Figure 16).

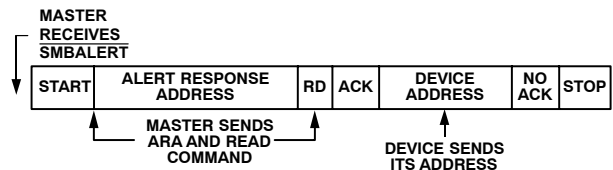

Figure 16. Use of  $\overline{\text{SMBALERT}}$

1.  $\overline{\text{SMBALERT}}$  is pulled low.
2. Master initiates a read operation and sends the alert response address (ARA = 0001 100). This is a general call address that must not be used as a specific device address.
3. The device whose  $\overline{\text{ALERT}}$  output is low responds to the alert response address and the master reads its device address. Since the device address is

seven bits, an LSB of 1 is added. The address of the device is now known, and it can be interrogated in the usual way.

- If more than one device's  $\overline{\text{ALERT}}$  output is low, the one with the lowest device address has priority in accordance with normal SMBus arbitration.
- Once the ADM1032 has responded to the alert response address, it resets its  $\overline{\text{ALERT}}$  output, provided that the error condition that caused the  $\overline{\text{ALERT}}$  no longer exists. If the  $\overline{\text{SMBALERT}}$  line remains low, the master sends ARA again, and so on until all devices whose  $\overline{\text{ALERT}}$  outputs were low have responded.

### Low Power Standby Mode

The ADM1032 can be put into a low power standby mode by setting Bit 6 of the configuration register. When Bit 6 is low, the ADM1032 operates normally. When Bit 6 is high, the ADC is inhibited and any conversion in progress is terminated without writing the result to the corresponding value register.

The SMBus is still enabled. Power consumption in the standby mode is reduced to less than 10  $\mu\text{A}$  if there is no SMBus activity, or 100  $\mu\text{A}$  if there are clock and data signals on the bus.

When the device is in standby mode, it is still possible to initiate a one-shot conversion of both channels by writing XXh to the one-shot register (Address 0Fh), after which the device returns to standby. It is also possible to write new values to the limit register while it is in standby. If the values stored in the temperature value registers are now outside the new limits, an  $\overline{\text{ALERT}}$  is generated even though the ADM1032 is still in standby.

### The ADM1032 Interrupt System

The ADM1032 has two interrupt outputs,  $\overline{\text{ALERT}}$  and  $\overline{\text{THERM}}$ . These have different functions.  $\overline{\text{ALERT}}$  responds to violations of software-programmed temperature limits and is maskable.  $\overline{\text{THERM}}$  is intended as a fail-safe interrupt output that cannot be masked.

If the temperature goes equal to or below the lower temperature limit, the  $\overline{\text{ALERT}}$  pin is asserted low to indicate an out-of-limit condition. If the temperature is within the programmed low and high temperature limits, no interrupt is generated.

If the temperature exceeds the high temperature limit, the  $\overline{\text{ALERT}}$  pin is asserted low to indicate an overtemperature condition. A local and remote  $\overline{\text{THERM}}$  limit can be programmed into the device to set the temperature limit above which the overtemperature  $\overline{\text{THERM}}$  pin is asserted low. This temperature limit should be equal to or greater than the high temperature limit programmed.

The behavior of the high limit and  $\overline{\text{THERM}}$  limit is as follows:

- If either temperature measured exceeds the high temperature limit, the  $\overline{\text{ALERT}}$  output is asserted low.

- If the local or remote temperature continues to increase and either one exceeds the  $\overline{\text{THERM}}$  limit, the  $\overline{\text{THERM}}$  output asserts low. This can be used to throttle the CPU clock or switch on a fan.

A  $\overline{\text{THERM}}$  hysteresis value is provided to prevent a cooling fan cycling on and off. The power-on default value is 10°C, but this can be reprogrammed to any value after powerup. This hysteresis value applies to both the local and remote channels.

Using these two limits in this way, allows the user to gain maximum performance from the system by only slowing it down should it be at a critical temperature.

The  $\overline{\text{THERM}}$  signal is open drain and requires a pullup to  $V_{\text{DD}}$ . The  $\overline{\text{THERM}}$  signal must always be pulled up to the same power supply as the ADM1032, unlike the SMBus signals (SDATA, SCLK, and  $\overline{\text{ALERT}}$ ) that can be pulled to a different power rail, usually that of the SMBus controller.

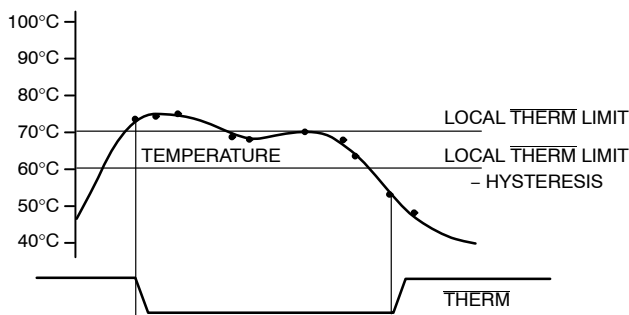

Figure 17. Operation of the  $\overline{\text{THERM}}$  Output

Table 13.  $\overline{\text{THERM}}$  HYSTERESIS SAMPLE VALUES

$\overline{\text{THERM}}$ Hysteresis	Binary Representation
0°C	0 000 0000
1°C	0 000 0001
10°C	0 000 1010

### Sensor Fault Detection

At the D+ input, the ADM1032 has a fault detector that detects if the external sensor diode is open circuit. This is a simple voltage comparator that trips if the voltage at D+ exceeds  $V_{\text{DD}} - 1.0\text{ V}$  (typical). The output of this comparator is checked when a conversion is initiated and sets Bit 2 of the status register if a fault is detected.

If the remote sensor voltage falls below the normal measuring range, for example, due to the diode being short-circuited, the ADC outputs -128 (1000 0000). Since the normal operating temperature range of the device only extends down to 0°C, this output code should never be seen in normal operation, so it can be interpreted as a fault condition. Since it is outside the power-on default low temperature limit (0°C) and any low limit that would normally be programmed, a short-circuit sensor causes an SMBus alert.

In this respect, the ADM1032 differs from and improves upon competitive devices that output zero if the external sensor goes short-circuit. These devices can misinterpret a genuine 0°C measurement as a fault condition.

When the D+ and D– lines are shorted together, an **ALERT** is always generated. This is because the remote value register reports a temperature value of –128°C. Since the ADM1032 performs a less-than or equal-to comparison with the low limit, an **ALERT** is generated even when the low limit is set to its minimum of –128°C.

## Applications Information – Factors Affecting Accuracy

### Remote Sensing Diode

The ADM1032 is designed to work with substrate transistors built into processors' CPUs or with discrete transistors. Substrate transistors are generally PNP types with the collector connected to the substrate. Discrete types can be either a PNP or an NPN transistor connected as a diode (base shorted to collector). If an NPN transistor is used, the collector and base are connected to D+ and the emitter to D–. If a PNP transistor is used, the collector and base are connected to D– and the emitter to D+. Substrate transistors are found in a number of CPUs. To reduce the error due to variations in these substrate and discrete transistors, a number of factors should be taken into consideration:

1. The ideality factor,  $n_f$ , of the transistor. The ideality factor is a measure of the deviation of the thermal diode from the ideal behavior. The ADM1032 is trimmed for an  $n_f$  value of 1.008. The following equation can be used to calculate the error introduced at a temperature T°C when using a transistor whose  $n_f$  does not equal 1.008. Consult the processor data sheet for  $n_f$  values.

$$\Delta T = \frac{(n_{\text{natural}} - 1.008)}{1.008} \times (273.15 \text{ Kelvin} + T) \quad (\text{eq. 2})$$

This value can be written to the offset register and is automatically added to or subtracted from the temperature measurement.

2. Some CPU manufacturers specify the high and low current levels of the substrate transistors. The high current level of the ADM1032,  $I_{\text{HIGH}}$ , is 230  $\mu\text{A}$  and the low level current,  $I_{\text{LOW}}$ , is 13  $\mu\text{A}$ . If the ADM1032 current levels do not match the levels of the CPU manufacturers, then it can become necessary to remove an offset. The CPU's data sheet advises whether this offset needs to be removed and how to calculate it. This offset can be programmed to the offset register. It is important to note that if accounting for two or more offsets is needed, then the algebraic sum of these offsets must be programmed to the offset register.

If a discrete transistor is being used with the ADM1032, the best accuracy is obtained by choosing devices according to the following criteria:

- Base-emitter Voltage Greater than 0.25 V at 6 mA, at the Highest Operating Temperature
- Base-emitter Voltage Less than 0.95 V at 100 mA, at the Lowest Operating Temperature
- Base Resistance Less than 100  $\Omega$
- Small Variation in  $h_{\text{FE}}$  (say 50 to 150) that Indicates Tight Control of  $V_{\text{BE}}$  Characteristics

Transistors such as 2N3904, 2N3906, or equivalents in SOT–23 packages are suitable devices to use.

### Thermal Inertia and Self-heating

Accuracy depends on the temperature of the remote-sensing diode and/or the internal temperature sensor being at the same temperature as that being measured, and a number of factors can affect this. Ideally, the sensor should be in good thermal contact with the part of the system being measured, for example, the processor. If it is not, the thermal inertia caused by the mass of the sensor causes a lag in the response of the sensor to a temperature change. In the case of the remote sensor, this should not be a problem, since it is either a substrate transistor in the processor or a small package device, such as the SOT–23, placed in close proximity to it.

The on-chip sensor, however, is often remote from the processor and is only monitoring the general ambient temperature around the package. The thermal time constant of the SOIC–8 package in still air is about 140 seconds, and if the ambient air temperature quickly changed by 100°, it would take about 12 minutes (five time constants) for the junction temperature of the ADM1032 to settle within 1° of this. In practice, the ADM1032 package is in electrical and therefore thermal contact with a printed circuit board and can also be in a forced airflow. How accurately the temperature of the board and/or the forced airflow reflect the temperature to be measured also affects the accuracy.

Self-heating due to the power dissipated in the ADM1032 or the remote sensor causes the chip temperature of the device or remote sensor to rise above ambient. However, the current forced through the remote sensor is so small that self-heating is negligible. In the case of the ADM1032, the worst-case condition occurs when the device is converting at 16 conversions per second while sinking the maximum current of 1 mA at the **ALERT** and **THERM** output. In this case, the total power dissipation in the device is about 11 mW. The thermal resistance,  $\theta_{\text{JA}}$ , of the SOIC–8 package is about 121°C/W.

In practice, the package has electrical and therefore thermal connection to the printed circuit board, so the temperature rise due to self-heating is negligible.

### Layout Considerations

Digital boards can be electrically noisy environments, and the ADM1032 is measuring very small voltages from the remote sensor, so care must be taken to minimize noise induced at the sensor inputs. The following precautions should be taken.

1. Place the ADM1032 as close as possible to the remote sensing diode. Provided that the worst noise sources, that is, clock generators, data/address buses, and CRTs, are avoided, this distance can be four to eight inches.
2. Route the D+ and D- tracks close together, in parallel, with grounded guard tracks on each side. Provide a ground plane under the tracks if possible.
3. Use wide tracks to minimize inductance and reduce noise pickup. 10 mil track minimum width and spacing is recommended.



**Figure 18. Typical Arrangement of Signal Tracks**

4. Try to minimize the number of copper/solder joints, which can cause thermocouple effects. Where copper/solder joints are used, make sure that they are in both the D+ and D- path and at the same temperature. Thermocouple effects should not be a major problem since 1°C corresponds to about 200  $\mu\text{V}$  and thermocouple voltages are about 3  $\mu\text{V}/^\circ\text{C}$  of temperature difference. Unless there are two thermocouples with a big temperature differential between them, thermocouple voltages should be much less than 200  $\mu\text{V}$ .
5. Place a 0.1  $\mu\text{F}$  bypass capacitor close to the  $V_{\text{DD}}$  pin. In very noisy environments, place a 1000 pF input filter capacitor across D+ and D- close to the ADM1032.

6. If the distance to the remote sensor is more than eight inches, the use of twisted pair cable is recommended. This works up to about 6 feet to 12 feet.
7. For really long distances (up to 100 feet), use shielded twisted pair, such as Belden #8451 microphone cable. Connect the twisted pair to D+ and D- and the shield to GND close to the ADM1032. Leave the remote end of the shield unconnected to avoid ground loops.

Because the measurement technique uses switched current sources, excessive cable and/or filter capacitance can affect the measurement. When using long cables, the filter capacitor can be reduced or removed.

Cable resistance can also introduce errors. 1  $\Omega$  series resistance introduces about 1°C error.

### Power Sequencing Considerations

#### Power Supply Slew Rate

When powering up the ADM1032 you must ensure that the slew rate of  $V_{\text{DD}}$  is less than 18 mV/ $\mu\text{s}$ . A slew rate larger than this may cause power-on-reset issues and yield unpredictable results.

#### THERM Pin Pullup

As mentioned above, the  $\overline{\text{THERM}}$  signal is open drain and requires a pullup to  $V_{\text{DD}}$ . The  $\overline{\text{THERM}}$  signal must always be pulled up to the same power supply as the ADM1032, unlike the SMBus signals (SDA, SCL and  $\overline{\text{ALERT}}$ ) that can be pulled to a different power rail. The only time the  $\overline{\text{THERM}}$  pin can be pulled to a different supply rail (other than  $V_{\text{DD}}$ ) is if the other supply is powered up simultaneously with, or after the ADM1032 main  $V_{\text{DD}}$ . This is to protect the internal circuitry of the ADM1032. If the  $\overline{\text{THERM}}$  pullup supply rail were to rise before  $V_{\text{DD}}$ , the POR circuitry may not operate correctly.

#### Application Circuit

Figure 19 shows a typical application circuit for the ADM1032, using a discrete sensor transistor connected via a shielded, twisted pair cable. The pullups on SCLK, SDATA, and  $\overline{\text{ALERT}}$  are required only if they are not already provided elsewhere in the system.

The SCLK and SDATA pins of the ADM1032 can be interfaced directly to the SMBus of an I/O controller, such as the Intel 820 chipset.

## ADM1032

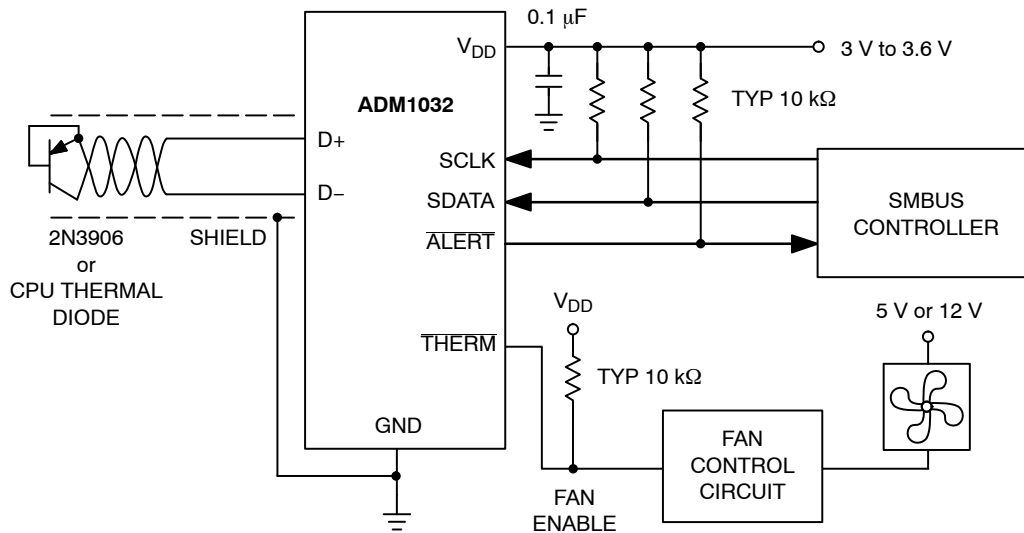

**Figure 19. Typical Application Circuit**

**Table 14. ORDERING INFORMATION**

Device Order Number*	Package Description	Package Option	Part Marking	SMBus Address	Shipping <sup>†</sup>	External THERM Default
ADM1032ARZ-REEL	8-lead SOIC NB	R-8	#1	4C	2,500 Tape & Reel	85°C
ADM1032ARZ-1REEL	8-lead SOIC NB	R-8	#2	4C	2,500 Tape & Reel	108°C
ADM1032ARMZ-REEL	8-lead MSOP	RM-8	T1J	4C	3,000 Tape & Reel	85°C
ADM1032ARMZ-1RL	8-lead MSOP	RM-8	T13	4C	3,000 Tape & Reel	108°C
ADM1032ARMZ-2R	8-lead MSOP	RM-8	T1C	4D	3,000 Tape & Reel	85°C

\*The "Z" suffix indicates Pb-Free package.

†For information on tape and reel specifications, including part orientation and tape sizes, please refer to our Tape and Reel Packaging Specifications Brochure, BRD8011/D.



# MECHANICAL CASE OUTLINE PACKAGE DIMENSIONS



SCALE 1:1

SOIC-8 NB  
CASE 751-07  
ISSUE AK

DATE 16 FEB 2011



- NOTES:
1. DIMENSIONING AND TOLERANCING PER ANSI Y14.5M, 1982.
  2. CONTROLLING DIMENSION: MILLIMETER.
  3. DIMENSION A AND B DO NOT INCLUDE MOLD PROTRUSION.
  4. MAXIMUM MOLD PROTRUSION 0.15 (0.006) PER SIDE.
  5. DIMENSION D DOES NOT INCLUDE DAMBAR PROTRUSION. ALLOWABLE DAMBAR PROTRUSION SHALL BE 0.127 (0.005) TOTAL IN EXCESS OF THE D DIMENSION AT MAXIMUM MATERIAL CONDITION.
  6. 751-01 THRU 751-06 ARE OBSOLETE. NEW STANDARD IS 751-07.

DIM	MILLIMETERS		INCHES	
	MIN	MAX	MIN	MAX
A	4.80	5.00	0.189	0.197
B	3.80	4.00	0.150	0.157
C	1.35	1.75	0.053	0.069
D	0.33	0.51	0.013	0.020
G	1.27 BSC		0.050 BSC	
H	0.10	0.25	0.004	0.010
J	0.19	0.25	0.007	0.010
K	0.40	1.27	0.016	0.050
M	0°	8°	0°	8°
N	0.25	0.50	0.010	0.020
S	5.80	6.20	0.228	0.244

## GENERIC MARKING DIAGRAM\*

### SOLDERING FOOTPRINT\*

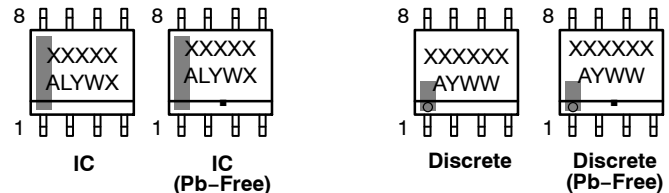
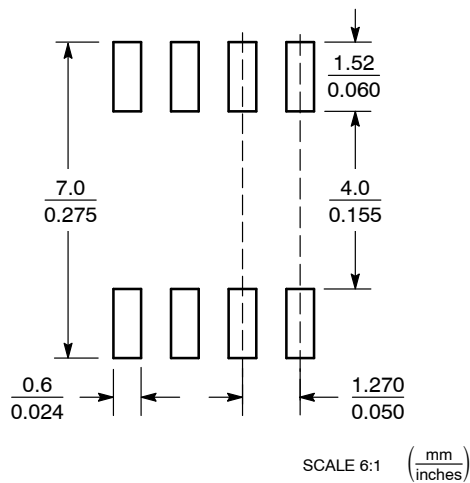

XXXXX = Specific Device Code  
A = Assembly Location  
L = Wafer Lot  
Y = Year  
W = Work Week  
▪ = Pb-Free Package

XXXXXX = Specific Device Code  
A = Assembly Location  
Y = Year  
WW = Work Week  
▪ = Pb-Free Package

\*This information is generic. Please refer to device data sheet for actual part marking. Pb-Free indicator, "G" or microdot "▪", may or may not be present. Some products may not follow the Generic Marking.

\*For additional information on our Pb-Free strategy and soldering details, please download the ON Semiconductor Soldering and Mounting Techniques Reference Manual, SOLDERRM/D.

## STYLES ON PAGE 2

DOCUMENT NUMBER:	98ASB42564B	Electronic versions are uncontrolled except when accessed directly from the Document Repository. Printed versions are uncontrolled except when stamped "CONTROLLED COPY" in red.
DESCRIPTION:	SOIC-8 NB	PAGE 1 OF 2

onsemi and ONSEMI are trademarks of Semiconductor Components Industries, LLC dba onsemi or its subsidiaries in the United States and/or other countries. onsemi reserves the right to make changes without further notice to any products herein. onsemi makes no warranty, representation or guarantee regarding the suitability of its products for any particular purpose, nor does onsemi assume any liability arising out of the application or use of any product or circuit, and specifically disclaims any and all liability, including without limitation special, consequential or incidental damages. onsemi does not convey any license under its patent rights nor the rights of others.

**SOIC-8 NB**  
**CASE 751-07**  
**ISSUE AK**

DATE 16 FEB 2011

- |  |   |   |   |
|--|---|---|---|
| <p><b>STYLE 1:</b><br/>         PIN 1. EMITTER<br/>         2. COLLECTOR<br/>         3. COLLECTOR<br/>         4. EMITTER<br/>         5. EMITTER<br/>         6. BASE<br/>         7. BASE<br/>         8. EMITTER</p>   | <p><b>STYLE 2:</b><br/>         PIN 1. COLLECTOR, DIE, #1<br/>         2. COLLECTOR, #1<br/>         3. COLLECTOR, #2<br/>         4. COLLECTOR, #2<br/>         5. BASE, #2<br/>         6. EMITTER, #2<br/>         7. BASE, #1<br/>         8. EMITTER, #1</p>               | <p><b>STYLE 3:</b><br/>         PIN 1. DRAIN, DIE #1<br/>         2. DRAIN, #1<br/>         3. DRAIN, #2<br/>         4. DRAIN, #2<br/>         5. GATE, #2<br/>         6. SOURCE, #2<br/>         7. GATE, #1<br/>         8. SOURCE, #1</p>                            | <p><b>STYLE 4:</b><br/>         PIN 1. ANODE<br/>         2. ANODE<br/>         3. ANODE<br/>         4. ANODE<br/>         5. ANODE<br/>         6. ANODE<br/>         7. ANODE<br/>         8. COMMON CATHODE</p>   |
| <p><b>STYLE 5:</b><br/>         PIN 1. DRAIN<br/>         2. DRAIN<br/>         3. DRAIN<br/>         4. DRAIN<br/>         5. GATE<br/>         6. GATE<br/>         7. SOURCE<br/>         8. SOURCE</p>   | <p><b>STYLE 6:</b><br/>         PIN 1. SOURCE<br/>         2. DRAIN<br/>         3. DRAIN<br/>         4. SOURCE<br/>         5. SOURCE<br/>         6. GATE<br/>         7. GATE<br/>         8. SOURCE</p>  | <p><b>STYLE 7:</b><br/>         PIN 1. INPUT<br/>         2. EXTERNAL BYPASS<br/>         3. THIRD STAGE SOURCE<br/>         4. GROUND<br/>         5. DRAIN<br/>         6. GATE 3<br/>         7. SECOND STAGE Vd<br/>         8. FIRST STAGE Vd</p>                    | <p><b>STYLE 8:</b><br/>         PIN 1. COLLECTOR, DIE #1<br/>         2. BASE, #1<br/>         3. BASE, #2<br/>         4. COLLECTOR, #2<br/>         5. COLLECTOR, #2<br/>         6. EMITTER, #2<br/>         7. EMITTER, #1<br/>         8. COLLECTOR, #1</p>                              |
| <p><b>STYLE 9:</b><br/>         PIN 1. EMITTER, COMMON<br/>         2. COLLECTOR, DIE #1<br/>         3. COLLECTOR, DIE #2<br/>         4. EMITTER, COMMON<br/>         5. EMITTER, COMMON<br/>         6. BASE, DIE #2<br/>         7. BASE, DIE #1<br/>         8. EMITTER, COMMON</p> | <p><b>STYLE 10:</b><br/>         PIN 1. GROUND<br/>         2. BIAS 1<br/>         3. OUTPUT<br/>         4. GROUND<br/>         5. GROUND<br/>         6. BIAS 2<br/>         7. INPUT<br/>         8. GROUND</p>  | <p><b>STYLE 11:</b><br/>         PIN 1. SOURCE 1<br/>         2. GATE 1<br/>         3. SOURCE 2<br/>         4. GATE 2<br/>         5. DRAIN 2<br/>         6. DRAIN 2<br/>         7. DRAIN 1<br/>         8. DRAIN 1</p>   | <p><b>STYLE 12:</b><br/>         PIN 1. SOURCE<br/>         2. SOURCE<br/>         3. SOURCE<br/>         4. GATE<br/>         5. DRAIN<br/>         6. DRAIN<br/>         7. DRAIN<br/>         8. DRAIN</p>   |
| <p><b>STYLE 13:</b><br/>         PIN 1. N.C.<br/>         2. SOURCE<br/>         3. SOURCE<br/>         4. GATE<br/>         5. DRAIN<br/>         6. DRAIN<br/>         7. DRAIN<br/>         8. DRAIN</p>  | <p><b>STYLE 14:</b><br/>         PIN 1. N-SOURCE<br/>         2. N-GATE<br/>         3. P-SOURCE<br/>         4. P-GATE<br/>         5. P-DRAIN<br/>         6. P-DRAIN<br/>         7. N-DRAIN<br/>         8. N-DRAIN</p>   | <p><b>STYLE 15:</b><br/>         PIN 1. ANODE 1<br/>         2. ANODE 1<br/>         3. ANODE 1<br/>         4. ANODE 1<br/>         5. CATHODE, COMMON<br/>         6. CATHODE, COMMON<br/>         7. CATHODE, COMMON<br/>         8. CATHODE, COMMON</p>               | <p><b>STYLE 16:</b><br/>         PIN 1. EMITTER, DIE #1<br/>         2. BASE, DIE #1<br/>         3. EMITTER, DIE #2<br/>         4. BASE, DIE #2<br/>         5. COLLECTOR, DIE #2<br/>         6. COLLECTOR, DIE #2<br/>         7. COLLECTOR, DIE #1<br/>         8. COLLECTOR, DIE #1</p> |
| <p><b>STYLE 17:</b><br/>         PIN 1. VCC<br/>         2. V2OUT<br/>         3. V1OUT<br/>         4. TXE<br/>         5. RXE<br/>         6. VEE<br/>         7. GND<br/>         8. ACC</p>  | <p><b>STYLE 18:</b><br/>         PIN 1. ANODE<br/>         2. ANODE<br/>         3. SOURCE<br/>         4. GATE<br/>         5. DRAIN<br/>         6. DRAIN<br/>         7. CATHODE<br/>         8. CATHODE</p>   | <p><b>STYLE 19:</b><br/>         PIN 1. SOURCE 1<br/>         2. GATE 1<br/>         3. SOURCE 2<br/>         4. GATE 2<br/>         5. DRAIN 2<br/>         6. MIRROR 2<br/>         7. DRAIN 1<br/>         8. MIRROR 1</p>   | <p><b>STYLE 20:</b><br/>         PIN 1. SOURCE (N)<br/>         2. GATE (N)<br/>         3. SOURCE (P)<br/>         4. GATE (P)<br/>         5. DRAIN<br/>         6. DRAIN<br/>         7. DRAIN<br/>         8. DRAIN</p>   |
| <p><b>STYLE 21:</b><br/>         PIN 1. CATHODE 1<br/>         2. CATHODE 2<br/>         3. CATHODE 3<br/>         4. CATHODE 4<br/>         5. CATHODE 5<br/>         6. COMMON ANODE<br/>         7. COMMON ANODE<br/>         8. CATHODE 6</p>  | <p><b>STYLE 22:</b><br/>         PIN 1. I/O LINE 1<br/>         2. COMMON CATHODE/VCC<br/>         3. COMMON CATHODE/VCC<br/>         4. I/O LINE 3<br/>         5. COMMON ANODE/GND<br/>         6. I/O LINE 4<br/>         7. I/O LINE 5<br/>         8. COMMON ANODE/GND</p> | <p><b>STYLE 23:</b><br/>         PIN 1. LINE 1 IN<br/>         2. COMMON ANODE/GND<br/>         3. COMMON ANODE/GND<br/>         4. LINE 2 IN<br/>         5. LINE 2 OUT<br/>         6. COMMON ANODE/GND<br/>         7. COMMON ANODE/GND<br/>         8. LINE 1 OUT</p> | <p><b>STYLE 24:</b><br/>         PIN 1. BASE<br/>         2. EMITTER<br/>         3. COLLECTOR/ANODE<br/>         4. COLLECTOR/ANODE<br/>         5. CATHODE<br/>         6. CATHODE<br/>         7. COLLECTOR/ANODE<br/>         8. COLLECTOR/ANODE</p>                                      |
| <p><b>STYLE 25:</b><br/>         PIN 1. VIN<br/>         2. N/C<br/>         3. REXT<br/>         4. GND<br/>         5. IOUT<br/>         6. IOUT<br/>         7. IOUT<br/>         8. IOUT</p>   | <p><b>STYLE 26:</b><br/>         PIN 1. GND<br/>         2. dv/dt<br/>         3. ENABLE<br/>         4. ILIMIT<br/>         5. SOURCE<br/>         6. SOURCE<br/>         7. SOURCE<br/>         8. VCC</p>  | <p><b>STYLE 27:</b><br/>         PIN 1. ILIMIT<br/>         2. OVLO<br/>         3. UVLO<br/>         4. INPUT+<br/>         5. SOURCE<br/>         6. SOURCE<br/>         7. SOURCE<br/>         8. DRAIN</p>  | <p><b>STYLE 28:</b><br/>         PIN 1. SW_TO_GND<br/>         2. DASIC OFF<br/>         3. DASIC_SW_DET<br/>         4. GND<br/>         5. V_MON<br/>         6. VBULK<br/>         7. VBULK<br/>         8. VIN</p>  |
| <p><b>STYLE 29:</b><br/>         PIN 1. BASE, DIE #1<br/>         2. EMITTER, #1<br/>         3. BASE, #2<br/>         4. EMITTER, #2<br/>         5. COLLECTOR, #2<br/>         6. COLLECTOR, #2<br/>         7. COLLECTOR, #1<br/>         8. COLLECTOR, #1</p>                        | <p><b>STYLE 30:</b><br/>         PIN 1. DRAIN 1<br/>         2. DRAIN 1<br/>         3. GATE 2<br/>         4. SOURCE 2<br/>         5. SOURCE 1/DRAIN 2<br/>         6. SOURCE 1/DRAIN 2<br/>         7. SOURCE 1/DRAIN 2<br/>         8. GATE 1</p>                           |   |   |

<b>DOCUMENT NUMBER:</b>	<b>98ASB42564B</b>	Electronic versions are uncontrolled except when accessed directly from the Document Repository. Printed versions are uncontrolled except when stamped "CONTROLLED COPY" in red.
<b>DESCRIPTION:</b>	<b>SOIC-8 NB</b>	<b>PAGE 2 OF 2</b>

**onsemi** and **ONSEMI** are trademarks of Semiconductor Components Industries, LLC dba **onsemi** or its subsidiaries in the United States and/or other countries. **onsemi** reserves the right to make changes without further notice to any products herein. **onsemi** makes no warranty, representation or guarantee regarding the suitability of its products for any particular purpose, nor does **onsemi** assume any liability arising out of the application or use of any product or circuit, and specifically disclaims any and all liability, including without limitation special, consequential or incidental damages. **onsemi** does not convey any license under its patent rights nor the rights of others.

# MECHANICAL CASE OUTLINE

## PACKAGE DIMENSIONS

ON Semiconductor®



SCALE 2:1

### Micro8 CASE 846A-02 ISSUE K

DATE 16 JUL 2020

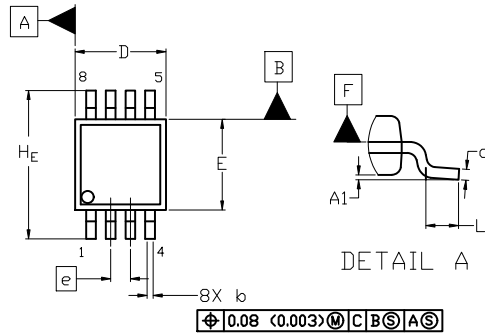

TOP VIEW

NOTE 3

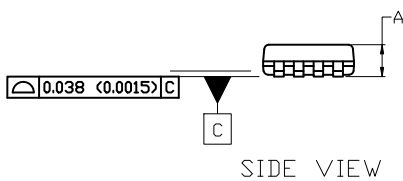

SIDE VIEW

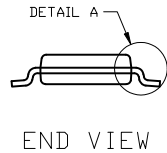

END VIEW

#### GENERIC MARKING DIAGRAM\*

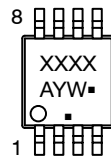

- XXXX = Specific Device Code
- A = Assembly Location
- Y = Year
- W = Work Week
- = Pb-Free Package

(Note: Microdot may be in either location)

\*This information is generic. Please refer to device data sheet for actual part marking. Pb-Free indicator, "G" or microdot "▪", may or may not be present. Some products may not follow the Generic Marking.

#### NOTES:

1. DIMENSIONING AND TOLERANCING PER ASME Y14.5M, 2009.
2. CONTROLLING DIMENSION: MILLIMETERS
3. DIMENSION *b* DOES NOT INCLUDE DAMBAR PROTRUSION. ALLOWABLE PROTRUSION SHALL BE 0.10 mm IN EXCESS OF MAXIMUM MATERIAL CONDITION.
4. DIMENSIONS *D* AND *E* DO NOT INCLUDE MOLD FLASH, PROTRUSION OR GATE BURRS. MOLD FLASH, PROTRUSIONS, OR GATE BURRS SHALL NOT EXCEED 0.15 mm PER SIDE. DIMENSION *E* DOES NOT INCLUDE INTERLEAD FLASH OR PROTRUSION. INTERLEAD FLASH OR PROTRUSION SHALL NOT EXCEED 0.25 mm PER SIDE. DIMENSIONS *D* AND *E* ARE DETERMINED AT DATUM *F*.
5. DATUMS *A* AND *B* ARE TO BE DETERMINED AT DATUM *F*.
6. *A1* IS DEFINED AS THE VERTICAL DISTANCE FROM THE SEATING PLANE TO THE LOWEST POINT ON THE PACKAGE BODY.

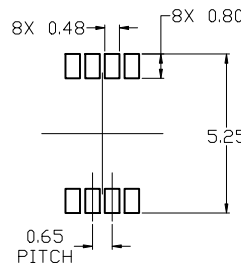

#### RECOMMENDED MOUNTING FOOTPRINT

For additional information on our Pb-Free strategy and soldering details, please download the ON Semiconductor Soldering and Mounting Techniques Reference Manual, SOLDERM/D.

DIM	MILLIMETERS		
	MIN.	NOM.	MAX.
A	---	---	1.10
A1	0.05	0.08	0.15
<i>b</i>	0.25	0.33	0.40
<i>c</i>	0.13	0.18	0.23
<i>D</i>	2.90	3.00	3.10
<i>E</i>	2.90	3.00	3.10
<i>e</i>	0.65 BSC		
<i>H<sub>E</sub></i>	4.75	4.90	5.05
<i>L</i>	0.40	0.55	0.70

#### STYLE 1:

- PIN 1. SOURCE
2. SOURCE
3. SOURCE
4. GATE
5. DRAIN
6. DRAIN
7. DRAIN
8. DRAIN

#### STYLE 2:

- PIN 1. SOURCE 1
2. GATE 1
3. SOURCE 2
4. GATE 2
5. DRAIN 2
6. DRAIN 2
7. DRAIN 1
8. DRAIN 1

#### STYLE 3:

- PIN 1. N-SOURCE
2. N-GATE
3. P-SOURCE
4. P-GATE
5. P-DRAIN
6. P-DRAIN
7. N-DRAIN
8. N-DRAIN

<b>DOCUMENT NUMBER:</b>	<b>98ASB14087C</b>	Electronic versions are uncontrolled except when accessed directly from the Document Repository. Printed versions are uncontrolled except when stamped "CONTROLLED COPY" in red.
<b>DESCRIPTION:</b>	<b>MICRO8</b>	<b>PAGE 1 OF 1</b>

ON Semiconductor and are trademarks of Semiconductor Components Industries, LLC dba ON Semiconductor or its subsidiaries in the United States and/or other countries. ON Semiconductor reserves the right to make changes without further notice to any products herein. ON Semiconductor makes no warranty, representation or guarantee regarding the suitability of its products for any particular purpose, nor does ON Semiconductor assume any liability arising out of the application or use of any product or circuit, and specifically disclaims any and all liability, including without limitation special, consequential or incidental damages. ON Semiconductor does not convey any license under its patent rights nor the rights of others.

**onsemi**, **Onsemi**, and other names, marks, and brands are registered and/or common law trademarks of Semiconductor Components Industries, LLC dba "**onsemi**" or its affiliates and/or subsidiaries in the United States and/or other countries. **onsemi** owns the rights to a number of patents, trademarks, copyrights, trade secrets, and other intellectual property. A listing of **onsemi**'s product/patent coverage may be accessed at [www.onsemi.com/site/pdf/Patent-Marking.pdf](http://www.onsemi.com/site/pdf/Patent-Marking.pdf). **onsemi** reserves the right to make changes at any time to any products or information herein, without notice. The information herein is provided "as-is" and **onsemi** makes no warranty, representation or guarantee regarding the accuracy of the information, product features, availability, functionality, or suitability of its products for any particular purpose, nor does **onsemi** assume any liability arising out of the application or use of any product or circuit, and specifically disclaims any and all liability, including without limitation special, consequential or incidental damages. Buyer is responsible for its products and applications using **onsemi** products, including compliance with all laws, regulations and safety requirements or standards, regardless of any support or applications information provided by **onsemi**. "Typical" parameters which may be provided in **onsemi** data sheets and/or specifications can and do vary in different applications and actual performance may vary over time. All operating parameters, including "Typicals" must be validated for each customer application by customer's technical experts. **onsemi** does not convey any license under any of its intellectual property rights nor the rights of others. **onsemi** products are not designed, intended, or authorized for use as a critical component in life support systems or any FDA Class 3 medical devices or medical devices with a same or similar classification in a foreign jurisdiction or any devices intended for implantation in the human body. Should Buyer purchase or use **onsemi** products for any such unintended or unauthorized application, Buyer shall indemnify and hold **onsemi** and its officers, employees, subsidiaries, affiliates, and distributors harmless against all claims, costs, damages, and expenses, and reasonable attorney fees arising out of, directly or indirectly, any claim of personal injury or death associated with such unintended or unauthorized use, even if such claim alleges that **onsemi** was negligent regarding the design or manufacture of the part. **onsemi** is an Equal Opportunity/Affirmative Action Employer. This literature is subject to all applicable copyright laws and is not for resale in any manner.

## PUBLICATION ORDERING INFORMATION

### LITERATURE FULFILLMENT:

Email Requests to: [orderlit@onsemi.com](mailto:orderlit@onsemi.com)

**onsemi Website:** [www.onsemi.com](http://www.onsemi.com)

### TECHNICAL SUPPORT

**North American Technical Support:**

Voice Mail: 1 800-282-9855 Toll Free USA/Canada

Phone: 011 421 33 790 2910

**Europe, Middle East and Africa Technical Support:**

Phone: 00421 33 790 2910

For additional information, please contact your local Sales Representative

