

1500 W TVS in SMB Flat

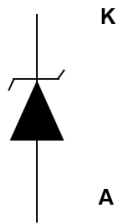
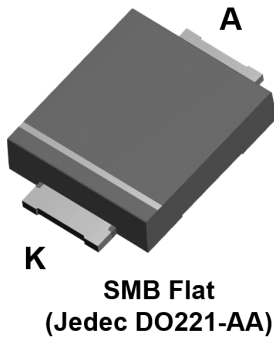

Unidirectional

Product status link

SMB15FxxA series

SMB15F5.0A, SMB15F6.0A,
SMB15F6.5A, SMB15F8.5A,
SMB15F10A, SMB15F11A, SMB15F13A,
SMB15F12A, SMB15F14A, SMB15F15A,
SMB15F16A, SMB15F18A, SMB15F20A,
SMB15F22A, SMB15F23A, SMB15F24A,
SMB15F26A, SMB15F28A, SMB15F30A,
SMB15F31A, SMB15F33A, SMB15F36A,
SMB15F40A, SMB15F48A, SMB15F58A,
SMB15F64A

Features

- Peak pulse power: 1500 W (10/1000 μ s) and 10 kW (8/20 μ s)
- Flat and thin package: 1 mm
- Stand-off voltage range: from 5 V to 64 V
- Unidirectional type
- Low leakage current: 0.2 μ A at 25 °C and 1 μ A at 85 °C
- Operating T_j max: 175 °C
- High power capability at T_j max.: 1100 W (10/1000 μ s)
- Lead finishing: matte tin plating

Complies with the following standards

- UL94, V0
- J-STD-020 MSL level 1
- J-STD-002, JESD 22-B102 E3 and MIL-STD-750, method 2026 solderable matte tin plated leads
- JESD-201 class 2 whisker test
- IPC7531 footprint
- JEDEC registered package outline
- IEC 61000-4-4 level 4:
 - 4 kV
- IEC 61000-4-2, C = 150 pF - R = 330 Ω exceeds level 4:
 - 30 kV (air discharge)
 - 30 kV (contact discharge)

Description

The SMB15FxxA series are designed to protect sensitive circuits against surges.

The Planar technology makes it compatible with high-end circuits where low leakage current and high junction temperature are required to provide long term reliability and stability.

1 Characteristics

Table 1. Absolute maximum ratings ($T_{amb} = 25\text{ }^{\circ}\text{C}$)

| Symbol | Parameter | Value | Unit | |
|-----------|--|---|--------------------|----|
| V_{PP} | Peak pulse voltage | IEC 61000-4-2 (C = 150 pF, R = 330 Ω) | kV | |
| | | Contact discharge | | 30 |
| | | Air discharge | | 30 |
| P_{PP} | Peak pulse power dissipation | 10/1000 μs , T_j initial = T_{amb} | W | |
| T_{stg} | Storage temperature range | -65 to +175 | $^{\circ}\text{C}$ | |
| T_j | Operating junction temperature range | -55 to +175 | $^{\circ}\text{C}$ | |
| T_L | Maximum lead temperature for soldering during 10 s | 260 | $^{\circ}\text{C}$ | |

Figure 1. Electrical characteristics - parameter definitions

- V_{RM} Maximum stand-off voltage
- I_{RM} Maximum leakage current @ V_{RM}
- V_R Stand-off voltage
- I_R Leakage current @ V_R
- V_{BR} Breakdown voltage @ I_{BR}
- I_{BR} Breakdown current
- V_{CL} Clamping voltage @ I_{PP}
- I_{PP} Peak pulse current
- R_D Dynamic resistance
- V_F Forward voltage drop @ I_F
- I_F Forward current
- αT Voltage temperature coefficient

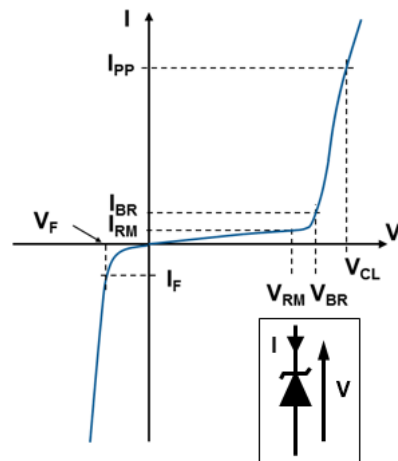

Figure 2. Pulse definition for electrical characteristics

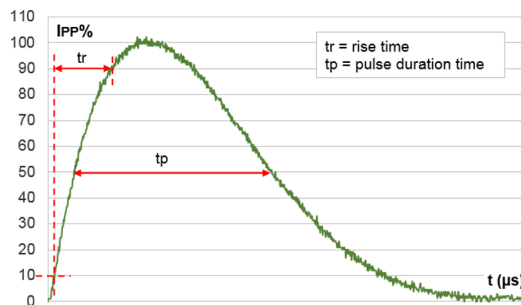

Table 2. Electrical characteristics - parameter values (T_{amb} = 25 °C, unless otherwise specified)

| Type | I _{RM} max at V _{RM} | | | V _{BR} at I _{BR} ⁽¹⁾ | | | | 10 / 1000 μs | | | 8 / 20μs | | | αT |
|------------|--|-------|-----|---|------|------|----|-----------------------------------|--------------------------------|----------------|-----------------------------------|--------------------------------|----------------|----------------------|
| | | | | | | | | V _{CL} ⁽²⁾⁽³⁾ | I _{PP} ⁽⁴⁾ | R _D | V _{CL} ⁽²⁾⁽³⁾ | I _{PP} ⁽⁴⁾ | R _D | |
| | 25 °C | 85 °C | | Min. | Typ. | Max. | | Max. | | Max. | Max. | | Max. | |
| | μA | | V | V | | | mA | V | A | Ω | V | A | Ω | 10 ⁻⁴ /°C |
| SMB15F5.0A | 20 | 50 | 5.0 | 6.4 | 6.74 | 7.1 | 10 | 9.2 | 171 | 0.012 | 13.4 | 746 | 0.008 | 5.7 |
| SMB15F6.0A | 20 | 50 | 6.0 | 6.7 | 7.05 | 7.4 | 10 | 10.3 | 152 | 0.019 | 13.7 | 730 | 0.009 | 5.9 |
| SMB15F6.5A | 20 | 50 | 6.5 | 7.2 | 7.58 | 8 | 10 | 11.2 | 140 | 0.023 | 14.5 | 690 | 0.009 | 6.1 |
| SMB15F8.5A | 20 | 50 | 8.5 | 9.4 | 9.9 | 10.4 | 1 | 14.4 | 105 | 0.038 | 19.5 | 512 | 0.018 | 7.3 |
| SMB15F10A | 0.2 | 1 | 10 | 11.1 | 11.7 | 12.3 | 1 | 17 | 92 | 0.051 | 21.7 | 461 | 0.020 | 7.8 |
| SMB15F11A | 0.2 | 1 | 11 | 12.3 | 13 | 13.7 | 1 | 18 | 85 | 0.051 | 24.2 | 413 | 0.025 | 8.1 |
| SMB15F12A | 0.2 | 1 | 12 | 13.3 | 14 | 14.7 | 1 | 19.9 | 79 | 0.066 | 25.3 | 394 | 0.027 | 8.3 |
| SMB15F13A | 0.2 | 1 | 13 | 14.4 | 15.2 | 16 | 1 | 21.5 | 73 | 0.075 | 27.2 | 368 | 0.030 | 8.4 |
| SMB15F14A | 0.2 | 1 | 14 | 15.7 | 16.5 | 17.3 | 1 | 23.1 | 67 | 0.087 | 29 | 338 | 0.035 | 8.6 |
| SMB15F15A | 0.2 | 1 | 15 | 16.7 | 17.6 | 18.5 | 1 | 24.4 | 64 | 0.092 | 32.5 | 308 | 0.045 | 8.8 |
| SMB15F16A | 0.2 | 1 | 16 | 17.9 | 18.8 | 19.8 | 1 | 26 | 58 | 0.107 | 34.7 | 293 | 0.049 | 9.0 |
| SMB15F18A | 0.2 | 1 | 18 | 20 | 21.1 | 22.2 | 1 | 29.2 | 53 | 0.132 | 39.3 | 254 | 0.067 | 9.2 |
| SMB15F20A | 0.2 | 1 | 20 | 22.2 | 23.4 | 24.6 | 1 | 32.4 | 48 | 0.163 | 42.8 | 234 | 0.078 | 9.4 |
| SMB15F22A | 0.2 | 1 | 22 | 24.4 | 25.7 | 27 | 1 | 35.5 | 44 | 0.193 | 48.3 | 207 | 0.103 | 9.6 |
| SMB15F23A | 0.2 | 1 | 23 | 25.7 | 27 | 28.4 | 1 | 37.8 | 41 | 0.229 | 49.2 | 202 | 0.103 | 9.6 |
| SMB15F24A | 0.2 | 1 | 24 | 26.7 | 28.1 | 29.5 | 1 | 38.9 | 40 | 0.235 | 50 | 200 | 0.103 | 9.6 |
| SMB15F26A | 0.2 | 1 | 26 | 28.9 | 30.4 | 31.9 | 1 | 42.1 | 37 | 0.276 | 53.5 | 187 | 0.116 | 9.7 |
| SMB15F28A | 0.2 | 1 | 28 | 31.1 | 32.7 | 34.3 | 1 | 45.4 | 34 | 0.326 | 59 | 169 | 0.146 | 9.8 |
| SMB15F30A | 0.2 | 1 | 30 | 33.2 | 35 | 36.8 | 1 | 48.4 | 32 | 0.363 | 64.3 | 156 | 0.176 | 9.9 |
| SMB15F31A | 0.2 | 1 | 31 | 34.2 | 36 | 37.8 | 1 | 50.2 | 31 | 0.400 | 65 | 153 | 0.178 | 9.9 |
| SMB15F33A | 0.2 | 1 | 33 | 36.7 | 38.6 | 40.5 | 1 | 53.3 | 29 | 0.441 | 69.7 | 143 | 0.204 | 10 |
| SMB15F36A | 0.2 | 1 | 36 | 40 | 42.1 | 44.2 | 1 | 58.1 | 26 | 0.539 | 76 | 131 | 0.243 | 10 |
| SMB15F40A | 0.2 | 1 | 40 | 44.4 | 46.7 | 49 | 1 | 64.5 | 24 | 0.646 | 84 | 119 | 0.294 | 10.1 |
| SMB15F48A | 0.2 | 1 | 48 | 53.2 | 56 | 58.8 | 1 | 77.4 | 20 | 0.930 | 100 | 100 | 0.412 | 10.3 |
| SMB15F58A | 0.2 | 1 | 58 | 64.6 | 68 | 71.4 | 1 | 93.6 | 16 | 1.39 | 121 | 83 | 0.598 | 10.4 |
| SMB15F64A | 0.2 | 1 | 64 | 71.1 | 74.8 | 78.6 | 1 | 103 | 14.6 | 1.66 | 134 | 75 | 0.74 | 10.5 |

1. To calculate V_{BR} versus T_j: V_{BR} at T_j = V_{BR} at 25 °C x (1 + αT x (T_j - 25))
2. To calculate V_{CL} versus T_j: V_{CL} at T_j = V_{CL} at 25 °C x (1 + αT x (T_j - 25))
3. To calculate V_{CL} max versus I_{PPappli}: V_{CLmax} = V_{BR} max + R_D x I_{PPappli}
4. Surge capability given for both directions

1.1 Characteristics (curves)

Figure 3. Maximum peak power dissipation versus initial junction temperature

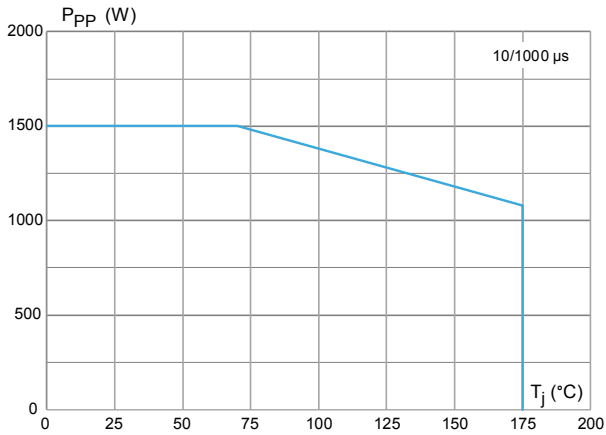

Figure 4. Maximum peak pulse power versus exponential pulse duration

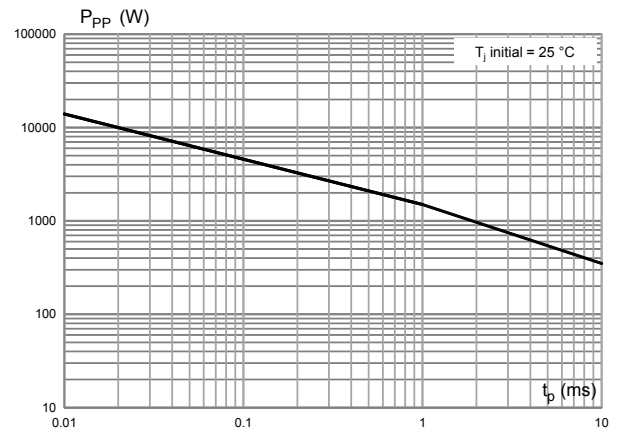

Figure 5. Maximum peak pulse current versus clamping voltage

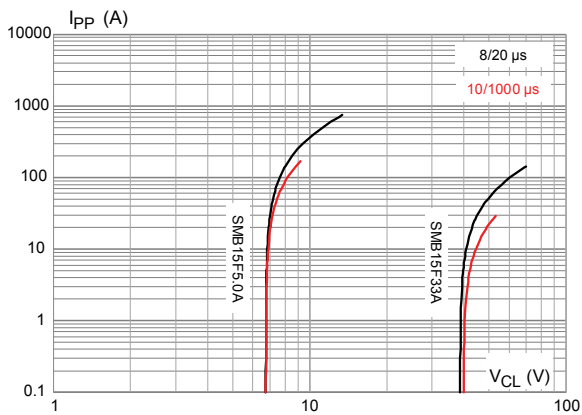

Figure 6. Dynamic resistance versus pulse duration

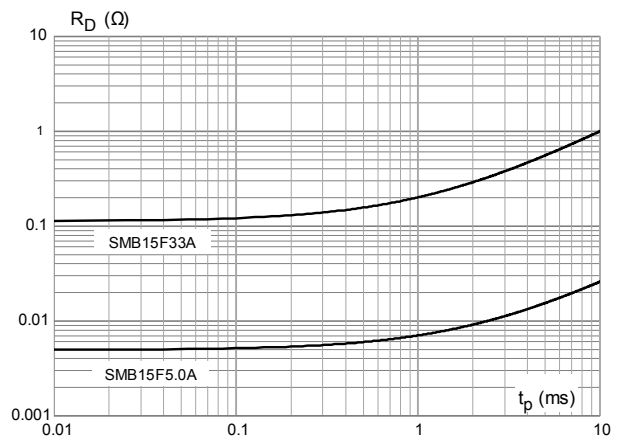

Figure 7. Junction capacitance versus reverse applied voltage (unidirectional types)

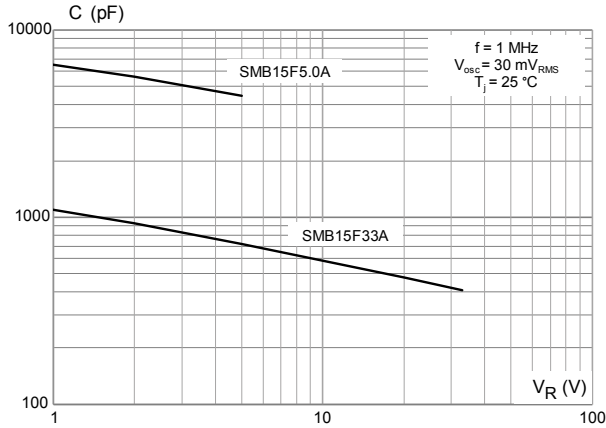

Figure 8. Leakage current versus junction temperature

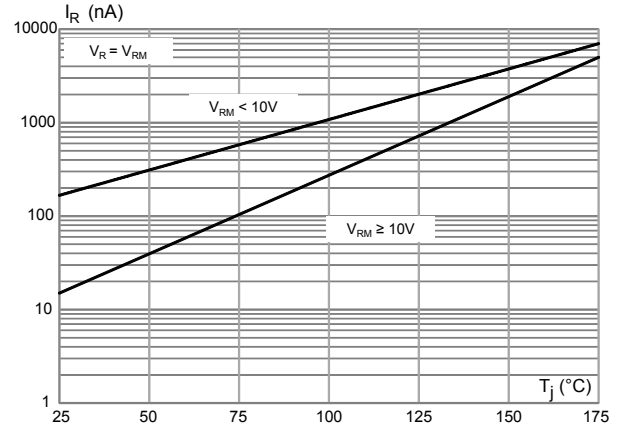

Figure 9. Peak forward voltage drop versus peak forward current

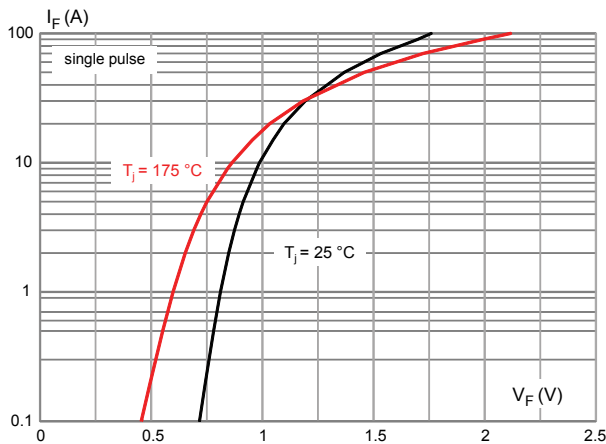

Figure 10. Thermal impedance junction to ambient versus pulse duration

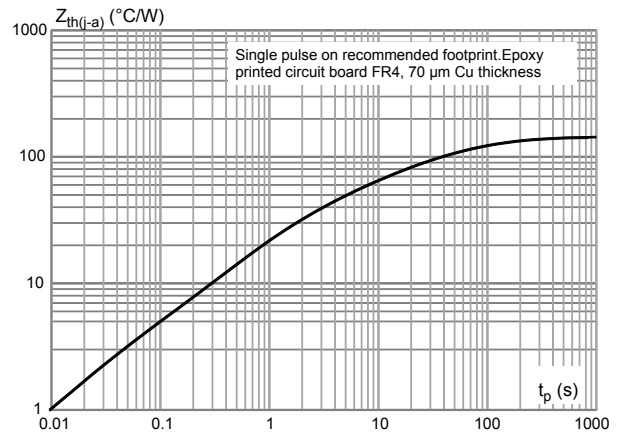
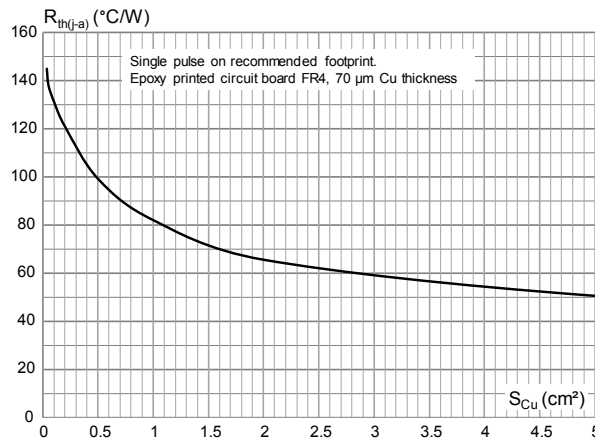

Figure 11. Thermal resistance junction to ambient versus copper area under each lead (SMB Flat)



2 Package information

In order to meet environmental requirements, ST offers these devices in different grades of **ECOPACK** packages, depending on their level of environmental compliance. ECOPACK specifications, grade definitions and product status are available at: www.st.com. ECOPACK is an ST trademark.

2.1 SMB Flat package information

Figure 12. SMB Flat package outline

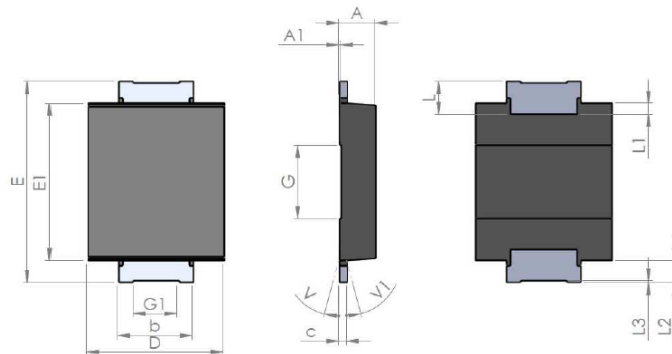

Table 3. SMB Flat mechanical data

| Ref. | Dimensions | | | | | |
|------|-------------|------|------|-----------------------|-------|-------|
| | Millimeters | | | Inches ⁽¹⁾ | | |
| | Min. | Typ. | Max. | Min. | Typ. | Max. |
| A | 0.90 | | 1.10 | 0.035 | | 0.044 |
| A1 | | 0.05 | | | 0.002 | |
| b | 1.95 | | 2.20 | 0.076 | | 0.087 |
| c | 0.15 | | 0.40 | 0.005 | | 0.016 |
| D | 3.30 | | 3.95 | 0.129 | | 0.156 |
| E | 5.20 | | 5.60 | 0.204 | | 0.221 |
| E1 | 4.05 | | 4.60 | 0.159 | | 0.182 |
| G | | 2.00 | | | 0.079 | |
| G1 | | 1.20 | | | 0.047 | |
| L | 0.75 | | 1.20 | 0.029 | | 0.048 |
| L1 | | 0.30 | | | 0.012 | |
| L2 | | 0.60 | | | 0.024 | |
| L3 | 0.02 | | | 0.000 | | |
| V | | | 8° | | | 8° |
| V1 | | | 8° | | | 8° |

1. Values in inches are converted from mm and rounded to 3 decimal digits.

Figure 13. Footprint recommendations, dimensions in mm (inches)

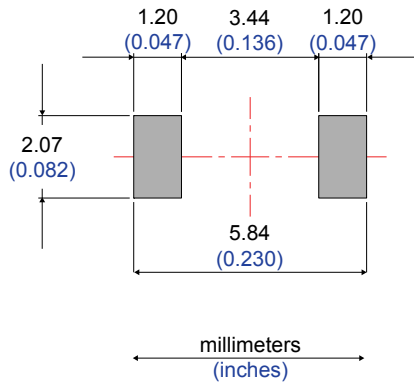

Figure 14. Marking layout (refer to ordering information table for marking)

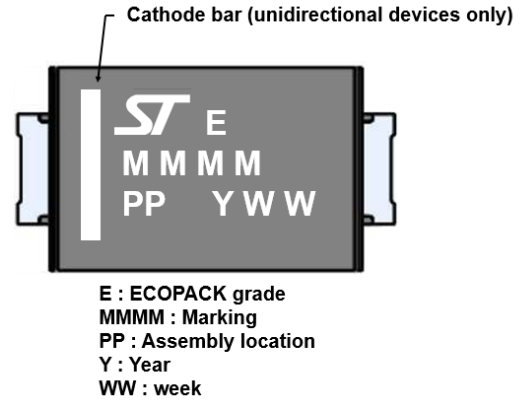
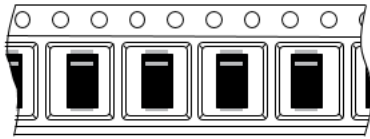

Figure 15. Package orientation in reel



Taped according to EIA-481
Note: Pocket dimensions are not on scale
Pocket shape may vary depending on package
On bidirectional devices, marking and logo may be not always in the same direction

Figure 16. Tape and reel orientation

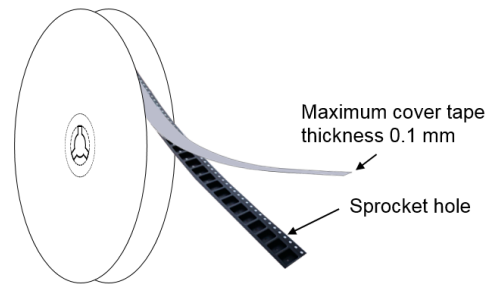

Figure 17. Reel dimensions (mm)

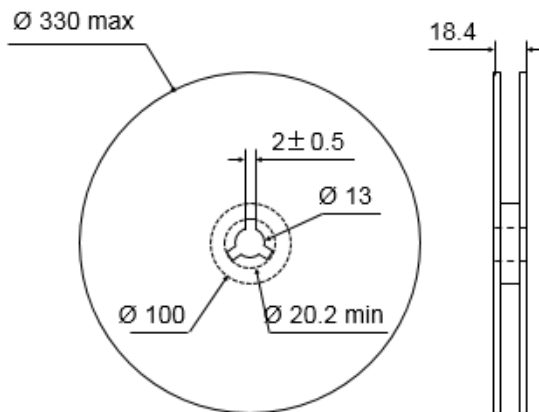

Figure 18. Inner box dimensions (mm)

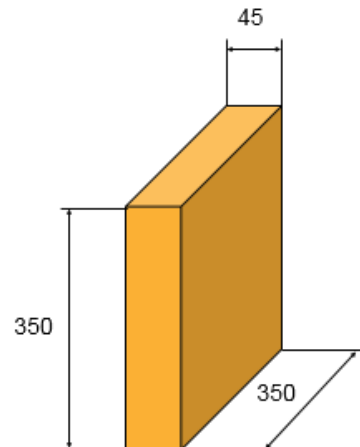
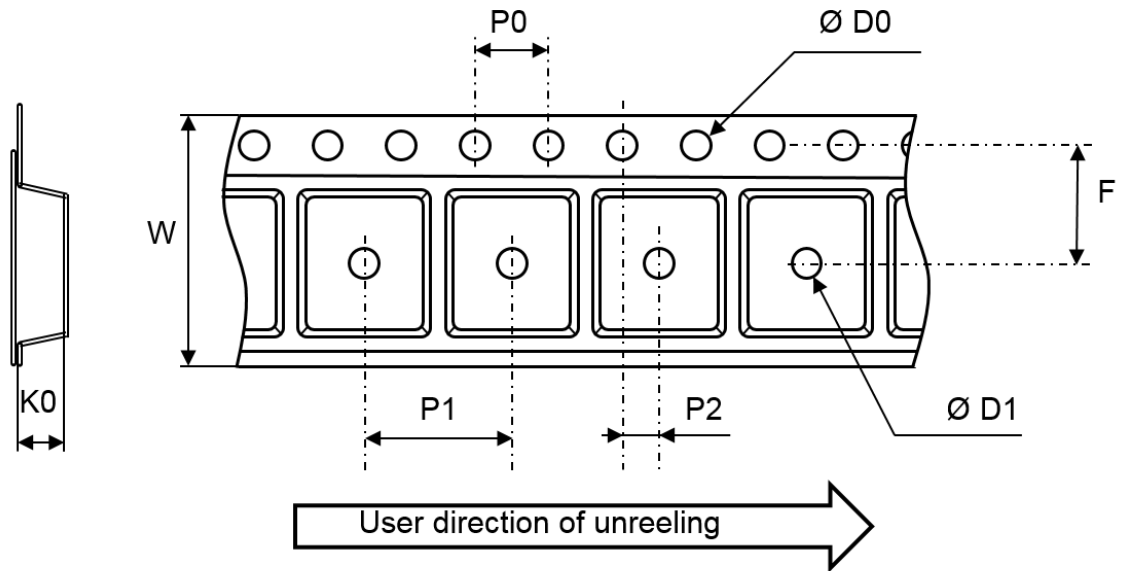

Figure 19. Tape and reel outline



Note: Pocket dimensions are not on scale
Pocket shape may vary depending on package

Table 4. Tape and reel mechanical data

| Ref. | Dimensions | | |
|------|-------------|------|------|
| | Millimeters | | |
| | Min. | Typ. | Max. |
| ØD0 | 1.45 | 1.50 | 1.55 |
| ØD1 | 1.5 | | |
| F | 5.4 | 5.5 | 5.6 |
| K0 | 1.2 | 1.3 | 1.4 |
| P0 | 3.9 | 4.0 | 4.1 |
| P1 | 7.9 | 8.0 | 8.1 |
| P2 | 1.9 | 2.0 | 2.1 |
| W | 11.7 | 12.0 | 12.3 |

2.2 Reflow profile

Figure 20. ST ECOPACK recommended soldering reflow profile for PCB mounting

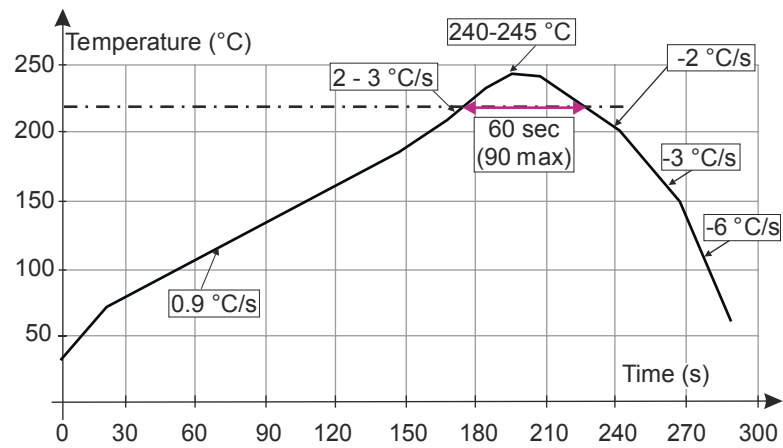

Note: Minimize air convection currents in the reflow oven to avoid component movement. Maximum soldering profile corresponds to the latest IPC/JEDEC J-STD-020.

3 Ordering information

Figure 21. Ordering information scheme

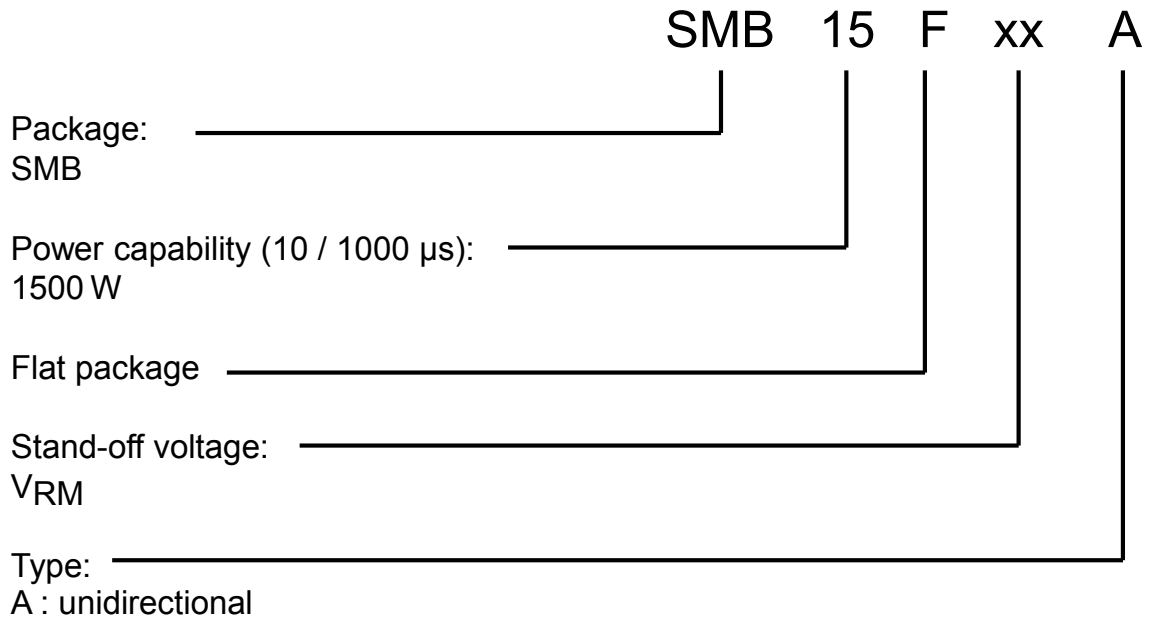

Table 5. Ordering information

| Order code | Marking | Package | Weight | Base qty. | Delivery mode |
|------------|-----------------------|----------|--------|-----------|---------------|
| SMB15FxxA | See Table 6. Marking. | SMB Flat | 60 mg | 5000 | Tape and reel |

Table 6. Marking

| Order code | Marking |
|------------|---------|
| SMB15F5.0A | FAI |
| SMB15F6.0A | FAK |
| SMB15F6.5A | FAL |
| SMB15F8.5A | FAP |
| SMB15F10A | FAS |
| SMB15F11A | FAU |
| SMB15F12A | FAW |
| SMB15F13A | FAY |
| SMB15F14A | FBA |
| SMB15F15A | FBC |
| SMB15F16A | FBE |
| SMB15F18A | FBI |
| SMB15F20A | FBM |
| SMB15F22A | FBO |
| SMB15F23A | FBP |
| SMB15F24A | FBQ |
| SMB15F26A | FBS |
| SMB15F28A | FBU |
| SMB15F30A | FBW |
| SMB15F31A | FBX |
| SMB15F33A | FBZ |
| SMB15F36A | FCC |
| SMB15F40A | FCG |
| SMB15F48A | FCO |
| SMB15F58A | FCY |
| SMB15F64A | FDE |

Revision history

Table 7. Document revision history

| Date | Revision | Changes |
|-------------|----------|------------------|
| 31-Aug-2020 | 1 | Initial release. |

IMPORTANT NOTICE – PLEASE READ CAREFULLY

STMicroelectronics NV and its subsidiaries (“ST”) reserve the right to make changes, corrections, enhancements, modifications, and improvements to ST products and/or to this document at any time without notice. Purchasers should obtain the latest relevant information on ST products before placing orders. ST products are sold pursuant to ST’s terms and conditions of sale in place at the time of order acknowledgement.

Purchasers are solely responsible for the choice, selection, and use of ST products and ST assumes no liability for application assistance or the design of Purchasers’ products.

No license, express or implied, to any intellectual property right is granted by ST herein.

Resale of ST products with provisions different from the information set forth herein shall void any warranty granted by ST for such product.

ST and the ST logo are trademarks of ST. For additional information about ST trademarks, please refer to www.st.com/trademarks. All other product or service names are the property of their respective owners.

Information in this document supersedes and replaces information previously supplied in any prior versions of this document.

© 2020 STMicroelectronics – All rights reserved