

ON Semiconductor

Is Now

onsemi™

To learn more about onsemi™, please visit our website at
www.onsemi.com

onsemi and **onsemi** and other names, marks, and brands are registered and/or common law trademarks of Semiconductor Components Industries, LLC dba "**onsemi**" or its affiliates and/or subsidiaries in the United States and/or other countries. **onsemi** owns the rights to a number of patents, trademarks, copyrights, trade secrets, and other intellectual property. A listing of **onsemi** product/patent coverage may be accessed at www.onsemi.com/site/pdf/Patent-Marking.pdf. **onsemi** reserves the right to make changes at any time to any products or information herein, without notice. The information herein is provided "as-is" and **onsemi** makes no warranty, representation or guarantee regarding the accuracy of the information, product features, availability, functionality, or suitability of its products for any particular purpose, nor does **onsemi** assume any liability arising out of the application or use of any product or circuit, and specifically disclaims any and all liability, including without limitation special, consequential or incidental damages. Buyer is responsible for its products and applications using **onsemi** products, including compliance with all laws, regulations and safety requirements or standards, regardless of any support or applications information provided by **onsemi**. "Typical" parameters which may be provided in **onsemi** data sheets and/or specifications can and do vary in different applications and actual performance may vary over time. All operating parameters, including "Typicals" must be validated for each customer application by customer's technical experts. **onsemi** does not convey any license under any of its intellectual property rights nor the rights of others. **onsemi** products are not designed, intended, or authorized for use as a critical component in life support systems or any FDA Class 3 medical devices or medical devices with a same or similar classification in a foreign jurisdiction or any devices intended for implantation in the human body. Should Buyer purchase or use **onsemi** products for any such unintended or unauthorized application, Buyer shall indemnify and hold **onsemi** and its officers, employees, subsidiaries, affiliates, and distributors harmless against all claims, costs, damages, and expenses, and reasonable attorney fees arising out of, directly or indirectly, any claim of personal injury or death associated with such unintended or unauthorized use, even if such claim alleges that **onsemi** was negligent regarding the design or manufacture of the part. **onsemi** is an Equal Opportunity/Affirmative Action Employer. This literature is subject to all applicable copyright laws and is not for resale in any manner. Other names and brands may be claimed as the property of others.

TinyLogic ULP-A Inverter

NC7SV04

The NC7SV04 is a single Inverter in tiny footprint packages. The device is designed to operate for $V_{CC} = 0.9\text{ V}$ to 3.6 V .

Features

- Designed for 0.9 V to 3.6 V V_{CC} Operation
- 1.5 ns t_{PD} at 3.3 V (Typ)
- Inputs/Outputs Over-Voltage Tolerant up to 3.6 V
- I_{OFF} Supports Partial Power Down Protection
- Source/Sink 24 mA at 3.3 V
- Available in SC-88A and MicroPak™ Packages
- These Devices are Pb-Free, Halogen Free/BFR Free and are RoHS Compliant

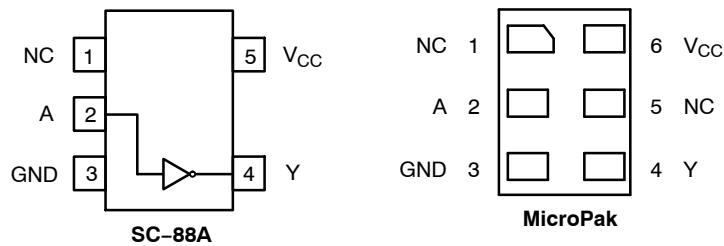

Figure 1. Pinout Diagrams (Top Views)

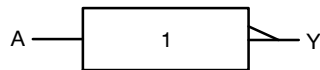

Figure 2. Logic Symbol

PIN ASSIGNMENT

| Pin | SC-88A | MicroPak |
|-----|----------|----------|
| 1 | N.C. | N.C. |
| 2 | A | A |
| 3 | GND | GND |
| 4 | Y | Y |
| 5 | V_{CC} | N.C. |
| 6 | - | V_{CC} |

N.C. = No Connect

FUNCTION TABLE

| Input | Output |
|-------|--------|
| A | Y |
| L | H |
| H | L |



ON Semiconductor®

www.onsemi.com

MARKING DIAGRAMS



SIP6 1.45X1.0
MicroPak
CASE 127EB

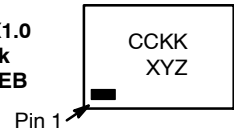

UDFN6
MicroPak2
CASE 517DP

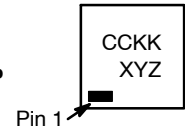

CC = Specific Device Code
KK = 2-Digit Lot Run Traceability Code
XY = 2-Digit Date Code
Z = Assembly Plant Code



SC-88A
CASE 419A-02

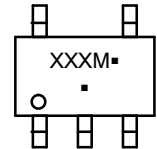

XXX = Specific Device Code
M = Date Code
▪ = Pb-Free Package

ORDERING INFORMATION

See detailed ordering, marking and shipping information on page 6 of this data sheet.

NC7SV04

MAXIMUM RATINGS

| Symbol | Characteristics | Value | Unit |
|-------------------------------------|--|---|------|
| V _{CC} | DC Supply Voltage | -0.5 to +4.3 | V |
| V _{IN} | DC Input Voltage | -0.5 to +4.3 | V |
| V _{OUT} | DC Output Voltage Active-Mode (High or Low State) Tri-State Mode (Note 1) Power-Down Mode (V _{CC} = 0 V) | -0.5 to V _{CC} + 0.5 -0.5 to +4.3 -0.5 to +4.3 | V |
| I _{IK} | DC Input Diode Current V _{IN} < GND | -50 | mA |
| I _{OK} | DC Output Diode Current V _{OUT} < GND | -50 | mA |
| I _{OUT} | DC Output Source/Sink Current | ±50 | mA |
| I _{CC} or I _{GND} | DC Supply Current per Supply Pin or Ground Pin | ±50 | mA |
| T _{STG} | Storage Temperature Range | -65 to +150 | °C |
| T _L | Lead Temperature, 1 mm from Case for 10 Seconds | 260 | °C |
| T _J | Junction Temperature Under Bias | +150 | °C |
| θ _{JA} | Thermal Resistance (Note 2) SC-88A MicroPak | 377 154 | °C/W |
| P _D | Power Dissipation in Still Air SC-88A MicroPak | 332 812 | mW |
| MSL | Moisture Sensitivity | Level 1 | - |
| F _R | Flammability Rating Oxygen Index: 28 to 34 | UL 94 V-0 @ 0.125 in | - |
| V _{ESD} | ESD Withstand Voltage (Note 3) Human Body Model Charged Device Model | 4000 2000 | V |
| I _{Latchup} | Latchup Performance (Note 4) | ±100 | mA |

Stresses exceeding those listed in the Maximum Ratings table may damage the device. If any of these limits are exceeded, device functionality should not be assumed, damage may occur and reliability may be affected.

1. Applicable to devices with outputs that may be tri-stated.
2. Measured with minimum pad spacing on an FR4 board, using 10 mm-by-1 inch, 2 ounce copper trace no air flow per JESD51-7.
3. HBM tested to EIA / JESD22-A114-A. CDM tested to JESD22-C101-A. JEDEC recommends that ESD qualification to EIA/JESD22-A115A (Machine Model) be discontinued.
4. Tested to EIA/JESD78 Class II.

NC7SV04

RECOMMENDED OPERATING CONDITIONS

| Symbol | Parameter | Min | Max | Unit |
|------------|-------------------------------------|---|------------------------|------|
| V_{CC} | Positive DC Supply Voltage | 0.9 | 3.6 | V |
| V_{IN} | DC Input Voltage | 0 | 3.6 | V |
| V_{OUT} | DC Output Voltage | Active-Mode (High or Low State) Tri-State Mode (Note 1) Power-Down Mode ($V_{CC} = 0$ V) | V_{CC} 3.6 3.6 | |
| T_A | Operating Temperature Range | -40 | +85 | °C |
| t_r, t_f | Input Transition Rise and Fall Time | $V_{CC} = 3.3$ V \pm 0.3 V | | ns/V |

Functional operation above the stresses listed in the Recommended Operating Ranges is not implied. Extended exposure to stresses beyond the Recommended Operating Ranges limits may affect device reliability.

DC ELECTRICAL CHARACTERISTICS

| Symbol | Parameter | Condition | V_{CC} (V) | $T_A = 25^\circ\text{C}$ | | | $T_A = -40^\circ\text{C to } +85^\circ\text{C}$ | | Unit | |
|-------------------|---------------------------|-------------------------------|--------------|--------------------------|----------------|----------------------|---|----------------------|------|---|
| | | | | Min | Typ | Max | Min | Max | | |
| V_{IH} | High-Level Input Voltage | | 0.9 | - | 0.5 | - | - | - | V | |
| | | | 1.1 to 1.3 | $0.65 \times V_{CC}$ | - | - | $0.65 \times V_{CC}$ | - | | |
| | | | 1.4 to 1.6 | $0.65 \times V_{CC}$ | - | - | $0.65 \times V_{CC}$ | - | | |
| | | | 1.65 to 1.95 | $0.65 \times V_{CC}$ | - | - | $0.65 \times V_{CC}$ | - | | |
| | | | 2.3 to <2.7 | 1.6 | - | - | 1.6 | - | | |
| | | | 2.7 to 3.6 | 2.0 | - | - | 2.0 | - | | |
| V_{IL} | Low-Level Input Voltage | | 0.9 | - | 0.5 | - | - | - | V | |
| | | | 1.1 to 1.3 | - | - | $0.35 \times V_{CC}$ | - | $0.35 \times V_{CC}$ | | |
| | | | 1.4 to 1.6 | - | - | $0.35 \times V_{CC}$ | - | $0.35 \times V_{CC}$ | | |
| | | | 1.65 to 1.95 | - | - | $0.35 \times V_{CC}$ | - | $0.35 \times V_{CC}$ | | |
| | | | 2.3 to <2.7 | - | - | 0.7 | - | 0.7 | | |
| | | | 2.7 to 3.6 | - | - | 0.8 | - | 0.8 | | |
| V_{OH} | High-Level Output Voltage | $V_{IN} = V_{IH}$ or V_{IL} | | | | | | | V | |
| | | $I_{OH} = -100 \mu\text{A}$ | 0.9 | - | $V_{CC} - 0.1$ | - | - | - | | - |
| | | | 1.1 to 1.3 | $V_{CC} - 0.1$ | - | - | $V_{CC} - 0.1$ | - | | - |
| | | | 1.4 to 1.6 | $V_{CC} - 0.1$ | - | - | $V_{CC} - 0.1$ | - | | - |
| | | | 1.65 to 1.95 | $V_{CC} - 0.2$ | - | - | $V_{CC} - 0.2$ | - | | - |
| | | | 2.3 to <2.7 | $V_{CC} - 0.2$ | - | - | $V_{CC} - 0.2$ | - | | - |
| | | | 2.7 to 3.6 | $V_{CC} - 0.2$ | - | - | $V_{CC} - 0.2$ | - | | - |
| | | $I_{OH} = -2$ mA | 1.1 to 1.3 | $0.75 \times V_{CC}$ | - | - | $0.75 \times V_{CC}$ | - | | - |
| | | | 1.4 to 1.6 | $0.75 \times V_{CC}$ | - | - | $0.75 \times V_{CC}$ | - | | - |
| | | $I_{OH} = -4$ mA | 1.65 to 1.95 | 1.25 | - | - | 1.25 | - | | - |
| | | | 2.3 to <2.7 | 2.0 | - | - | 2.0 | - | | - |
| | | $I_{OH} = -6$ mA | 2.3 to <2.7 | 1.8 | - | - | 1.8 | - | | - |
| | | | 2.7 to 3.6 | 2.2 | - | - | 2.2 | - | | - |
| | | $I_{OH} = -12$ mA | 2.3 to <2.7 | 1.7 | - | - | 1.7 | - | | - |
| | | | 2.7 to 3.6 | 2.4 | - | - | 2.4 | - | | - |
| $I_{OH} = -18$ mA | 2.7 to 3.6 | 2.2 | - | - | 2.2 | - | - | | | |
| | | | | | | | | | | |

NC7SV04

DC ELECTRICAL CHARACTERISTICS (continued)

| Symbol | Parameter | Condition | V _{CC} (V) | T _A = 25°C | | | T _A = -40°C to +85°C | | Unit | |
|-------------------------|---------------------------|---|---------------------|-----------------------|-----|------------------------|---------------------------------|------------------------|------|---|
| | | | | Min | Typ | Max | Min | Max | | |
| V _{OL} | Low-Level Output Voltage | V _{IN} = V _{IH} or V _{IL} | | | | | | | V | |
| | | I _{OL} = 100 μA | 0.9 | - | 0.1 | - | - | - | | - |
| | | | 1.1 to 1.3 | - | - | 0.1 | - | 0.1 | | - |
| | | | 1.4 to 1.6 | - | - | 0.1 | - | 0.1 | | - |
| | | | 1.65 to 1.95 | - | - | 0.2 | - | 0.2 | | - |
| | | | 2.3 to <2.7 | - | - | 0.2 | - | 0.2 | | - |
| | | | 2.7 to 3.6 | - | - | 0.2 | - | 0.2 | | - |
| | | I _{OL} = 2 mA | 1.1 to 1.3 | - | - | 0.25 x V _{CC} | - | 0.25 x V _{CC} | | - |
| | | | 1.4 to 1.6 | - | - | 0.25 x V _{CC} | - | 0.25 x V _{CC} | | - |
| | | I _{OL} = 4 mA | 1.65 to 1.95 | - | - | 0.3 | - | 0.3 | | - |
| | | | 2.3 to <2.7 | - | - | 0.4 | - | 0.4 | | - |
| | | I _{OL} = 6 mA | 2.7 to 3.6 | - | - | 0.4 | - | 0.4 | | - |
| | | | 2.3 to <2.7 | - | - | 0.6 | - | 0.6 | | - |
| I _{OL} = 12 mA | 2.7 to 3.6 | - | - | 0.4 | - | 0.4 | - | | | |
| | 2.3 to <2.7 | - | - | 0.6 | - | 0.6 | - | | | |
| I _{OL} = 18 mA | 2.7 to 3.6 | - | - | 0.4 | - | 0.4 | - | | | |
| | 2.3 to <2.7 | - | - | 0.6 | - | 0.6 | - | | | |
| I _{OL} = 24 mA | 2.7 to 3.6 | - | - | 0.55 | - | 0.55 | - | | | |
| | 2.3 to <2.7 | - | - | 0.6 | - | 0.6 | - | | | |
| I _{IN} | Input Leakage Current | V _{IN} = 0 V to 3.6 V | 0.9 to 3.6 | - | - | ±0.1 | - | ±0.5 | μA | |
| I _{OFF} | Power Off Leakage Current | V _{IN} = 0 V to 3.6 V or V _{OUT} = 0 V to 3.6 V | 0 | - | - | 0.5 | - | 0.5 | μA | |
| I _{CC} | Quiescent Supply Current | V _{IN} = V _{CC} or GND | 0.9 to 3.6 | - | - | 0.9 | - | 0.9 | μA | |

Product parametric performance is indicated in the Electrical Characteristics for the listed test conditions, unless otherwise noted. Product performance may not be indicated by the Electrical Characteristics if operated under different conditions.

AC ELECTRICAL CHARACTERISTICS

| Symbol | Parameter | Condition | V _{CC} (V) | T _A = 25°C | | | T _A = -40°C to +85°C | | Unit |
|--|---|--|---------------------|-----------------------|------|-----|---------------------------------|------|------|
| | | | | Min | Typ | Max | Min | Max | |
| t _{PLH} , t _{PHL} | Propagation Delay, A to Y (Figures 3 and 4) | R _L = 1 MΩ, C _L = 15 pF | 0.9 | - | 11.7 | - | - | - | ns |
| | | R _L = 2 kΩ, C _L = 15 pF | 1.1 to 1.3 | - | 5.5 | 9.0 | - | 13.9 | |
| | | | 1.4 to 1.6 | - | 3.1 | 5.1 | - | 6.0 | |
| | | | 1.65 to 1.95 | - | 2.4 | 4.2 | - | 5.2 | |
| | | R _L = 500 Ω, C _L = 30 pF | 2.3 to 2.7 | - | 1.8 | 2.7 | - | 3.4 | |
| | | | 2.7 to 3.6 | - | 1.5 | 2.3 | - | 2.8 | |

CAPACITIVE CHARACTERISTICS

| Symbol | Parameter | Test Condition | Typical (T _A = 25°C) | Unit |
|-----------------|--|--|---------------------------------|------|
| C _{IN} | Input Capacitance | V _{CC} = 0 V | 2.0 | pF |
| C _{PD} | Power Dissipation Capacitance (Note 5) | f = 10 MHz, V _{CC} = 0.9 to 3.6 V, V _{IN} = 0 V or V _{CC} | 10.0 | pF |

5. C_{PD} is defined as the value of the internal equivalent capacitance which is calculated from the operating current consumption without load. Average operating current can be obtained by the equation I_{CC(OPR)} = C_{PD} • V_{CC} • f_{in} + I_{CC}. C_{PD} is used to determine the no-load dynamic power consumption: P_D = C_{PD} • V_{CC}² • f_{in} + I_{CC} • V_{CC}.

NC7SV04

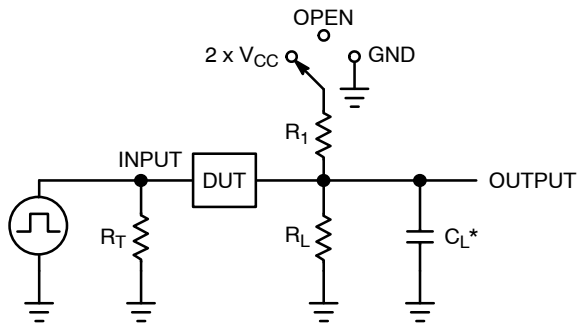

C_L includes probe and jig capacitance
 R_T is Z_{OUT} of pulse generator (typically 50 Ω)
 $f = 1$ MHz

| Test | Switch Position |
|---------------------|-------------------|
| t_{PLH} / t_{PHL} | Open |
| t_{PLZ} / t_{PZL} | $2 \times V_{CC}$ |
| t_{PHZ} / t_{PZH} | GND |

Figure 3. Test Circuit



| V_{CC}, V | V_{mi}, V | V_{mo}, V | V_Y, V |
|--------------|--------------|--------------|----------|
| 0.9 | $V_{CC} / 2$ | $V_{CC} / 2$ | 0.1 |
| 1.1 to 1.3 | $V_{CC} / 2$ | $V_{CC} / 2$ | 0.1 |
| 1.4 to 1.6 | $V_{CC} / 2$ | $V_{CC} / 2$ | 0.1 |
| 1.65 to 1.95 | $V_{CC} / 2$ | $V_{CC} / 2$ | 0.15 |
| 2.3 to 2.7 | $V_{CC} / 2$ | $V_{CC} / 2$ | 0.15 |
| 3.0 to 3.6 | 1.5 | 1.5 | 0.3 |

Figure 4. Switching Waveforms

NC7SV04

ORDERING INFORMATION

| Device | Package | Marking | Pin 1 Orientation (See below) | Shipping† |
|------------|-----------|---------|----------------------------------|--------------------|
| NC7SV04P5X | SC-88A | V04 | Q4 | 3000 / Tape & Reel |
| NC7SV04L6X | MicroPak | F7 | Q4 | 5000 / Tape & Reel |
| NC7SV04FHX | MicroPak2 | F7 | Q4 | 5000 / Tape & Reel |

†For information on tape and reel specifications, including part orientation and tape sizes, please refer to our Tape and Reel Packaging Specifications Brochure, BRD8011/D.

Pin 1 Orientation in Tape and Reel

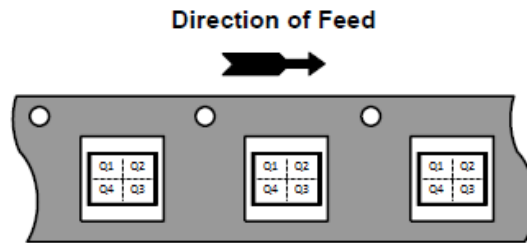

MicroPak is trademark of Semiconductor Components Industries, LLC (SCILLC) or its subsidiaries in the United States and/or other countries.

NC7SV04

PACKAGE DIMENSIONS

SIP6 1.45X1.0
CASE 127EB
ISSUE O

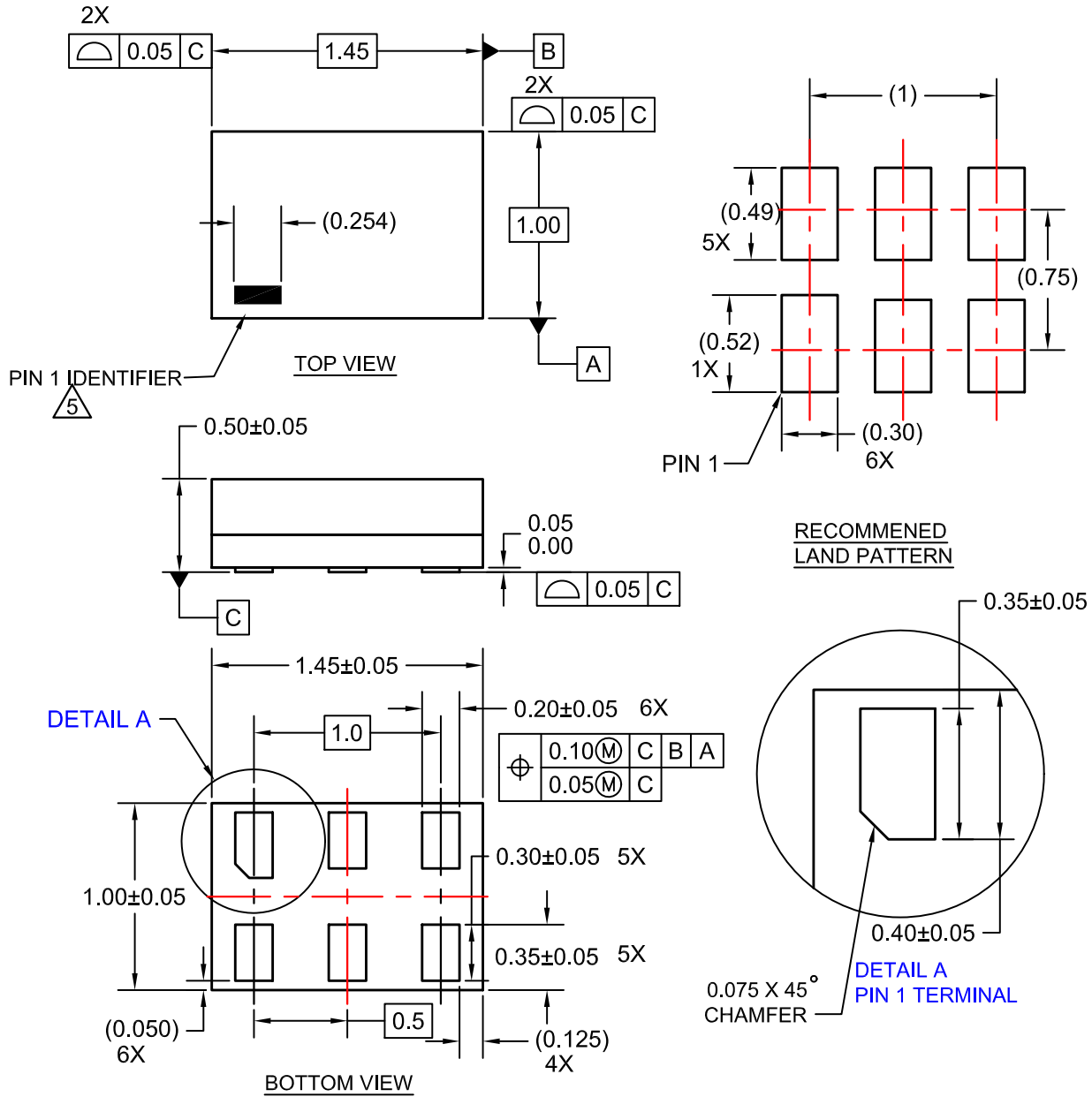

NOTES:

1. CONFORMS TO JEDEC STANDARD MO-252 VARIATION UAAD
2. DIMENSIONS ARE IN MILLIMETERS
3. DRAWING CONFORMS TO ASME Y14.5M-2009
4. PIN ONE IDENTIFIER IS 2X LENGTH OF ANY OTHER LINE IN THE MARK CODE LAYOUT.

NC7SV04

PACKAGE DIMENSIONS

UDFN6 1.0X1.0, 0.35P
CASE 517DP
ISSUE O

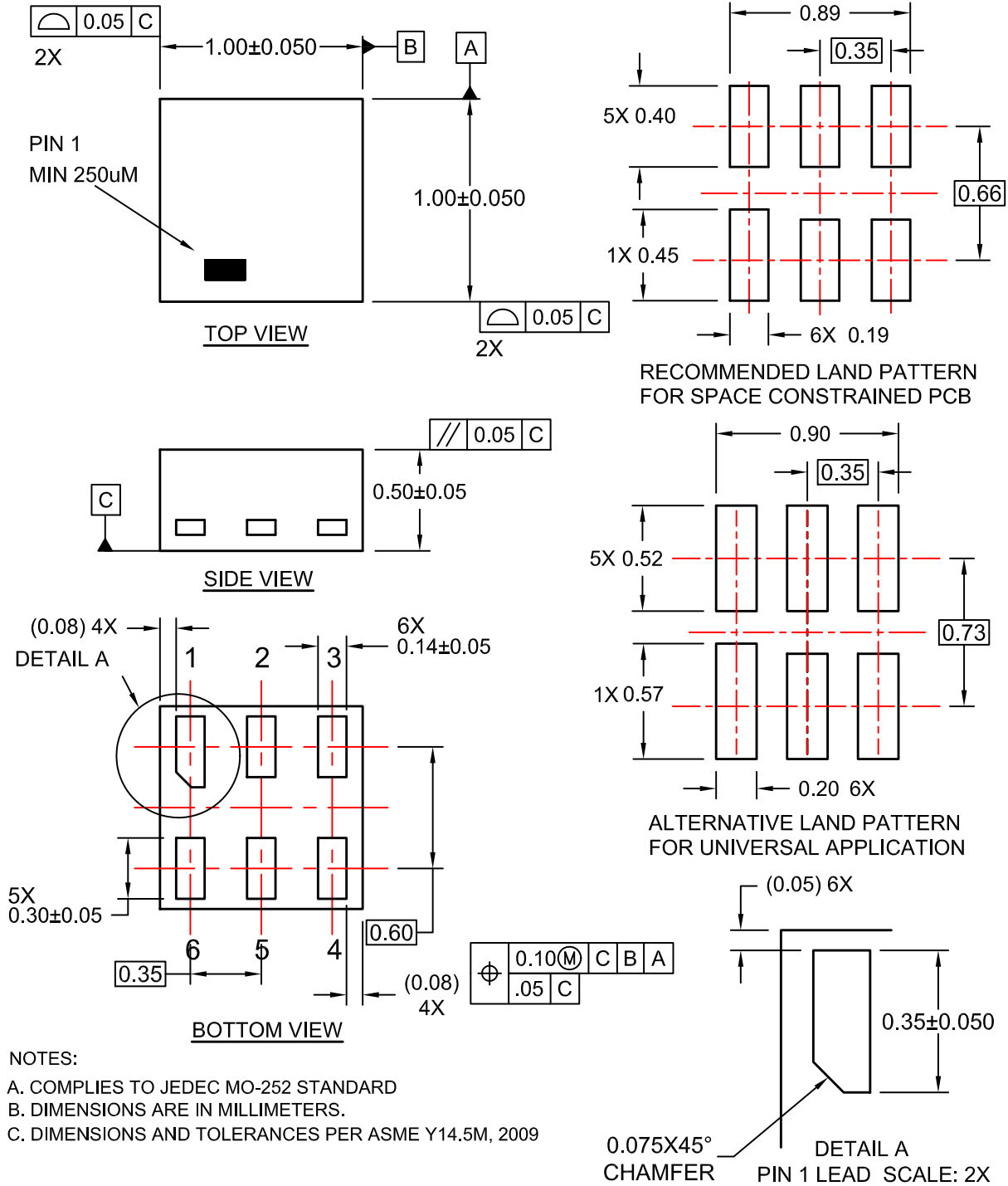

NC7SV04

PACKAGE DIMENSIONS

SC-88A (SC-70-5/SOT-353)
CASE 419A-02
ISSUE L

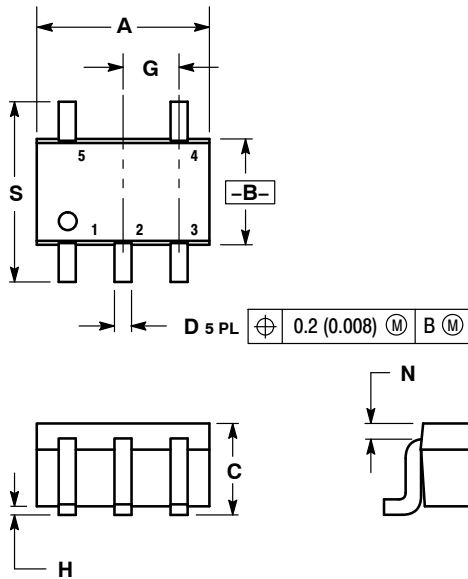

NOTES:

1. DIMENSIONING AND TOLERANCING PER ANSI Y14.5M, 1982.
2. CONTROLLING DIMENSION: INCH.
3. 419A-01 OBSOLETE. NEW STANDARD 419A-02.
4. DIMENSIONS A AND B DO NOT INCLUDE MOLD FLASH, PROTRUSIONS, OR GATE BURRS.

| DIM | INCHES | | MILLIMETERS | |
|-----|-----------|-------|-------------|------|
| | MIN | MAX | MIN | MAX |
| A | 0.071 | 0.087 | 1.80 | 2.20 |
| B | 0.045 | 0.053 | 1.15 | 1.35 |
| C | 0.031 | 0.043 | 0.80 | 1.10 |
| D | 0.004 | 0.012 | 0.10 | 0.30 |
| G | 0.026 BSC | | 0.65 BSC | |
| H | --- | 0.004 | --- | 0.10 |
| J | 0.004 | 0.010 | 0.10 | 0.25 |
| K | 0.004 | 0.012 | 0.10 | 0.30 |
| N | 0.008 REF | | 0.20 REF | |
| S | 0.079 | 0.087 | 2.00 | 2.20 |

SOLDER FOOTPRINT

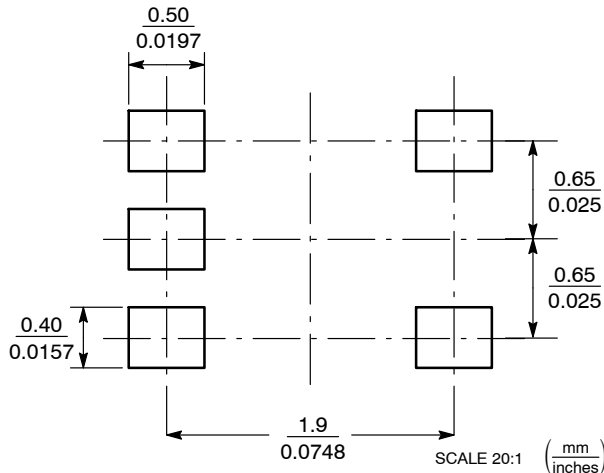

ON Semiconductor and are trademarks of Semiconductor Components Industries, LLC dba ON Semiconductor or its subsidiaries in the United States and/or other countries. ON Semiconductor owns the rights to a number of patents, trademarks, copyrights, trade secrets, and other intellectual property. A listing of ON Semiconductor's product/patent coverage may be accessed at www.onsemi.com/site/pdf/Patent-Marking.pdf. ON Semiconductor reserves the right to make changes without further notice to any products herein. ON Semiconductor makes no warranty, representation or guarantee regarding the suitability of its products for any particular purpose, nor does ON Semiconductor assume any liability arising out of the application or use of any product or circuit, and specifically disclaims any and all liability, including without limitation special, consequential or incidental damages. Buyer is responsible for its products and applications using ON Semiconductor products, including compliance with all laws, regulations and safety requirements or standards, regardless of any support or applications information provided by ON Semiconductor. "Typical" parameters which may be provided in ON Semiconductor data sheets and/or specifications can and do vary in different applications and actual performance may vary over time. All operating parameters, including "Typicals" must be validated for each customer application by customer's technical experts. ON Semiconductor does not convey any license under its patent rights nor the rights of others. ON Semiconductor products are not designed, intended, or authorized for use as a critical component in life support systems or any FDA Class 3 medical devices or medical devices with a same or similar classification in a foreign jurisdiction or any devices intended for implantation in the human body. Should Buyer purchase or use ON Semiconductor products for any such unintended or unauthorized application, Buyer shall indemnify and hold ON Semiconductor and its officers, employees, subsidiaries, affiliates, and distributors harmless against all claims, costs, damages, and expenses, and reasonable attorney fees arising out of, directly or indirectly, any claim of personal injury or death associated with such unintended or unauthorized use, even if such claim alleges that ON Semiconductor was negligent regarding the design or manufacture of the part. ON Semiconductor is an Equal Opportunity/Affirmative Action Employer. This literature is subject to all applicable copyright laws and is not for resale in any manner.

PUBLICATION ORDERING INFORMATION

LITERATURE FULFILLMENT:
Email Requests to: orderlit@onsemi.com

TECHNICAL SUPPORT
North American Technical Support:
Voice Mail: 1 800-282-9855 Toll Free USA/Canada
Phone: 011 421 33 790 2910

Europe, Middle East and Africa Technical Support:
Phone: 00421 33 790 2910
For additional information, please contact your local Sales Representative