



LIS3L02AQ3

MEMS INERTIAL SENSOR: 3-Axis - $\pm 2g/\pm 6g$ LINEAR ACCELEROMETER

1 Features

- 2.4V TO 3.6V SINGLE SUPPLY OPERATION
- LOW POWER CONSUMPTION
- $\pm 2g/\pm 6g$ USER SELECTABLE FULL-SCALE
- BETTER THAN 0.5mg RESOLUTION OVER 100Hz BANDWIDTH
- EMBEDDED SELF TEST AND POWER DOWN
- OUTPUT VOLTAGE, OFFSET AND SENSITIVITY RATIO METRIC TO THE SUPPLY VOLTAGE
- HIGH SHOCK SURVIVABILITY
- ECO-PACK COMPLIANT

2 Description

The LIS3L02AQ3 is a low-power 3-Axis linear capacitive accelerometer that includes a sensing element and an IC interface able to take the information from the sensing element and to provide an analog signal to the external world.

The sensing element, capable of detecting the acceleration, is manufactured using a dedicated process developed by ST to produce inertial sensors and actuators in silicon.

The IC interface is manufactured using a standard CMOS process that allows high level of integration to design a dedicated circuit which is trimmed to better match the sensing element characteristics.

The LIS3L02AQ3 has a user selectable full scale of

Figure 1. Package

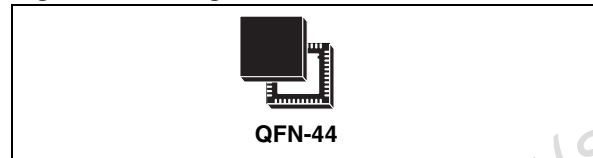

Table 1. Order Codes

Part Number	Package	Finishing
LIS3L02AQ3	QFN-44	TRAY
LIS3L02AQ3TR	QFN-44	TAPE & REEL

$\pm 2g, \pm 6g$ and it is capable of measuring accelerations over a bandwidth of 1.5 KHz for all axes. The device bandwidth may be reduced by using external capacitances. A self-test capability allows to check the mechanical and electrical signal path of the sensor.

The LIS3L02AQ3 is available in plastic SMD package and it is specified over an extended temperature range of -40°C to $+85^{\circ}\text{C}$.

The LIS3L02AQ3 belongs to a family of products suitable for a variety of applications:

- Mobile terminals
- Gaming and Virtual Reality input devices
- Free-fall detection for data protection
- Antitheft systems and Inertial Navigation
- Appliance and Robotics

Figure 2. Block Diagram

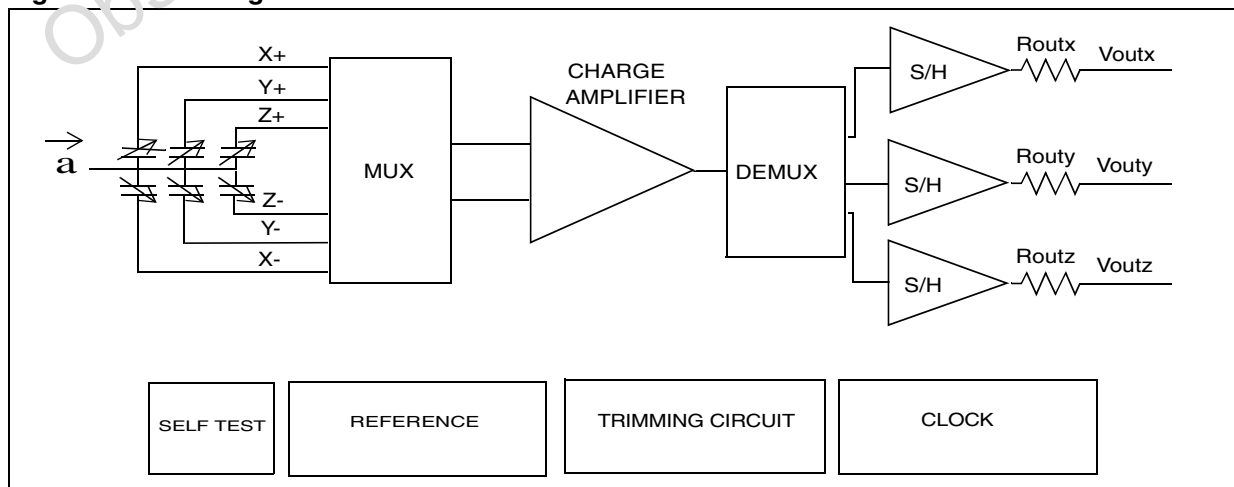

LIS3L02AQ3

Table 2. Pin Description

N°	Pin	Function
1 to 3	NC	Internally not connected
4	GND	0V supply
5	Vdd	Power supply
6	Vouty	Output Voltage, y-channel
7	ST	Self Test (Logic 0: normal mode; Logic 1: Self-test)
8	Voutx	Output Voltage, x-channel
9-13	NC	Internally not connected
14	PD	Power Down (Logic 0: normal mode; Logic 1: Power-Down mode)
15	Voutz	Output Voltage, z-channel
16	FS	Full Scale selection (Logic 0: $\pm 2g$ Full-scale; Logic 1: $\pm 6g$ Full-scale)
17-18	Reserved	Leave unconnected
19	Reserved	Leave unconnected
20	Reserved	Leave unconnected
21	NC	Internally not connected
22-23	Reserved	Leave unconnected
24-25	NC	Internally not connected
26	Reserved	Connect to Vdd or GND
27	Reserved	Leave unconnected or connect to Vdd
28	Reserved	Leave unconnected or connect to GND
29-44	NC	Internally not connected

Figure 3. Pin Connection (Top view)

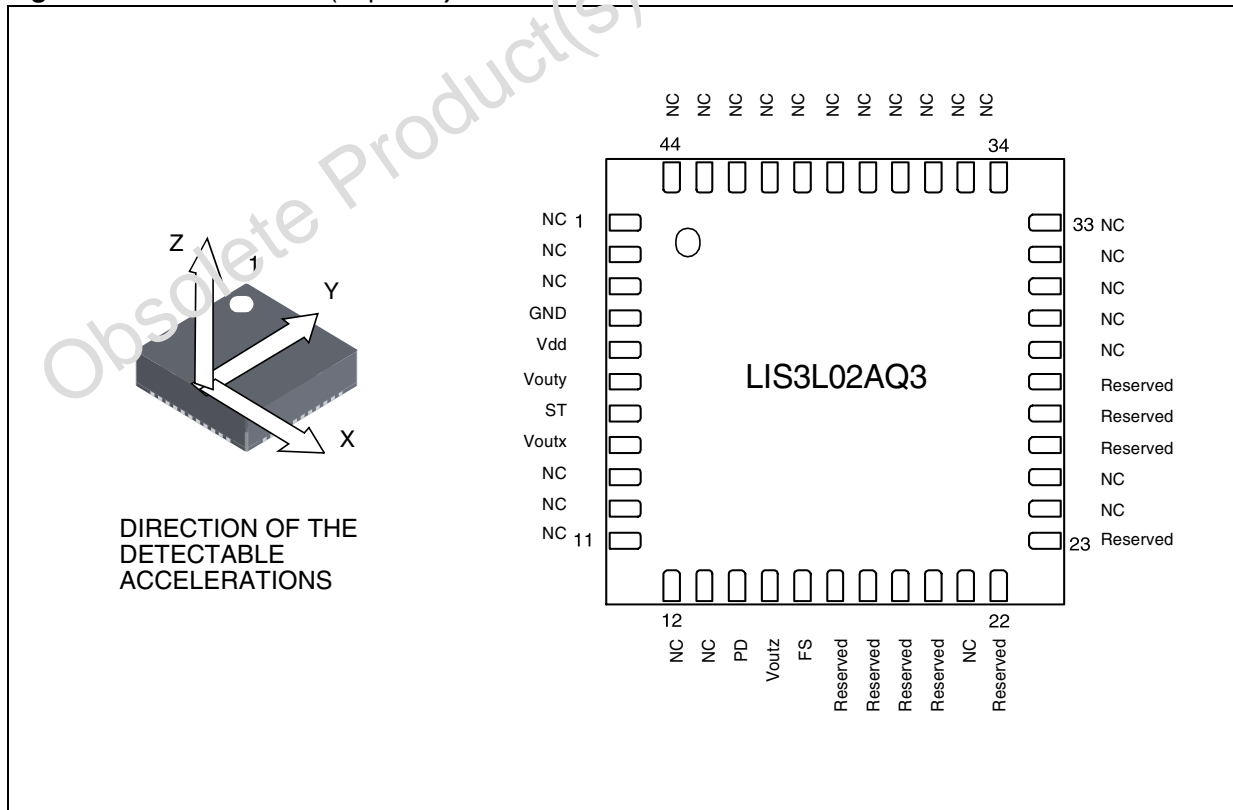

Table 3. Mechanical Characteristics¹

(Temperature range -40°C to +85°C) All the parameters are specified @ Vdd =3.3V, T=25°C unless otherwise noted

Symbol	Parameter	Test Condition	Min.	Typ. ²	Max.	Unit
Ar	Acceleration Range ³	FS pin connected to GND	±1.8	±2.0		g
		FS pin connected to Vdd	±5.4	±6.0		g
So	Sensitivity ⁴	Full-scale = 2g	Vdd/5-10%	Vdd/5	Vdd/5+10%	V/g
		Full-scale = 6g	Vdd/15-10%	Vdd/15	Vdd/15+10%	V/g
SoDr	Sensitivity Change Vs Temperature	Delta from +25°C		±0.01		%/°C
Voff	Zero-g Level ⁴	T = 25°C	Vdd/2-6%	Vdd/2	Vdd/2+6%	mV
OffDr	Zero-g Level Change Vs Temperature	Delta from +25°C		±0.8		mC/°C
NL	Non Linearity ⁵	Best fit straight line Full-scale = 2g X, Y axis		±0.3	±1.5	% FS
		Best fit straight line; Full-scale = 2g Z axis		±0.6	±2	% FS
CrossAx	Cross-Axis ⁶			±2	±4	%
An	Acceleration Noise Density	Vdd=3.3V; Full-scale = 2g		50		µg/ √Hz
Vt	Self Test Output Voltage Change ^{7,8,9}	T = 25°C Vdd=3.3V Full-scale = 2g X axis	-20	-50	-100	mV
		T = 25°C Vdd=3.3V Full-scale = 2g Y axis	20	50	100	mV
		T = 25°C Vdd=3.3V Full-scale = 2g Z axis	20	50	100	mV
Fres	Sensing Element Resonance Frequency ¹⁰	all axes	1.5			KHz
Top	Operating Temperature Range		-40		+85	°C
Wh	Product Weight			0.2		gram

Notes: 1. The product is factory calibrated at 3.3V. The device can be powered from 2.4V to 3.6V. Voff, So and Vt parameters will vary with supply voltage.

2. Typical specifications are not guaranteed

3. Guaranteed by wafer level test and measurement of initial offset and sensitivity

4. Zero-g level and sensitivity are essentially ratiometric to supply voltage

5. Guaranteed by design

6. Contribution to the measuring output of the inclination/acceleration along any perpendicular axis

7. Self test "output voltage change" is defined as $V_{out}(V_{st=Logic1}) - V_{out}(V_{st=Logic0})$

8. Self test "output voltage change" varies cubically with supply voltage

9. When full-scale is set to ±6g, self-test "output voltage change" is one third of the specified value

10. Minimum resonance frequency Fres=1.5KHz. Sensor bandwidth= $1/(2*\pi*110K\Omega*Cl_{oad})$ with $Cl_{oad}>1nF$.

Table 4. Electrical Characteristics¹

(Temperature range -40°C to +85°C) All the parameters are specified @ Vdd =3.3V, T=25°C unless otherwise noted

Symbol	Parameter	Test Condition	Min.	Typ. ²	Max.	Unit
Vdd	Supply Voltage		2.4	3.3	3.6	V
Idd	Supply Current	mean value PD pin connected to GND		0.85	1.5	mA
IddPdn	Supply Current in Power Down Mode	rms value PD pin connected to Vdd		2	5	µA
Vst	Self Test Input	Logic 0 level	0		0.8	V
		Logic 1 level	2.2		Vdd	V
Rout	Output Impedance		80	110	140	kΩ
Cload	Capacitive Load Drive ³		320			pF
Ton	Turn-On Time at Exit From Power Down Mode	Load in µF		550*Cload +0.3		ms
Top	Operating Temperature Range		-40		+85	°C

Notes: 1. The product is factory calibrated at 3.3V.
 2. Typical specifications are not guaranteed
 3. Minimum resonance frequency Fres=1.5KHz. Sensor bandwidth=1/(2*π*110kΩ*Cload) with Cload>1nF

3 Absolute Maximum Rating

Stresses above those listed as “absolute maximum ratings” may cause permanent damage to the device. This is a stress rating only and functional operation of the device under these conditions is not implied. Exposure to maximum rating conditions for extended periods may affect device reliability.

Table 5. Absolute Maximum Rating

Symbol	Ratings	Maximum Value	Unit
Vdd	Supply voltage	-0.3 to 7	V
Vin	Input Voltage on Any Control pin (FS, PD, ST)	-0.3 to Vdd +0.3	V
A _{POW}	Acceleration (Any axis, Powered, Vdd=3.3V)	3000g for 0.5 ms	
		10000g for 0.1 ms	
A _{UNP}	Acceleration (Any axis, Not powered)	3000g for 0.5 ms	
		10000g for 0.1 ms	
T _{STG}	Storage Temperature Range	-40 to +125	°C
ESD	Electrostatic Discharge Protection	2KV HBM	
		200V MM	
		1500V CDM	



This is a ESD sensitive device, improper handling can cause permanent damages to the part.



This is a mechanical shock sensitive device, improper handling can cause permanent damages to the part.

3.1 Terminology

Sensitivity describes the gain of the sensor and can be determined by applying 1g acceleration to it. As the sensor can measure DC accelerations this can be done easily by pointing the axis of interest towards the center of the earth, note the output value, rotate the sensor by 180 degrees (point to the sky) and note the output value again thus applying $\pm 1g$ acceleration to the sensor. Subtracting the larger output value from the smaller one and dividing the result by 2 will give the actual sensitivity of the sensor. This value changes very little over temperature (see sensitivity change vs. temperature) and also very little over time. The Sensitivity Tolerance describes the range of Sensitivities of a large population of sensors.

Zero-g level describes the actual output signal if there is no acceleration present. A sensor in a steady state on a horizontal surface will measure 0g in X axis and 0g in Y axis whereas the Z axis will measure +1g. The output is ideally for a 3.3V powered sensor $V_{dd}/2 = 1650mV$. A deviation from ideal 0-g level (1650mV in this case) is called Zero-g offset. Offset of precise MEMS sensors is to some extent a result of stress to the sensor and therefore the offset can slightly change after mounting the sensor onto a printed circuit board or exposing it to extensive mechanical stress. Offset changes little over temperature - see "Zero-g level change vs. temperature" - the Zero-g level of an individual sensor is very stable over lifetime. The Zero-g level tolerance describes the range of zero-g levels of a population of sensors.

Self Test allows to test the mechanical and electrical part of the sensor. By applying a digital signal to the ST input pin an internal reference is switched to a certain area of the sensor and creates a defined deflection of the moveable structure. The sensor will generate a defined signal and the interface chip will perform the signal conditioning. If the output signal changes with the specified amplitude then the sensor is working properly and the parameters of the interface chip are within the defined specifications.

Output impedance describes the resistor inside the output stage of each channel. This resistor is part of a filter consisting of an external capacitor of at least 320pF and the internal resistor. Due to the high resistor level only small, inexpensive external capacitors are needed to generate low corner frequencies. When interfacing with an ADC it is important to use high input impedance input circuitries to avoid measurement errors. Note that the minimum load capacitance forms a corner frequency beyond the resonance frequency of the sensor. For a flat frequency response a corner frequency well below the resonance frequency is recommended. In general the smallest possible bandwidth for an particular application should be chosen to get the best results.

4 Functionality

The LIS3L02AQ3 is a high performance, low-power, analog output 3-Axis linear accelerometer packaged in a QFN package. The complete device includes a sensing element and an IC interface able to take the information from the sensing element and to provide an analog signal to the external world.

4.1 Sensing element

A proprietary process is used to create a surface micro-machined accelerometer. The technology allows to carry out suspended silicon structures which are attached to the substrate in a few points called anchors and are free to move in the direction of the sensed acceleration. To be compatible with the traditional packaging techniques a cap is placed on top of the sensing element to avoid blocking the moving parts during the moulding phase of the plastic encapsulation.

When an acceleration is applied to the sensor the proof mass displaces from its nominal position, causing an imbalance in the capacitive half-bridge. This imbalance is measured using charge integration in response to a voltage pulse applied to the sense capacitor.

At steady state the nominal value of the capacitors are few pF and when an acceleration is applied the maximum variation of the capacitive load is up to 100fF.

4.2 IC Interface

In order to increase robustness and immunity against external disturbances the complete signal processing chain uses a fully differential structure. The final stage converts the differential signal into a single-ended one to

LIS3L02AQ3

be compatible with the external world.

The signals of the sensing element are multiplexed and fed into a low-noise capacitive charge amplifier that implements a Correlated Double Sampling system (CDS) at its output to cancel the offset and the $1/f$ noise. The output signal is de-multiplexed and transferred to three different S&Hs, one for each channel and made available to the outside.

The low noise input amplifier operates at 200 kHz while the three S&Hs operate at a sampling frequency of 66 kHz. This allows a large oversampling ratio, which leads to in-band noise reduction and to an accurate output waveform.

All the analog parameters (zero-g level, sensitivity and self-test) are ratiometric to the supply voltage. Increasing or decreasing the supply voltage, the sensitivity and the offset will increase or decrease almost linearly. The self test voltage change varies cubically with the supply voltage

4.3 Factory calibration

The IC interface is factory calibrated for sensitivity (S_o) and Zero-g level (V_{off}).

The trimming values are stored inside the device by a non volatile structure. Any time the device is turned on, the trimming parameters are downloaded into the registers to be employed during the normal operation. This allows the user to employ the device without further calibration.

5 Application Hints

Figure 4. LIS3L02AQ3 Electrical Connection

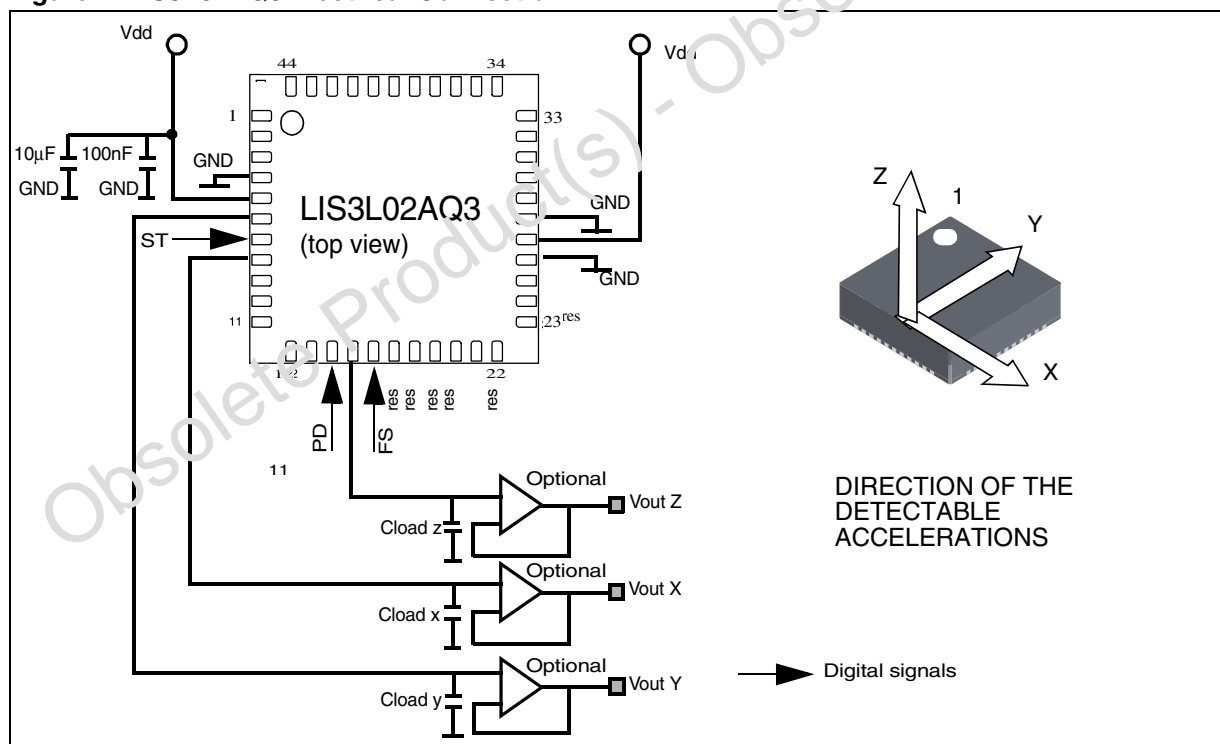

Power supply decoupling capacitors (100nF ceramic or polyester + 10µF Aluminum) should be placed as near as possible to the device (common design practice).

The LIS3L02AQ3 allows to band limit V_{outx} , V_{outy} and V_{outz} through the use of external capacitors. The recommended frequency range spans from DC up to 1.5 KHz. In particular, capacitors must be added at output pins to implement low-pass filtering for antialiasing and noise reduction. The equation for the cut-off frequency

(f_t) of the external filters is:

$$f_t = \frac{1}{2\pi \cdot R_{out} \cdot C_{load}(x, y, z)}$$

Taking in account that the internal filtering resistor (R_{out}) has a nominal value equal to 110k Ω , the equation for the external filter cut-off frequency may be simplified as follows:

$$f_t = \frac{1.45\mu F}{C_{load}(x, y, z)}$$

The tolerance of the internal resistor can vary typically of $\pm 20\%$ within its nominal value of 110k Ω ; thus the cut-off frequency will vary accordingly. A minimum capacitance of 320 pF for $C_f(x,y,z)$ is required in any case.

Table 6. Filter Capacitor Selection, $C_f(x,y,z)$. Commercial capacitance value choose.

Cut-off frequency (Hz)	Capacitor value (nF)
1	1500
10	150
50	30
100	15
200	6.8
500	3

5.1 Soldering information

The QFN44 package is lead free and green package qualified for soldering heat resistance according to JEDEC J-STD-020D. Land pattern and soldering recommendations are available upon request.

6 Typical performance characteristics

6.1 Mechanical Characteristics at 25°C

Figure 5. x-axis 0-g level at 3.3V

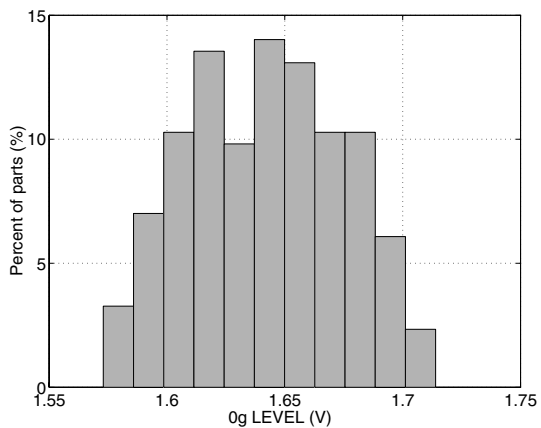

Figure 8. x-axis sensitivity at 3.3V

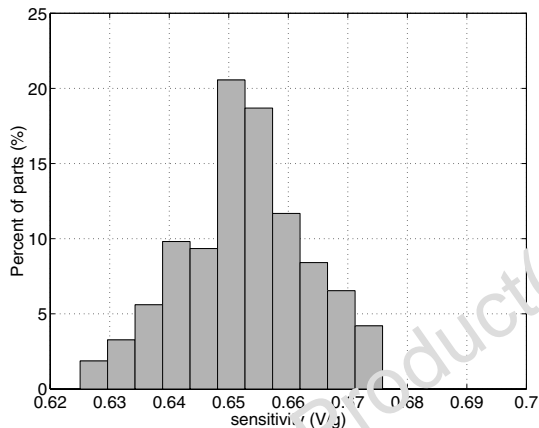

Figure 6. y-axis 0-g level at 3.3V

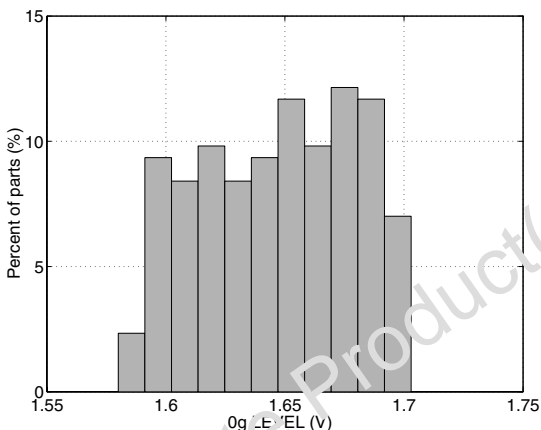

Figure 9. y-axis sensitivity at 3.3V

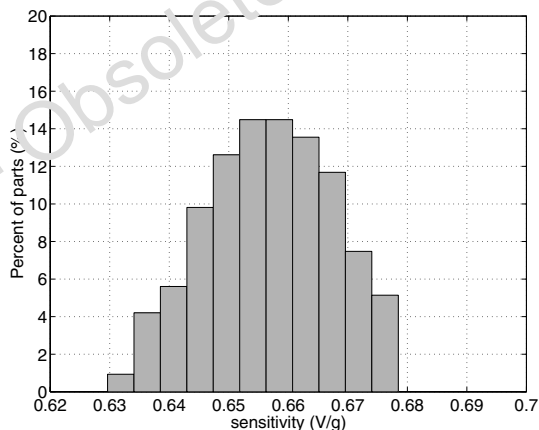

Figure 7. z-axis 0-g level at 3.3V

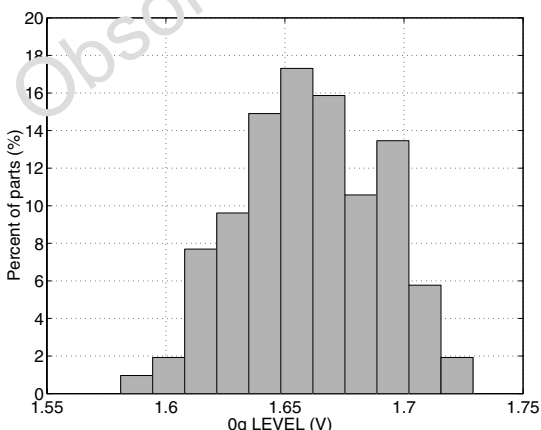
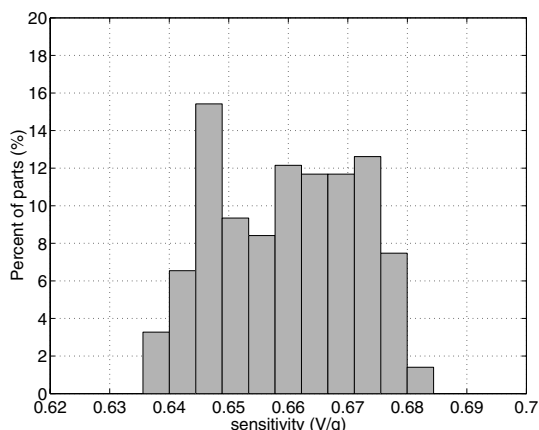

Figure 10. z-axis sensitivity at 3.3V



6.2 Mechanical Characteristics derived from measurement in the -40°C to +85°C temperature range

Figure 11. x-axis 0-g level change vs. temperature

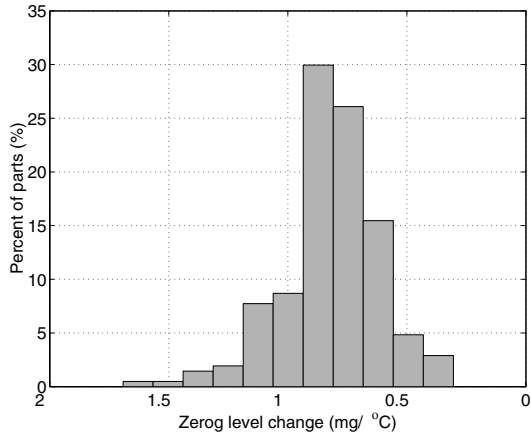

Figure 14. x-axis sensitivity change vs. temperature

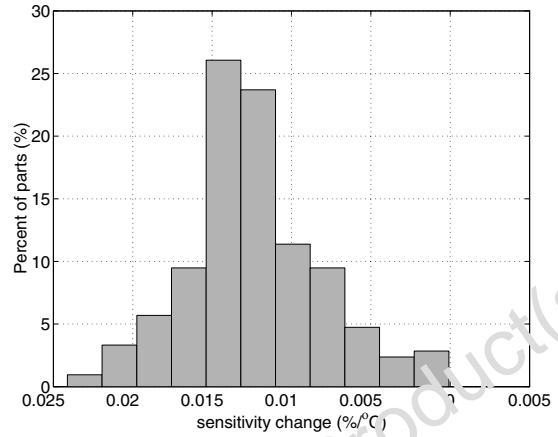

Figure 12. y-axis 0-g level change vs. temperature

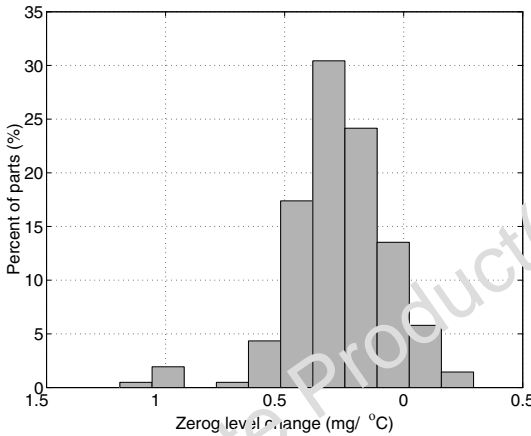

Figure 15. y-axis sensitivity change vs. temperature

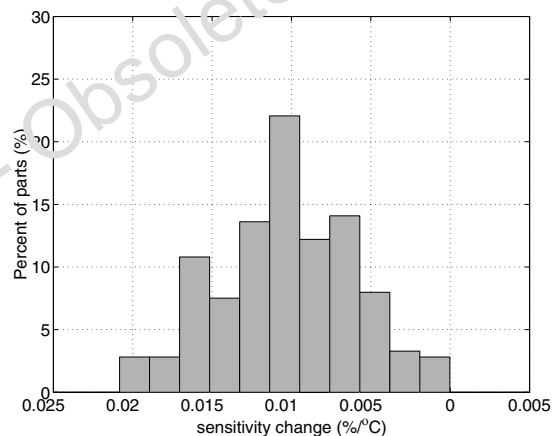

Figure 13. z-axis 0-g level change vs. temperature

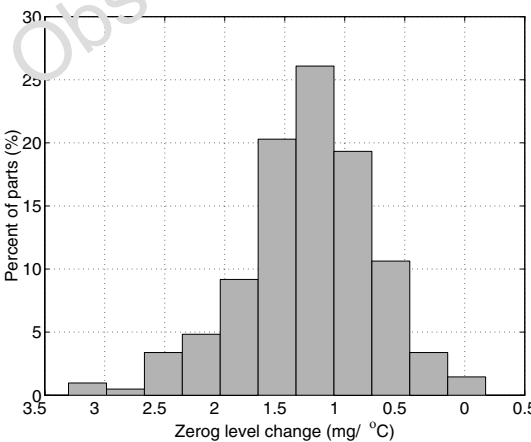
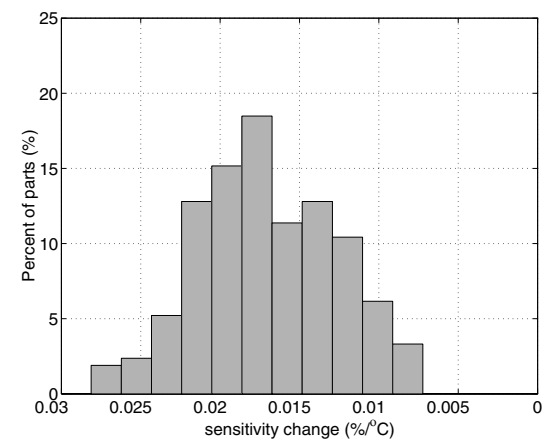

Figure 16. z-axis sensitivity change vs. temperature



6.3 Electrical characteristics at 25°C

Figure 17. Noise density at 3.3V (x,y axes)

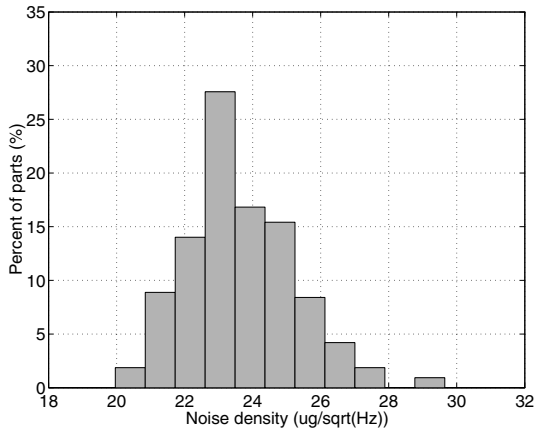

Figure 19. Current consumption at 3.3V

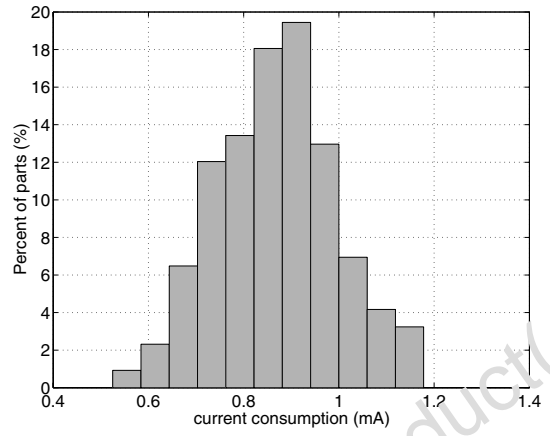

Figure 18. Noise density at 3.3V (z axis)

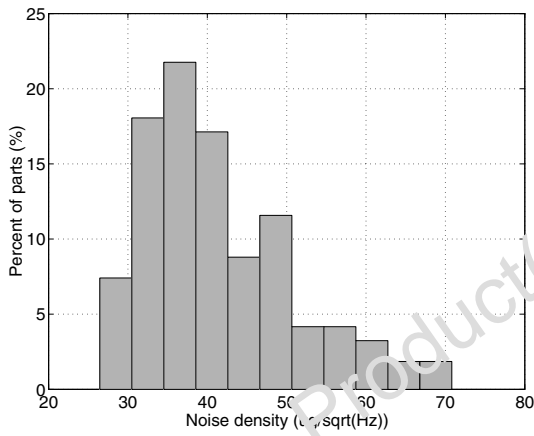
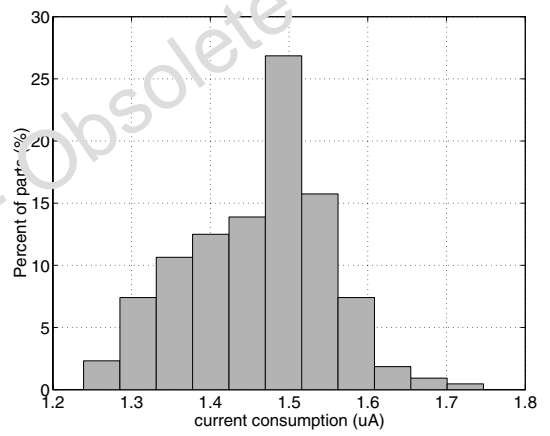
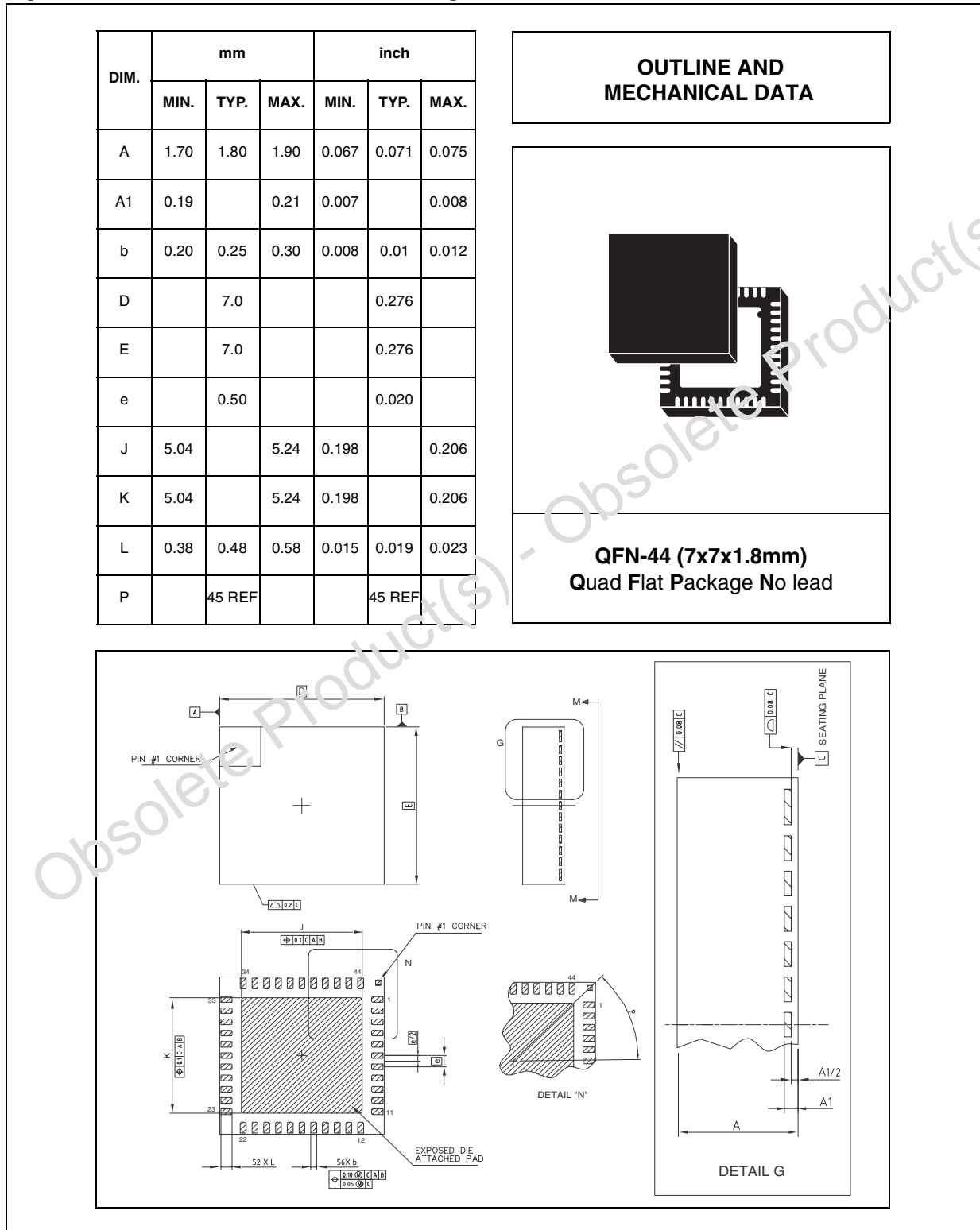

Figure 20. Current consumption in power down mode at 3.3V



7 Package Information

Figure 21. QFN-44 Mechanical Data & Package Dimensions



8 Revision History

Table 7. Revision History

Date	Revision	Description of Changes
November 2004	1	First Issue.
May 2005	2	Major datasheet review.

Obsolete Product(s) - Obsolete Product(s)

Obsolete Product(s) - Obsolete Product(s)

Information furnished is believed to be accurate and reliable. However, STMicroelectronics assumes no responsibility for the consequences of use of such information nor for any infringement of patents or other rights of third parties which may result from its use. No license is granted by implication or otherwise under any patent or patent rights of STMicroelectronics. Specifications mentioned in this publication are subject to change without notice. This publication supersedes and replaces all information previously supplied. STMicroelectronics products are not authorized for use as critical components in life support devices or systems without express written approval of STMicroelectronics.

The ST logo is a registered trademark of STMicroelectronics.
All other names are the property of their respective owners

© 2005 STMicroelectronics - All rights reserved

STMicroelectronics group of companies

Australia - Belgium - Brazil - Canada - China - Czech Republic - Finland - France - Germany - Hong Kong - India - Israel - Italy - Japan - Malaysia - Malta - Morocco - Singapore - Spain - Sweden - Switzerland - United Kingdom - United States of America

www.st.com

