

# NCP1605LCDTVGEVB

## NCP1605/1396 LCD TV Evaluation Board User's Manual



ON Semiconductor®

<http://onsemi.com>

### EVAL BOARD USER'S MANUAL

#### Introduction

This document provides a detailed description of the implementation of an LCD TV power supply. The LDC TV supply unit exhibits high efficiency, low EMI noise and a low profile construction. The board contains DCM/CCM PFC front stage, 210 W LLC power stage and 12.5 W standby flyback converter.

The design requirements for our LCD TV power unit are as follows:

Requirement	Min	Max	Unit
Input Voltage	90	265	Vac
Output Voltage 1	–	12	Vdc
Output Current 1	0	3	A
Output Voltage 2	–	24	Vdc
Output Current 2	0	6	A
Output Voltage 3	–	30	Vdc
Output Current 3	0	1	A
Output Voltage Standby Output	–	5	Vdc
Output Current Standby Output	0	2.5	A
Total Output Power	0	222.5	W
Total No Load Consumption for 0.5 W Load on the Standby Output	–	1	W

NOTE: Only 24 V output is regulated in this version of the board. Additional output(s) regulation can be assured by adding feedback resistors to desired output (or outputs for percentage weight).

The NCP1396A resonant mode controller has been selected for this application because the soft-start absence on the fast fault input offers an easy implementation of the skip cycle mode. This helps to assure regulation of the resonant converter under no load conditions. The NCP1396A offers many other features that are advantageous for our application.

#### Brown-Out (BO) Protection Input

The input voltage of the resonant converter, when divided down, is permanently monitored by the Brownout pin. If the voltage on the bulk capacitor falls outside of the desired operating range, the controller drive output will be shut off. This feature is necessary for an LLC topology that uses PFC stage without PFC OK control output. In our case the BO input is used as an enabling input and is fully controlled by the front stage controller output (PFC OK).

#### Timer Based Fault Protection

The converter stops operation after a programmed delay when the protection is activated. This protection can be implemented as a cumulative or integrating characteristic. Thus, under transient load conditions the converter output will not be turned off, unless the extreme load condition exceeds the timeout.

#### Common Collector Optocoupler Connection

The open collector output allows multiple inputs on the feedback pin i.e. over current sensing circuit, over temperature sensor, etc. The additional input can pull up the feedback voltage level and take over the voltage feedback loop.

#### 600 V High Voltage Floating Driver

The high side driver features a traditional bootstrap circuitry, requiring an external high-voltage diode for the capacitor refueling path. The device incorporates an upper UVLO circuitry that guarantees enough  $V_{GS}$  is available for the upper side MOSFET.

#### Adjustable Dead-Time (DT)

Due to a single resistor wired between DT pin and ground, the user has the option to include needed dead-time, helping to fight cross-conduction between the upper and the lower transistor.

#### Adjustable Minimum and Maximum Frequency Excursion

Using a single external resistor, the designer can program its lowest frequency point, obtained in lack of feedback voltage (during the startup sequence or in short-circuit conditions). Internally trimmed capacitors offer a  $\pm 3\%$  precision on the selection of the minimum switching frequency. The adjustable maximum frequency is less precise ( $\pm 15\%$ ). Please refer to the NCP1396A/B data sheet for detailed description of all mentioned and additional features.

#### Detailed Evaluation Board Connection Description

A schematic of the proposed LCD TV power supply is shown in Figure 1. As already mentioned, the supply contains three blocks: a PFC front stage, an LLC converter and an auxiliary flyback converter that powers a TV set during standby and provides bias power for PFC and LLC control circuits during normal operation.

# NCP1605LCDTVGEVB

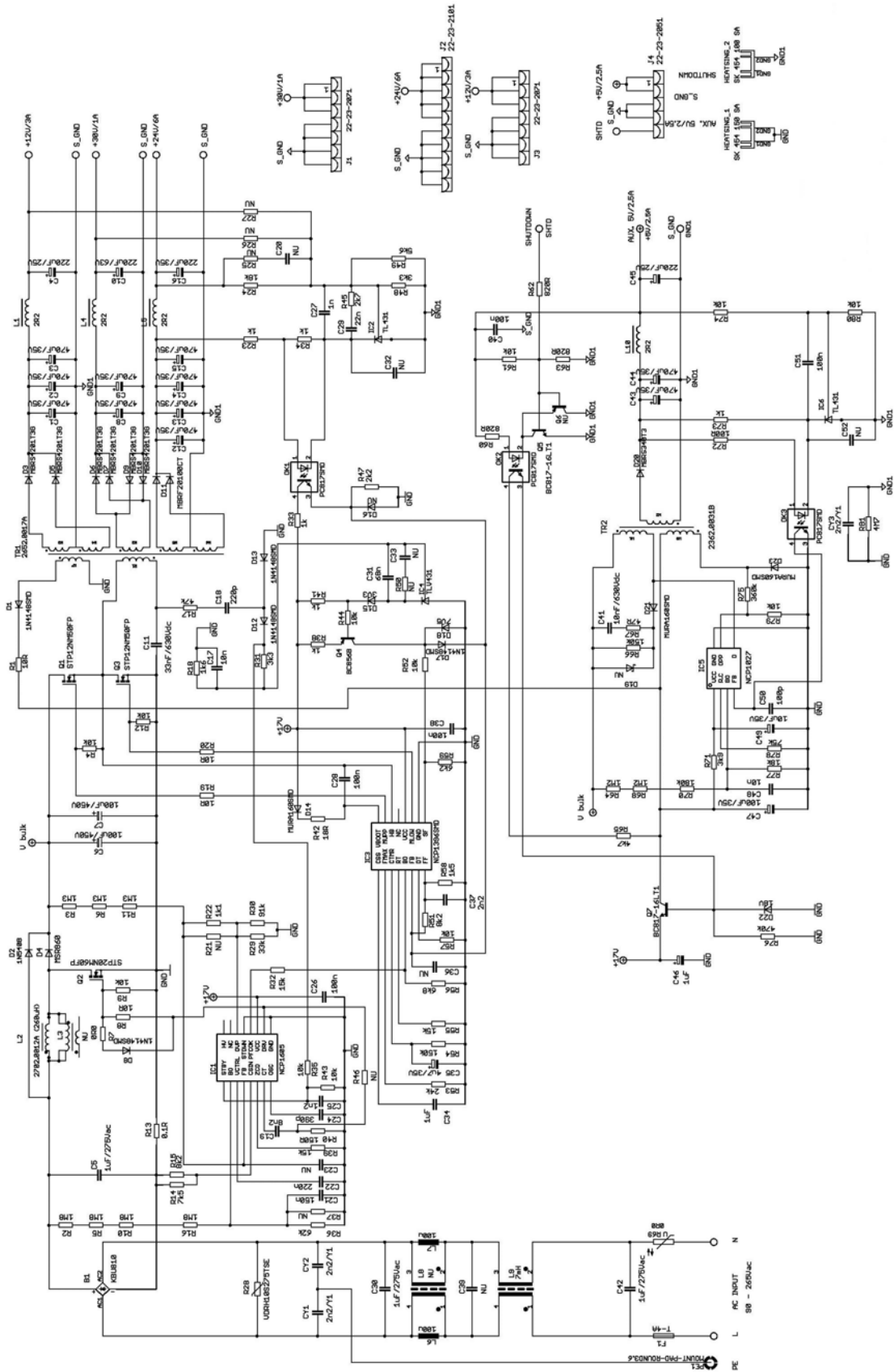


Figure 1. Schematic of the NCP1396A LCD TV Application

## PFC Front Stage

The NCP1605 (IC<sub>1</sub>) PFC controller is used for PFC front stage control. This front stage works either in fixed frequency discontinues mode or critical conduction mode depends on the line and load conditions. Capacitors C<sub>42</sub>, C<sub>30</sub>, CY<sub>1</sub>, CY<sub>2</sub> with common mode choke L<sub>9</sub>, inductors L<sub>6</sub>, L<sub>7</sub> and varistor R<sub>28</sub> form the EMI filter, which suppresses noise conducted to the mains. A bridge rectifier B<sub>1</sub> is used to rectify the input AC line voltage. Capacitor C<sub>5</sub> filters the high frequency ripple current, which is generated by the PFC operation. In this application a classical PFC boost topology is used. The PFC power stage is formed by inductor L<sub>2</sub>, MOSFET switch Q<sub>2</sub>, diode D<sub>4</sub>, bulk capacitors C<sub>6</sub>, C<sub>7</sub> and inrush current bypassing diode D<sub>2</sub>. The current in the PFC stage is monitored by current sense network R<sub>13</sub>, R<sub>14</sub> and R<sub>15</sub>. Right input voltage operating range is adjusted by the Brown Out sensing network R<sub>2</sub>, R<sub>5</sub>, R<sub>10</sub>, R<sub>16</sub>, R<sub>36</sub> and C<sub>21</sub>. Output voltage of the PFC stage is regulated to a nominal 395 Vdc via the feedback network R<sub>3</sub>, R<sub>6</sub>, R<sub>11</sub>, R<sub>22</sub>, R<sub>29</sub> and R<sub>30</sub>. Sensing network described above is also used to monitor an overvoltage condition on the PFC output using the NCP1605 OVP pin. PFC regulation loop bandwidth is limited by the capacitor C<sub>22</sub>. The sensitivity of the zero current detection circuitry is given by the resistor R<sub>39</sub> value. Capacitor C<sub>19</sub> and resistor R<sub>40</sub> are used to control the maximum Q<sub>2</sub> switch on-time. Capacitor C<sub>24</sub> dictates the DCM operating frequency. Skip mode of the PFC front stage is initiated by the NCP1605 controller when the voltage on the STBY pin is lower than 0.3 V. Since the LLC stage voltage feedback and also bulk capacitor voltage have opposing reaction function (increasing when output load decreases), the divided (R<sub>35</sub>, R<sub>43</sub> and C<sub>25</sub>) LLC stage primary current information has been used to trigger the PFC skip mode during light load conditions.

The controller receives the V<sub>CC</sub> voltage from standby stage when standard operation mode is enabled by the TV set application.

Please refer to the application note AND8281/D for a detailed explanation on how to design a PFC front stage using the NCP1605 controller.

## Standby Supply

An ON Semiconductor NCP1027 monolithic switcher (IC<sub>5</sub>) is used for auxiliary (or standby) power stage provide a cost effective solution, needed output power and low standby consumption, since this switcher offers skip mode capability under light load conditions. The nominal output power of this converter is 12.5 W. The unit is connected directly to the bulk capacitors so during standby conditions it operates from rectified mains. During normal operating conditions the switcher is energized by higher voltage (PFC front stage is working). After the start (that is assured by internal current supply) the switcher is powered from the auxiliary winding. Diode D<sub>23</sub> is used for rectification and capacitor C<sub>47</sub> to filter auxiliary voltage. Resistor R<sub>71</sub> limits the I<sub>CC</sub> current so the auto-recovery OVP is not activated for the correct V<sub>CC</sub> voltage. The appropriate operating bulk

voltage range is restricted by the Brown Out sensing network R<sub>64</sub>, R<sub>68</sub>, R<sub>70</sub>, R<sub>77</sub> and C<sub>48</sub>. The NCP1027 switcher features adjustable ramp compensation capability – resistor R<sub>78</sub>. Feedback loop is accomplished in the standard way: the output voltage level is regulated by the IC<sub>6</sub> to the value which is defined by resistors R<sub>74</sub> and R<sub>80</sub>. Bias current for optocoupler OK<sub>3</sub> and regulator is provided from the standby supply output using resistors R<sub>72</sub> and R<sub>73</sub>. Resistors R<sub>75</sub> and R<sub>79</sub> are used to stabilize the maximum output power level with bulk voltage evaluation (CS comparator delay compensation). A standard RCD voltage clamp (R<sub>66</sub>, R<sub>67</sub>, C<sub>41</sub>, D<sub>21</sub>) is installed on the switcher drain to limit its voltage to safe level. There is an optional layout on the board so the TVS (D<sub>19</sub>) can be used instead of the RCD clamp. This solution further decreases standby power consumption, however, price is slightly higher. Voltage from auxiliary winding, which is used to power the switcher is also used to feed up the PFC front stage and the main LLC converter control circuits. This voltage is limited by a simple zener regulator (D<sub>22</sub>, Q<sub>7</sub>, R<sub>76</sub> and C<sub>46</sub>) and can be inhibited by the OK<sub>2</sub> action. Standby mode can be activated either by positive or negative logic signals (Q<sub>5</sub> or Q<sub>6</sub> assembled). Please refer to the application note AND8241/D for a detailed explanation on how to design a Standby flyback converter using the NCP1027 switcher.

## LLC Power Stage

As previously mentioned, the NCP1396A (IC<sub>3</sub>) resonant mode controller is used to control the main SMPS unit. The power stage of the LLC converter is formed by bulk capacitors C<sub>6</sub>, C<sub>7</sub>, MOSFETs Q<sub>1</sub>, Q<sub>3</sub>, transformer TR<sub>1</sub> and resonant capacitor C<sub>11</sub>. MOSFETs are driven directly by the controller. Resistors R<sub>19</sub> and R<sub>20</sub> damp the gate charging circuit to suppress overshoots on the gates and regulate EMI noise. Bootstrap diode D<sub>14</sub> is charging the bootstrap capacitor C<sub>28</sub> via resistor R<sub>42</sub>. The bootstrap capacitor powers a floating driver when high side MOSFET is turned on. Safety resistors R<sub>4</sub> and R<sub>12</sub> are used to protect MOSFETs (during the experiments on the bench, for instance, when IC<sub>3</sub> is removed).

Center-tapped windings on 12 V and 24 V outputs increase the converter efficiency. A bridge rectifier is used for 30 V output. Different shottky diode types (D<sub>3</sub> with D<sub>5</sub>, D<sub>6</sub> through D<sub>10</sub> and D<sub>11</sub>) are used for secondary rectification according to output voltage, power losses and also short circuit capability (not to damage diode during hard short on the output). The low ESR, high temperature electrolytic capacitors C<sub>1</sub> through C<sub>4</sub>, C<sub>8</sub> through C<sub>10</sub>, C<sub>12</sub> through C<sub>16</sub>, together with inductors L<sub>1</sub>, L<sub>4</sub>, and L<sub>5</sub> serve as filters for corresponding outputs. The secondary voltage regulator IC<sub>2</sub> regulates the output voltage to 24 V, which is value adjusted by resistor divider composed by R<sub>24</sub>, R<sub>48</sub> and R<sub>49</sub>. If needed, there can be optionally used feedback from other secondary output(s) (R<sub>26</sub> and R<sub>27</sub> are included in the board layout). On the primary side, the optocoupler works in the connection with a common collector which also allows an easy implementation of the current regulation loop. Maximum

current through the optocoupler transistor is adjusted by a resistor R<sub>33</sub>. To speed up the regulation response, resistor R<sub>47</sub> is connected to the feedback pin.

Capacitor C<sub>34</sub> defines the soft start length. Note that the current regulation loop is used in this power stage so it takes control during the startup and affects the soft start action. Resistors R<sub>53</sub>, R<sub>55</sub> and R<sub>57</sub> define maximum operating frequency, minimum operating frequency and dead time. The operation/fault time period during the overload is dictated by C<sub>35</sub> and R<sub>54</sub> values.

The LLC power stage operation is conditioned to the correct PFC front stage operation indicated by the PFC OK signal. This signal, divided down by resistors R<sub>32</sub> and R<sub>56</sub>, enables the NCP1396A controller when the bulk voltage is in the right range (PFC stage reached regulation).

Resistor divider R<sub>51</sub> and R<sub>58</sub> with bypass capacitor C<sub>37</sub> are used to prepare skip mode during light or no load conditions on the power stage output. This skip mode limits the maximum needed operating frequency of the converter and improves no load efficiency of the LLC stage.

As already mentioned, the current feedback loop is used in this design. It limits the primary current of the power stage during overload and helps to implement hick-up mode. Primary current is sensed using charge pump R<sub>17</sub>, C<sub>18</sub>, D<sub>12</sub>, D<sub>13</sub>. Output of this charge pump is divided and filtered by R<sub>31</sub>, R<sub>18</sub> and C<sub>17</sub>. Maximum value of this voltage (and thus also the primary current) is regulated to 1.24 V by IC<sub>4</sub> regulator. The compensation of current regulation loop is accomplished by C<sub>31</sub> capacitor. Zener diode D<sub>15</sub> is used to lower maximum voltage on IC<sub>4</sub>. Since we need to bring up the NCP1396 feedback pin to increase the operating frequency during overload, transistor Q<sub>4</sub> with resistors R<sub>38</sub> and R<sub>44</sub> are used to perform inversion. Output voltage on the Q<sub>4</sub> collector is limited by zener diode D<sub>18</sub> to 7.5 V maximally. This voltage divided down by resistors R<sub>52</sub> and R<sub>59</sub> triggers the slow fault input in case of an overload and also drives the NCP1396A feedback pin via diode D<sub>17</sub>. This diode assures that the slow fault input is not triggered during light load conditions and in skip mode when the IC<sub>3</sub> feedback pin voltage is pushed up by the voltage feedback loop.

Controller IC<sub>3</sub> receives the V<sub>CC</sub> voltage from standby stage during normal operation mode. Auxiliary winding of the resonant transformer W<sub>7</sub> (when half wave rectified by D<sub>1</sub>) helps to power the control circuits when load on the standby supply output is too low and there is a lack of voltage on the standby auxiliary winding due to pure flyback transformer coupling. Please note that all outputs of the converter (including standby stage) are referenced to one secondary ground (S\_GND).

### LLC Transformer and Resonant Tank

A transformer from the standard production of the Pulse engineering company has been used for this design. This transformer, which is specially designed for LLC

converters, offers extra high leakage inductance value thanks to a special windings arrangement (see evaluation board photo in Figure 24). The leakage inductance serves as a resonant inductance, which results in a cost effective solution since no additional inductor is needed to form a resonant tank. Specified parameters of the mentioned transformer are as follows:

Leakage (Resonant) Inductance	L <sub>s</sub> = 115 μH
Magnetizing Inductance	L <sub>m</sub> = 450 μH
Primary Turns Count	38
24 V Output Turns Count	4
12 V Output Turns Count	2
30 V Output Turns Count	5
Auxiliary Winding Turns Count	3
Lm/Ls Ratio	450/115 = 3.9

Low value of the L<sub>m</sub>/L<sub>s</sub> ratio together with high turns ratio of the transformer will result in the high gain values.

Note that the manufacturer specifies the L<sub>s</sub> inductance in a standard way – all secondary windings are shorted during the L<sub>s</sub> measurements. This approach is OK for a transformer that has one secondary winding, but in our case we have three different secondary windings and two of them are center taped so only one of the corresponding winding participates on the resonance during one half of the switching period. As a result, the real leakage inductance that participates on the resonance is higher. Due to this fact, the simulation results of gain characteristics that are accomplished based on the transformer datasheet values, are not accurate enough to determine operating frequency range of the proposed converter.

The most accurate method how to obtain gain characteristics of the LLC converter that uses integrated transformer solution with multiple outputs, is to use a gain-phase analyzer. To do so it is necessary to load measured transformer outputs by equivalent AC resistances before measurements (first fundamental approximation – see [5] and [6]). For the center taped windings connect the AC resistance only to one of the windings of the pair – this will happen in reality – only one diode conducts the current during one half of the switching period. The AC resistance for corresponding output can be calculated using Equation 1.

$$R_{ac} = \frac{8}{\pi^2} \frac{V_{out} + V_f}{I_{out}} \quad (\text{eq. 1})$$

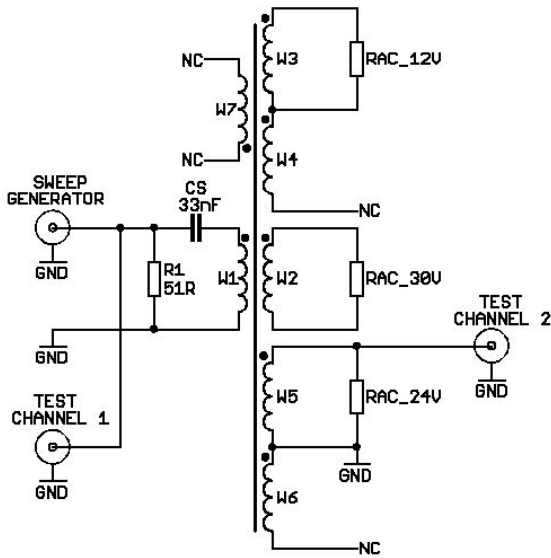
Where:

V<sub>out</sub> is the DC output voltage for given output

V<sub>f</sub> is the rectifier forward voltage

I<sub>out</sub> is the DC output current from given output

The output current has to be selected based on what type of gain characteristics one wants to obtain – full load, 10% load etc. Connection of the transformer during the gain characteristics measurements can be seen in Figure 2.



**Figure 2. Transformer Connection During Gain Characteristics Measurements**

The resonant tank quality factor of  $Q = 4.3$  (that corresponds to resonant capacitor  $C_r = 33$  nF) has been selected for this design in order to narrow operating frequency range of the converter.

The measured full load gain characteristic for the selected resonant tank components and 24 V output can be observed in Figure 3.

The gains that are needed to assure line regulation can be calculated using Equations 2 through 4:

$$G_{\min} = \frac{2(V_{\text{out}} + V_f)}{V_{\text{inmax}}} = \frac{2(24 + 0.6)}{425} = 0.116 \quad (\text{eq. 2})$$

$$G_{\text{nom}} = \frac{2(V_{\text{out}} + V_f)}{V_{\text{innom}}} = \frac{2(24 + 0.6)}{395} = 0.125 \quad (\text{eq. 3})$$

$$G_{\max} = \frac{2(V_{\text{out}} + V_f)}{V_{\text{inmax}}} = \frac{2(24 + 0.6)}{350} = 0.141 \quad (\text{eq. 4})$$

Theoretical series resonant frequency can also be calculated based on the Equation 5:

$$f_{r1} = \frac{1}{2 \cdot \pi \cdot \sqrt{L_r \cdot C_r}} \quad (\text{eq. 5})$$

$$= \frac{1}{2 \cdot 3.14 \cdot \sqrt{115 \cdot 10^{-6} \cdot 33 \cdot 10^{-9}}} = 81.7 \text{ kHz}$$

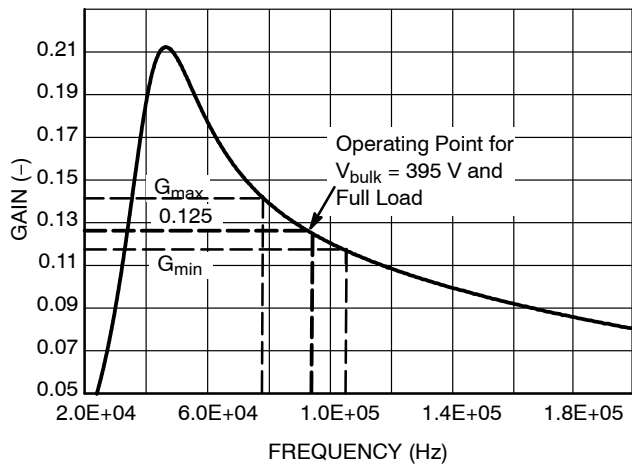
Now, when looking back to the gain characteristic in Figure 3, the operating conditions of the full loaded LLC power stage can be read:

- The nominal operating frequency of such converter is 94.6 kHz (for nominal bulk voltage)

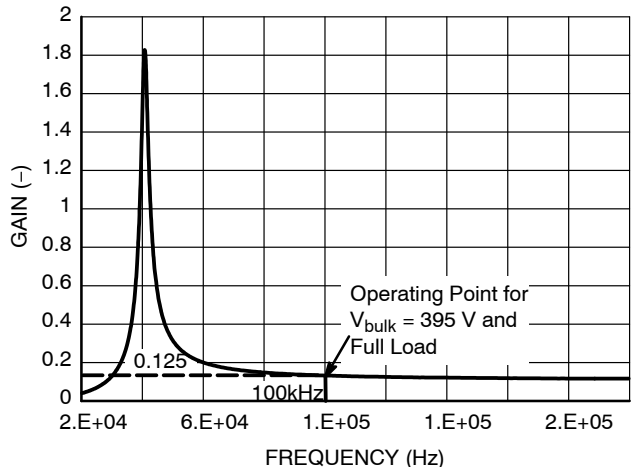
- The minimum needed operating frequency to assure low line regulation is 79 kHz
- The maximum needed operating frequency to assure high line regulation is 106 kHz
- The converter will operate in the calculated series resonant frequency for  $V_{\text{bulk}} = 360$  VDC

As demonstrated, the converter will operate above the calculated theoretical series resonant frequency for nominal bulk voltage and full load. The ZCS capability is thus not achieved on the secondary diodes. Also the needed operating frequency range of this converter is very narrow, which is beneficial for LCD TV application – EMI radiation and filtering.

Gain characteristic of this converter for  $I_{\text{load}} = 0.10 \cdot I_{\text{max}}$  and same parameters as above is in Figure 4.



**Figure 3. FLLC Converter Gain Characteristic for Full Load and  $Q = 4.3$  ( $C_r = 33$  nF)**



**Figure 4. LLC Converter gain Characteristic for 10 % Load Conditions**



# NCP1605LCDTVGEVB

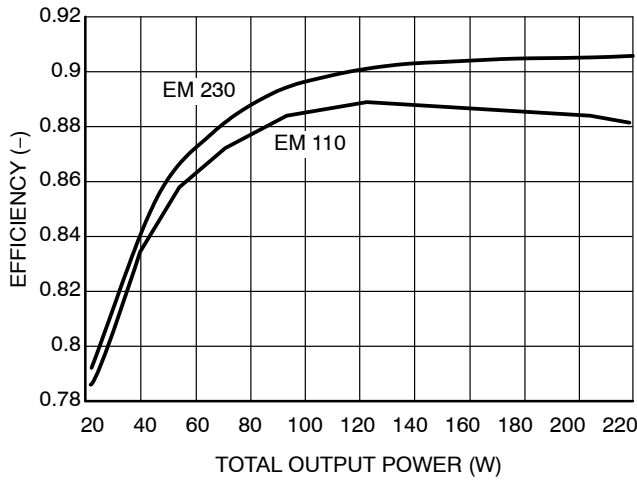
This characteristic shows that the operating frequency has to be increased above 100 kHz to maintain regulation under light load conditions. Skip mode for the LLC stage can thus be easily implemented when maximum frequency is limited by  $F_{max}$  adjust resistor value.

Please refer to the application notes AND8255/D and AND8257/D for further information about the LLC converter resonant tank components design.

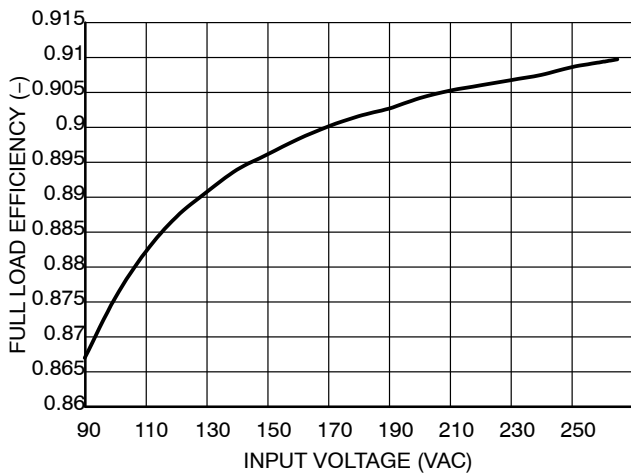
## Results Summarization

Operating frequency of real LLC stage is 96.1 kHz for full load and  $V_{bulk} = 395$  VDC, which is very close to the theoretical expectations. Output current level during which the skip mode takes place (LLC stage) has been set approximately to 8 W by  $R_{50}$ ,  $R_{57}$  divider. The PFC stage enters skip mode for output power lower than 25 W and leaves it for  $P_{out} > 30$  W.

Measured efficiency for different input voltages and load conditions can be seen in Figures 5 and 6.

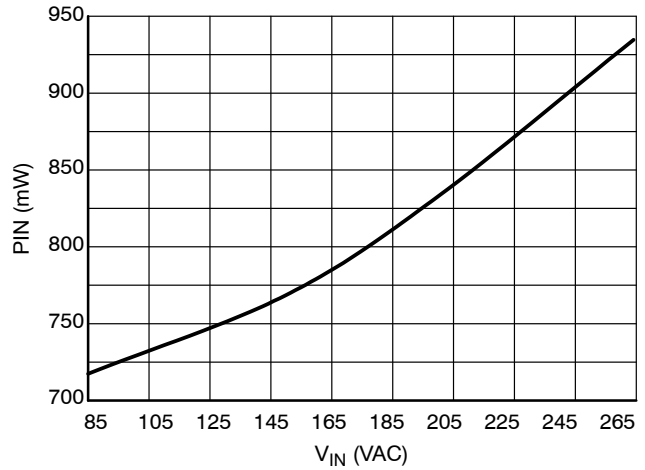


**Figure 5. Total Efficiency versus Output Power and Line**



**Figure 6. Total Full Load Efficiency versus Input Voltage**

Standby (PFC and LLC disabled) consumption characteristic with line voltage for 0.5 W load on the standby output is in Figure 7. The consumption is below 1 W for any input voltage so today's energy agency's needs are easily met thanks to this design.



**Figure 7. Standby Consumption versus Line Voltage - 0.5 W Load on STB Output**

# NCP1605LCDTVGEVB

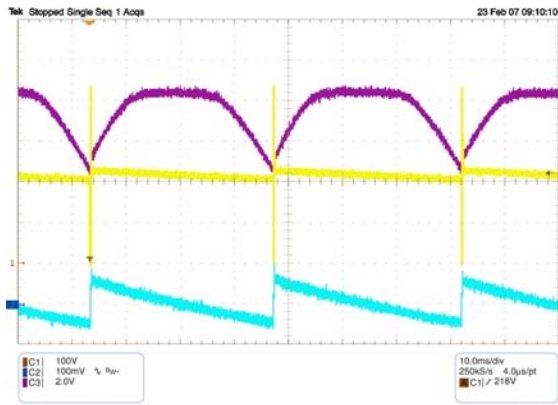


Figure 8. LLC Converter Waveforms During Skip Mode (1 – Bridge Voltage, 2 – Output Ripple on 12 V Output, 3 – Feedback Pin of the NCP1396)

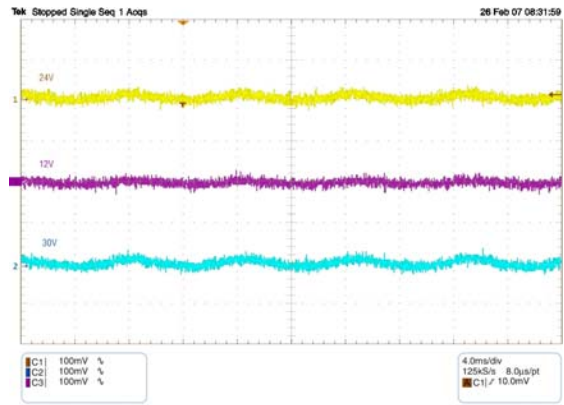


Figure 9. Output Ripple on Each LLC Stage Output for Full Load Conditions (1 – 24 V Output, 2 – 30 V Output, 3 – 12 V Output)

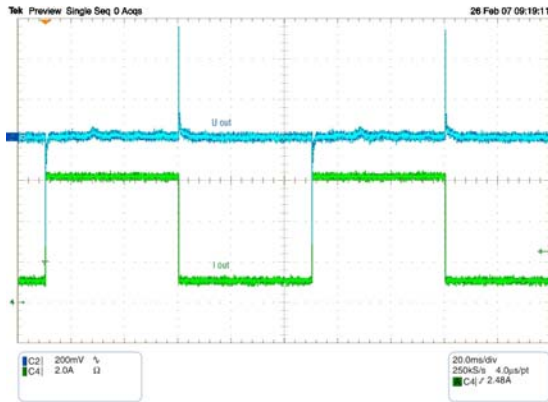


Figure 10. LLC Stage Load Regulation for 230 V Input Voltage (2 – Output Voltage on the 24 V Output, 4 – Output Current from the 24 V Output)

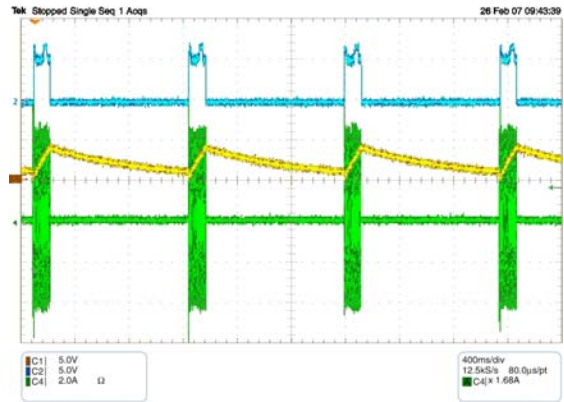


Figure 11. LLC Stage Operating Under Short Circuit (1 – Ctimer Voltage, 2 – Feedback Voltage, 4 – Primary Current)

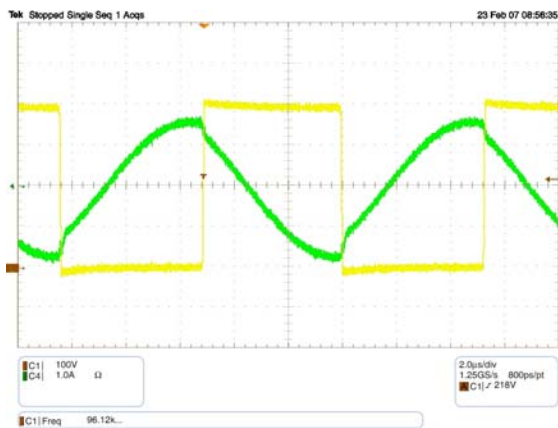


Figure 12. LLC Stage Full Load Operation (1 – Bridge Voltage, 4 – Primary Current)

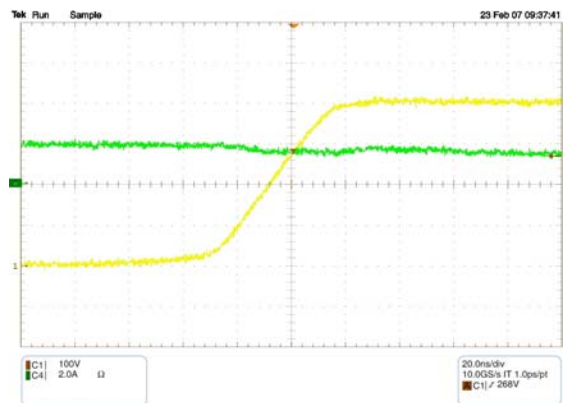
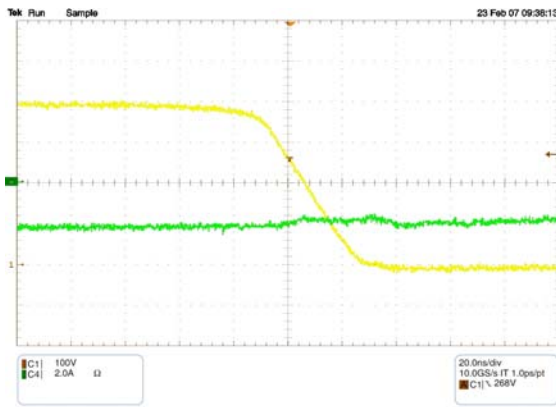
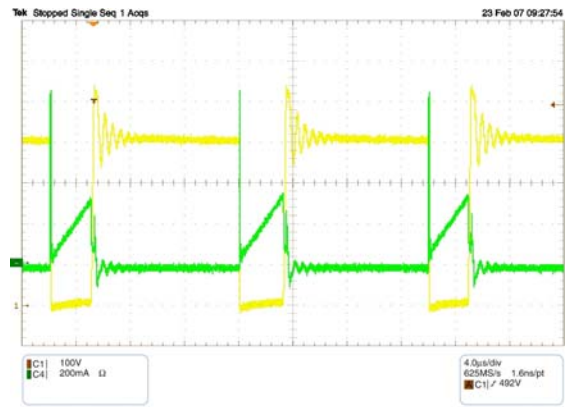


Figure 13. Detail of the ZVS Condition on the Bridge – Rising Edge (1 – Bridge Voltage, 4 – Primary Current)

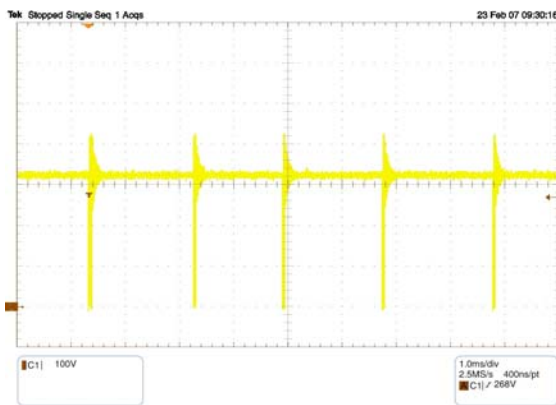
# NCP1605LCDTVGEVB



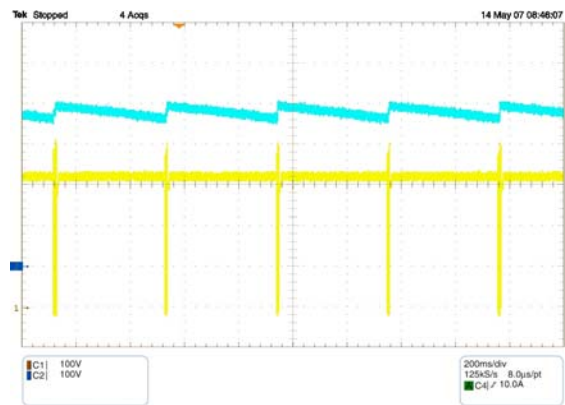
**Figure 14. Detail of the ZVS Condition on the Bridge – Falling Edge (1 – Bridge Voltage, 4 – Primary Current)**



**Figure 15. Standby Power Supply Waveforms – Full Loaded (1 – NCP1027 Drain Voltage, 4 – Drain Current)**



**Figure 16. Standby Power Supply Waveforms – No Load Conditions (1 – NCP1027 Drain Voltage)**



**Figure 17. PFC Stage Skip Mode (1 – Q2 Drain Voltage, 2 – Bulk Voltage)**

## Layout Consideration

Leakage inductance on the primary side is not very critical for the LLC converter compared to other topologies, because it will only slightly modify the resonant frequency. However it is well to keep the areas of each power loop as small as possible due to radiated EMI noise. A two-sided PCB with one side ground plane helps (see Figures 21 and 23).

## Thanks

I would like to thank the PULSE engineering company for provided samples and support for magnetic components used in this board.

I would also like to thank the COILCRAFT company for providing samples of the filtering inductors.

## CAUTION

This evaluation board is intended for demonstration and evaluation purposes only and not for the end customer.

## Literature

1. NCP1396A/B data sheet
2. NCP1605 data sheet
3. NCP1027 data sheet
4. Application note AND8241/D
5. Application note AND8255/D

6. Application note AND8257/D
7. Application note AND8281/D
8. Bo Yang – Topology Investigation for Front End DC-DC Power Conversion for Distributed Power System
9. M. B. Borage, S. R. Tiwari and S. Kotaiah – Design Optimization for an LCL – Type Series Resonant Converter
10. Pulse Engineering – Transformer specification, No: 2652.0017A
11. Pulse Engineering – Transformer specification, No: 2362.0031B
12. Pulse Engineering – PFC inductor specification, No: 2702.0012A

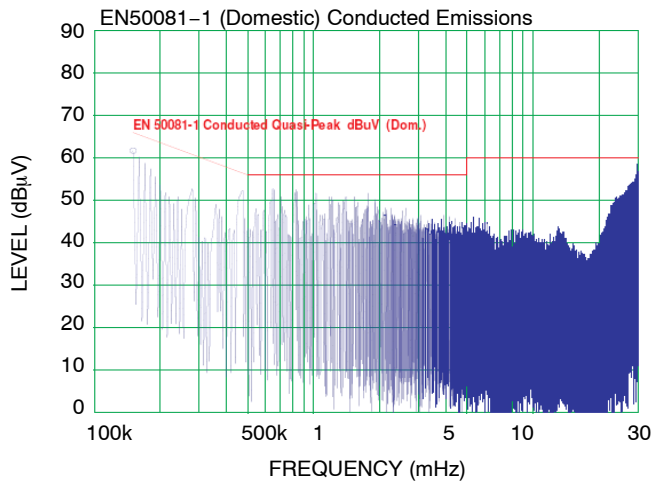
Please contact Pulse Engineering Company regarding literature 10 – 12:

Pulse European Headquarters  
Einsteinstrasse 1  
71083 Herrenberg  
Germany

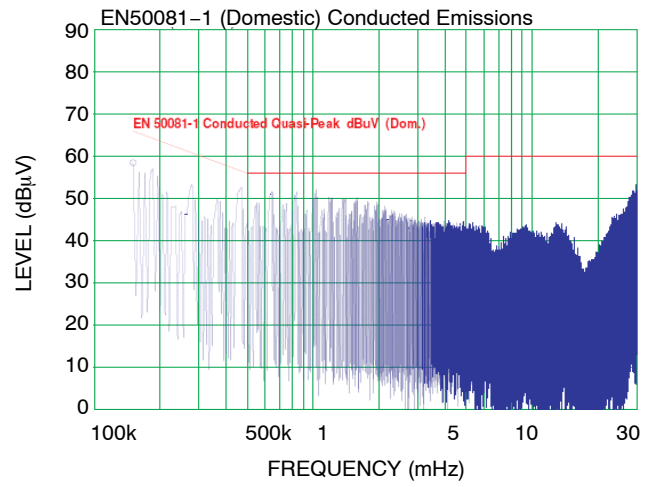
TEL: 49 7032 7806 0  
FAX: 49 7032 7806 12



# NCP1605LCDTVGEVB



**Figure 18. Conducted EMI Signature of the Board for Full Load and 230 VAC Input**



**Figure 19. Conducted EMI Signature of the Board for Full Load and 110 VAC Input**

# NCP1605LCDTVGEVB

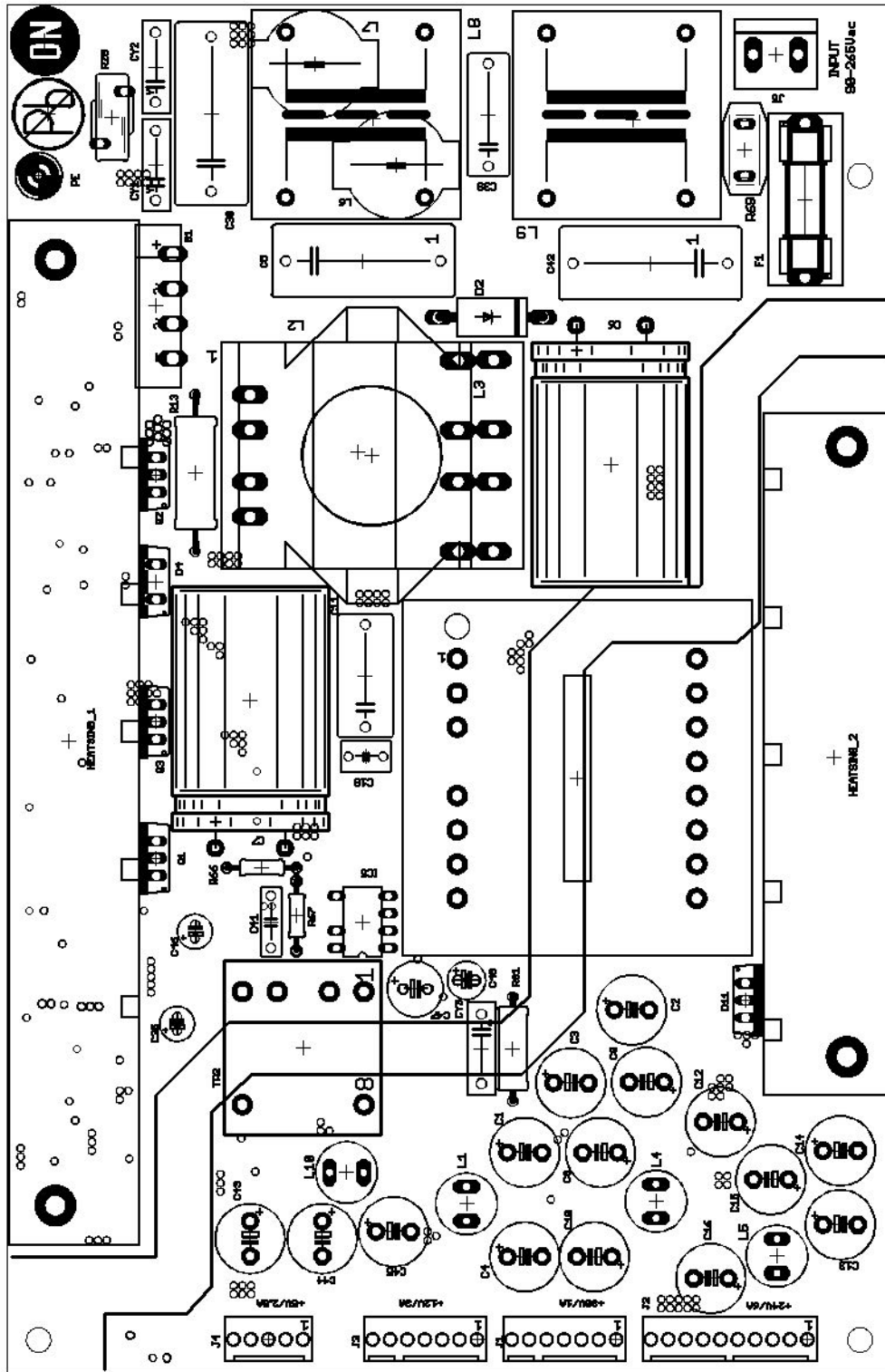


Figure 20. Component Placement on the Top Side (Top View)

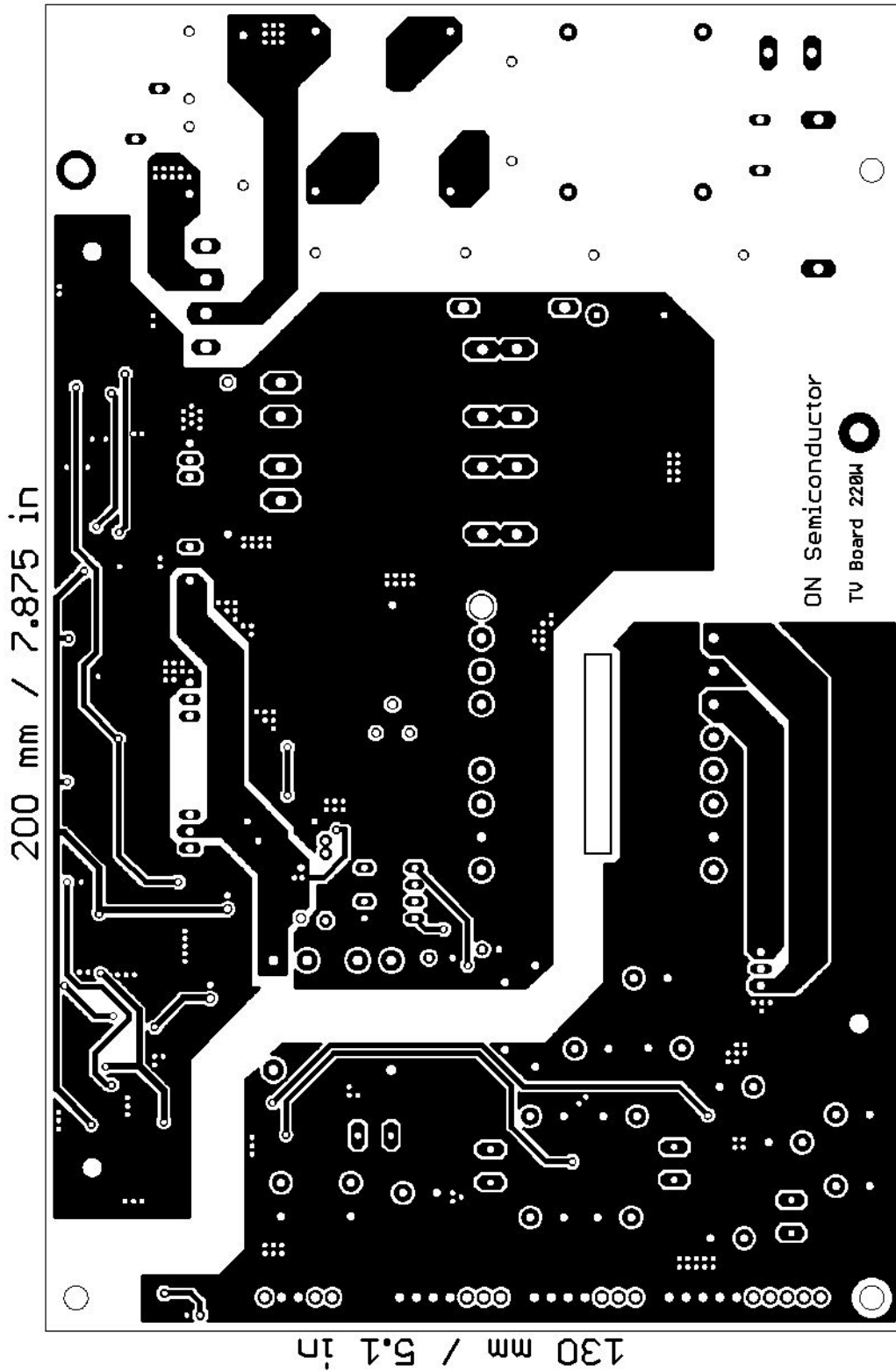


Figure 21. Top Side (Top View)

# NCP1605LCDTVGEVB

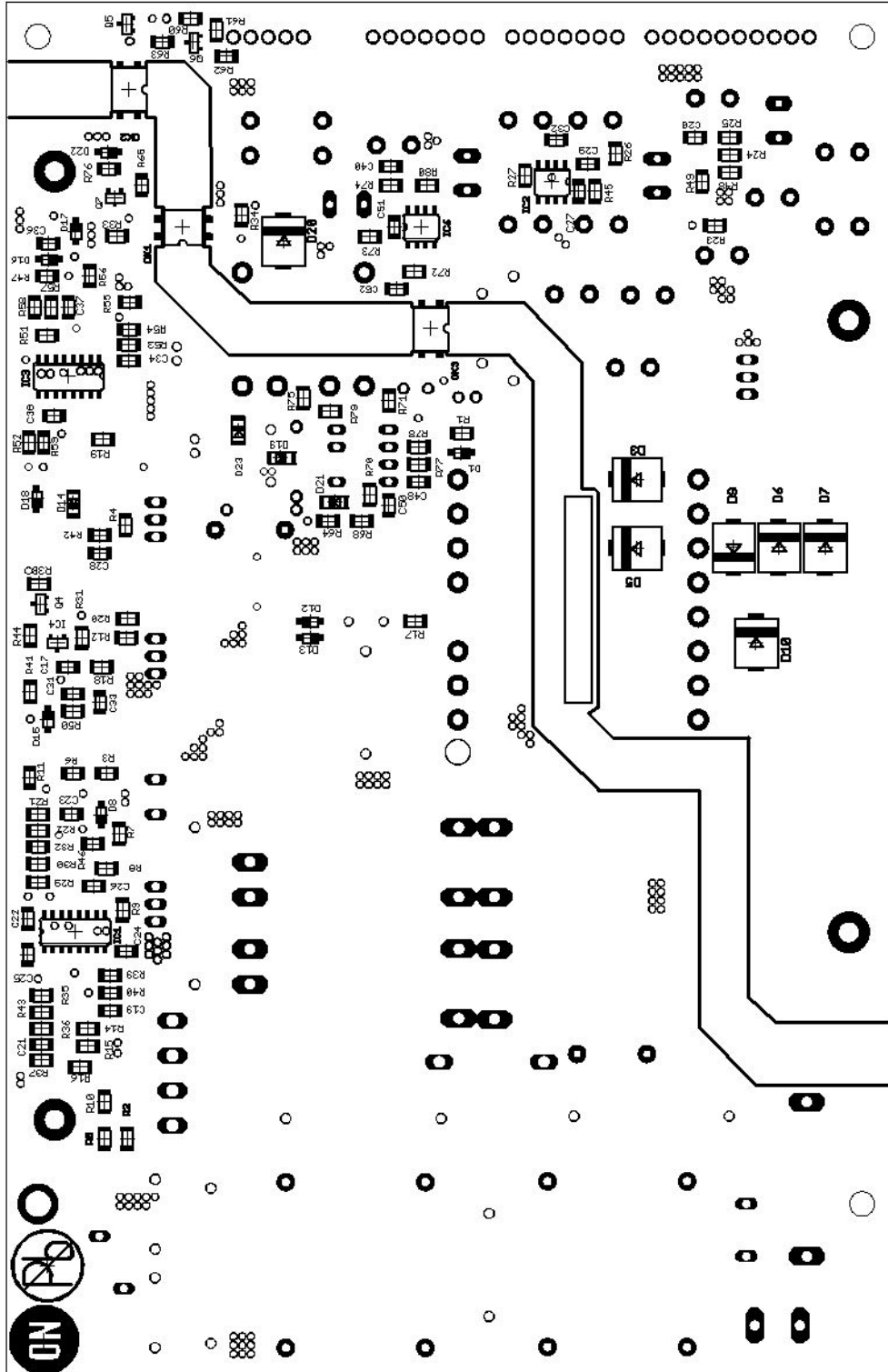


Figure 22. Component Placement on the Bottom Side (Bottom View)

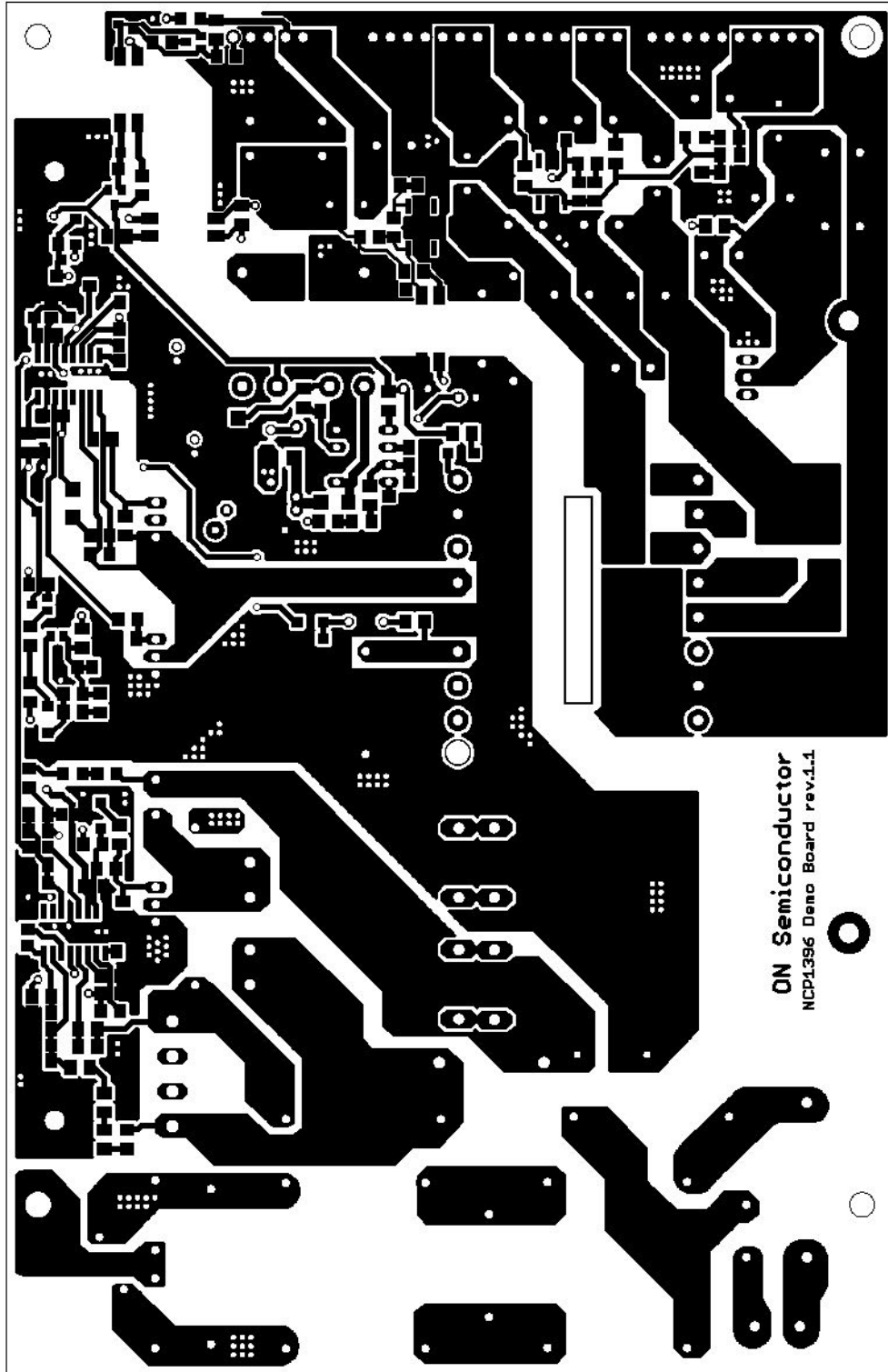


Figure 23. Bottom Side (Bottom View)



# NCP1605LCDTVGEVB



Figure 24. Photo of the Designed Prototype (Real Dimensions are 200 x 130 mm)

# NCP1605LCDTVGEVB

## BILL OF MATERIAL

Designator	Qty	Description	Value	Tolerance	Footprint	Manufacturer	Manufacturer Part Number	Substitution Allowed
B1	1	Bridge Rectifier	KBU8M		KBU	Fairchild	KBU8M	Yes
C1, C2, C3, C8, C9, C12, C13, C14, C15, C43, C44	11	Electrolytic Capacitor	470 $\mu$ F / 35 V	20%	CPOL-EUE5-10.5	Rubycon	35ZL470M10X20	Yes
C10	1	Electrolytic Capacitor	220 $\mu$ F / 63 V	10%	CPOL-EUE5-10.5	Rubycon	63 YXA220M 10x16	Yes
C11	1	MKP Capacitor	33 nF / 630 Vdc	20%	C-EU150-084X183	Arcotronics	R73-0.033 $\mu$ F 15 630V	Yes
C16	1	Electrolytic Capacitor	220 $\mu$ F / 35 V	20%	CPOL-EUE5-10.5	Rubycon	35 RX30220M 10x12.5	Yes
C17, C48	2	Ceramic Capacitor SMD	10n	10%	C-EUC1206	Epcos	B37872A5103K060	Yes
C18	1	Ceramic Capacitor	220p	10%	C-EU050-045X075	Panasonic	ECKA3A221KBP	Yes
C19	1	Ceramic Capacitor SMD	8n2	10%	C-EUC1206	Epcos	B37872A5822K060	Yes
C20, C23, C32, C33, C36, C52	6		NU		C-EUC1206			Yes
C21	1	Ceramic Capacitor SMD	150n	10%	C-EUC1206	Epcos	B37872A5154K060	Yes
C22	1	Ceramic Capacitor SMD	220n	10%	C-EUC1206	Epcos	B37872A5224K060	Yes
C24	1	Ceramic Capacitor SMD	390p	5%	C-EUC1206	Epcos	B37871K5391J060	Yes
C25	1	Ceramic Capacitor SMD	1n2	10%	C-EUC1206	Epcos	B37872A5122K060	Yes
C26, C28, C38, C40, C51	5	Ceramic Capacitor SMD	100n	10%	C-EUC1206	Epcos	B37872A5104K060	Yes
C27	1	Ceramic Capacitor SMD	1n	10%	C-EUC1206	Epcos	B37872A5102K060	Yes
C29	1	Ceramic Capacitor SMD	22n	10%	C-EUC1206	Epcos	B37872A5223K060	Yes
C31	1	Ceramic Capacitor SMD	68n	10%	C-EUC1206	Epcos	B37872A5683K060	Yes
C34	1	Ceramic Capacitor SMD	1 $\mu$ F	10%	C-EUC1206	Epcos	B37872K0105K062	Yes
C35	1	Electrolytic Capacitor	4 $\mu$ 7/35V	20%	CPOL-EUE2-5	Rubycon	35 MH54.7M 4x5	Yes
C37	1	Ceramic Capacitor SMD	2n2	10%	C-EUC1206	Epcos	B37872A5222K060	Yes
C39	1		NU		C-EU150-064X183			
C4, C45	2	Electrolytic Capacitor	220 $\mu$ F / 25 V	20%	CPOL-EUE5-10.5	Rubycon	25 NXA220M 10x12.5	Yes
C41	1	MKP Capacitor	10 nF / 630 Vdc	20%	C-EU075-032X103	Epcos	B32560J8103M000	Yes
C46	1	Electrolytic Capacitor	1u	20%	CPOL-EUE2-5	Rubycon	50 MH51M 4x5	Yes
C47	1	Electrolytic Capacitor	100 $\mu$ F / 35 V	20%	CPOL-EUE5.5-8	Rubycon	50 PK100M 8x11.5	Yes
C49	1	Electrolytic Capacitor	10 $\mu$ F / 35 V	20%	CPOL-EUE2.5-6	Rubycon	50 MH710M 6.3x7	Yes
C5, C30, C42	3	MKP Capacitor	1 $\mu$ F / 275 Vac	20%	C-EU225-108X268	Arcotronics	R46KM410000N1M	Yes

NOTE: Please see the NCP1396A/B product folder on [www.onsemi.com](http://www.onsemi.com) for PCB Gerber files and other collateral information regarding this evaluation board.

**All components are Lead Free.**

# NCP1605LCDTVGEVB

## BILL OF MATERIAL

Designator	Qty	Description	Value	Tolerance	Footprint	Manufacturer	Manufacturer Part Number	Substitution Allowed
C50	1	Ceramic Capacitor SMD	100p	20%	C-EUC1206	Epcos	B37871K5101J060	Yes
C6	1	Electrolytic Capacitor	100 $\mu$ F / 450 V	20%	EC18L40'22L35'	Rubycon	450 VXG100M 22x30	Yes
C7	1	Electrolytic Capacitor	100 $\mu$ F / 450 V	20%	EC18L40'22L35_90'	Rubycon	450 VXG100M 22x30	Yes
CY1, CY2, CY3	3	Ceramic Capacitor	2n2/Y1	20%	CYYC10B4	Murata	DE1E3KX222MA5B	Yes
D1, D8, D12, D13, D17	5	Diode	MMSD4148		SOD-123	ON Semiconductor	MMSD4148T1G	No
D11	1	Dual Diode	MBRF20100CT		TO-220	ON Semiconductor	MBRF20100CTG	No
D14, D21, D23	3	Diode	MURA160SMD		SMA	ON Semiconductor	MURA160T3G	No
D15	1	Zener Diode	3V3	5%	SOD-123	ON Semiconductor	MMSZ3V3T1G	No
D16	1		NU		SOD-123			
D18	1	Zener Diode	7V5	5%	SOD-123	ON Semiconductor	MMSZ7V5T1G	No
D19	1		NU		SMA			
D2	1	Diode	1N5408		Axial Lead 9.50x5.30mm	ON Semiconductor	1N5408G	No
D20	1	Diode	MBRS340T3		SMC	ON Semiconductor	MBRS320T3G	No
D22	1	Zener Diode	18V	5%	SOD-123	ON Semiconductor	MMSZ18T1G	No
D3, D5, D6, D7, D9, D10	6	Diode	MBRS4201T3G		SMC	ON Semiconductor	MBRS4201T3G	No
D4	1	Diode	MSR860		TO-220	ON Semiconductor	MSR860G	No
F1	1	FUSEHOLDER , 20X5MM	SH22, 5A		SH22, 5A	Multicomp	MCHTC-15M	Yes
	1	COVER, PCB FUSEHOLDER				Multicomp	MCHTC-150M	Yes
	1	FUSE, MEDIUM DELAY 4A	4A			BUSSMANN	TDC 210-4A	Yes
HEATSING _1	1	Heatsing	SK 454 150 SA		SK454/150_GND	Fischer Elektronik	SK 454 150 SA	Yes
HEATSING _2	1	Heatsing	SK 454 100 SA		SK454/100_GND	Fischer Elektronik	SK 454 100 SA	Yes
IC1	1	PFC Controller	NCP1605		SOIC 16	ON Semiconductor	NCP1605DR2G	No
IC2, IC6	2	Programmable Precision Reference	TL431SO8		SOIC-8	ON Semiconductor	NCV431AIDR2G	No
IC3	1	Resonant Controller	NCP1396A		SOIC 16	ON Semiconductor	NCP1396ADR2G	No
IC4	1	Programmable Precision Reference	TLV431A		SOT-23	ON Semiconductor	TLV431ASN1T1G	No
IC5	1	HV Switcher for Medium Power Offline SMPS	NCP1027		PDIP (8 Minus Pin 6)	ON Semiconductor	NCP1027P065G	No
J1, J3	2	Connector	22-23-2071		MOLEX-7PIN	Molex	22-23-2071	Yes

NOTE: Please see the NCP1396A/B product folder on [www.onsemi.com](http://www.onsemi.com) for PCB Gerber files and other collateral information regarding this evaluation board.  
**All components are Lead Free.**

# NCP1605LCDTVGEVB

## BILL OF MATERIAL

Designator	Qty	Description	Value	Tolerance	Footprint	Manufacturer	Manufacturer Part Number	Substitution Allowed
J2	1	Connector	22-23-2101		MOLEX-10PIN	Molex	22-23-2101	Yes
J4	1	Connector	22-23-2051		MOLEX-5PIN	Molex	22-23-2051	Yes
J5	1	Connector	LP7.5/2/903.2 OR		Weidmueller	Weidmueller	LP7.5/2/903.2 OR	Yes
L1, L4, L5, L10	4	Inductor	2 $\mu$ 2	20%	RFB0807	Coilcraft	RFB0807-2R2L	No
L2	1	Inductor	2702.0012A (260 $\mu$ H)	15%	Pulse_2702	Pulse	2702.0012A	Yes
L3	1		NU		2722.0005A			
L6, L7	2	Inductor	100 $\mu$	20%	DO5040H_100	Coilcraft	DO5040H-104MLB	No
L8	1		NU		TLBI			
L9	1	EMI Filter	7mH	15%	TLBI	Pulse	6001.0069	No
OK1, OK2, OK3	3	Opto-Coupler	PC817		PC817SMD	Avago Technologies	HCPL-817-300E	Yes
Q1, Q3	2	MOSFET Transistor	STP12NM50FP		TO-220	STMicroelectronics	STP12NM50FP	Yes
Q2	1	MOSFET Transistor	STP20NM60FP		TO-220	STMicroelectronics	STP12NM50FP	Yes
Q4	1	PNP General Purpose Transistor	BC856-16LT1		SOT-23	ON Semiconductor	BC856-16LT1G	No
Q5, Q7	2	NPN General Purpose Transistor	BC817-16LT1		SOT-23	ON Semiconductor	BC817-16LT1G	No
Q6	1		NU		SOT-23			
R1, R8, R19, R20	4	Resistor SMD	10R	1%	R-EU_R1206	Vishay	RCA120610R0FKEA	Yes
R13	1	Resistor Trough Hole	0.1R	1%	R-EU_0617/22	Vishay	PAC300001007FAC000	Yes
R14	1	Resistor SMD	7k5	1%	R-EU_R1206	Vishay	RCA12067K50FKEA	Yes
R15, R51	2	Resistor SMD	8k2	1%	R-EU_M1206	Vishay	RCA12068K20FKEA	Yes
R17	1	Resistor SMD	47k	1%	R-EU_M1206	Vishay	RCA120647K0FKEA	Yes
R18	1	Resistor SMD	1k6	1%	R-EU_M1206	Vishay	RCA12061K60FKEA	Yes
R2, R5, R10, R16	4	Resistor SMD	1M8	1%	R-EU_M1206	Vishay	RCA12061M80FKEA	Yes
R21, R25, R26, R27, R37, R46, R50	7	Resistor SMD	NU	1%	R-EU_M1206	Vishay		Yes
R22	1	Resistor SMD	1k1	1%	R-EU_M1206	Vishay	RCA12061K10FKEA	Yes
R23, R33, R34, R38, R41, R73	6	Resistor SMD	1k	1%	R-EU_M1206	Vishay	RCA12061K00FKEA	Yes
R24, R77	2	Resistor SMD	18k	1%	R-EU_M1206	Vishay	RCA120618K0FKEA	Yes
R28	1	Varistor	VDRH10S275TSE		VARISTOR10K300	Vishay	2381 584 T271S	Yes
R29	1	Resistor SMD	33k	1%	R-EU_M1206	Vishay	RCA120633K0FKEA	Yes
R3, R6, R11	3	Resistor SMD	1M3	1%	R-EU_R1206	Vishay	RCA12061M30FKEA	Yes
R30	1	Resistor SMD	91k	1%	R-EU_M1206	Vishay	RCA120691K0FKEA	Yes
R31, R48	2	Resistor SMD	3k3	1%	R-EU_M1206	Vishay	RCA12063K30FKEA	Yes
R32, R39, R55	3	Resistor SMD	15k	1%	R-EU_R1206	Vishay	RCA12061K50FKEA	Yes
R36	1	Resistor SMD	62k	1%	R-EU_M1206	Vishay	RCA120662K0FKEA	Yes

NOTE: Please see the NCP1396A/B product folder on [www.onsemi.com](http://www.onsemi.com) for PCB Gerber files and other collateral information regarding this evaluation board.

**All components are Lead Free.**

# NCP1605LCDTVGEVB

## BILL OF MATERIAL

Designator	Qty	Description	Value	Tolerance	Footprint	Manufacturer	Manufacturer Part Number	Substitution Allowed
R4, R9, R12, R35, R43, R44, R52, R57, R61, R74, R79, R80	12	Resistor SMD	10k	1%	R-EU_M1206	Vishay	RCA120610K0FKEA	Yes
R40	1	Resistor SMD	150R	1%	R-EU_R1206	Vishay	RCA1206150RFKEA	Yes
R42	1	Resistor SMD	18R	1%	R-EU_R1206	Vishay	RCA120618R0FKEA	Yes
R45	1	Resistor SMD	2k7	1%	R-EU_M1206	Vishay	RCA12062K70FKEA	Yes
R47	1	Resistor SMD	2k2	1%	R-EU_R1206	Vishay	RCA12062K20FKEA	Yes
R49	1	Resistor SMD	5k6	1%	R-EU_M1206	Vishay	RCA12065K60FKEA	Yes
R53	1	Resistor SMD	24k	1%	R-EU_R1206	Vishay	RCA120624K0FKEA	Yes
R54	1	Resistor SMD	150k	1%	R-EU_R1206	Vishay	RCA1206150KFKEA	Yes
R56	1	Resistor SMD	6k8	1%	R-EU_R1206	Vishay	RCA12066K80FKEA	Yes
R58	1	Resistor SMD	1k5	1%	R-EU_R1206	Vishay	RCA12061K50FKEA	Yes
R59	1	Resistor SMD	6k2	1%	R-EU_R1206	Vishay	RCA12066K20FKEA	Yes
R60, R62, R63	3	Resistor SMD	820R	1%	R-EU_R1206	Vishay	RCA1206820RFKEA	Yes
R64, R68	2	Resistor SMD	1M2	1%	R-EU_R1206	Vishay	RCA12061M20FKEA	Yes
R65	1	Resistor SMD	4k7	1%	R-EU_R1206	Vishay	RCA12064K70FKEA	Yes
R66	1	Resistor Trough Hole	150k	1%	R-EU_0207/10	Vishay	MRS25000C1503FCT	Yes
R67	1	Resistor Trough Hole	47R	1%	R-EU_0207/10	Vishay	MRS25000C4709FCT	Yes
R69	1	Option for Thermistor	0R0		P594			
R7	1	Resistor SMD	0R0	1%	R-EU_M1206	Vishay	RCA12060000FKEA	Yes
R70	1	Resistor SMD	180k	1%	R-EU_M1206	Vishay	RCA1206180KFKEA	Yes
R71	1	Resistor SMD	3k9	1%	R-EU_M1206	Vishay	RCA12063K90FKEA	Yes
R72	1	Resistor SMD	100R	1%	R-EU_M1206	Vishay	RCA1206100RFKEA	Yes
R75	1	Resistor SMD	360k	1%	R-EU_M1206	Vishay	RCA1206360KFKEA	Yes
R76	1	Resistor SMD	470k	1%	R-EU_R1206	Vishay	RCA1206470KFKEA	Yes
R78	1	Resistor SMD	75k	1%	R-EU_M1206	Vishay	RCA120675K0FKEA	Yes
R81	1	Resistor Trough Hole, High Voltage	4M7	5%	R-EU_0414/15	Vishay	VR37000004704JA100	Yes
TR1	1	Resonant Transformer	2652.0017A	15%	2652	Pulse	2652.0017A	No
TR2	1	Standby Transformer	2362.0031B	15%	2362	Pulse	2362.0031B	No

NOTE: Please see the NCP1396A/B product folder on [www.onsemi.com](http://www.onsemi.com) for PCB Gerber files and other collateral information regarding this evaluation board.

**All components are Lead Free.**



# NCP1605LCDTVGEVB

## TEST PROCEDURE FOR THE NCP1605 LCD EVALUATION BOARD

### Necessary Equipment:

- 1 Current limited  $90 \div 265$  Vrms AC source (current limited to avoid board destruction in case of a defective part) or a 380 VDC source (AGILENT 6811)
- 1 AC Volt-Meter able to measure up to 300 V AC. (KEITHLEY 2000)
- 1 AC Amp-Meter able to measure up to 3 A AC. (KEITHLEY 2000)
- 4 DC Volt-Meter able to measure up to 50 V DC. (KEITHLEY 2000)
- 4 DC Amp-Meter able to measure up to 5 A DC. (KEITHLEY 2000)
- 4 DC Electronic Load 0 - 60 A (AGILENT 6060B)

### Test Procedure

1. Connect the test setup as shown in Figure 25.
2. Apply an input voltage,  $U_{in} = 90 - 265$  Vac
3. Apply  $I_{out}(\text{load}) = 0$  A
4. Check that  $U_{out}$  is 24; 12 V; 30 V; 5 V
5. Increase  $I_{out}(\text{load})$  load to: 24 V / 6 A; 12 V / 3 A; 30 V / 1 A; 5 V / 2.5 A
6. Check that  $U_{out}$  is 24; 12 V; 30 V; 5 V
7. Power down the load
8. Power down  $U_{in}$
9. End of test

NOTE: Be careful when manipulating the boards in operation, lethal voltages up to 425 V are present on the primary side. An isolation transformer is also recommended for safer manipulations.

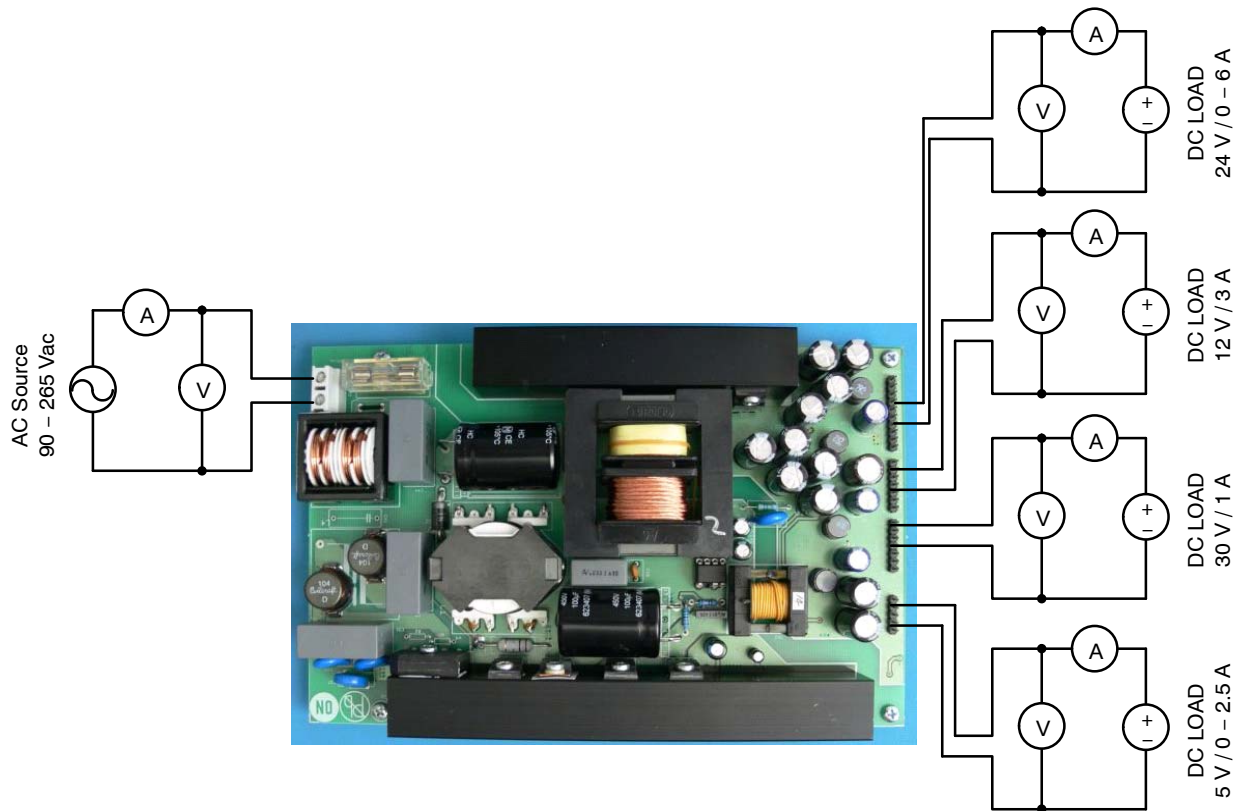



Figure 25. Test Setup

**ON Semiconductor** and  are registered trademarks of Semiconductor Components Industries, LLC (SCILLC). SCILLC owns the rights to a number of patents, trademarks, copyrights, trade secrets, and other intellectual property. A listing of SCILLC's product/patent coverage may be accessed at [www.onsemi.com/site/pdf/Patent-Marking.pdf](http://www.onsemi.com/site/pdf/Patent-Marking.pdf). SCILLC reserves the right to make changes without further notice to any products herein. SCILLC makes no warranty, representation or guarantee regarding the suitability of its products for any particular purpose, nor does SCILLC assume any liability arising out of the application or use of any product or circuit, and specifically disclaims any and all liability, including without limitation special, consequential or incidental damages. "Typical" parameters which may be provided in SCILLC data sheets and/or specifications can and do vary in different applications and actual performance may vary over time. All operating parameters, including "Typicals" must be validated for each customer application by customer's technical experts. SCILLC does not convey any license under its patent rights nor the rights of others. SCILLC products are not designed, intended, or authorized for use as components in systems intended for surgical implant into the body, or other applications intended to support or sustain life, or for any other application in which the failure of the SCILLC product could create a situation where personal injury or death may occur. Should Buyer purchase or use SCILLC products for any such unintended or unauthorized application, Buyer shall indemnify and hold SCILLC and its officers, employees, subsidiaries, affiliates, and distributors harmless against all claims, costs, damages, and expenses, and reasonable attorney fees arising out of, directly or indirectly, any claim of personal injury or death associated with such unintended or unauthorized use, even if such claim alleges that SCILLC was negligent regarding the design or manufacture of the part. SCILLC is an Equal Opportunity/Affirmative Action Employer. This literature is subject to all applicable copyright laws and is not for resale in any manner.

## PUBLICATION ORDERING INFORMATION

### LITERATURE FULFILLMENT:

Literature Distribution Center for ON Semiconductor  
P.O. Box 5163, Denver, Colorado 80217 USA  
**Phone:** 303-675-2175 or 800-344-3860 Toll Free USA/Canada  
**Fax:** 303-675-2176 or 800-344-3867 Toll Free USA/Canada  
**Email:** [orderlit@onsemi.com](mailto:orderlit@onsemi.com)

**N. American Technical Support:** 800-282-9855 Toll Free  
USA/Canada  
**Europe, Middle East and Africa Technical Support:**  
Phone: 421 33 790 2910  
**Japan Customer Focus Center**  
Phone: 81-3-5817-1050

**ON Semiconductor Website:** [www.onsemi.com](http://www.onsemi.com)  
**Order Literature:** <http://www.onsemi.com/orderlit>  
For additional information, please contact your local  
Sales Representative