



EMIF04-EAR02M8

4-line IPAD™ EMI filter and ESD protection for headset

Features

- lead-free package
- high attenuation: -30 dB at 900 MHz
- low cut-off frequencies: 60 MHz for speaker lines
- high current capability: 50 mA per line
- very low PCB space consumption: 1.5 mm x 1.7 mm
- very thin package: 0.6 mm maximum
- high efficiency in ESD suppression IEC6 1000-4-2 level 4
- high reliability offered by monolithic integration

Complies with following standards:

- IEC 61000-4-2 level 4 all pins:
 - 15 kV (air discharge)
 - 8 kV (contact discharge)

Application

- mobile phones

Description

The EMIF04-EAR02M8 chip is a highly integrated device designed to suppress EMI/RFI noise for mobile phone headsets. The new LC architecture on the speaker lines provides a high attenuation value maintaining a very low serial resistance.

The μ QFN-8L package offers the possibility to integrate the whole function in a very small PCB space.

Additionally, this filter includes ESD protection circuitry, which prevents damage to the protected device when subjected to ESD surges up to 30 kV.

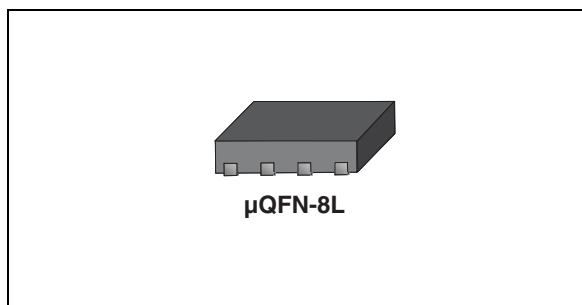

Figure 1. Pin configuration (bottom side)

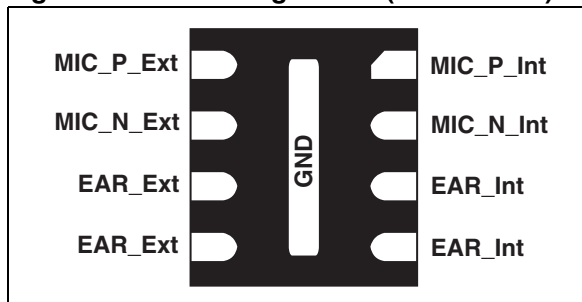
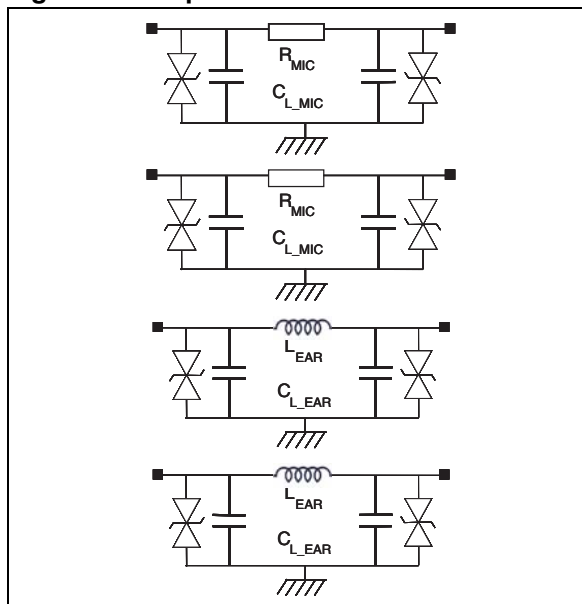

Figure 2. Equivalent circuit



TM: IPAD is a trademark of STMicroelectronics

1 Characteristics

Table 1. Absolute maximum ratings ($T_{amb} = 25\text{ }^{\circ}\text{C}$)

| Symbol | Parameter | Value | Unit |
|-----------|------------------------------------|-------------|--------------------|
| V_{PP} | ESD IEC 61000-4-2 air discharge | 30 | kV |
| | contact discharge | 30 | |
| I_{EAR} | Maximum rms current per channel | 50 | mA |
| T_j | Operating junction temperature | -30 to 125 | $^{\circ}\text{C}$ |
| T_{stg} | Storage temperature range | -55 to +150 | $^{\circ}\text{C}$ |

Figure 3. Electrical symbols and parameters

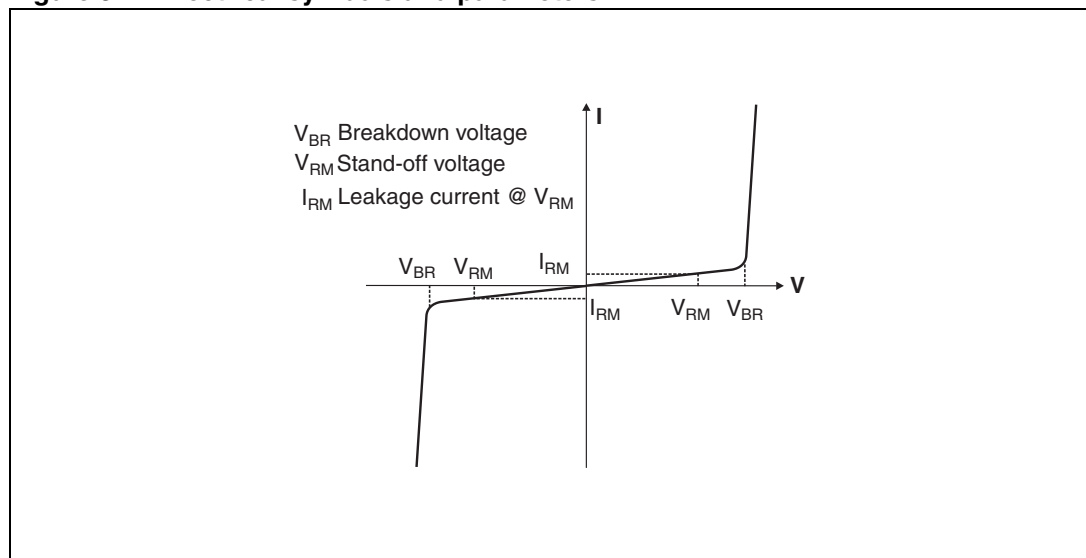

Table 2. Electrical characteristics ($T_{amb} = 25\text{ }^{\circ}\text{C}$)

| Symbol | Test conditions | Min. | Typ. | Max. | Unit |
|--------------|--|------|------|------|----------|
| V_{BR} | $I_R = 1\text{ mA}$ | 7 | | | V |
| I_{RM} | $V_{RM} = 3\text{ V}$ | | | 100 | nA |
| L_{EAR} | | | 1.5 | | nH |
| R_L | Parasitic resistance of inductor L_{EAR} | | 0.30 | 0.6 | Ω |
| R_{MIC} | | 54 | 68 | 82 | Ω |
| C_{L_EAR} | $V_R = 0\text{ V DC}$, 1 MHz | 84 | 105 | 126 | pF |
| C_{L_MIC} | $V_R = 0\text{ V DC}$, 1 MHz | 60 | 76 | 92 | pF |
| F_{c_EAR} | Cut-off frequency earphone line: $Z_{SOURCE} = Z_{LOAD} = 50\ \Omega$ | | 60 | | MHz |
| F_{c_MIC} | Cut-off frequency microphone line: $Z_{SOURCE} = Z_{LOAD} = 50\ \Omega$ | | 70 | | MHz |

Figure 4. S21 attenuation measurement

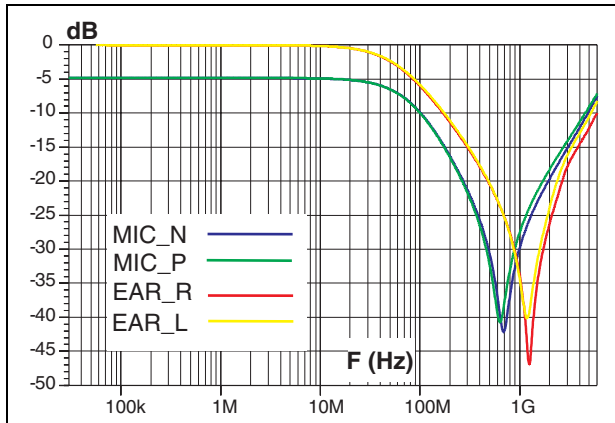

Figure 5. Analog cross talk measurements

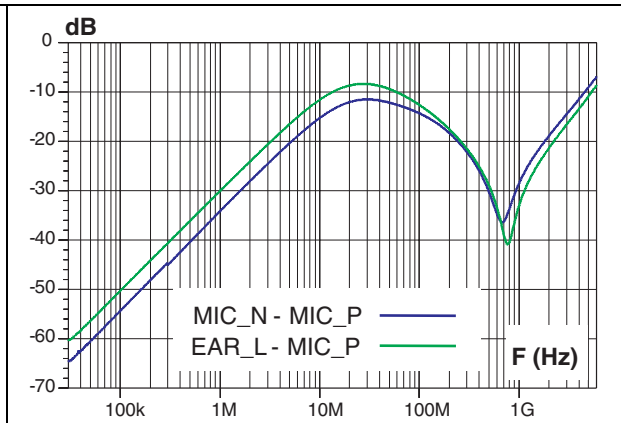

Figure 6. ESD response to IEC 61000-4-2 (+15 kV air discharge) on one MIC input (V_{in}) and on one MIC output

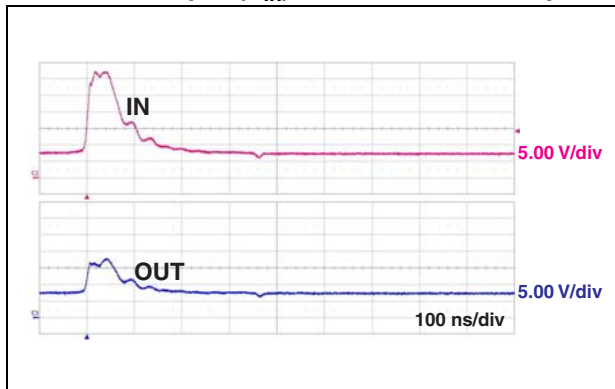

Figure 7. ESD response to IEC 61000-4-2 (-15 kV air discharge) on one MIC input (V_{in}) and on one MIC output

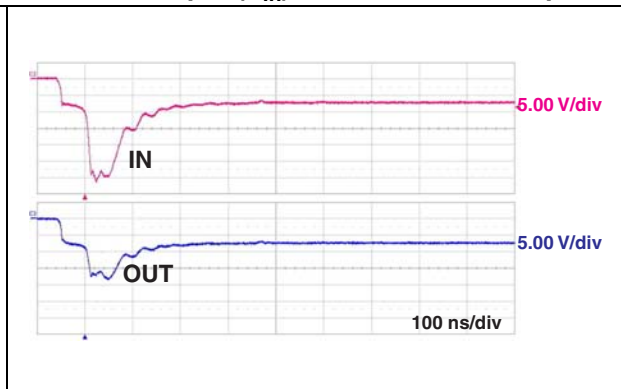

Figure 8. ESD response to IEC 61000-4-2 (+15 kV air discharge) on one EAR input (V_{in}) and on one EAR output

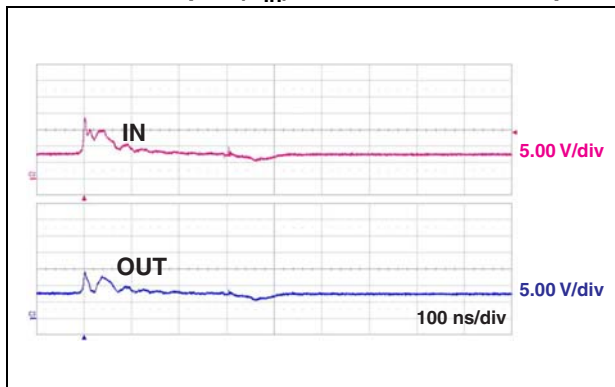

Figure 9. ESD response to IEC 61000-4-2 (-15 kV air discharge) on one EAR input (V_{in}) and on one EAR output

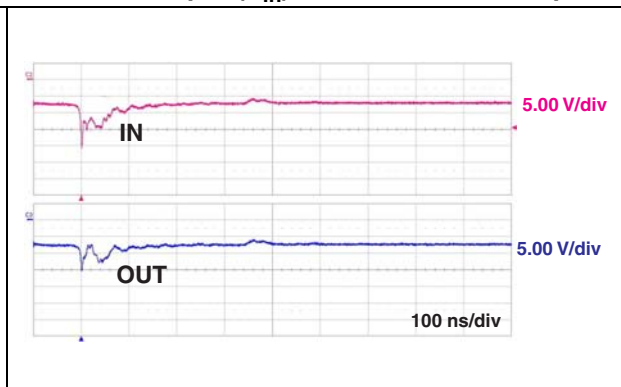

Figure 10. Relative line capacitance variation versus applied voltage

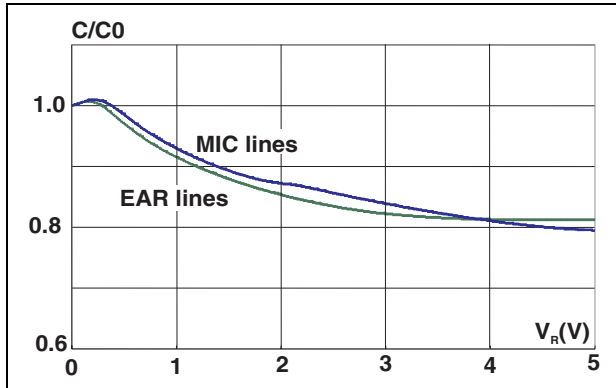

Figure 11. Total harmonic distortion with noise: MIC lines, R = 10 kΩ

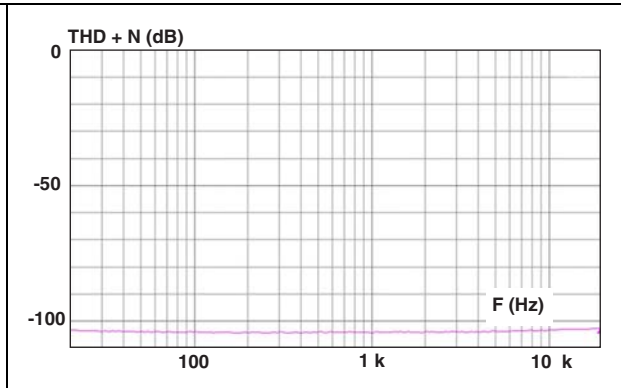

Figure 12. Total harmonic distortion with noise: MIC lines, R = 32 Ω

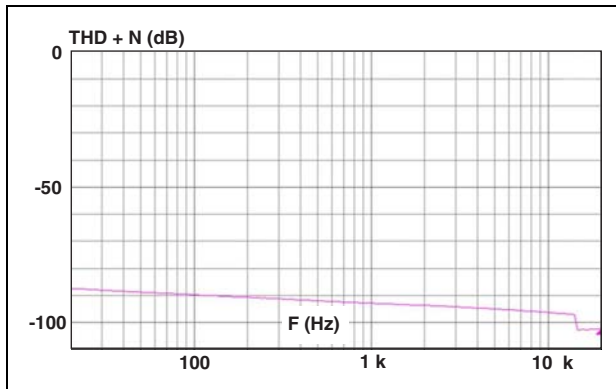

Figure 13. Total harmonic distortion with noise: EAR lines, R = 32 Ω

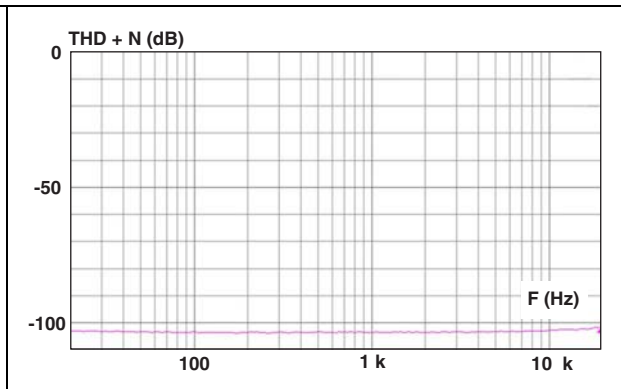
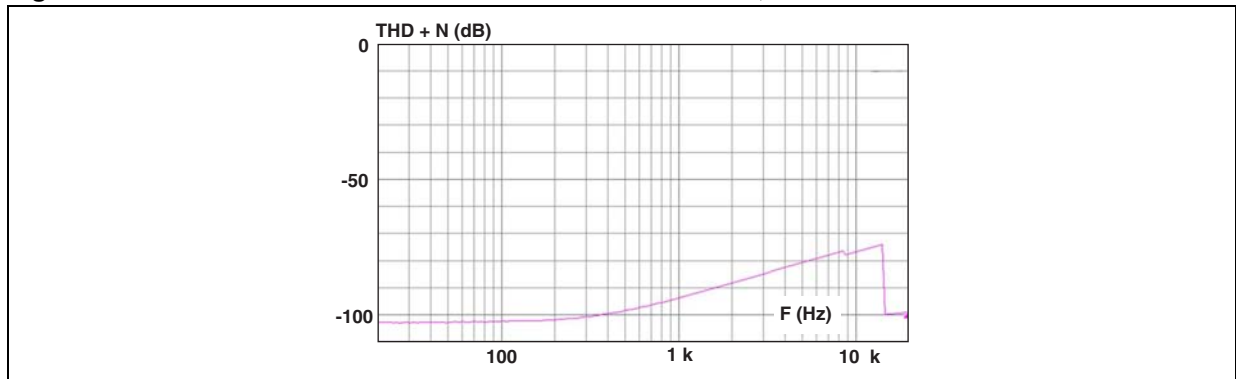
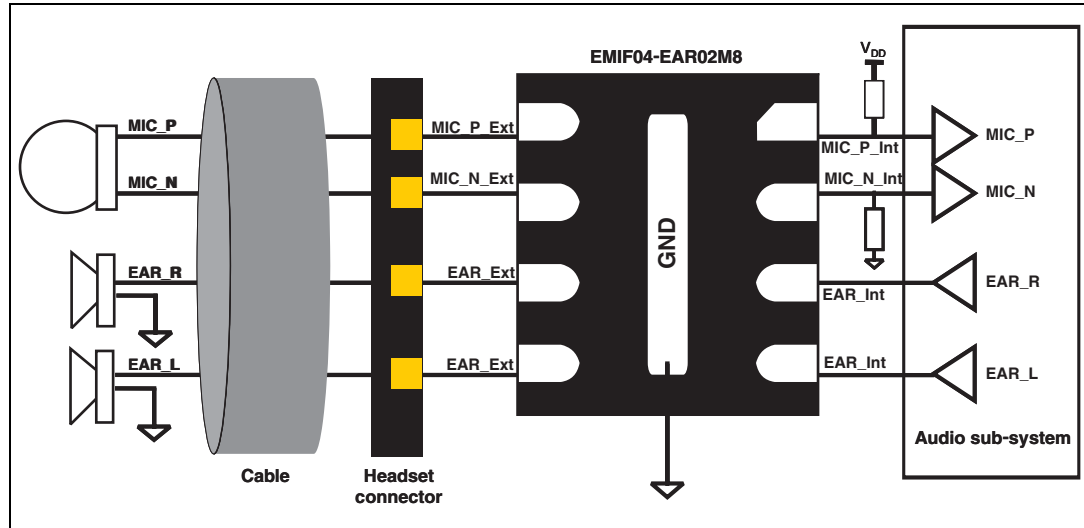

Figure 14. Total harmonic distortion with noise: EAR lines, R = 8 Ω



2 Application information

Figure 15. Example of application scheme using EMIF04-EAR02M8



3 Ordering information scheme

Figure 16. Ordering information scheme

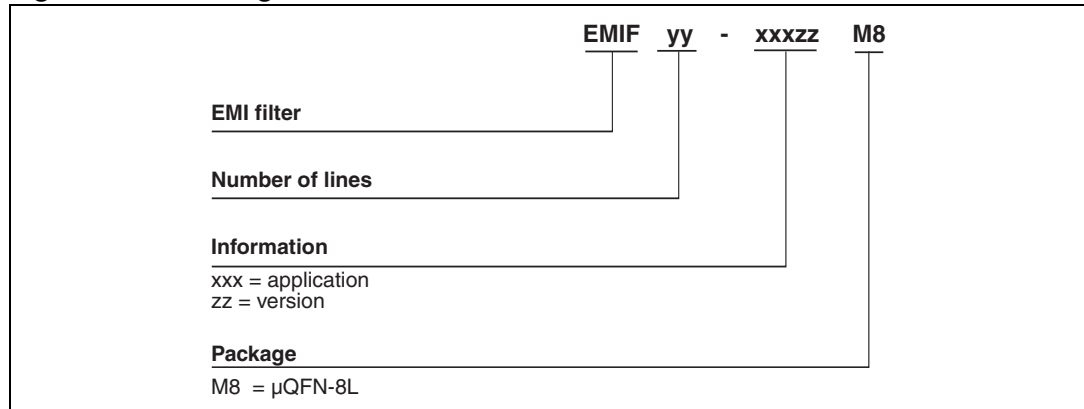

4 Package information

- Epoxy meets UL94, V0
- Lead-free package

In order to meet environmental requirements, ST offers these devices in different grades of ECOPACK® packages, depending on their level of environmental compliance. ECOPACK® specifications, grade definitions and product status are available at: www.st.com. ECOPACK® is an ST trademark.

Table 3. μQFN-8L dimensions

| Ref. | Dimensions | | | | | |
|------|-------------|------|------|--------|-------|-------|
| | Millimeters | | | Inches | | |
| | Min. | Typ. | Max. | Min. | Typ. | Max. |
| A | 0.50 | 0.55 | 0.60 | 0.020 | 0.022 | 0.024 |
| A1 | 0.00 | 0.02 | 0.05 | 0.000 | 0.001 | 0.002 |
| b | 0.15 | 0.18 | 0.25 | 0.006 | 0.007 | 0.001 |
| D | 1.65 | 1.70 | 1.75 | | 0.067 | |
| D2 | 1.15 | 1.3 | 1.4 | 0.045 | 0.051 | 0.055 |
| E | 1.45 | 1.50 | 1.55 | | 0.059 | |
| E2 | 0.05 | 0.20 | 0.30 | 0.002 | 0.008 | 0.012 |
| e | | 0.40 | | | 0.016 | |
| k | 0.20 | | | 0.008 | | |
| L | 0.25 | 0.30 | 0.35 | 0.010 | 0.012 | 0.014 |

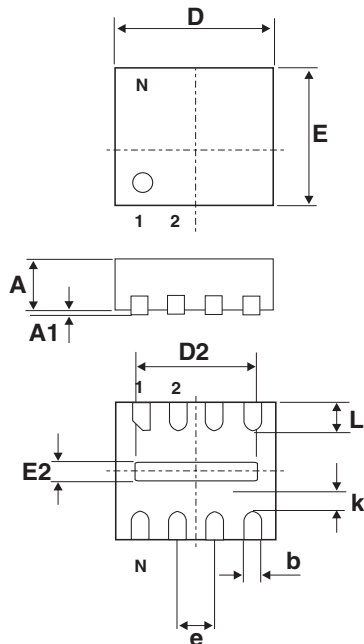

Figure 17. Footprint

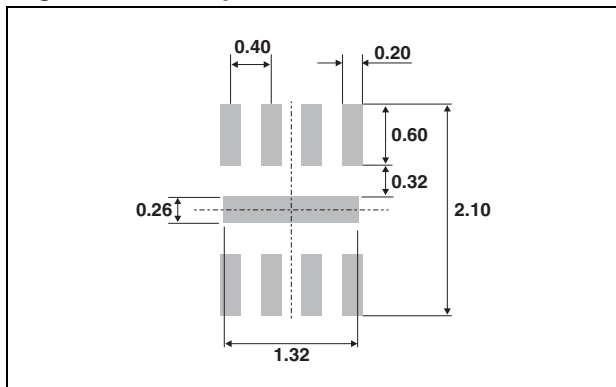

Figure 18. Marking

Dot: Pin1 identification
XX = Marking

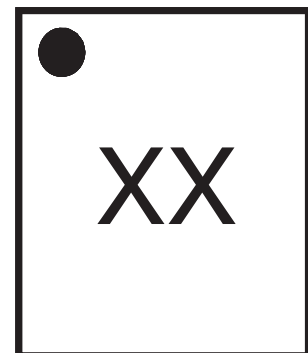
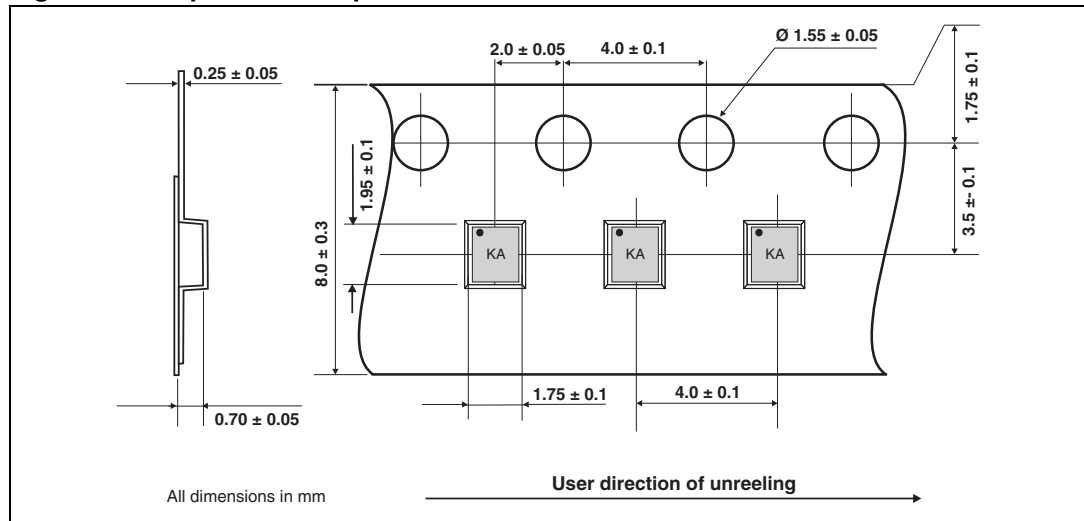

Figure 19. Tape and reel specification



Note: Product marking may be rotated by multiples of 90° for assembly plant differentiation. In no case should this product marking be used to orient the component for its placement on a PCB. Only pin 1 mark is to be used for this purpose.

5 Recommendation on PCB assembly

5.1 Stencil opening design

1. General recommendation on stencil opening design
 - a) Stencil opening dimensions: L (Length), W (Width), T (Thickness).

Figure 20. Stencil opening dimensions

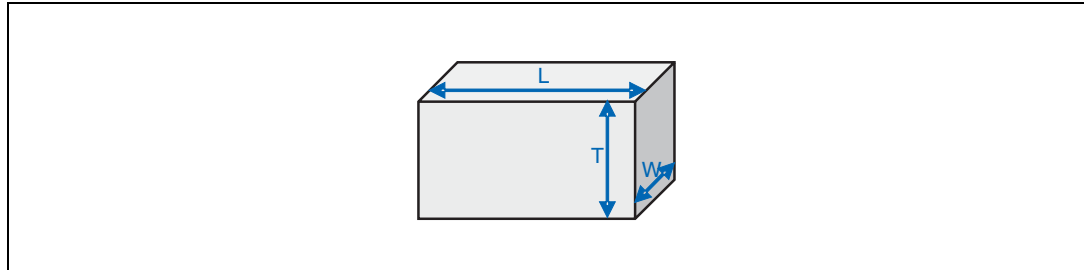

- b) General design rule
 - Stencil thickness (T) = 75 ~ 125 μm
 - Aspect Ratio = $\frac{W}{T} \geq 1.5$
 - Aspect Area = $\frac{L \times W}{2T(L + W)} \geq 0.66$

2. Reference design
 - a) Stencil opening thickness: 100 μm
 - b) Stencil opening for central exposed pad: Opening to footprint ratio is 50%.
 - c) Stencil opening for leads: Opening to footprint ratio is 90%.

Figure 21. Recommended stencil window position

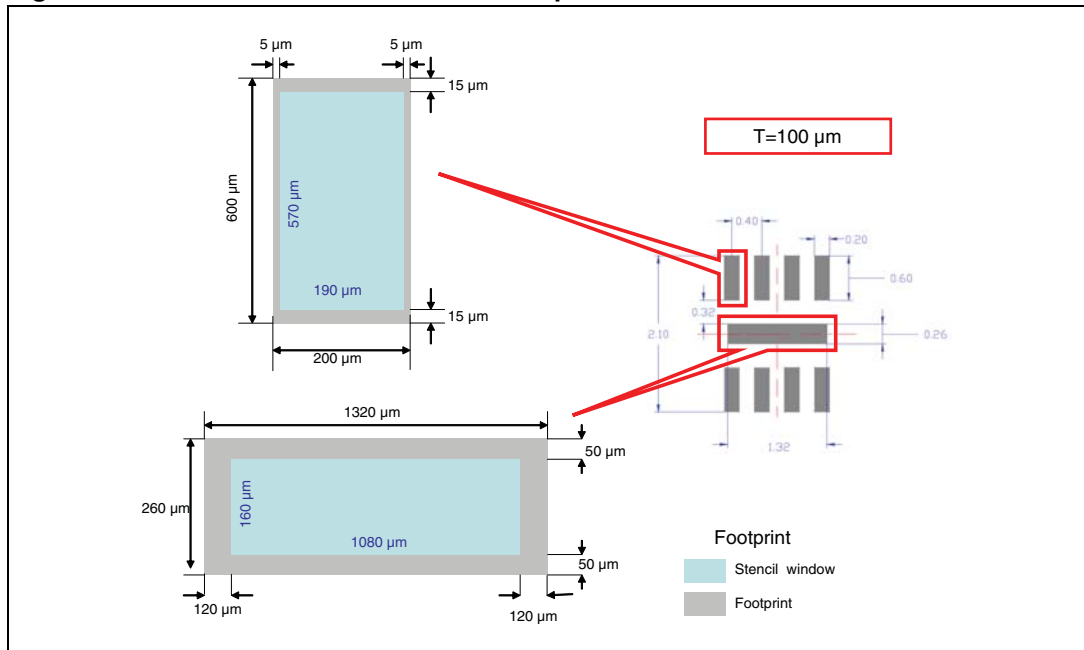

5.2 Solder paste

1. Halide-free flux qualification ROL0 according to ANSI/J-STD-004.
2. “No clean” solder paste is recommended.
3. Offers a high tack force to resist component movement during high speed
4. Solder paste with fine particles: powder particle size is 20-45 μm .

5.3 Placement

1. Manual positioning is not recommended.
2. It is recommended to use the lead recognition capabilities of the placement system, not the outline centering
3. Standard tolerance of ± 0.05 mm is recommended.
4. 3.5 N placement force is recommended. Too much placement force can lead to squeezed out solder paste and cause solder joints to short. Too low placement force can lead to insufficient contact between package and solder paste that could cause open solder joints or badly centered packages.
5. To improve the package placement accuracy, a bottom side optical control should be performed with a high resolution tool.
6. For assembly, a perfect supporting of the PCB (all the more on flexible PCB) is recommended during solder paste printing, pick and place and reflow soldering by using optimized tools.

5.4 PCB design preference

1. To control the solder paste amount, the closed via is recommended instead of open vias.
2. The position of tracks and open vias in the solder area should be well balanced. The symmetrical layout is recommended, in case any tilt phenomena caused by asymmetrical solder paste amount due to the solder flow away.

5.5 Reflow profile

Figure 22. ST ECOPACK® recommended soldering reflow profile for PCB mounting

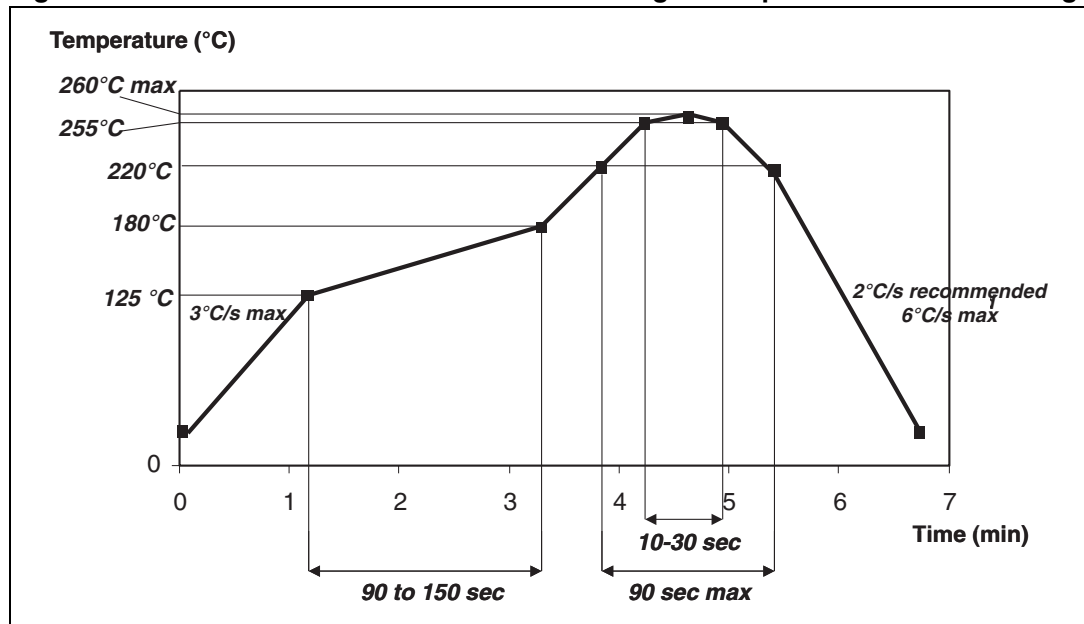

Note: Minimize air convection currents in the reflow oven to avoid component movement.

6 Ordering information

Table 4. Ordering information

| Order code | Marking | Package | Weight | Base qty | Delivery mode |
|----------------|-------------------|---------|--------|----------|---------------|
| EMIF04-EAR02M8 | KA ⁽¹⁾ | μQFN-8L | 3.8 mg | 3000 | Tape and reel |

1. The marking can be rotated by multiples of 90° to differentiate assembly location.

For the latest information on available order codes see the product pages on www.st.com.

7 Revision history

Table 5. Document revision history

| Date | Revision | Changes |
|-------------|----------|---|
| 24-Mar-2009 | 1 | Initial release |
| 02-Sep-2010 | 2 | Changed "input pins" to "all pins" in standards compliance section. Updated Figure 16 . Added paragraph in Section 6: Ordering information . |

Please Read Carefully:

Information in this document is provided solely in connection with ST products. STMicroelectronics NV and its subsidiaries ("ST") reserve the right to make changes, corrections, modifications or improvements, to this document, and the products and services described herein at any time, without notice.

All ST products are sold pursuant to ST's terms and conditions of sale.

Purchasers are solely responsible for the choice, selection and use of the ST products and services described herein, and ST assumes no liability whatsoever relating to the choice, selection or use of the ST products and services described herein.

No license, express or implied, by estoppel or otherwise, to any intellectual property rights is granted under this document. If any part of this document refers to any third party products or services it shall not be deemed a license grant by ST for the use of such third party products or services, or any intellectual property contained therein or considered as a warranty covering the use in any manner whatsoever of such third party products or services or any intellectual property contained therein.

UNLESS OTHERWISE SET FORTH IN ST'S TERMS AND CONDITIONS OF SALE ST DISCLAIMS ANY EXPRESS OR IMPLIED WARRANTY WITH RESPECT TO THE USE AND/OR SALE OF ST PRODUCTS INCLUDING WITHOUT LIMITATION IMPLIED WARRANTIES OF MERCHANTABILITY, FITNESS FOR A PARTICULAR PURPOSE (AND THEIR EQUIVALENTS UNDER THE LAWS OF ANY JURISDICTION), OR INFRINGEMENT OF ANY PATENT, COPYRIGHT OR OTHER INTELLECTUAL PROPERTY RIGHT.

UNLESS EXPRESSLY APPROVED IN WRITING BY AN AUTHORIZED ST REPRESENTATIVE, ST PRODUCTS ARE NOT RECOMMENDED, AUTHORIZED OR WARRANTED FOR USE IN MILITARY, AIR CRAFT, SPACE, LIFE SAVING, OR LIFE SUSTAINING APPLICATIONS, NOR IN PRODUCTS OR SYSTEMS WHERE FAILURE OR MALFUNCTION MAY RESULT IN PERSONAL INJURY, DEATH, OR SEVERE PROPERTY OR ENVIRONMENTAL DAMAGE. ST PRODUCTS WHICH ARE NOT SPECIFIED AS "AUTOMOTIVE GRADE" MAY ONLY BE USED IN AUTOMOTIVE APPLICATIONS AT USER'S OWN RISK.

Resale of ST products with provisions different from the statements and/or technical features set forth in this document shall immediately void any warranty granted by ST for the ST product or service described herein and shall not create or extend in any manner whatsoever, any liability of ST.

ST and the ST logo are trademarks or registered trademarks of ST in various countries.

Information in this document supersedes and replaces all information previously supplied.

The ST logo is a registered trademark of STMicroelectronics. All other names are the property of their respective owners.

© 2010 STMicroelectronics - All rights reserved

STMicroelectronics group of companies

Australia - Belgium - Brazil - Canada - China - Czech Republic - Finland - France - Germany - Hong Kong - India - Israel - Italy - Japan - Malaysia - Malta - Morocco - Philippines - Singapore - Spain - Sweden - Switzerland - United Kingdom - United States of America

www.st.com