

# MC14027B

## Dual J-K Flip-Flop

The MC14027B dual J-K flip-flop has independent J, K, Clock (C), Set (S) and Reset (R) inputs for each flip-flop. These devices may be used in control, register, or toggle functions.

### Features

- Diode Protection on All Inputs
- Supply Voltage Range = 3.0 Vdc to 18 Vdc
- Logic Swing Independent of Fanout
- Logic Edge-Clocked Flip-Flop Design
- Logic State is Retained Indefinitely with Clock Level Either High or Low; Information is Transferred to the Output Only on the Positive-Going Edge of the Clock Pulse
- Capable of Driving Two Low-Power TTL Loads or One Low-Power Schottky TTL Load Over the Rated Temperature Range
- Pin-for-Pin Replacement for CD4027B
- Pb-Free Packages are Available\*

### MAXIMUM RATINGS (Voltages Referenced to $V_{SS}$ )

Symbol	Parameter	Value	Unit
$V_{DD}$	DC Supply Voltage Range	-0.5 to +18.0	V
$V_{in}, V_{out}$	Input or Output Voltage Range (DC or Transient)	-0.5 to $V_{DD} + 0.5$	V
$I_{in}, I_{out}$	Input or Output Current (DC or Transient) per Pin	$\pm 10$	mA
$P_D$	Power Dissipation, per Package (Note 1)	500	mW
$T_A$	Ambient Temperature Range	-55 to +125	$^{\circ}C$
$T_{stg}$	Storage Temperature Range	-65 to +150	$^{\circ}C$
$T_L$	Lead Temperature (8-Second Soldering)	260	$^{\circ}C$

Maximum ratings are those values beyond which device damage can occur. Maximum ratings applied to the device are individual stress limit values (not normal operating conditions) and are not valid simultaneously. If these limits are exceeded, device functional operation is not implied, damage may occur and reliability may be affected.

#### 1. Temperature Derating:

Plastic "P and D/DW" Packages: - 7.0 mW/ $^{\circ}C$  From 65 $^{\circ}C$  To 125 $^{\circ}C$

This device contains protection circuitry to guard against damage due to high static voltages or electric fields. However, precautions must be taken to avoid applications of any voltage higher than maximum rated voltages to this high-impedance circuit. For proper operation,  $V_{in}$  and  $V_{out}$  should be constrained to the range  $V_{SS} \leq (V_{in} \text{ or } V_{out}) \leq V_{DD}$ .

Unused inputs must always be tied to an appropriate logic voltage level (e.g., either  $V_{SS}$  or  $V_{DD}$ ). Unused outputs must be left open.

\*For additional information on our Pb-Free strategy and soldering details, please download the ON Semiconductor Soldering and Mounting Techniques Reference Manual, SOLDERRM/D.



ON Semiconductor®

<http://onsemi.com>

### MARKING DIAGRAMS

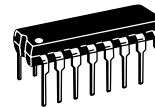

PDIIP-16  
P SUFFIX  
CASE 648

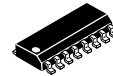

SOIC-16  
D SUFFIX  
CASE 751B

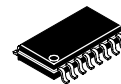
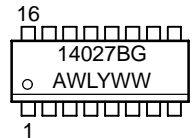

SOEIAJ-16  
F SUFFIX  
CASE 966

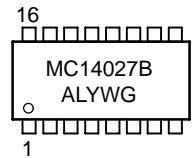

A = Assembly Location  
WL, L = Wafer Lot  
YY, Y = Year  
WW, W = Work Week  
G = Pb-Free Indicator

### ORDERING INFORMATION

See detailed ordering and shipping information in the package dimensions section on page 3 of this data sheet.

# MC14027B

## TRUTH TABLE

Inputs					Outputs*		
C <sup>†</sup>	J	K	S	R	Q <sub>n</sub> <sup>‡</sup>	Q <sub>n+1</sub>	$\overline{Q}_{n+1}$
	1	X	0	0	0	1	0
	X	0	0	0	1	1	0
	0	X	0	0	0	0	1
	X	1	0	0	1	0	1
	1	1	0	0	Q <sub>0</sub>	$\overline{Q_0}$	Q <sub>0</sub>
	X	X	0	0	X	Q <sub>n</sub>	$\overline{Q}_n$
X	X	X	1	0	X	1	0
X	X	X	0	1	X	0	1
X	X	X	1	1	X	1	1

No  
Change

X = Don't Care  
† = Level Change

‡ = Present State  
\* = Next State

## PIN ASSIGNMENT

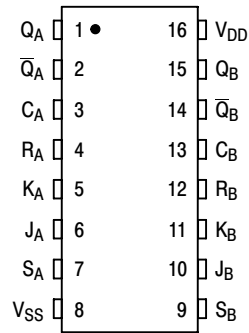

## BLOCK DIAGRAM

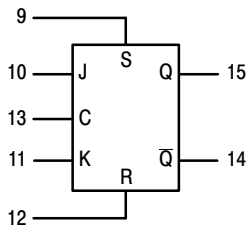
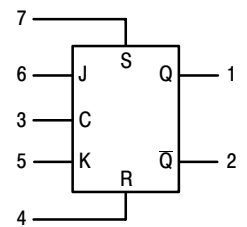

V<sub>DD</sub> = PIN 16  
V<sub>SS</sub> = PIN 8

## MC14027B

### ORDERING INFORMATION

Device	Package	Shipping†
MC14027BCP	PDIP-16	500 Units / Rail
MC14027BCPG	PDIP-16 (Pb-Free)	500 Units / Rail
MC14027BD	SOIC-16	48 Units / Rail
MC14027BDG	SOIC-16 (Pb-Free)	48 Units / Rail
MC14027BDR2	SOIC-16	2500 Units / Tape & Reel
MC14027BDR2G	SOIC-16 (Pb-Free)	2500 Units / Tape & Reel
MC14027BFEL	SOEIAJ-16	2000 Units / Tape & Reel
MC14027BFELG	SOEIAJ-16 (Pb-Free)	2000 Units / Tape & Reel

†For information on tape and reel specifications, including part orientation and tape sizes, please refer to our Tape and Reel Packaging Specifications Brochure, BRD8011/D.

# MC14027B

## ELECTRICAL CHARACTERISTICS (Voltages Referenced to $V_{SS}$ )

Characteristic	Symbol	$V_{DD}$ Vdc	- 55° C		25° C			125° C		Unit
			Min	Max	Min	Typ (Note 2)	Max	Min	Max	
Output Voltage $V_{in} = V_{DD}$ or 0	"0" Level $V_{OL}$	5.0	—	0.05	—	0	0.05	—	0.05	Vdc
		10	—	0.05	—	0	0.05	—	0.05	
$V_{in} = 0$ or $V_{DD}$	"1" Level $V_{OH}$	5.0	4.95	—	4.95	5.0	—	4.95	—	Vdc
		10	9.95	—	9.95	10	—	9.95	—	
Input Voltage ( $V_O = 4.5$ or $0.5$ Vdc) ( $V_O = 9.0$ or $1.0$ Vdc) ( $V_O = 13.5$ or $1.5$ Vdc)	"0" Level $V_{IL}$	5.0	—	1.5	—	2.25	1.5	—	1.5	Vdc
		10	—	3.0	—	4.50	3.0	—	3.0	
( $V_O = 0.5$ or $4.5$ Vdc) ( $V_O = 1.0$ or $9.0$ Vdc) ( $V_O = 1.5$ or $13.5$ Vdc)	"1" Level $V_{IH}$	5.0	3.5	—	3.5	2.75	—	3.5	—	Vdc
		10	7.0	—	7.0	5.50	—	7.0	—	
Output Drive Current ( $V_{OH} = 2.5$ Vdc) ( $V_{OH} = 4.6$ Vdc) ( $V_{OH} = 9.5$ Vdc) ( $V_{OH} = 13.5$ Vdc)	Source $I_{OH}$	5.0	-3.0	—	-2.4	-4.2	—	-1.7	—	mAdc
		5.0	-0.64	—	-0.51	-0.88	—	-0.36	—	
( $V_{OL} = 0.4$ Vdc) ( $V_{OL} = 0.5$ Vdc) ( $V_{OL} = 1.5$ Vdc)	Sink $I_{OL}$	5.0	0.64	—	0.51	0.88	—	0.36	—	mAdc
		10	1.6	—	1.3	2.25	—	0.9	—	
( $V_{OL} = 1.5$ Vdc)		15	4.2	—	3.4	8.8	—	2.4	—	
Input Current	$I_{in}$	15	—	$\pm 0.1$	—	$\pm 0.00001$	$\pm 0.1$	—	$\pm 1.0$	$\mu$ Adc
Input Capacitance ( $V_{in} = 0$ )	$C_{in}$	—	—	—	—	5.0	7.5	—	—	pF
Quiescent Current (Per Package)	$I_{DD}$	5.0	—	1.0	—	0.002	1.0	—	30	$\mu$ Adc
		10	—	2.0	—	0.004	2.0	—	60	
		15	—	4.0	—	0.006	4.0	—	120	
Total Supply Current (Notes 3 & 4) (Dynamic plus Quiescent, Per Package) ( $C_L = 50$ pF on all outputs, all buffers switching)	$I_T$	5.0	$I_T = (0.8 \mu\text{A/kHz}) f + I_{DD}$							$\mu$ Adc
	10	$I_T = (1.6 \mu\text{A/kHz}) f + I_{DD}$								
	15	$I_T = (2.4 \mu\text{A/kHz}) f + I_{DD}$								

2. Data labelled "Typ" is not to be used for design purposes but is intended as an indication of the IC's potential performance.

3. The formulas given are for the typical characteristics only at 25° C.

4. To calculate total supply current at loads other than 50 pF:

$$I_T(C_L) = I_T(50 \text{ pF}) + (C_L - 50) \text{ Vfk}$$

where:  $I_T$  is in  $\mu\text{A}$  (per package),  $C_L$  in pF,  $V = (V_{DD} - V_{SS})$  in volts,  $f$  in kHz is input frequency, and  $k = 0.002$ .

# MC14027B

## SWITCHING CHARACTERISTICS (Note 5) ( $C_L = 50 \text{ pF}$ , $T_A = 25^\circ\text{C}$ )

Characteristic	Symbol	$V_{DD}$	Min	Typ (Note 6)	Max	Unit
Output Rise and Fall Time $t_{TLH}, t_{THL} = (1.5 \text{ ns/pF}) C_L + 25 \text{ ns}$ $t_{TLH}, t_{THL} = (0.75 \text{ ns/pF}) C_L + 12.5 \text{ ns}$ $t_{TLH}, t_{THL} = (0.55 \text{ ns/pF}) C_L + 12.5 \text{ ns}$	$t_{TLH},$ $t_{THL}$	5.0 10 15	— — —	100 50 40	200 100 80	ns
Propagation Delay Times** Clock to Q, Q $t_{PLH}, t_{PHL} = (1.7 \text{ ns/pF}) C_L + 90 \text{ ns}$ $t_{PLH}, t_{PHL} = (0.66 \text{ ns/pF}) C_L + 42 \text{ ns}$ $t_{PLH}, t_{PHL} = (0.5 \text{ ns/pF}) C_L + 25 \text{ ns}$  Set to Q, Q $t_{PLH}, t_{PHL} = (1.7 \text{ ns/pF}) C_L + 90 \text{ ns}$ $t_{PLH}, t_{PHL} = (0.66 \text{ ns/pF}) C_L + 42 \text{ ns}$ $t_{PLH}, t_{PHL} = (0.5 \text{ ns/pF}) C_L + 25 \text{ ns}$  Reset to Q, Q $t_{PLH}, t_{PHL} = (1.7 \text{ ns/pF}) C_L + 265 \text{ ns}$ $t_{PLH}, t_{PHL} = (0.66 \text{ ns/pF}) C_L + 67 \text{ ns}$ $t_{PLH}, t_{PHL} = (0.5 \text{ ns/pF}) C_L + 50 \text{ ns}$	$t_{PLH},$ $t_{PHL}$	5.0 10 15  5.0 10 15  5.0 10 15	— — —  — — —  — — —	175 75 50  175 75 50  350 100 75	350 150 100  350 150 100  450 200 150	ns
Setup Times	$t_{su}$	5.0 10 15	140 50 35	70 25 17	— — —	ns
Hold Times	$t_h$	5.0 10 15	140 50 35	70 25 17	— — —	ns
Clock Pulse Width	$t_{WH}, t_{WL}$	5.0 10 15	330 110 75	165 55 38	— — —	ns
Clock Pulse Frequency	$f_{cl}$	5.0 10 15	— — —	3.0 9.0 13	1.5 4.5 6.5	MHz
Clock Pulse Rise and Fall Time	$t_{TLH}, t_{THL}$	5.0 10 15	— — —	— — —	15 5.0 4.0	$\mu\text{s}$
Removal Times	$t_{rem}$	5 10 15  5 10 15	90 45 35  50 25 20	10 5 3  -30 -15 -10	— — —  — — —	ns
Set and Reset Pulse Width	$t_{WH}$	5.0 10 15	250 100 70	125 50 35	— — —	ns

5. The formulas given are for the typical characteristics only at  $25^\circ\text{C}$ .

6. Data labelled "Typ" is not to be used for design purposes but is intended as an indication of the IC's potential performance.

# MC14027B

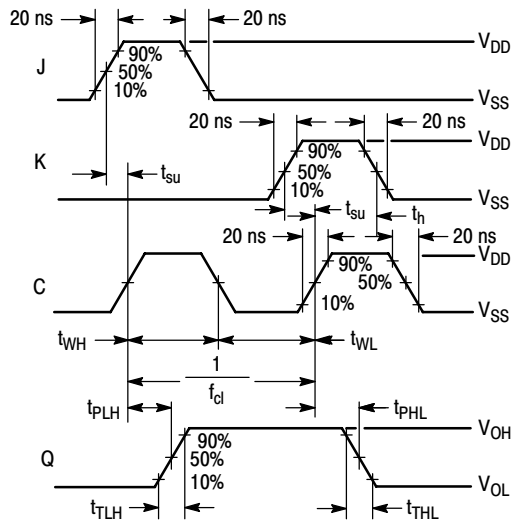

Inputs R and S low.  
 For the measurement of  $t_{WH}$ ,  $1/f_{cl}$ , and  $P_D$   
 the Inputs J and K are kept high.

**Figure 1. Dynamic Signal Waveforms (J, K, Clock, and Output)**

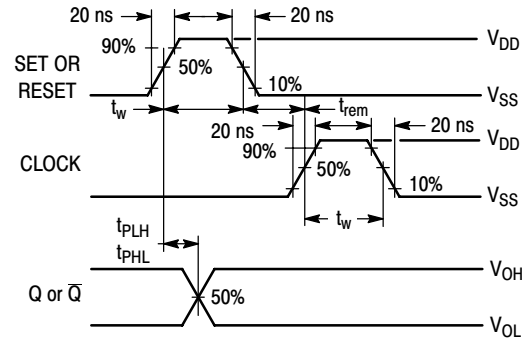

**Figure 2. Dynamic Signal Waveforms (Set, Reset, Clock, and Output)**

## LOGIC DIAGRAM (1/2 of Device Shown)

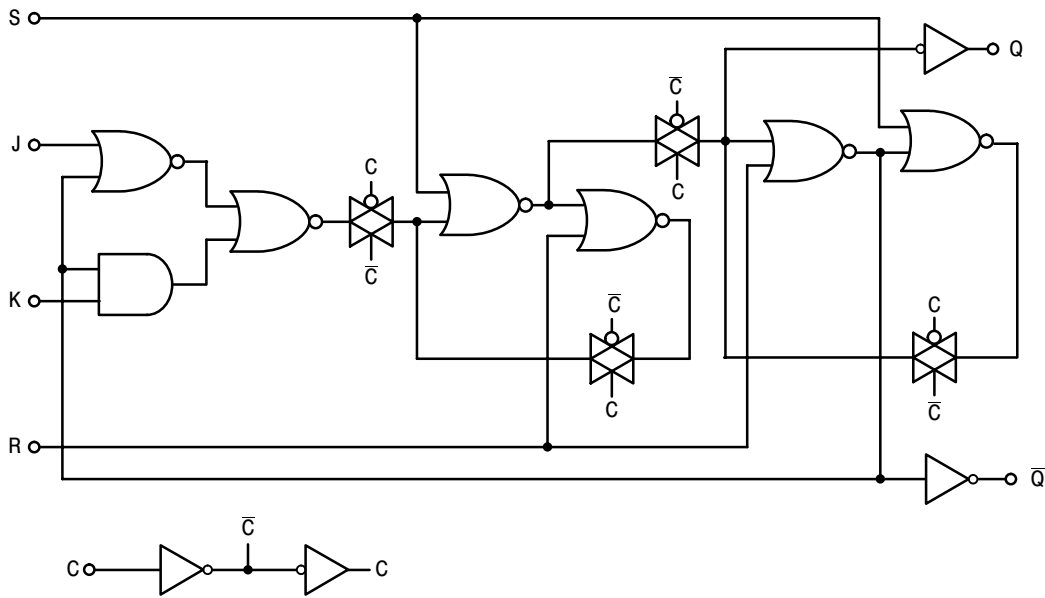

# MC14027B

## PACKAGE DIMENSIONS

PDIP-16  
P SUFFIX  
PLASTIC DIP PACKAGE  
CASE 648-08  
ISSUE T

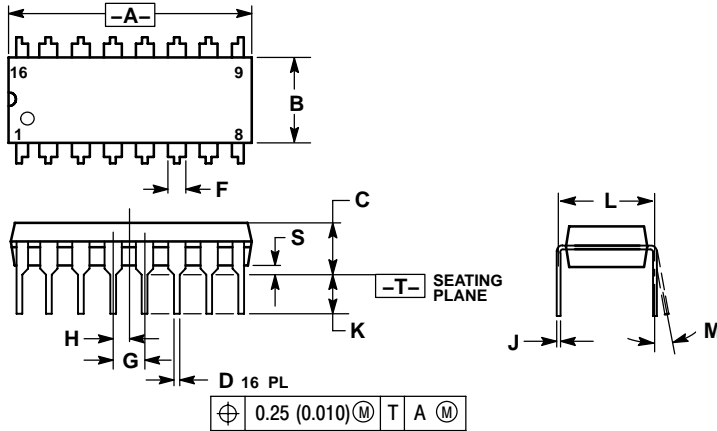

- NOTES:
1. DIMENSIONING AND TOLERANCING PER ANSI Y14.5M, 1982.
  2. CONTROLLING DIMENSION: INCH.
  3. DIMENSION L TO CENTER OF LEADS WHEN FORMED PARALLEL.
  4. DIMENSION B DOES NOT INCLUDE MOLD FLASH.
  5. ROUNDED CORNERS OPTIONAL.

DIM	INCHES		MILLIMETERS	
	MIN	MAX	MIN	MAX
A	0.740	0.770	18.80	19.55
B	0.250	0.270	6.35	6.85
C	0.145	0.175	3.69	4.44
D	0.015	0.021	0.39	0.53
F	0.040	0.70	1.02	1.77
G	0.100 BSC		2.54 BSC	
H	0.050 BSC		1.27 BSC	
J	0.008	0.015	0.21	0.38
K	0.110	0.130	2.80	3.30
L	0.295	0.305	7.50	7.74
M	0°	10°	0°	10°
S	0.020	0.040	0.51	1.01

SOIC-16  
D SUFFIX  
PLASTIC SOIC PACKAGE  
CASE 751B-05  
ISSUE J

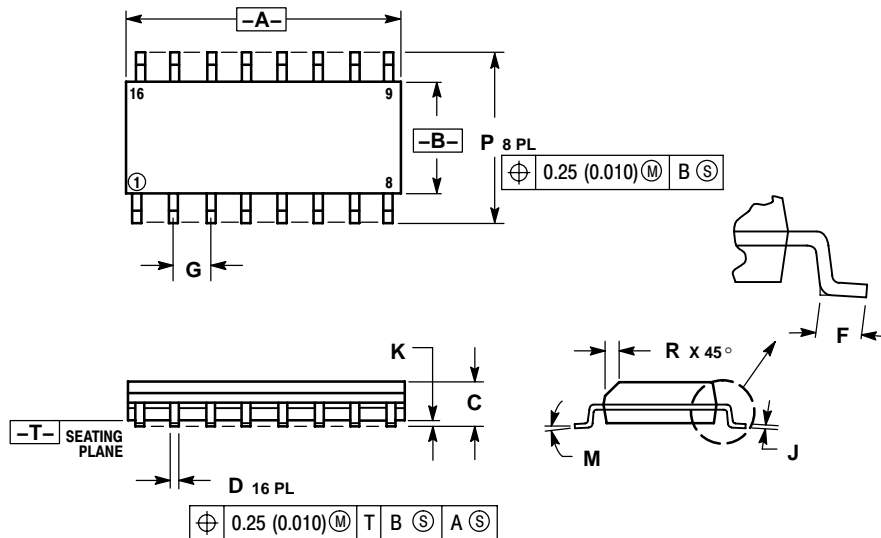

- NOTES:
1. DIMENSIONING AND TOLERANCING PER ANSI Y14.5M, 1982.
  2. CONTROLLING DIMENSION: MILLIMETER.
  3. DIMENSIONS A AND B DO NOT INCLUDE MOLD PROTRUSION.
  4. MAXIMUM MOLD PROTRUSION 0.15 (0.006) PER SIDE.
  5. DIMENSION D DOES NOT INCLUDE DAMBAR PROTRUSION. ALLOWABLE DAMBAR PROTRUSION SHALL BE 0.127 (0.005) TOTAL IN EXCESS OF THE D DIMENSION AT MAXIMUM MATERIAL CONDITION.

DIM	MILLIMETERS		INCHES	
	MIN	MAX	MIN	MAX
A	9.80	10.00	0.386	0.393
B	3.80	4.00	0.150	0.157
C	1.35	1.75	0.054	0.068
D	0.35	0.49	0.014	0.019
F	0.40	1.25	0.016	0.049
G	1.27 BSC		0.050 BSC	
J	0.19	0.25	0.008	0.009
K	0.10	0.25	0.004	0.009
M	0°	7°	0°	7°
P	5.80	6.20	0.229	0.244
R	0.25	0.50	0.010	0.019

# MC14027B

## PACKAGE DIMENSIONS

### SOEIAJ-16 F SUFFIX PLASTIC EIAJ SOIC PACKAGE CASE 966-01 ISSUE 0

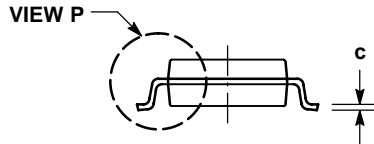
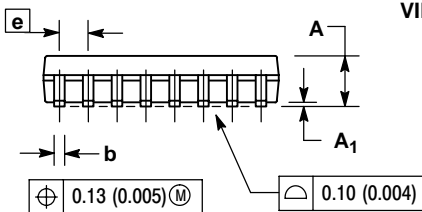
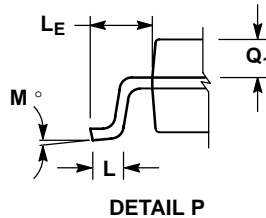
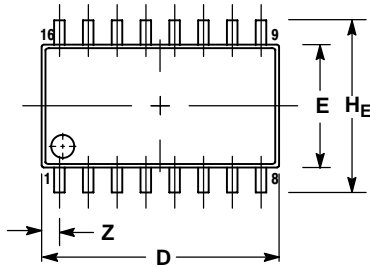

#### NOTES:

1. DIMENSIONING AND TOLERANCING PER ANSI Y14.5M, 1982.
2. CONTROLLING DIMENSION: MILLIMETER.
3. DIMENSIONS D AND E DO NOT INCLUDE MOLD FLASH OR PROTRUSIONS AND ARE MEASURED AT THE PARTING LINE. MOLD FLASH OR PROTRUSIONS SHALL NOT EXCEED 0.15 (0.006) PER SIDE.
4. TERMINAL NUMBERS ARE SHOWN FOR REFERENCE ONLY.
5. THE LEAD WIDTH DIMENSION (b) DOES NOT INCLUDE DAMBAR PROTRUSION. ALLOWABLE DAMBAR PROTRUSION SHALL BE 0.08 (0.003) TOTAL IN EXCESS OF THE LEAD WIDTH DIMENSION AT MAXIMUM MATERIAL CONDITION. DAMBAR CANNOT BE LOCATED ON THE LOWER RADIUS OR THE FOOT. MINIMUM SPACE BETWEEN PROTRUSIONS AND ADJACENT LEAD TO BE 0.46 (0.018).

DIM	MILLIMETERS		INCHES	
	MIN	MAX	MIN	MAX
A	---	2.05	---	0.081
A <sub>1</sub>	0.05	0.20	0.002	0.008
b	0.35	0.50	0.014	0.020
c	0.18	0.27	0.007	0.011
D	9.90	10.50	0.390	0.413
E	5.10	5.45	0.201	0.215
e	1.27 BSC		0.050 BSC	
HE	7.40	8.20	0.291	0.323
L	0.50	0.85	0.020	0.033
LE	1.10	1.50	0.043	0.059
M	0°	10°	0°	10°
Q <sub>1</sub>	0.70	0.90	0.028	0.035
Z	---	0.78	---	0.031

**ON Semiconductor** and **ON** are registered trademarks of Semiconductor Components Industries, LLC (SCILLC). SCILLC reserves the right to make changes without further notice to any products herein. SCILLC makes no warranty, representation or guarantee regarding the suitability of its products for any particular purpose, nor does SCILLC assume any liability arising out of the application or use of any product or circuit, and specifically disclaims any and all liability, including without limitation special, consequential or incidental damages. "Typical" parameters which may be provided in SCILLC data sheets and/or specifications can and do vary in different applications and actual performance may vary over time. All operating parameters, including "Typicals" must be validated for each customer application by customer's technical experts. SCILLC does not convey any license under its patent rights nor the rights of others. SCILLC products are not designed, intended, or authorized for use as components in systems intended for surgical implant into the body, or other applications intended to support or sustain life, or for any other application in which the failure of the SCILLC product could create a situation where personal injury or death may occur. Should Buyer purchase or use SCILLC products for any such unintended or unauthorized application, Buyer shall indemnify and hold SCILLC and its officers, employees, subsidiaries, affiliates, and distributors harmless against all claims, costs, damages, and expenses, and reasonable attorney fees arising out of, directly or indirectly, any claim of personal injury or death associated with such unintended or unauthorized use, even if such claim alleges that SCILLC was negligent regarding the design or manufacture of the part. SCILLC is an Equal Opportunity/Affirmative Action Employer. This literature is subject to all applicable copyright laws and is not for resale in any manner.

#### PUBLICATION ORDERING INFORMATION

**LITERATURE FULFILLMENT:**  
Literature Distribution Center for ON Semiconductor  
P.O. Box 61312, Phoenix, Arizona 85082-1312 USA  
**Phone:** 480-829-7710 or 800-344-3860 Toll Free USA/Canada  
**Fax:** 480-829-7709 or 800-344-3867 Toll Free USA/Canada  
**Email:** orderlit@onsemi.com

**N. American Technical Support:** 800-282-9855 Toll Free  
USA/Canada

**Japan:** ON Semiconductor, Japan Customer Focus Center  
2-9-1 Kamimeguro, Meguro-ku, Tokyo, Japan 153-0051  
**Phone:** 81-3-5773-3850

**ON Semiconductor Website:** <http://onsemi.com>

**Order Literature:** <http://www.onsemi.com/litorder>

For additional information, please contact your local Sales Representative.

MC14027B/D