

# ON Semiconductor

## Is Now

# onsemi™

To learn more about onsemi™, please visit our website at  
[www.onsemi.com](http://www.onsemi.com)

**onsemi** and **onsemi** and other names, marks, and brands are registered and/or common law trademarks of Semiconductor Components Industries, LLC dba "**onsemi**" or its affiliates and/or subsidiaries in the United States and/or other countries. **onsemi** owns the rights to a number of patents, trademarks, copyrights, trade secrets, and other intellectual property. A listing of **onsemi** product/patent coverage may be accessed at [www.onsemi.com/site/pdf/Patent-Marking.pdf](http://www.onsemi.com/site/pdf/Patent-Marking.pdf). **onsemi** reserves the right to make changes at any time to any products or information herein, without notice. The information herein is provided "as-is" and **onsemi** makes no warranty, representation or guarantee regarding the accuracy of the information, product features, availability, functionality, or suitability of its products for any particular purpose, nor does **onsemi** assume any liability arising out of the application or use of any product or circuit, and specifically disclaims any and all liability, including without limitation special, consequential or incidental damages. Buyer is responsible for its products and applications using **onsemi** products, including compliance with all laws, regulations and safety requirements or standards, regardless of any support or applications information provided by **onsemi**. "Typical" parameters which may be provided in **onsemi** data sheets and/or specifications can and do vary in different applications and actual performance may vary over time. All operating parameters, including "Typicals" must be validated for each customer application by customer's technical experts. **onsemi** does not convey any license under any of its intellectual property rights nor the rights of others. **onsemi** products are not designed, intended, or authorized for use as a critical component in life support systems or any FDA Class 3 medical devices or medical devices with a same or similar classification in a foreign jurisdiction or any devices intended for implantation in the human body. Should Buyer purchase or use **onsemi** products for any such unintended or unauthorized application, Buyer shall indemnify and hold **onsemi** and its officers, employees, subsidiaries, affiliates, and distributors harmless against all claims, costs, damages, and expenses, and reasonable attorney fees arising out of, directly or indirectly, any claim of personal injury or death associated with such unintended or unauthorized use, even if such claim alleges that **onsemi** was negligent regarding the design or manufacture of the part. **onsemi** is an Equal Opportunity/Affirmative Action Employer. This literature is subject to all applicable copyright laws and is not for resale in any manner. Other names and brands may be claimed as the property of others.

# TinyLogic ULP-A Dual Buffer

## NC7WV16

The NC7WV16 is a dual buffer in tiny footprint packages. The device is designed to operate for  $V_{CC} = 0.9\text{ V}$  to  $3.6\text{ V}$ .

### Features

- Designed for 0.9 V to 3.6 V  $V_{CC}$  Operation
- 1.6 ns  $t_{PD}$  at 3.3 V (Typ)
- Inputs/Outputs Over-Voltage Tolerant up to 3.6 V
- $I_{OFF}$  Supports Partial Power Down Protection
- Source/Sink 24 mA at 3.3 V
- Available in SC-88 and MicroPak™ Packages
- These Devices are Pb-Free, Halogen Free/BFR Free and are RoHS Compliant

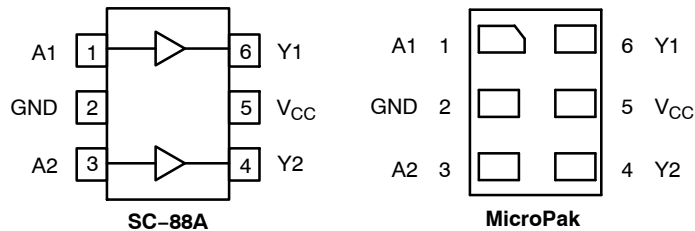

Figure 1. Pinout Diagrams (Top Views)

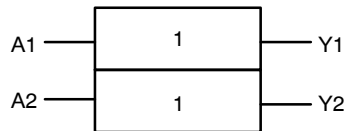

Figure 2. Logic Symbol

### PIN ASSIGNMENT

| Pin | Function |
|-----|----------|
| 1   | A1       |
| 2   | GND      |
| 3   | A2       |
| 4   | Y2       |
| 5   | $V_{CC}$ |
| 6   | Y1       |



ON Semiconductor®

[www.onsemi.com](http://www.onsemi.com)

### MARKING DIAGRAMS



SIP6 1.45X1.0  
MicroPak  
CASE 127EB

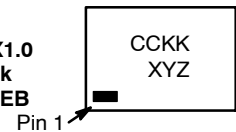

- CC = Specific Device Code
- KK = 2-Digit Lot Run Traceability Code
- XY = 2-Digit Date Code
- Z = Assembly Plant Code

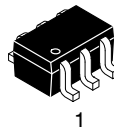

SC-88  
CASE 419B-02

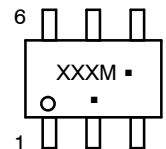

- XXX = Specific Device Code
- M = Date Code\*
- = Pb-Free Package

(Note: Microdot may be in either location)

\*Date Code orientation and/or position may vary depending upon manufacturing location.

### ORDERING INFORMATION

See detailed ordering, marking and shipping information on page 6 of this data sheet.

### FUNCTION TABLE

| A Input | Y Output |
|---------|----------|
| L       | L        |
| H       | H        |

# NC7WV16

## MAXIMUM RATINGS

| Symbol                | Characteristics  | Value  | Unit          |
|-----------------------|--|--|---------------|
| $V_{CC}$              | DC Supply Voltage  | -0.5 to +4.3   | V             |
| $V_{IN}$              | DC Input Voltage   | -0.5 to +4.3   | V             |
| $V_{OUT}$             | DC Output Voltage<br>Active-Mode (High or Low State)<br>Tri-State Mode (Note 1)<br>Power-Down Mode ( $V_{CC} = 0$ V) | -0.5 to $V_{CC} + 0.5$<br>-0.5 to +4.3<br>-0.5 to +4.3   | V             |
| $I_{IK}$              | DC Input Diode Current<br>$V_{IN} < GND$   | -50  | mA            |
| $I_{OK}$              | DC Output Diode Current<br>$V_{OUT} < GND$   | -50  | mA            |
| $I_{OUT}$             | DC Output Source/Sink Current  | $\pm 50$   | mA            |
| $I_{CC}$ or $I_{GND}$ | DC Supply Current per Supply Pin or Ground Pin   | $\pm 50$   | mA            |
| $T_{STG}$             | Storage Temperature Range  | -65 to +150  | $^{\circ}C$   |
| $T_L$                 | Lead Temperature, 1 mm from Case for 10 Seconds  | 260  | $^{\circ}C$   |
| $T_J$                 | Junction Temperature Under Bias  | +150   | $^{\circ}C$   |
| $\theta_{JA}$         | Thermal Resistance (Note 2)  | SC-88<br>MicroPak<br>377<br>154                          | $^{\circ}C/W$ |
| $P_D$                 | Power Dissipation in Still Air   | SC-88<br>MicroPak<br>332<br>812                          | mW            |
| MSL                   | Moisture Sensitivity   | Level 1  | -             |
| $F_R$                 | Flammability Rating  | Oxygen Index: 28 to 34<br>UL 94 V-0 @ 0.125 in           | -             |
| $V_{ESD}$             | ESD Withstand Voltage (Note 3)   | Human Body Model<br>Charged Device Model<br>2000<br>1000 | V             |
| $I_{Latchup}$         | Latchup Performance (Note 4)   | $\pm 100$  | mA            |

Stresses exceeding those listed in the Maximum Ratings table may damage the device. If any of these limits are exceeded, device functionality should not be assumed, damage may occur and reliability may be affected.

1. Applicable to devices with outputs that may be tri-stated.
2. Measured with minimum pad spacing on an FR4 board, using 10 mm-by-1 inch, 2 ounce copper trace no air flow per JESD51-7.
3. HBM tested to EIA / JESD22-A114-A. CDM tested to JESD22-C101-A. JEDEC recommends that ESD qualification to EIA/JESD22-A115A (Machine Model) be discontinued.
4. Tested to EIA/JESD78 Class II.

# NC7WV16

## RECOMMENDED OPERATING CONDITIONS

| Symbol     | Parameter  | Min | Max      | Unit |
|------------|--|-----|----------|------|
| $V_{CC}$   | Positive DC Supply Voltage   | 0.9 | 3.6      | V    |
| $V_{IN}$   | DC Input Voltage   | 0   | 3.6      | V    |
| $V_{OUT}$  | DC Output Voltage<br>Active-Mode (High or Low State)<br>Tri-State Mode (Note 5)<br>Power-Down Mode ( $V_{CC} = 0$ V) | 0   | $V_{CC}$ |      |
|            |  | 0   | 3.6      |      |
|            |  | 0   | 3.6      |      |
| $T_A$      | Operating Temperature Range  | -40 | +85      | °C   |
| $t_r, t_f$ | Input Transition Rise and Fall Time<br>$V_{CC} = 3.3$ V $\pm$ 0.3 V  | 0   | 10       | ns/V |

Functional operation above the stresses listed in the Recommended Operating Ranges is not implied. Extended exposure to stresses beyond the Recommended Operating Ranges limits may affect device reliability.

5. Applicable to devices with outputs that may be tri-stated.

## DC ELECTRICAL CHARACTERISTICS

| Symbol            | Parameter                 | Condition                     | $V_{CC}$ (V) | $T_A = 25^\circ\text{C}$ |                |                      | $T_A = -40^\circ\text{C to } +85^\circ\text{C}$ |                      | Unit |   |
|-------------------|---------------------------|-------------------------------|--------------|--------------------------|----------------|----------------------|---|----------------------|------|---|
|                   |                           |                               |              | Min                      | Typ            | Max                  | Min   | Max                  |      |   |
| $V_{IH}$          | High-Level Input Voltage  |                               | 0.9          | -                        | 0.5            | -                    | -   | -                    | V    |   |
|                   |                           |                               | 1.1 to 1.3   | $0.65 \times V_{CC}$     | -              | -                    | $0.65 \times V_{CC}$                            | -                    |      |   |
|                   |                           |                               | 1.4 to 1.6   | $0.65 \times V_{CC}$     | -              | -                    | $0.65 \times V_{CC}$                            | -                    |      |   |
|                   |                           |                               | 1.65 to 1.95 | $0.65 \times V_{CC}$     | -              | -                    | $0.65 \times V_{CC}$                            | -                    |      |   |
|                   |                           |                               | 2.3 to <2.7  | 1.6                      | -              | -                    | 1.6   | -                    |      |   |
|                   |                           |                               | 2.7 to 3.6   | 2.0                      | -              | -                    | 2.0   | -                    |      |   |
| $V_{IL}$          | Low-Level Input Voltage   |                               | 0.9          | -                        | 0.5            | -                    | -   | -                    | V    |   |
|                   |                           |                               | 1.1 to 1.3   | -                        | -              | $0.35 \times V_{CC}$ | -   | $0.35 \times V_{CC}$ |      |   |
|                   |                           |                               | 1.4 to 1.6   | -                        | -              | $0.35 \times V_{CC}$ | -   | $0.35 \times V_{CC}$ |      |   |
|                   |                           |                               | 1.65 to 1.95 | -                        | -              | $0.35 \times V_{CC}$ | -   | $0.35 \times V_{CC}$ |      |   |
|                   |                           |                               | 2.3 to <2.7  | -                        | -              | 0.7                  | -   | 0.7                  |      |   |
|                   |                           |                               | 2.7 to 3.6   | -                        | -              | 0.8                  | -   | 0.8                  |      |   |
| $V_{OH}$          | High-Level Output Voltage | $V_{IN} = V_{IH}$ or $V_{IL}$ |              |                          |                |                      |   |                      | V    |   |
|                   |                           | $I_{OH} = -100 \mu\text{A}$   | 0.9          | -                        | $V_{CC} - 0.1$ | -                    | -   | $V_{CC} - 0.1$       |      | - |
|                   |                           |                               | 1.1 to 1.3   | $V_{CC} - 0.1$           | -              | -                    | $V_{CC} - 0.1$                                  | -                    |      |   |
|                   |                           |                               | 1.4 to 1.6   | $V_{CC} - 0.1$           | -              | -                    | $V_{CC} - 0.1$                                  | -                    |      |   |
|                   |                           |                               | 1.65 to 1.95 | $V_{CC} - 0.2$           | -              | -                    | $V_{CC} - 0.2$                                  | -                    |      |   |
|                   |                           |                               | 2.3 to <2.7  | $V_{CC} - 0.2$           | -              | -                    | $V_{CC} - 0.2$                                  | -                    |      |   |
|                   |                           |                               | 2.7 to 3.6   | $V_{CC} - 0.2$           | -              | -                    | $V_{CC} - 0.2$                                  | -                    |      |   |
|                   |                           | $I_{OH} = -2$ mA              | 1.1 to 1.3   | $0.75 \times V_{CC}$     | -              | -                    | $0.75 \times V_{CC}$                            | -                    |      |   |
|                   |                           |                               | 1.4 to 1.6   | $0.75 \times V_{CC}$     | -              | -                    | $0.75 \times V_{CC}$                            | -                    |      |   |
|                   |                           | $I_{OH} = -4$ mA              | 1.65 to 1.95 | 1.25                     | -              | -                    | 1.25  | -                    |      |   |
|                   |                           |                               | 2.3 to <2.7  | 2.0                      | -              | -                    | 2.0   | -                    |      |   |
|                   |                           | $I_{OH} = -6$ mA              | 2.3 to <2.7  | 1.8                      | -              | -                    | 1.8   | -                    |      |   |
|                   |                           |                               | 2.7 to 3.6   | 2.2                      | -              | -                    | 2.2   | -                    |      |   |
|                   |                           | $I_{OH} = -12$ mA             | 2.3 to <2.7  | 1.7                      | -              | -                    | 1.7   | -                    |      |   |
|                   |                           |                               | 2.7 to 3.6   | 2.4                      | -              | -                    | 2.4   | -                    |      |   |
| $I_{OH} = -18$ mA | 2.3 to <2.7               | 1.7                           | -            | -                        | 1.7            | -                    |   |                      |      |   |
|                   | 2.7 to 3.6                | 2.4                           | -            | -                        | 2.4            | -                    |   |                      |      |   |
| $I_{OH} = -24$ mA | 2.7 to 3.6                | 2.2                           | -            | -                        | 2.2            | -                    |   |                      |      |   |

# NC7WV16

## DC ELECTRICAL CHARACTERISTICS (continued)

| Symbol                  | Parameter                 | Condition   | V <sub>CC</sub> (V)            | T <sub>A</sub> = 25°C |      |                        | T <sub>A</sub> = -40°C to +85°C |                        | Unit |                        |
|-------------------------|---------------------------|---|--------------------------------|-----------------------|------|------------------------|---------------------------------|------------------------|------|------------------------|
|                         |                           |   |                                | Min                   | Typ  | Max                    | Min                             | Max                    |      |                        |
| V <sub>OL</sub>         | Low-Level Output Voltage  | V <sub>IN</sub> = V <sub>IH</sub> or V <sub>IL</sub>              |                                |                       |      |                        |                                 |                        | V    |                        |
|                         |                           | I <sub>OL</sub> = 100 μA  | 0.9                            | -                     | 0.1  | -                      | -                               | -                      |      | -                      |
|                         |                           |   | 1.1 to 1.3                     | -                     | -    | 0.1                    | -                               | 0.1                    |      | -                      |
|                         |                           |   | 1.4 to 1.6                     | -                     | -    | 0.1                    | -                               | 0.1                    |      | -                      |
|                         |                           |   | 1.65 to 1.95                   | -                     | -    | 0.2                    | -                               | 0.2                    |      | -                      |
|                         |                           |   | 2.3 to < 2.7                   | -                     | -    | 0.2                    | -                               | 0.2                    |      | -                      |
|                         |                           |   | 2.7 to 3.6                     | -                     | -    | 0.2                    | -                               | 0.2                    |      | -                      |
|                         |                           | I <sub>OL</sub> = 2 mA  | 1.1 to 1.3                     | -                     | -    | 0.25 x V <sub>CC</sub> | -                               | 0.25 x V <sub>CC</sub> |      | -                      |
|                         |                           |   | I <sub>OL</sub> = 4 mA         | 1.4 to 1.6            | -    | -                      | 0.25 x V <sub>CC</sub>          | -                      |      | 0.25 x V <sub>CC</sub> |
|                         |                           | I <sub>OL</sub> = 6 mA  | 1.65 to 1.95                   | -                     | -    | 0.3                    | -                               | 0.3                    |      | -                      |
|                         |                           |   | I <sub>OL</sub> = 12 mA        | 2.3 to < 2.7          | -    | -                      | 0.4                             | -                      |      | 0.4                    |
|                         |                           | I <sub>OL</sub> = 18 mA   |                                | 2.7 to 3.6            | -    | -                      | 0.4                             | -                      |      | 0.4                    |
| I <sub>OL</sub> = 24 mA | 2.3 to < 2.7              |   | -                              | -                     | 0.6  | -                      | 0.6                             | -                      |      |                        |
|                         | I <sub>OL</sub> = 24 mA   | 2.7 to 3.6  | -                              | -                     | 0.4  | -                      | 0.4                             | -                      |      |                        |
| I <sub>OL</sub> = 24 mA |                           | 2.7 to 3.6  | -                              | -                     | 0.55 | -                      | 0.55                            | -                      |      |                        |
|                         | I <sub>IN</sub>           | Input Leakage Current   | V <sub>IN</sub> = 0 V to 3.6 V | 0.9 to 3.6            | -    | -                      | ±0.1                            | -                      | ±0.5 | μA                     |
| I <sub>OFF</sub>        | Power Off Leakage Current | V <sub>IN</sub> = 0 V to 3.6 V or V <sub>OUT</sub> = 0 V to 3.6 V | 0                              | -                     | -    | 0.5                    | -                               | 0.5                    | μA   |                        |
| I <sub>CC</sub>         | Quiescent Supply Current  | V <sub>IN</sub> = V <sub>CC</sub> or GND                          | 0.9 to 3.6                     | -                     | -    | 0.9                    | -                               | 0.9                    | μA   |                        |

Product parametric performance is indicated in the Electrical Characteristics for the listed test conditions, unless otherwise noted. Product performance may not be indicated by the Electrical Characteristics if operated under different conditions.

## AC ELECTRICAL CHARACTERISTICS

| Symbol                                 | Parameter                                   | Condition                                      | V <sub>CC</sub> (V) | T <sub>A</sub> = 25°C |      |      | T <sub>A</sub> = -40°C to +85°C |      | Unit |
|--|---|--|---------------------|-----------------------|------|------|---------------------------------|------|------|
|  |   |  |                     | Min                   | Typ  | Max  | Min                             | Max  |      |
| t <sub>PLH</sub> ,<br>t <sub>PHL</sub> | Propagation Delay, A to Y (Figures 3 and 4) | R <sub>L</sub> = 1 MΩ, C <sub>L</sub> = 15 pF  | 0.9                 | -                     | 12.8 | -    | -                               | -    | ns   |
|  |   | R <sub>L</sub> = 2 kΩ, C <sub>L</sub> = 15 pF  | 1.1 to 1.3          | -                     | 4.1  | 13.5 | -                               | 17.9 |      |
|  |   |  | 1.4 to 1.6          | -                     | 2.7  | 6.5  | -                               | 7.0  |      |
|  |   |  | 1.65 to 1.95        | -                     | 2.5  | 5.2  | -                               | 6.2  |      |
|  |   | R <sub>L</sub> = 500 Ω, C <sub>L</sub> = 30 pF | 2.3 to 2.7          | -                     | 1.9  | 3.7  | -                               | 4.4  |      |
|  |   |  | 2.7 to 3.6          | -                     | 1.6  | 3.3  | -                               | 3.8  |      |

## CAPACITIVE CHARACTERISTICS

| Symbol           | Parameter                              | Test Condition   | Typical (T <sub>A</sub> = 25°C) | Unit |
|------------------|--|--|---------------------------------|------|
| C <sub>IN</sub>  | Input Capacitance                      | V <sub>CC</sub> = 0 V  | 2.0                             | pF   |
| C <sub>OUT</sub> | Output Capacitance                     | V <sub>CC</sub> = 0 V  | 4.5                             | pF   |
| C <sub>PD</sub>  | Power Dissipation Capacitance (Note 6) | f = 10 MHz, V <sub>CC</sub> = 0.9 to 3.6 V, V <sub>IN</sub> = 0 V or V <sub>CC</sub> | 10.0                            | pF   |

6. C<sub>PD</sub> is defined as the value of the internal equivalent capacitance which is calculated from the operating current consumption without load. Average operating current can be obtained by the equation I<sub>CC(OPR)</sub> = C<sub>PD</sub> • V<sub>CC</sub> • f<sub>in</sub> + I<sub>CC</sub>. C<sub>PD</sub> is used to determine the no-load dynamic power consumption: P<sub>D</sub> = C<sub>PD</sub> • V<sub>CC</sub><sup>2</sup> • f<sub>in</sub> + I<sub>CC</sub> • V<sub>CC</sub>.

# NC7WV16

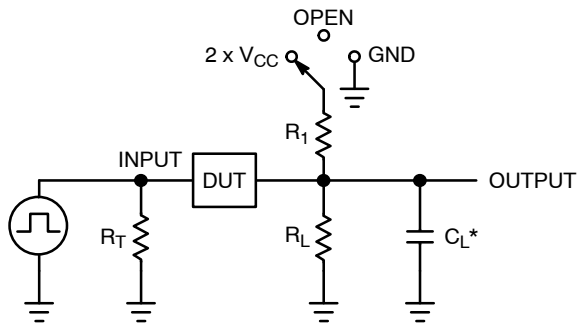

$C_L$  includes probe and jig capacitance  
 $R_T$  is  $Z_{OUT}$  of pulse generator (typically 50  $\Omega$ )  
 $f = 1$  MHz

| Test                | Switch Position   |
|---------------------|-------------------|
| $t_{PLH} / t_{PHL}$ | Open              |
| $t_{PLZ} / t_{PZL}$ | $2 \times V_{CC}$ |
| $t_{PHZ} / t_{PZH}$ | GND               |

Figure 3. Test Circuit



| $V_{CC}, V$  | $V_{mi}, V$  | $V_{mo}, V$  | $V_Y, V$ |
|--------------|--------------|--------------|----------|
| 0.9          | $V_{CC} / 2$ | $V_{CC} / 2$ | 0.1      |
| 1.1 to 1.3   | $V_{CC} / 2$ | $V_{CC} / 2$ | 0.1      |
| 1.4 to 1.6   | $V_{CC} / 2$ | $V_{CC} / 2$ | 0.1      |
| 1.65 to 1.95 | $V_{CC} / 2$ | $V_{CC} / 2$ | 0.15     |
| 2.3 to 2.7   | $V_{CC} / 2$ | $V_{CC} / 2$ | 0.15     |
| 3.0 to 3.6   | 1.5          | 1.5          | 0.3      |

Figure 4. Switching Waveforms

# NC7WV16

## ORDERING INFORMATION

| Device     | Package  | Marking | Pin 1 Orientation<br>(See below) | Shipping†          |
|------------|----------|---------|----------------------------------|--------------------|
| NC7WV16P6X | SC-88    | V16     | Q4                               | 3000 / Tape & Reel |
| NC7WV16L6X | MicroPak | AY      | Q4                               | 5000 / Tape & Reel |

†For information on tape and reel specifications, including part orientation and tape sizes, please refer to our Tape and Reel Packaging Specifications Brochure, BRD8011/D.

### Pin 1 Orientation in Tape and Reel

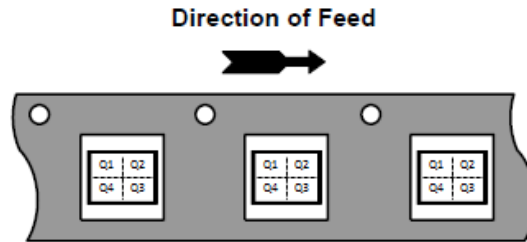

MicroPak is trademark of Semiconductor Components Industries, LLC (SCILLC) or its subsidiaries in the United States and/or other countries.

# NC7WV16

## PACKAGE DIMENSIONS

SIP6 1.45X1.0  
CASE 127EB  
ISSUE O

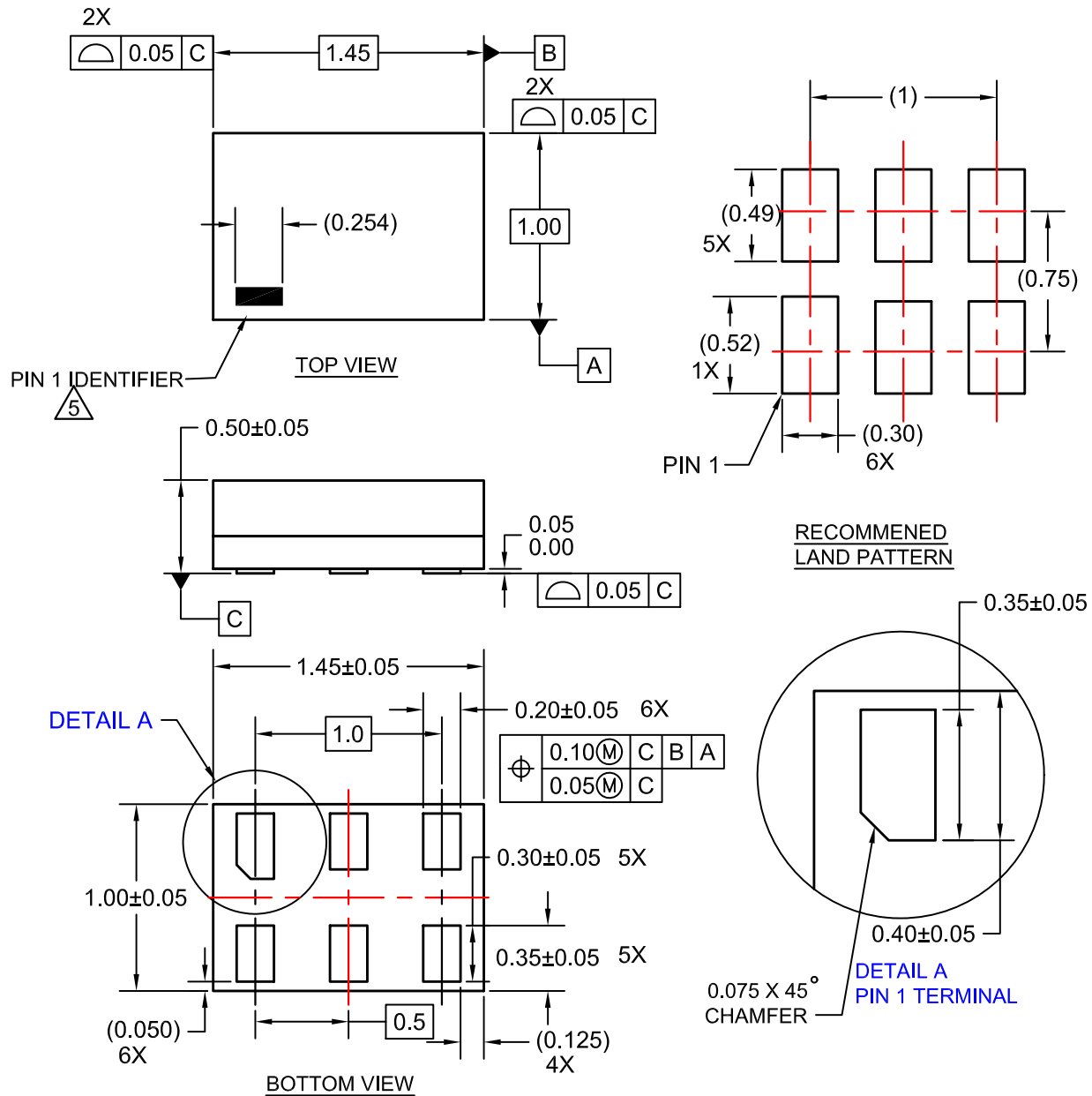

**NOTES:**

1. CONFORMS TO JEDEC STANDARD MO-252 VARIATION UAAD
2. DIMENSIONS ARE IN MILLIMETERS
3. DRAWING CONFORMS TO ASME Y14.5M-2009
4. PIN ONE IDENTIFIER IS 2X LENGTH OF ANY OTHER LINE IN THE MARK CODE LAYOUT.



# NC7WV16

## PACKAGE DIMENSIONS

SC-88/SC70-6/SOT-363  
CASE 419B-02  
ISSUE Y



### NOTES:

1. DIMENSIONING AND TOLERANCING PER ASME Y14.5M, 1994.
2. CONTROLLING DIMENSION: MILLIMETERS.
3. DIMENSIONS D AND E1 DO NOT INCLUDE MOLD FLASH, PROTRUSIONS, OR GATE BURRS. MOLD FLASH, PROTRUSIONS, OR GATE BURRS SHALL NOT EXCEED 0.20 PER END.
4. DIMENSIONS D AND E1 AT THE OUTERMOST EXTREMES OF THE PLASTIC BODY AND DATUM H.
5. DATUMS A AND B ARE DETERMINED AT DATUM H.
6. DIMENSIONS b AND c APPLY TO THE FLAT SECTION OF THE LEAD BETWEEN 0.08 AND 0.15 FROM THE TIP.
7. DIMENSION b DOES NOT INCLUDE DAMBAR PROTRUSION. ALLOWABLE DAMBAR PROTRUSION SHALL BE 0.08 TOTAL IN EXCESS OF DIMENSION b AT MAXIMUM MATERIAL CONDITION. THE DAMBAR CANNOT BE LOCATED ON THE LOWER RADIUS OF THE FOOT.

| DIM | MILLIMETERS |      |      | INCHES    |       |       |
|-----|-------------|------|------|-----------|-------|-------|
|     | MIN         | NOM  | MAX  | MIN       | NOM   | MAX   |
| A   | ---         | ---  | 1.10 | ---       | ---   | 0.043 |
| A1  | 0.00        | ---  | 0.10 | 0.000     | ---   | 0.004 |
| A2  | 0.70        | 0.90 | 1.00 | 0.027     | 0.035 | 0.039 |
| b   | 0.15        | 0.20 | 0.25 | 0.006     | 0.008 | 0.010 |
| C   | 0.08        | 0.15 | 0.22 | 0.003     | 0.006 | 0.009 |
| D   | 1.80        | 2.00 | 2.20 | 0.070     | 0.078 | 0.086 |
| E   | 2.00        | 2.10 | 2.20 | 0.078     | 0.082 | 0.086 |
| E1  | 1.15        | 1.25 | 1.35 | 0.045     | 0.049 | 0.053 |
| e   | 0.65 BSC    |      |      | 0.026 BSC |       |       |
| L   | 0.26        | 0.36 | 0.46 | 0.010     | 0.014 | 0.018 |
| L2  | 0.15 BSC    |      |      | 0.006 BSC |       |       |
| aaa | 0.15        |      |      | 0.006     |       |       |
| bbb | 0.30        |      |      | 0.012     |       |       |
| ccc | 0.10        |      |      | 0.004     |       |       |
| ddd | 0.10        |      |      | 0.004     |       |       |

### RECOMMENDED SOLDERING FOOTPRINT\*

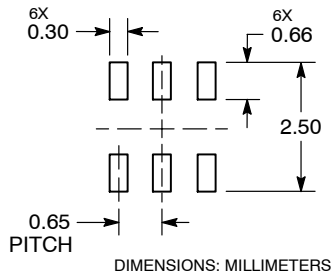

\*For additional information on our Pb-Free strategy and soldering details, please download the ON Semiconductor Soldering and Mounting Techniques Reference Manual, SOLDERRM/D.

STYLES ON PAGE 2

# NC7WV16

SC-88/SC70-6/SOT-363

CASE 419B-02

ISSUE Y

|  |  |   |   |   |   |
|--|--|---|---|---|---|
| STYLE 1:<br>PIN 1. EMITTER 2<br>2. BASE 2<br>3. COLLECTOR 1<br>4. EMITTER 1<br>5. BASE 1<br>6. COLLECTOR 2 | STYLE 2:<br>CANCELLED  | STYLE 3:<br>CANCELLED   | STYLE 4:<br>PIN 1. CATHODE<br>2. CATHODE<br>3. COLLECTOR<br>4. EMITTER<br>5. BASE<br>6. ANODE               | STYLE 5:<br>PIN 1. ANODE<br>2. ANODE<br>3. COLLECTOR<br>4. EMITTER<br>5. BASE<br>6. CATHODE                 | STYLE 6:<br>PIN 1. ANODE 2<br>2. N/C<br>3. CATHODE 1<br>4. ANODE 1<br>5. N/C<br>6. CATHODE 2          |
| STYLE 7:<br>PIN 1. SOURCE 2<br>2. DRAIN 2<br>3. GATE 1<br>4. SOURCE 1<br>5. DRAIN 1<br>6. GATE 2           | STYLE 8:<br>CANCELLED  | STYLE 9:<br>PIN 1. EMITTER 2<br>2. EMITTER 1<br>3. COLLECTOR 1<br>4. BASE 1<br>5. BASE 2<br>6. COLLECTOR 2  | STYLE 10:<br>PIN 1. SOURCE 2<br>2. SOURCE 1<br>3. GATE 1<br>4. DRAIN 1<br>5. DRAIN 2<br>6. GATE 2           | STYLE 11:<br>PIN 1. CATHODE 2<br>2. CATHODE 2<br>3. ANODE 1<br>4. CATHODE 1<br>5. CATHODE 1<br>6. ANODE 2   | STYLE 12:<br>PIN 1. ANODE 2<br>2. ANODE 2<br>3. CATHODE 1<br>4. ANODE 1<br>5. ANODE 1<br>6. CATHODE 2 |
| STYLE 13:<br>PIN 1. ANODE<br>2. N/C<br>3. COLLECTOR<br>4. EMITTER<br>5. BASE<br>6. CATHODE                 | STYLE 14:<br>PIN 1. VREF<br>2. GND<br>3. GND<br>4. IOUT<br>5. VEN<br>6. VCC                            | STYLE 15:<br>PIN 1. ANODE 1<br>2. ANODE 2<br>3. ANODE 3<br>4. CATHODE 3<br>5. CATHODE 2<br>6. CATHODE 1     | STYLE 16:<br>PIN 1. BASE 1<br>2. EMITTER 2<br>3. COLLECTOR 2<br>4. BASE 2<br>5. EMITTER 1<br>6. COLLECTOR 1 | STYLE 17:<br>PIN 1. BASE 1<br>2. EMITTER 1<br>3. COLLECTOR 2<br>4. BASE 2<br>5. EMITTER 2<br>6. COLLECTOR 1 | STYLE 18:<br>PIN 1. VIN1<br>2. VCC<br>3. VOUT2<br>4. VIN2<br>5. GND<br>6. VOUT1                       |
| STYLE 19:<br>PIN 1. I OUT<br>2. GND<br>3. GND<br>4. V CC<br>5. V EN<br>6. V REF                            | STYLE 20:<br>PIN 1. COLLECTOR<br>2. COLLECTOR<br>3. BASE<br>4. EMITTER<br>5. COLLECTOR<br>6. COLLECTOR | STYLE 21:<br>PIN 1. ANODE 1<br>2. N/C<br>3. ANODE 2<br>4. CATHODE 2<br>5. N/C<br>6. CATHODE 1               | STYLE 22:<br>PIN 1. D1 (i)<br>2. GND<br>3. D2 (i)<br>4. D2 (c)<br>5. VBUS<br>6. D1 (c)                      | STYLE 23:<br>PIN 1. Vn<br>2. CH1<br>3. Vp<br>4. N/C<br>5. CH2<br>6. N/C                                     | STYLE 24:<br>PIN 1. CATHODE<br>2. ANODE<br>3. CATHODE<br>4. CATHODE<br>5. CATHODE<br>6. CATHODE       |
| STYLE 25:<br>PIN 1. BASE 1<br>2. CATHODE<br>3. COLLECTOR 2<br>4. BASE 2<br>5. EMITTER<br>6. COLLECTOR 1    | STYLE 26:<br>PIN 1. SOURCE 1<br>2. GATE 1<br>3. DRAIN 2<br>4. SOURCE 2<br>5. GATE 2<br>6. DRAIN 1      | STYLE 27:<br>PIN 1. BASE 2<br>2. BASE 1<br>3. COLLECTOR 1<br>4. EMITTER 1<br>5. EMITTER 2<br>6. COLLECTOR 2 | STYLE 28:<br>PIN 1. DRAIN<br>2. DRAIN<br>3. GATE<br>4. SOURCE<br>5. DRAIN<br>6. DRAIN                       | STYLE 29:<br>PIN 1. ANODE<br>2. ANODE<br>3. COLLECTOR<br>4. EMITTER<br>5. BASE/ANODE<br>6. CATHODE          | STYLE 30:<br>PIN 1. SOURCE 1<br>2. DRAIN 2<br>3. DRAIN 2<br>4. SOURCE 2<br>5. GATE 1<br>6. DRAIN 1    |

Note: Please refer to datasheet for style callout. If style type is not called out in the datasheet refer to the device datasheet pinout or pin assignment.

ON Semiconductor and  are trademarks of Semiconductor Components Industries, LLC dba ON Semiconductor or its subsidiaries in the United States and/or other countries. ON Semiconductor owns the rights to a number of patents, trademarks, copyrights, trade secrets, and other intellectual property. A listing of ON Semiconductor's product/patent coverage may be accessed at [www.onsemi.com/site/pdf/Patent-Marking.pdf](http://www.onsemi.com/site/pdf/Patent-Marking.pdf). ON Semiconductor reserves the right to make changes without further notice to any products herein. ON Semiconductor makes no warranty, representation or guarantee regarding the suitability of its products for any particular purpose, nor does ON Semiconductor assume any liability arising out of the application or use of any product or circuit, and specifically disclaims any and all liability, including without limitation special, consequential or incidental damages. Buyer is responsible for its products and applications using ON Semiconductor products, including compliance with all laws, regulations and safety requirements or standards, regardless of any support or applications information provided by ON Semiconductor. "Typical" parameters which may be provided in ON Semiconductor data sheets and/or specifications can and do vary in different applications and actual performance may vary over time. All operating parameters, including "Typicals" must be validated for each customer application by customer's technical experts. ON Semiconductor does not convey any license under its patent rights nor the rights of others. ON Semiconductor products are not designed, intended, or authorized for use as a critical component in life support systems or any FDA Class 3 medical devices or medical devices with a same or similar classification in a foreign jurisdiction or any devices intended for implantation in the human body. Should Buyer purchase or use ON Semiconductor products for any such unintended or unauthorized application, Buyer shall indemnify and hold ON Semiconductor and its officers, employees, subsidiaries, affiliates, and distributors harmless against all claims, costs, damages, and expenses, and reasonable attorney fees arising out of, directly or indirectly, any claim of personal injury or death associated with such unintended or unauthorized use, even if such claim alleges that ON Semiconductor was negligent regarding the design or manufacture of the part. ON Semiconductor is an Equal Opportunity/Affirmative Action Employer. This literature is subject to all applicable copyright laws and is not for resale in any manner.

## PUBLICATION ORDERING INFORMATION

LITERATURE FULFILLMENT:  
Email Requests to: [orderlit@onsemi.com](mailto:orderlit@onsemi.com)

TECHNICAL SUPPORT  
North American Technical Support:  
Voice Mail: 1 800-282-9855 Toll Free USA/Canada  
Phone: 011 421 33 790 2910

Europe, Middle East and Africa Technical Support:  
Phone: 00421 33 790 2910  
For additional information, please contact your local Sales Representative